

## Trisil™ for telecom equipment protection

### Features

- Bidirectional crowbar protection
- Voltage range from 62 V to 320 V
- Low capacitance from 12 pF to 20 pF @ 50 V
- Low leakage current :  $I_R = 2 \mu\text{A max}$
- Holding current:  $I_H = 150 \text{ mA min}$
- Repetitive peak pulse current :  
 $I_{PP} = 50 \text{ A (10/1000 } \mu\text{s)}$

### Main applications

Telecommunication equipment such as:

- Analog and digital line cards (xDSL, T1/E1, ISDN, ...)
- Terminals (phone, fax, modem, ...) and central office equipment

### Description

These Trisil series have been designed to protect telecommunication equipment against lightning and transient induced by AC power lines.

They are available in SMA, SMB and DO-15 packages.

### Benefits

Trisils are not subject to ageing and provide a fail safe mode in short circuit for a better protection. They are used to help equipment to meet various standards such as UL1950, IEC950 / CSA C22.2, UL1459 and FCC part 68.

Trisils have UL94 V0 approved resin. SMA and SMB packages are JEDEC registered (DO-214AC and DO-214AA).

Trisils are UL497B approved (file: E136224).

TM: TRISIL is a trademark of STMicroelectronics



### Order codes

Part Number	Marking
SMP50-xxx	See <a href="#">Ordering Information</a> on page 9
TPAxxx	
SMTPAxxx	

### Schematic Diagram

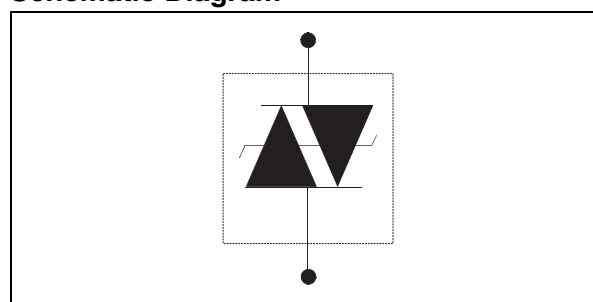

# 1 Characteristics

**Table 1. Compliant with the following standards**

Standard	Peak Surge Voltage (V)	Waveform Voltage	Required peak current (A)	Current waveform	Minimum serial resistor to meet standard (Ω)
GR-1089 Core First level	2500	2/10 μs	500	2/10 μs	20
	1000	10/1000 μs	100	10/1000 μs	10
GR-1089 Core Second level	5000	2/10 μs	500	2/10 μs	40
GR-1089 Core Intra-building	1500	2/10 μs	100	2/10 μs	0
ITU-T-K20/K21	6000	10/700 μs	150	5/310 μs	53
	1500		37.5		0
ITU-T-K20 (IEC61000-4-2)	8000	1/60 ns	ESD contact discharge		0
	15000		ESD air discharge		0
VDE0433	4000	10/700 μs	100	5/310 μs	21.5
	2000		50		0
VDE0878	4000	1.2/50 μs	100	1/20 μs	0
	2000		50		0
IEC61000-4-5	4000	10/700 μs	100	5/310 μs	21.5
	4000	1.2/50 μs	100	8/20 μs	0
FCC Part 68, lightning surge type A	1500	10/160 μs	200	10/160 μs	12.5
	800	10/560 μs	100	10/560 μs	6.5
FCC Part 68, lightning surge type B	1000	9/720 μs	25	5/320 μs	0

**Table 2. Absolute ratings (T<sub>amb</sub> = 25° C)**

Symbol	Parameter	Value	Unit	
I <sub>PP</sub>	Repetitive peak pulse current (see <a href="#">Figure 1</a> )	10/1000 μs	50	A
		8/20 μs	150	
		10/560 μs	55	
		5/310 μs	65	
		10/160 μs	75	
		1/20 μs	100	
I <sub>FS</sub>	Fail-safe mode : maximum current <sup>(1)</sup>	8/20 μs	2.5	kA
I <sub>TSM</sub>	Non repetitive surge peak on-state current (sinusoidal)	t = 0.2 s	16	A
		t = 1 s	11.5	
		t = 2 s	10	
		t = 15 mn	3.5	
I <sup>2</sup> t	I <sup>2</sup> t value for fusing	t = 16.6 ms	6.2	A <sup>2</sup> s
		t = 20 ms	6.5	
T <sub>stg</sub>	Storage temperature range	-55 to 150	°C	
T <sub>j</sub>	Maximum junction temperature	150	°C	
T <sub>L</sub>	Maximum lead temperature for soldering during 10 s.	260	°C	

1. in fail safe mode, the device acts as a short circuit

**Table 3. Thermal resistances**

Symbol	Parameter	Value			Unit
		DO-15	SMA	SMB	
$R_{th(j-a)}$	Junction to ambient (with recommended footprint or with $L_{lead} = 10$ mm for DO-15)	100	120	100	$^{\circ}C/W$
$R_{th(j-l)}$	Junction to leads ( $L_{lead} = 10$ mm for DO-15)	60	30	20	$^{\circ}C/W$

**Table 4. Electrical characteristics - definitions ( $T_{amb} = 25^{\circ}C$ )**

Symbol	Parameter
$V_{RM}$	Stand-off voltage
$V_{BR}$	Breakdown voltage
$V_{BO}$	Breakover voltage
$I_{RM}$	Leakage current
$I_{PP}$	Peak pulse current
$I_{BO}$	Breakover current
$I_H$	Holding current
$V_R$	Continuous reverse voltage
$I_R$	Leakage current at $V_R$
C	Capacitance

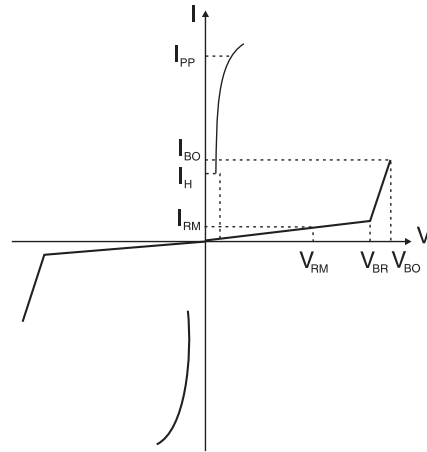

**Table 5. Electrical characteristics - values ( $T_{amb} = 25^{\circ}C$ )**

Types	$I_{RM} @ V_{RM}$		$I_R @ V_R^{(1)}$		Dynamic $V_{BO}^{(2)}$	Static $V_{BO} @ I_{BO}^{(3)}$		$I_H^{(4)}$	$C^{(5)}$	$C^{(6)}$
	max.		max.		max.	max.	max.	min.	typ.	typ.
	$\mu A$	V	$\mu A$	V	V	V	mA	mA	pF	pF
SMP50-62 / TPA62 SMTPA62		56		62	85	82			20	40
SMP50-68 / TPA68 SMTPA68		61		68	93	90			20	40
SMP50-100 / TPA100 SMTPA100		90		100	135	133			16	35
SMP50-120 / TPA120 SMTPA120		108		120	160	160			16	30
SMP50-130 / TPA130 SMTPA130		117		130	173	173			14	30
SMP50-180 / TPA180 SMTPA180	2	162	5	180	235	240	800	150	14	25
SMP50-200 / TPA200 SMTPA200		180		200	262	267			12	25
SMP50-220 / TPA220 SMTPA220		198		220	285	293			12	25
SMP50-240 / TPA240 SMTPA240		216		240	300	320			12	25
SMP50-270 / TPA270 SMTPA270		243		270	350	360			12	25
SMP50-320 / SMTPA320		290		320	400	400			12	25

1.  $I_R$  measured at  $V_R$  guarantee  $V_{BR} \min \geq V_R$
2. See functional test circuit 1(Figure 9.)
3. See test circuit 2(Figure 10.)
4. See functional holding current test circuit 3(Figure 11.)
5.  $V_R = 50 V$  bias,  $V_{RMS} = 1 V$ ,  $F = 1 MHz$
6.  $V_R = 2 V$  bias,  $V_{RMS} = 1 V$ ,  $F = 1 MHz$

**Figure 1. Pulse waveform (10/1000  $\mu s$ )**



**Figure 2. Non repetitive surge peak on-state current versus overload duration**



**Figure 3. On-state voltage versus on-state current (typical values)**

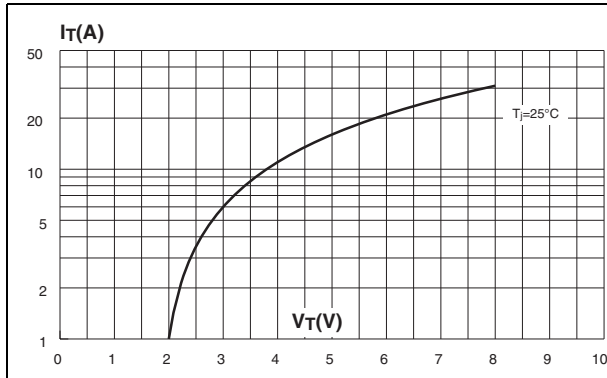

**Figure 4. Relative variation of holding current versus junction temperature**

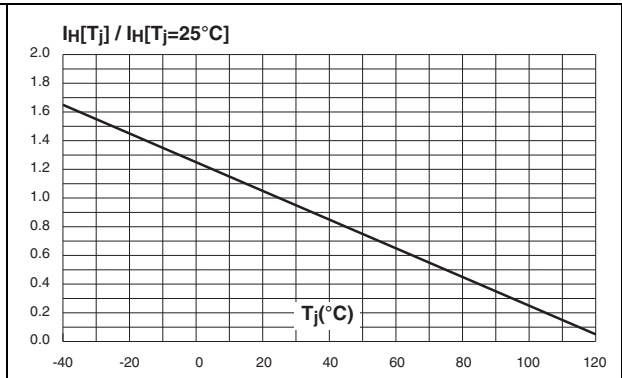

**Figure 5. Relative variation of breakover voltage versus junction temperature**

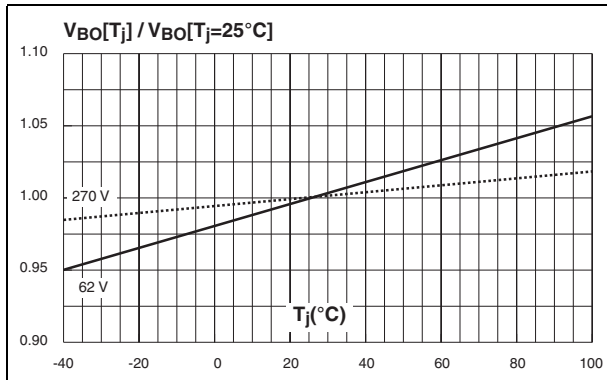

**Figure 6. Relative variation of leakage current versus reverse voltage applied (typical values)**

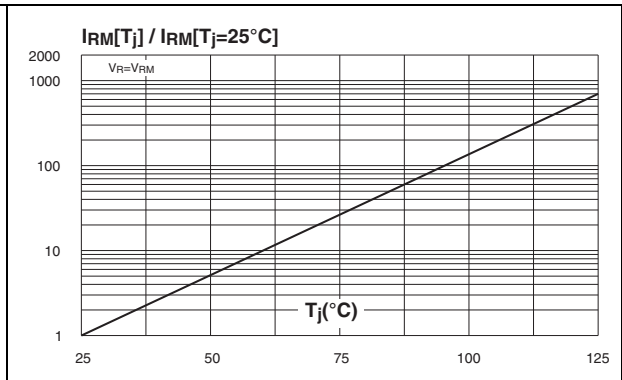

**Figure 7. Variation of thermal impedance junction to ambient versus pulse duration (Printed circuit board FR4, SCu = 35 μm, recommended pad layout)**

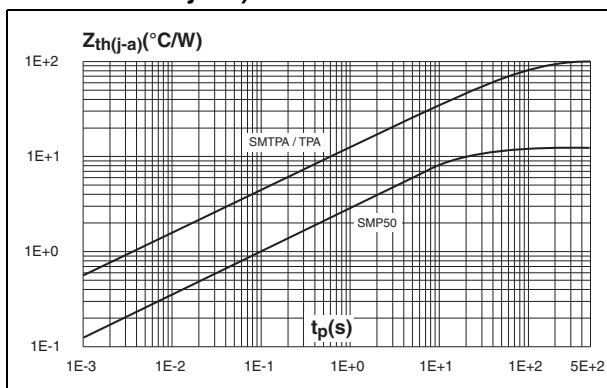

**Figure 8. Relative variation of junction capacitance versus reverse voltage applied (typical values)**

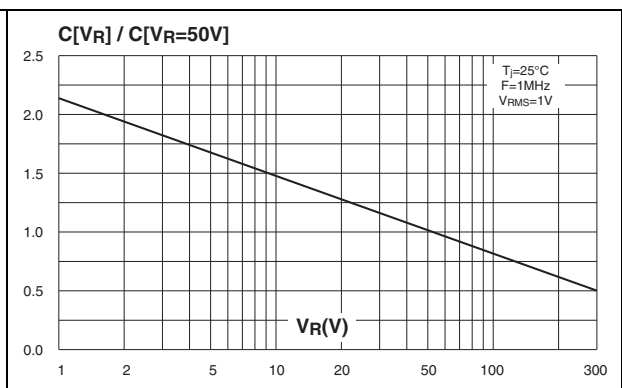

**Figure 9. Test circuit 1 for Dynamic  $I_{BO}$  and  $V_{BO}$  parameters**



**Figure 10. Test circuit 2 for  $I_{BO}$  and  $V_{BO}$  parameters**

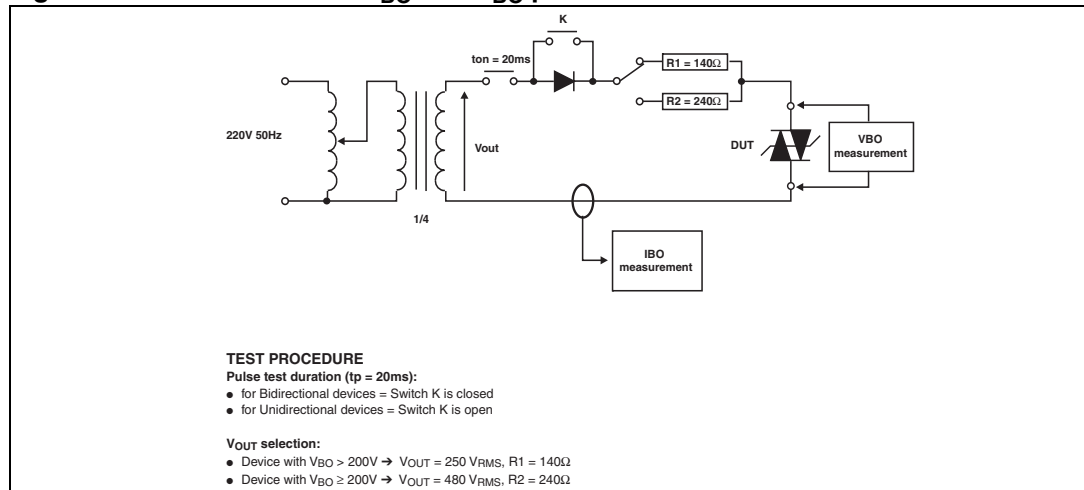

**Figure 11. Test circuit 3 for dynamic  $I_H$  parameters**



## 2 Ordering information scheme



## 3 Package information

- Epoxy meets UL94, V0

**Table 6. SMA dimensions**

Ref.	Dimensions			
	Millimeters		Inches	
	Min.	Max.	Min.	Max.
A1	1.90	2.45	0.075	0.094
A2	0.05	0.20	0.002	0.008
b	1.25	1.65	0.049	0.065
c	0.15	0.40	0.006	0.016
D	2.25	2.90	0.089	0.114
E	4.80	5.35	0.189	0.211
E1	3.95	4.60	0.156	0.181
L	0.75	1.50	0.030	0.059

**Figure 12. Footprint, dimensions in mm (inches)**

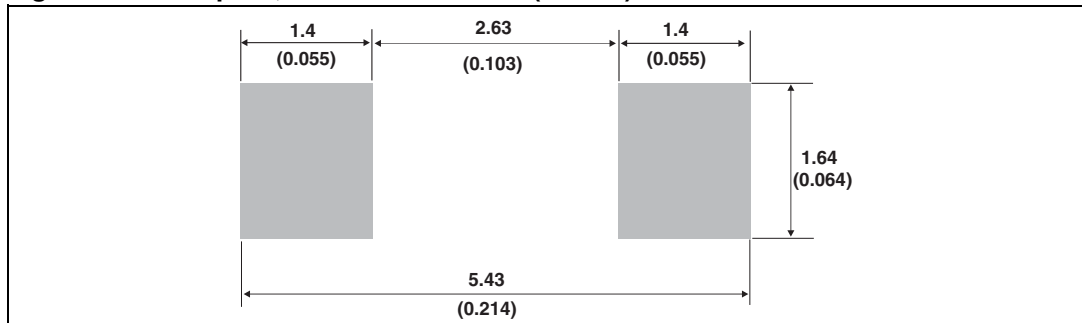

**Table 7. SMB dimensions**

Ref.	Dimensions			
	Millimeters		Inches	
	Min.	Max.	Min.	Max.
A1	1.90	2.45	0.075	0.096
A2	0.05	0.20	0.002	0.008
b	1.95	2.20	0.077	0.087
c	0.15	0.40	0.006	0.016
E	5.10	5.60	0.201	0.220
E1	4.05	4.60	0.159	0.181
D	3.30	3.95	0.130	0.156
L	0.75	1.50	0.030	0.059

**Figure 13. Footprint, dimensions in mm (inches)**

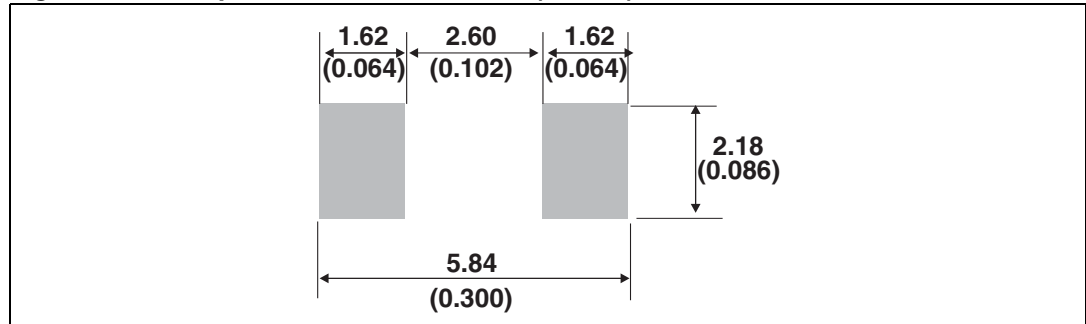

**Table 8. DO-15 dimensions**

Ref.	Dimensions			
	Millimeters		Inches	
	Min.	Max.	Min.	Max.
A	6.05	6.75	0.238	0.266
B	2.95	3.53	0.116	0.139
C	26	31	1.024	1.220
D	0.71	0.88	0.028	0.035

In order to meet environmental requirements, ST offers these devices in ECOPACK® packages. These packages have a lead-free second level interconnect. The category of second level interconnect is marked on the package and on the inner box label, in compliance with JEDEC Standard JESD97. The maximum ratings related to soldering conditions are also marked on the inner box label. ECOPACK is an ST trademark. ECOPACK specifications are available at: [www.st.com](http://www.st.com).



## 4 Ordering Information

Part Number	Marking	Package	Weight	Base qty	Delivery mode
SMP50-62	V06	SMA	0.068 g	5000	Tape & reel
SMP50-68	V07				
SMP50-100	V10				
SMP50-120	V12				
SMP50-130	V13				
SMP50-180	V18				
SMP50-200	V20				
SMP50-220	V22				
SMP50-240	V24				
SMP50-270	V27				
SMP50-320	V32				
SMTPA62	U01				
SMTPA68	U05				
SMTPA100	U13				
SMTPA120	U17				
SMTPA130	U19				
SMTPA180	U25				
SMTPA200	U27				
SMTPA220	U31				
SMTPA240	U35				
SMTPA270	U39				
SMTPA320	U47				
TPA62	TPA62	DO-15	0.40 g	1000	Ammopack
TPA62RL				6000	Tape & reel
TPA68	TPA68			1000	Ammopack
TPA68RL				6000	Tape & reel
TPA100	TPA100			1000	Ammopack
TPA100RL				6000	Tape & reel
TPA120	TPA120			1000	Ammopack
TPA130	TPA130			1000	Ammopack
TPA130RL				6000	Tape & reel
TPA180	TPA180			1000	Ammopack
TPA180RL				6000	Tape & reel
TPA200	TPA200			1000	Ammopack
TPA200RL				6000	Tape & reel
TPA220	TPA220			1000	Ammopack
TPA220RL				6000	Tape & reel
TPA240	TPA240			1000	Ammopack
TPA240RL				6000	Tape & reel
TPA270	TPA270			1000	Ammopack
TPA270RL				6000	Tape & reel

## 5 Revision History

Date	Revision	Description of Changes
16-Nov-2004	1	SMP50, SMTPA and TPA datasheets merge.
30-Mar-2007	2	Reformatted to current standards. Updated $I_{PP}$ value in Table 2 . Added part numbers SMP50-320 and SMTPA320. Updated dimensions and footprint for SMA and footprint for SMB.
12-Jun-2007	3	Corrected typographical error in part number. Added dimensions in inches to footprint illustrations.

**Please Read Carefully:**

Information in this document is provided solely in connection with ST products. STMicroelectronics NV and its subsidiaries ("ST") reserve the right to make changes, corrections, modifications or improvements, to this document, and the products and services described herein at any time, without notice.

All ST products are sold pursuant to ST's terms and conditions of sale.

Purchasers are solely responsible for the choice, selection and use of the ST products and services described herein, and ST assumes no liability whatsoever relating to the choice, selection or use of the ST products and services described herein.

No license, express or implied, by estoppel or otherwise, to any intellectual property rights is granted under this document. If any part of this document refers to any third party products or services it shall not be deemed a license grant by ST for the use of such third party products or services, or any intellectual property contained therein or considered as a warranty covering the use in any manner whatsoever of such third party products or services or any intellectual property contained therein.

**UNLESS OTHERWISE SET FORTH IN ST'S TERMS AND CONDITIONS OF SALE ST DISCLAIMS ANY EXPRESS OR IMPLIED WARRANTY WITH RESPECT TO THE USE AND/OR SALE OF ST PRODUCTS INCLUDING WITHOUT LIMITATION IMPLIED WARRANTIES OF MERCHANTABILITY, FITNESS FOR A PARTICULAR PURPOSE (AND THEIR EQUIVALENTS UNDER THE LAWS OF ANY JURISDICTION), OR INFRINGEMENT OF ANY PATENT, COPYRIGHT OR OTHER INTELLECTUAL PROPERTY RIGHT.**

**UNLESS EXPRESSLY APPROVED IN WRITING BY AN AUTHORIZED ST REPRESENTATIVE, ST PRODUCTS ARE NOT RECOMMENDED, AUTHORIZED OR WARRANTED FOR USE IN MILITARY, AIR CRAFT, SPACE, LIFE SAVING, OR LIFE SUSTAINING APPLICATIONS, NOR IN PRODUCTS OR SYSTEMS WHERE FAILURE OR MALFUNCTION MAY RESULT IN PERSONAL INJURY, DEATH, OR SEVERE PROPERTY OR ENVIRONMENTAL DAMAGE. ST PRODUCTS WHICH ARE NOT SPECIFIED AS "AUTOMOTIVE GRADE" MAY ONLY BE USED IN AUTOMOTIVE APPLICATIONS AT USER'S OWN RISK.**

Resale of ST products with provisions different from the statements and/or technical features set forth in this document shall immediately void any warranty granted by ST for the ST product or service described herein and shall not create or extend in any manner whatsoever, any liability of ST.

ST and the ST logo are trademarks or registered trademarks of ST in various countries.

Information in this document supersedes and replaces all information previously supplied.

The ST logo is a registered trademark of STMicroelectronics. All other names are the property of their respective owners.

© 2007 STMicroelectronics - All rights reserved

STMicroelectronics group of companies

Australia - Belgium - Brazil - Canada - China - Czech Republic - Finland - France - Germany - Hong Kong - India - Israel - Italy - Japan - Malaysia - Malta - Morocco - Singapore - Spain - Sweden - Switzerland - United Kingdom - United States of America

[www.st.com](http://www.st.com)



Компания «ЭлектроПласт» предлагает заключение долгосрочных отношений при поставках импортных электронных компонентов на взаимовыгодных условиях!

Наши преимущества:

- Оперативные поставки широкого спектра электронных компонентов отечественного и импортного производства напрямую от производителей и с крупнейших мировых складов;
- Поставка более 17-ти миллионов наименований электронных компонентов;
- Поставка сложных, дефицитных, либо снятых с производства позиций;
- Оперативные сроки поставки под заказ (от 5 рабочих дней);
- Экспресс доставка в любую точку России;
- Техническая поддержка проекта, помощь в подборе аналогов, поставка прототипов;
- Система менеджмента качества сертифицирована по Международному стандарту ISO 9001;
- Лицензия ФСБ на осуществление работ с использованием сведений, составляющих государственную тайну;
- Поставка специализированных компонентов (Xilinx, Altera, Analog Devices, Intersil, Interpoint, Microsemi, Aeroflex, Peregrine, Syfer, Eurofarad, Texas Instrument, Miteq, Cobham, E2V, MA-COM, Hittite, Mini-Circuits, General Dynamics и др.);

Помимо этого, одним из направлений компании «ЭлектроПласт» является направление «Источники питания». Мы предлагаем Вам помощь Конструкторского отдела:

- Подбор оптимального решения, техническое обоснование при выборе компонента;
- Подбор аналогов;
- Консультации по применению компонента;
- Поставка образцов и прототипов;
- Техническая поддержка проекта;
- Защита от снятия компонента с производства.



#### Как с нами связаться

**Телефон:** 8 (812) 309 58 32 (многоканальный)

**Факс:** 8 (812) 320-02-42

**Электронная почта:** [org@eplast1.ru](mailto:org@eplast1.ru)

**Адрес:** 198099, г. Санкт-Петербург, ул. Калинина, дом 2, корпус 4, литера А.