

Powered by



# XHRL12360W ▶ 12V 360W

XHRL 12360W is specially designed for high efficient discharge and long life application. Its characteristics are high energy density , small footprint and high discharge efficiency. It can be used for more than 260 cycles at 100% discharge in cycle service, up to 10 years in standby service.



## ► Specification

Cells per unit	6
Voltage per unit	12
Capacity	360W @15 min-rate to 1.67V per cell @25°C (77°F)
Weight	Approx. 27.5 kg (60.63 lbs)
Maximum Discharge Current	800A(5sec)
Internal Resistance	Approx. 4mΩ
Operating Temperature Range	Discharge: -20°C~50°C (-4°F~122°F) Charge: -20°C~50°C (-4°F~122°F) Storage: -15°C~40°C (5°F~104°F)
Nominal Operating Temperature Range	25°C ±3°C (77°F ±5°F)
Float Charging Voltage	13.5 to 13.8 VDC/unit Average at 25°C (77°F)
Recommended Maximum Charging Current Limit	36 A
Equalization and Cycle Service	14.4 to 15.0 VDC/unit Average at 25°C (77°F)
Self Discharge	CSB Batteries can be stored for more than 6 months at 25°C(77°F). Please charge batteries before using. For higher temperatures the time interval will be shorter.
Terminal	I2-Thread lead alloy recessed terminal to accept M6/M8 bolt
Container Material	Polypropylene(UL 94-HB) & Flammability resistance of (UL 94-V0) can be available upon request.



CSB-manufactured **VRLA** (Absorbent Glass Mat type) batteries are UL-recognized components under UL1989.

CSB is also certified by ISO 9001 and ISO 14001.

## ► Dimensions :

Overall Height (H)	Container height (h)	Length (L)	Width (W)
Unit: mm (inch)	213.9±2.5 (8.42±0.10)	210.5±2.5 (8.29±0.10)	261.0±2.5 (10.28±0.10) 168.5±2 (6.64±0.08)

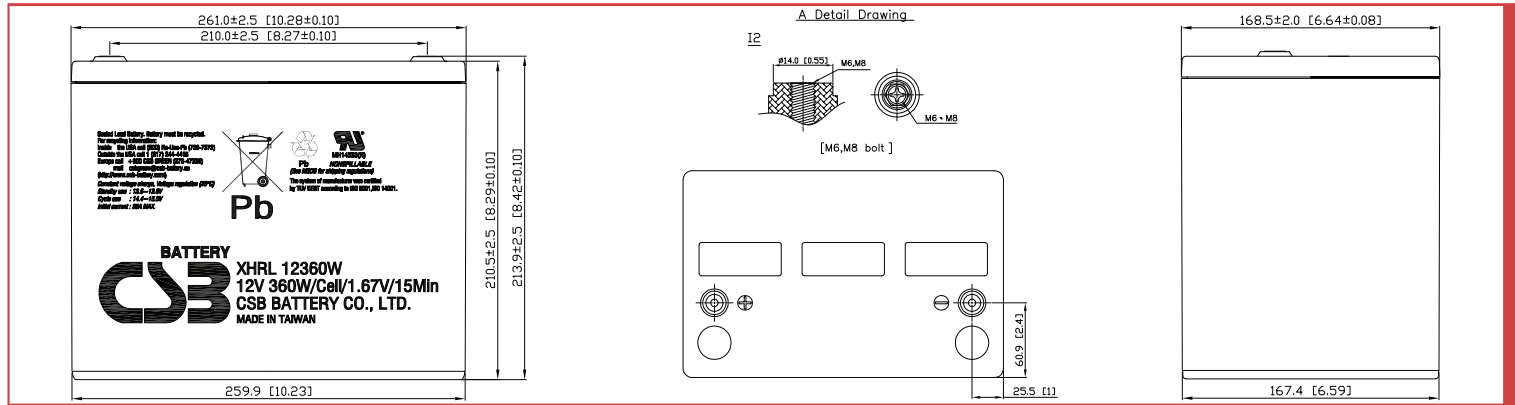

## Constant Current Discharge Characteristics Unit:A (25°C, 77°F)

F.V/Time	2MIN	4MIN	6MIN	8MIN	10MIN	15MIN	20MIN	30MIN	60MIN	90MIN
1.60V	468	383	319	273	239	182	145	104	57.3	40.4
1.67V	405	352	300	257	228	176	142	102	56.9	40.3
1.70V	373	324	290	252	221	173	139	101	56.5	40.1
1.75V	347	299	267	234	210	165	133	98.4	55.4	39.4
1.80V	319	284	244	214	194	152	125	92.8	54.0	38.5
1.85V	281	238	208	192	174	139	115	86.9	50.3	34.7

## Constant Power Discharge Characteristics Unit:W (25°C, 77°F)

F.V/Time	2MIN	4MIN	6MIN	8MIN	10MIN	15MIN	20MIN	30MIN	60MIN	90MIN
1.60V	4,544	3,982	3,529	3,081	2,758	2,198	1,735	1,232	678	485
1.67V	4,125	3,665	3,339	2,956	2,646	2,160	1,711	1,209	676	480
1.70V	3,850	3,516	3,203	2,830	2,530	2,080	1,664	1,184	668	477
1.75V	3,593	3,327	3,073	2,677	2,400	1,986	1,597	1,160	658	468
1.80V	3,376	3,020	2,777	2,476	2,240	1,858	1,514	1,102	644	459
1.85V	2,750	2,571	2,436	2,232	2,016	1,686	1,365	1,029	598	434

Ratings presented herein are subject to revision without notice. Please refer to [www.csb-battery.com](http://www.csb-battery.com) to confirm the latest version.

### Trickle (or Float) Service Life

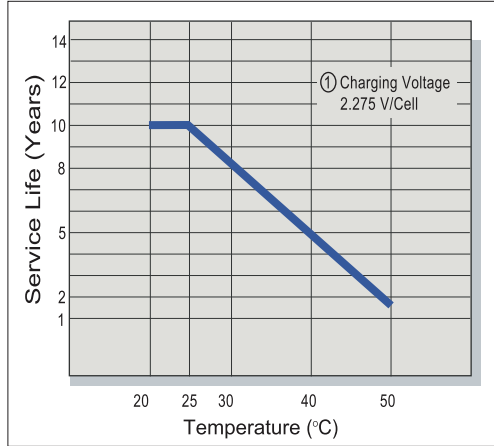

### Capacity Retention Characteristic

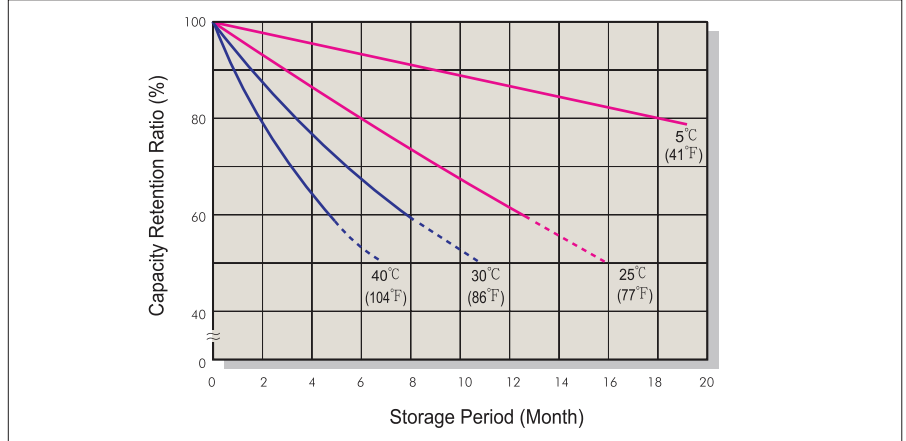

### Battery Voltage and Charge Time for Standby Use

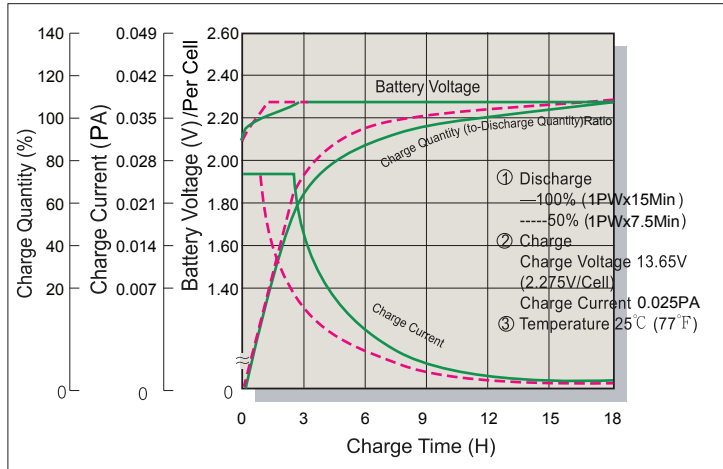

### Cycle Service Life

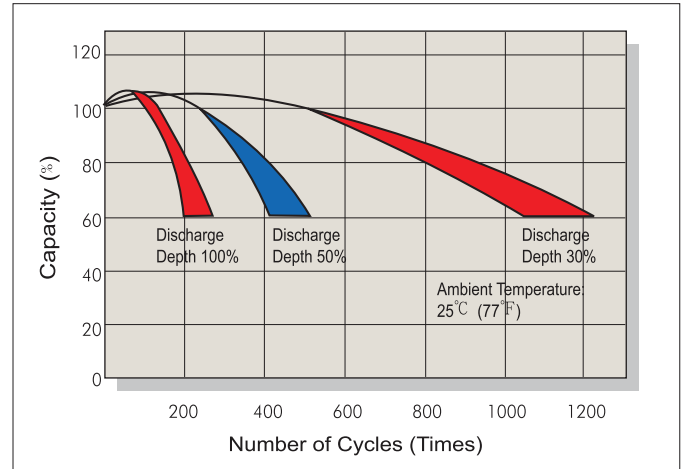

### Battery Voltage and Charge Time for Cycle Use

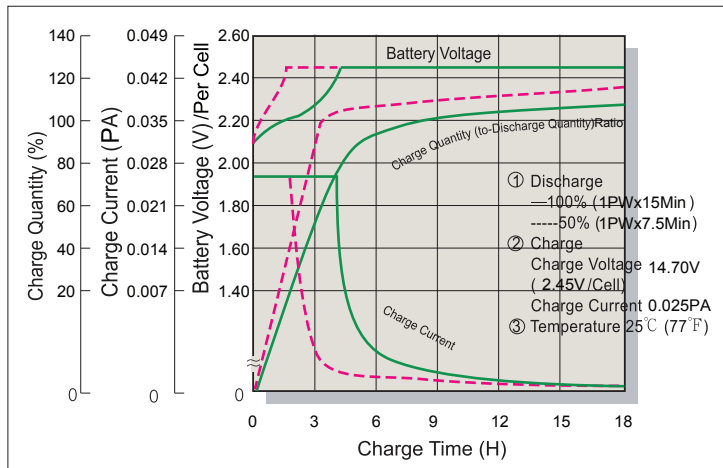

### Terminal Voltage (V) and Discharge Time

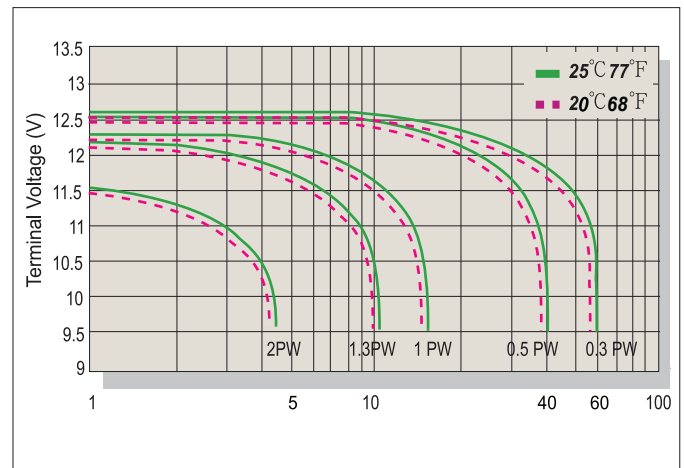

### Charging Procedures

Application	Charge Voltage(V/Cell)			Max.Charge Current
	Temperature	Set Point	Allowable Range	
Cycle Use	25°C(77°F)	2.45	2.40~2.50	0.1PA
Standby	25°C(77°F)	2.275	2.25~2.30	

### Discharge Current VS. Discharge Voltage

Final Discharge Voltage V/Cell	1.75	1.70	1.60	1.30
Discharge Power(W)	0.1P>(W)	0.1P≤(W)<0.25P	0.25P≤(W)<1.0P	(W)≥1.0P

Sales Office URL: [WWW.CSB-BATTERY.COM](http://WWW.CSB-BATTERY.COM)

**GLOBAL HQ**  
**CSB BATTERY CO., LTD. (TAIWAN)**  
 Tel : +886-2-2880-5600  
 Fax : +886-2-2888-3300  
 mail : service@csb-battery.com.tw

**BEIJING OFFICE. (CHINA)**  
**CSB BATTERY TECHNOLOGIES (BEIJING) CO., LTD.**  
 Tel : +86-10-5820-5336/5338  
 Fax : +86-10-58203053  
 mail : chinasl@csb-battery.com

**AMERICA HQ**  
**CSB BATTERY TECHNOLOGIES INC. (U.S.A)**  
 Tel : +1-817-244-7777/1-(800)3-CSB-USA(272872)  
 Fax : +1-817-244-4445  
 mail : csb@csb-battery.com

**SHANGHAI OFFICE. (CHINA)**  
**CSB BATTERY LOGISTIC (SHANGHAI) CO., LTD.**  
 Tel : +86-21-5046-1622/5046-0833  
 Fax : +86-21-5064-1046  
 mail : chinasl@csb-battery.com

**EUROPE HQ**  
**CSB Battery Europe BV.**  
 Tel : +31(0)-180-418-140  
 Fax : +31(0)-180-418-327  
 mail : eurosales@csb-battery.eu

**SHENZHEN OFFICE. (CHINA)**  
**CSB BATTERY LOGISTIC (SHANGHAI) CO., LTD.**  
 Tel : +86-755-8831-6488/6396/6356  
 Fax : +86-755-8831-6548  
 mail : she@csb-battery.com.cn



Компания «ЭлектроПласт» предлагает заключение долгосрочных отношений при поставках импортных электронных компонентов на взаимовыгодных условиях!

Наши преимущества:

- Оперативные поставки широкого спектра электронных компонентов отечественного и импортного производства напрямую от производителей и с крупнейших мировых складов;
- Поставка более 17-ти миллионов наименований электронных компонентов;
- Поставка сложных, дефицитных, либо снятых с производства позиций;
- Оперативные сроки поставки под заказ (от 5 рабочих дней);
- Экспресс доставка в любую точку России;
- Техническая поддержка проекта, помощь в подборе аналогов, поставка прототипов;
- Система менеджмента качества сертифицирована по Международному стандарту ISO 9001;
- Лицензия ФСБ на осуществление работ с использованием сведений, составляющих государственную тайну;
- Поставка специализированных компонентов (Xilinx, Altera, Analog Devices, Intersil, Interpoint, Microsemi, Aeroflex, Peregrine, Syfer, Eurofarad, Texas Instrument, Miteq, Cobham, E2V, MA-COM, Hittite, Mini-Circuits, General Dynamics и др.);

Помимо этого, одним из направлений компании «ЭлектроПласт» является направление «Источники питания». Мы предлагаем Вам помощь Конструкторского отдела:

- Подбор оптимального решения, техническое обоснование при выборе компонента;
- Подбор аналогов;
- Консультации по применению компонента;
- Поставка образцов и прототипов;
- Техническая поддержка проекта;
- Защита от снятия компонента с производства.



#### Как с нами связаться

**Телефон:** 8 (812) 309 58 32 (многоканальный)

**Факс:** 8 (812) 320-02-42

**Электронная почта:** [org@eplast1.ru](mailto:org@eplast1.ru)

**Адрес:** 198099, г. Санкт-Петербург, ул. Калинина, дом 2, корпус 4, литера А.