

# Multilayer Band Pass Filters(Balance Output Type)

For 2.4GHz W-LAN/Bluetooth

## DEA Series

Type:            **DEA202450BT-7171A1 (2.0×1.25×0.6mm max.)**  
                     **DEA202450BT-7190A1 (2.0×1.25×0.6mm max.)**  
                     **DEA202450BT-7099A1 (2.0×1.25×0.8mm max.)**  
                     **DEA202450BT-7100C1 (2.0×1.25×0.8mm max.)**  
                     **DEA202350BT-7196A1 (2.0×1.25×0.9mm)**  
                     **DEA202450BT-7077A1 (2.0×1.25×0.95mm)**  
                     **DEA202450BT-7089C3 (2.0×1.25×1.0mm max.)**  
                     **DEA202450BT-7112B1 (2.0×1.25×1.0mm max.)**  
                     **DEA202450BT-7112E1 (2.0×1.25×1.0mm max.)**

Issue date:     December 2010

- All specifications are subject to change without notice.
  - Conformity to RoHS Directive: This means that, in conformity with EU Directive 2002/95/EC, lead, cadmium, mercury, hexavalent chromium, and specific bromine-based flame retardants, PBB and PBDE, have not been used, except for exempted applications.
-

# Multilayer Chip Band Pass Filters(Balance Output Type) Conformity to RoHS Directive For Bluetooth & 2.4GHz W-LAN

DEA Series DEA202450BT-7171A1

### FEATURES

- Miniature balanced band pass filter.
- Matched to  $34+j60\Omega$ .
- Package size:  $2.0 \times 1.25\text{mm}$ .
- Low profile : 0.6mm max. height.

### SHAPES AND DIMENSIONS

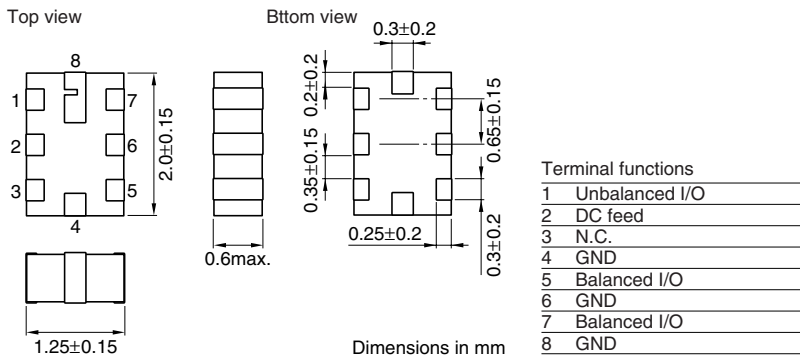

### RECOMMENDED PC BOARD PATTERNS

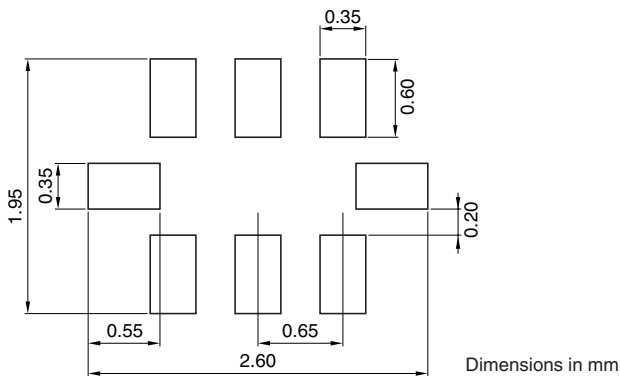

- Note 1: Pin 2 of the filter provides a DC feed connection to the balanced ports. In the event that this function is used, pin 2 should be connected to ground using a de-coupling capacitor.
- Note 2: In the event that the pin 2 function is not used, the pin should be left unconnected.

### EVALUATION SETUP

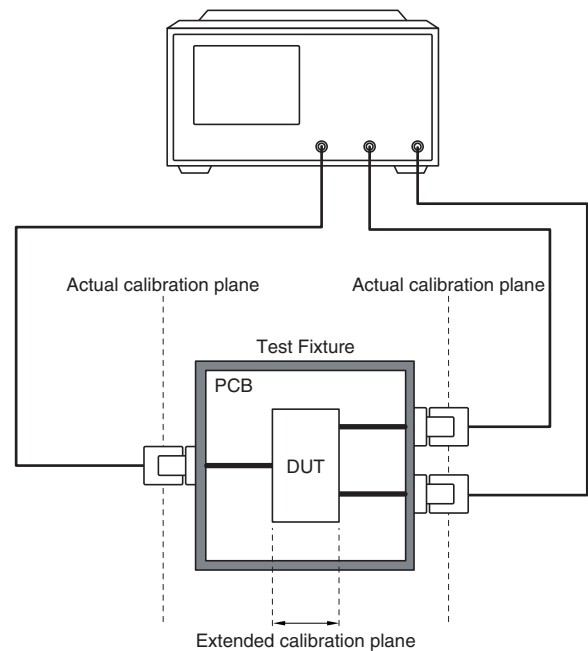

- Note 1: The Port Extension function on the Network Analyser is used to extend the calibration plane to the DUT terminals.
- Note 2: Loss in the PCB traces is compensated for by measurement data taken on a PCB Thru' line.

• Conformity to RoHS Directive: This means that, in conformity with EU Directive 2002/95/EC, lead, cadmium, mercury, hexavalent chromium, and specific bromine-based flame retardants, PBB and PBDE, have not been used, except for exempted applications.

• All specifications are subject to change without notice.

### ELECTRICAL CHARACTERISTICS

Insertion Loss	[2402 to 2480MHz]	3.0dB max.
Single ended port characteristic impedance	—	50Ω (Nominal)
Balanced ports impedance, nominal value	—	34 + j60Ω
VSWR: Unbalanced port	[2402 to 2480MHz]	2max.
VSWR: Balanced port (with respect to nominal balanced impedance)	[2402 to 2480MHz]	2max.
Attenuation	[880 to 960MHz]	35dB min.
	[1710 to 1880MHz]	22dB min.
	[1880 to 1910MHz]	20dB min.
	[2110 to 2170MHz]	—
Phase difference at balanced port	[4804 to 4960MHz]	18dB min.
	[2402 to 2480MHz]	180±10.0°
Amplitude imbalance at balanced port	[2402 to 2480MHz]	0±2dB
Temperature range	Operating	-40 to +85°C
	Storage	-40 to +85°C

### FREQUENCY CHARACTERISTICS

#### SDS21 INSERTION LOSS

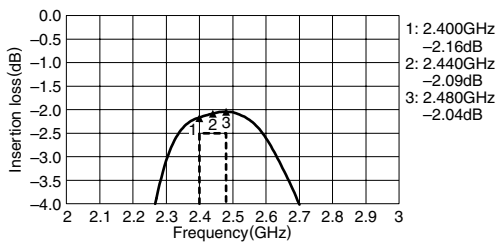

#### SDS21 ATTENUATION

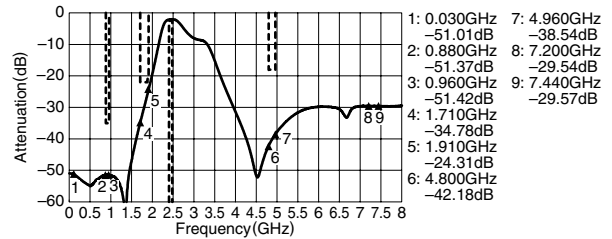

#### AMPLITUDE IMBALANCE

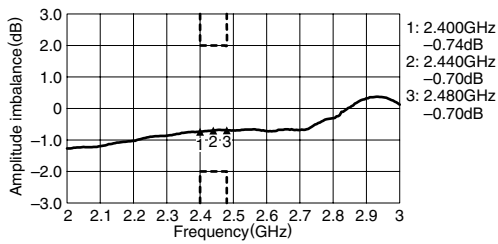

#### PHASE IMBALANCE

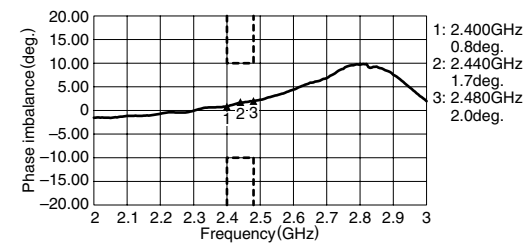

#### SSS11 VSWR

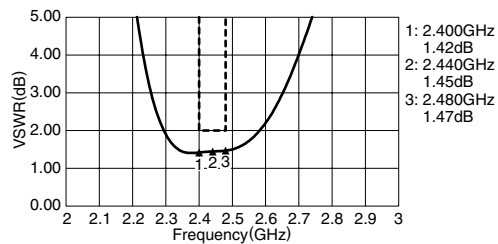

#### SDD22 VSWR

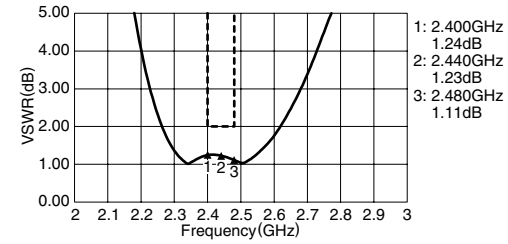

### SMITH CHARTS

#### SSS11

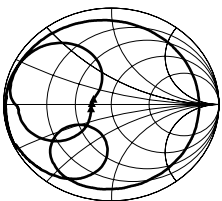

#### SDD22

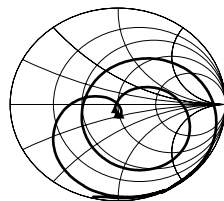

**PACKAGING STYLES**  
**REEL DIMENSIONS**

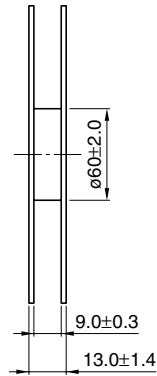
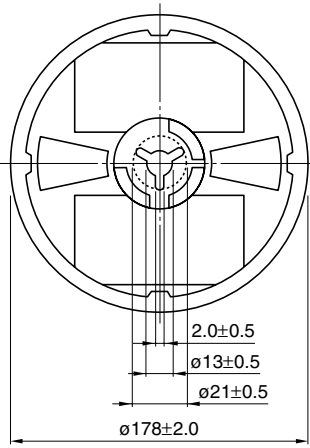

Standard package quantities: 2000pcs/reel  
Dimensions in mm

**TAPE DIMENSIONS**

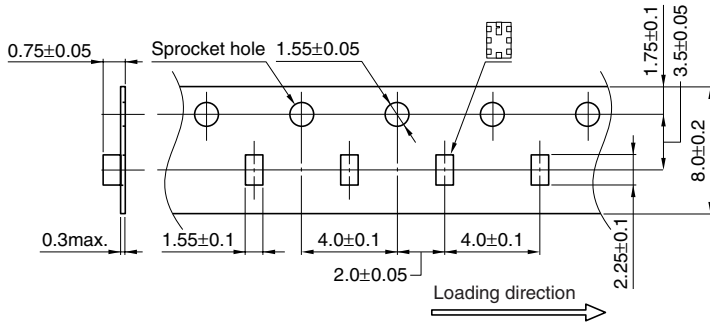

Dimensions in mm

• All specifications are subject to change without notice.

# Multilayer Chip Band Pass Filters(Balance Output Type) Conformity to RoHS Directive

## For Bluetooth & 2.4GHz W-LAN

DEA Series DEA202450BT-7190A1

### FEATURES

- Miniature balanced band pass filter.
- Matched to  $34+j60\Omega$ .
- Package size:  $2.0 \times 1.25\text{mm}$ .
- Low profile : 0.6mm max. height.

### SHAPES AND DIMENSIONS

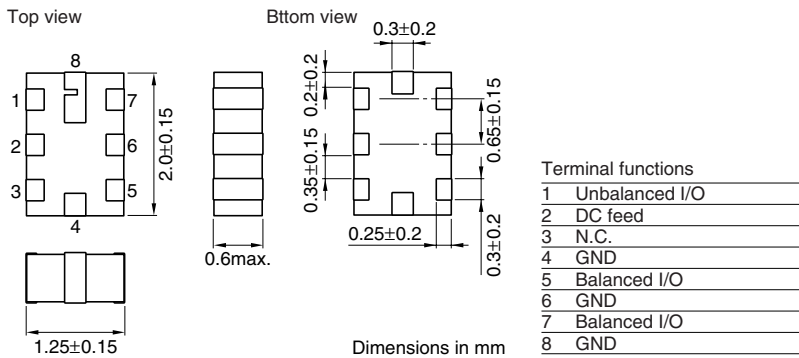

### RECOMMENDED PC BOARD PATTERNS

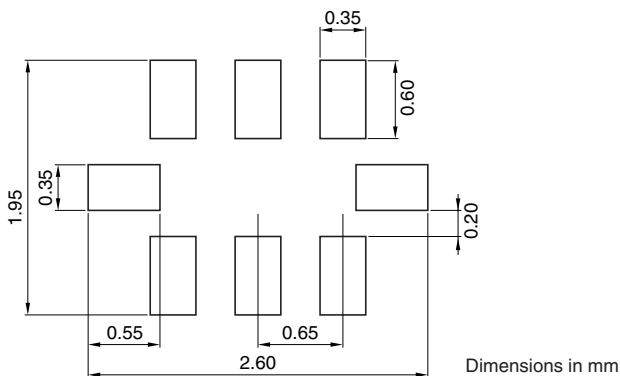

Note 1: Pin 2 of the filter provides a DC feed connection to the balanced ports.

In the event that this function is used, pin 2 should be connected to ground using a de-coupling capacitor.

Note 2: In the event that the pin 2 function is not used, the pin should be left unconnected.

### EVALUATION SETUP

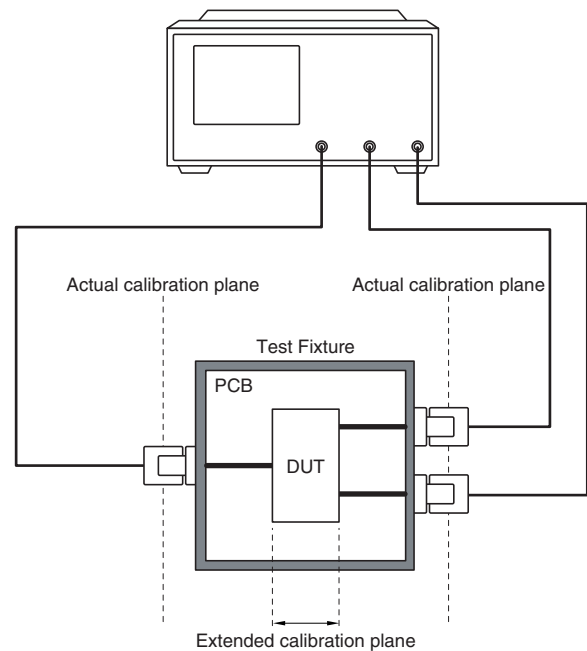

Note 1: The Port Extension function on the Network Analyser is used to extend the calibration plane to the DUT terminals.

Note 2: Loss in the PCB traces is compensated for by measurement data taken on a PCB Thru' line.

• Conformity to RoHS Directive: This means that, in conformity with EU Directive 2002/95/EC, lead, cadmium, mercury, hexavalent chromium, and specific bromine-based flame retardants, PBB and PBDE, have not been used, except for exempted applications.

• All specifications are subject to change without notice.

**ELECTRICAL CHARACTERISTICS**

Insertion Loss	[2402 to 2480MHz]	3.0dB max.
Single ended port characteristic impedance	—	50Ω (Nominal)
Balanced ports impedance, nominal value	—	34 + j60Ω
VSWR: Unbalanced port	[2402 to 2480MHz]	2max.
VSWR: Balanced port (with respect to nominal balanced impedance)	[2402 to 2480MHz]	2max.
Attenuation	[880 to 960MHz]	35dB min.
	[1710 to 1880MHz]	22dB min.
	[1880 to 1910MHz]	20dB min.
	[2110 to 2170MHz]	—
	[4804 to 4960MHz]	18dB min.
Phase difference at balanced port	[2402 to 2480MHz]	180±10.0°
Amplitude imbalance at balanced port	[2402 to 2480MHz]	0±2dB
Temperature range	Operating	-40 to +85°C
	Storage	-40 to +85°C

**FREQUENCY CHARACTERISTICS**

**SDS21 INSERTION LOSS**

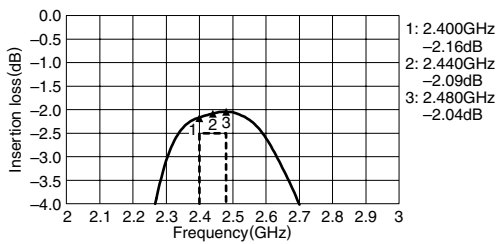

**SDS21 ATTENUATION**

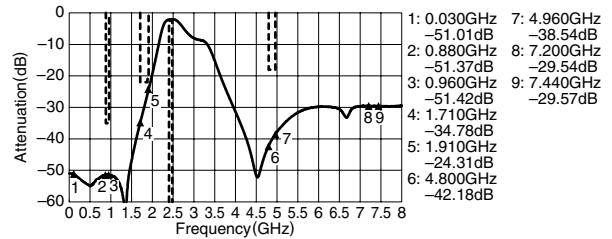

**AMPLITUDE IMBALANCE**

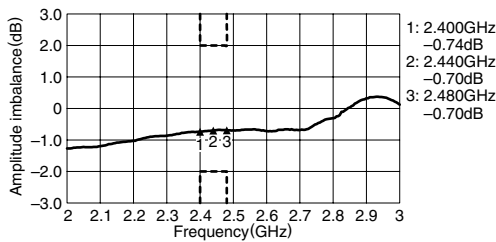

**PHASE IMBALANCE**

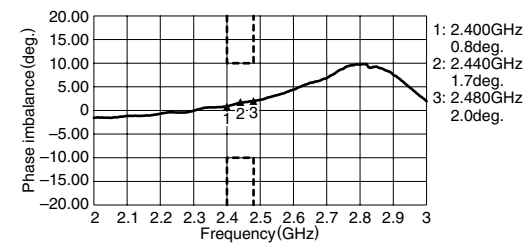

**SSS11 VSWR**

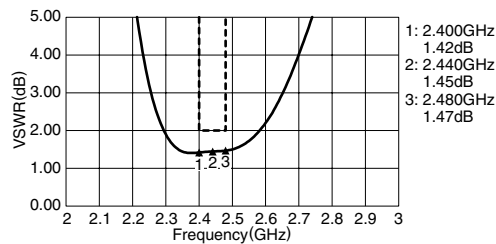

**SDD22 VSWR**

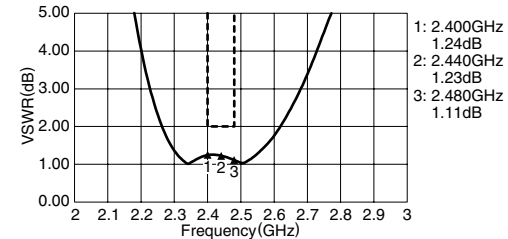

**SMITH CHARTS**

**SSS11**

**SDD22**

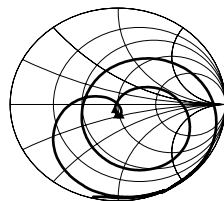
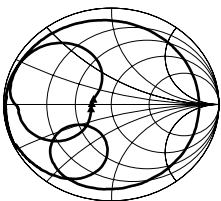

• All specifications are subject to change without notice.

**PACKAGING STYLES**  
**REEL DIMENSIONS**

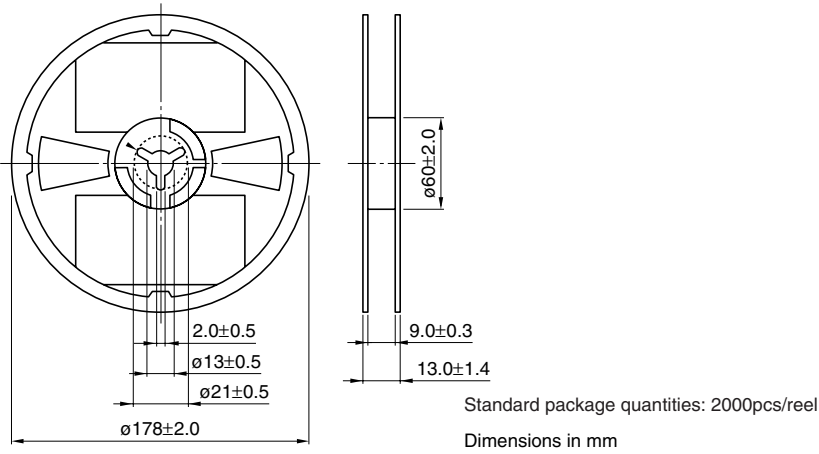

**TAPE DIMENSIONS**

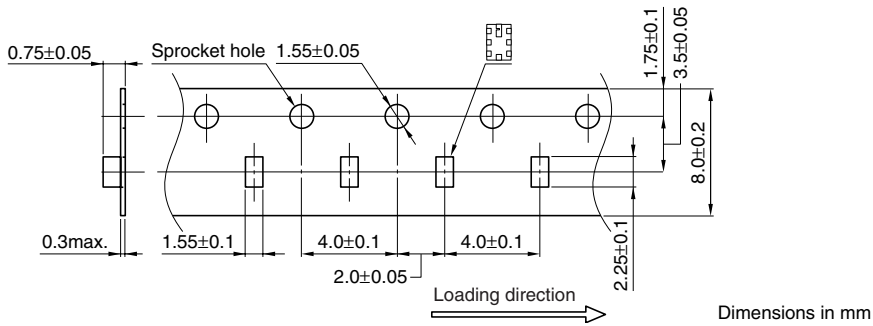

• All specifications are subject to change without notice.

# Multilayer Chip Band Pass Filters(Balance Output Type) Conformity to RoHS Directive

## For Bluetooth & 2.4GHz W-LAN

DEA Series DEA202450BT-7099A1

### FEATURES

- Miniature balanced band pass filter.
- Matched to  $24+j48.8\Omega$ .
- Package size:  $2.0 \times 1.25\text{mm}$ .
- Low profile : 0.8mm max. height.

### SHAPES AND DIMENSIONS

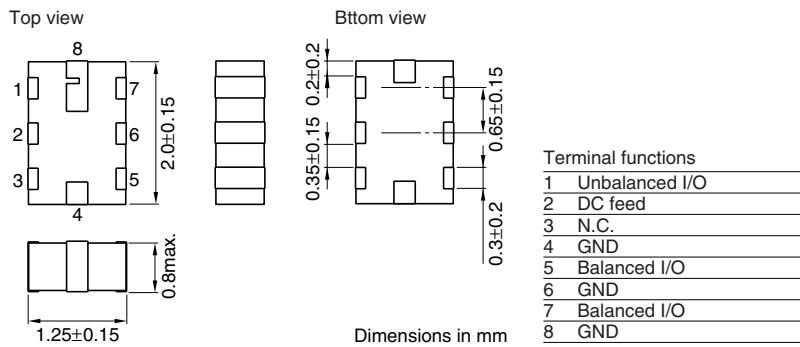

The identification marking in figure refer to prototype components only.  
A different component mark is used for mass production.

### RECOMMENDED PC BOARD PATTERNS

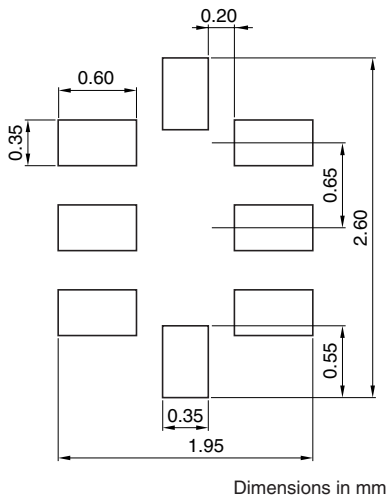

- Pin 2 of the filter provides a DC feed connection to the balanced ports.
- In the event that this function is used pin 2 should be connected to ground using a de-coupling capacitor.

• Conformity to RoHS Directive: This means that, in conformity with EU Directive 2002/95/EC, lead, cadmium, mercury, hexavalent chromium, and specific bromine-based flame retardants, PBB and PBDE, have not been used, except for exempted applications.

• All specifications are subject to change without notice.



### ELECTRICAL CHARACTERISTICS

Insertion Loss	[2402 to 2480MHz]	2.3dB typ.
Single ended port characteristic impedance	—	50Ω (Nominal)
Balanced ports impedance, nominal value	—	24 + j48.8Ω
Return loss: Unbalanced port	[2402 to 2480MHz]	11.9dB typ.
Return loss: Balanced port (with respect to nominal balanced impedance)		11dB typ.
Attenuation	[880 to 960MHz]	47dB typ.
	[1710 to 1880MHz]	29dB typ.
	[1880 to 1910MHz]	27dB typ.
	[2110 to 2170MHz]	10dB typ.
	[4804 to 4960MHz]	36dB typ.
Phase difference at balanced port	[2402 to 2480MHz]	176deg typ.
Amplitude imbalance at balanced port	[2402 to 2480MHz]	0.9dB typ.
Temperature range	Operating	-40 to +85°C
	Storage	-40 to +85°C

### FREQUENCY CHARACTERISTICS

#### INSERTION LOSS/ATTENUATION

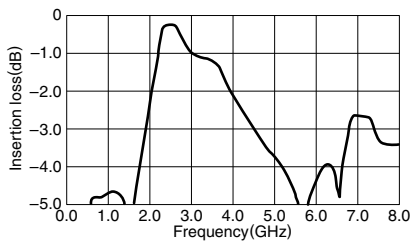

#### RETURN LOSS(Unbalance)

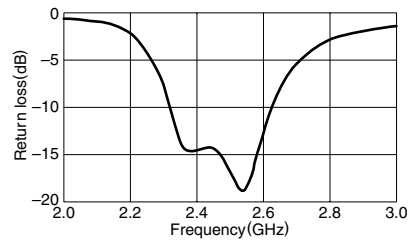

#### RETURN LOSS(Balance)

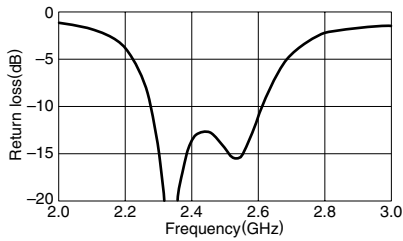

#### AMPLITUDE IMBALANCE

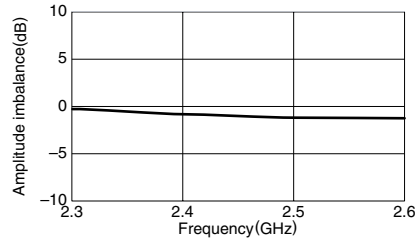

#### PHASE DIFFERENCE

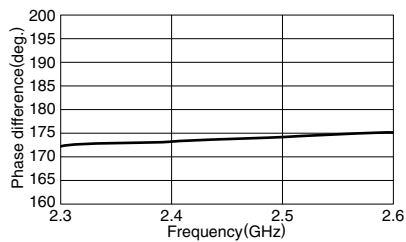

#### COMMON MODE

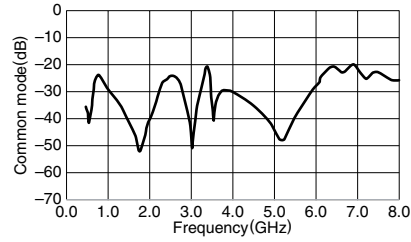

• All specifications are subject to change without notice.

# Multilayer Chip Band Pass Filters(Balance Output Type) Conformity to RoHS Directive

## For Bluetooth & 2.4GHz W-LAN

DEA Series DEA202450BT-7100C1

### SHAPES AND DIMENSIONS

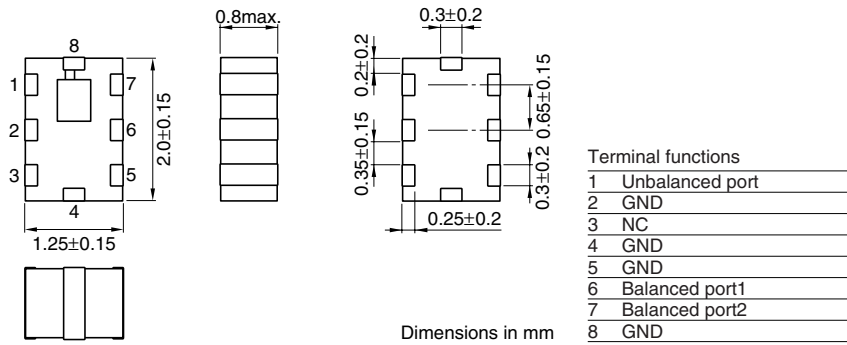

### RECOMMENDED PC BOARD PATTERN

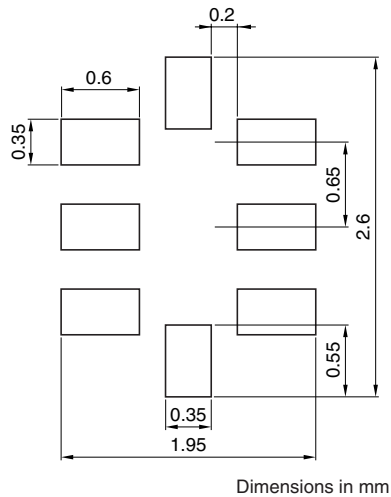

### EVALUATION BOARD

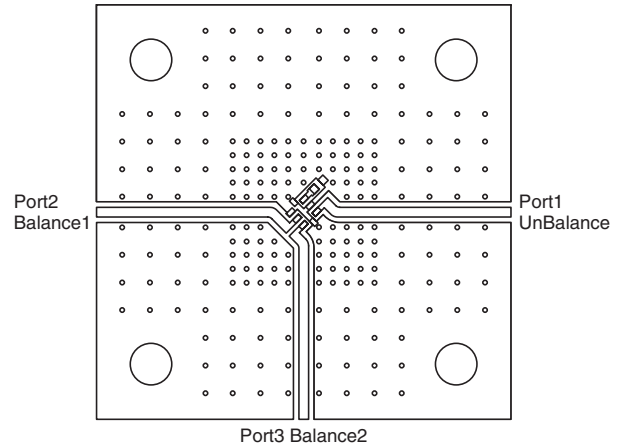

Port extension value  
 Port1 = 139.56p[sec]  
 Port2 = 143.16p[sec]  
 Port3 = 139.56p[sec]

- Conformity to RoHS Directive: This means that, in conformity with EU Directive 2002/95/EC, lead, cadmium, mercury, hexavalent chromium, and specific bromine-based flame retardants, PBB and PBDE, have not been used, except for exempted applications.

- All specifications are subject to change without notice.

### ELECTRICAL CHARACTERISTICS

Item		Minimum value	Typical value	Maximum value
Unbalanced port characteristics impedance	(Ω)	50[Nominal]		
Balanced port characteristics impedance	(Ω)	25+j30[Nominal]		
Differential mode insertion loss	[2402 to 2480MHz]	(dB)	—	3.5
	[65 to 108MHz]	(dB)	35	70
	[824 to 960MHz]	(dB)	35	46
Differential mode attenuation [100Ω reference]	[1570 to 1580MHz]	(dB)	30	43
	[1710 to 1990MHz]	(dB)	35	44
	[2010 to 2170MHz]	(dB)	23	31
	[7200 to 7500MHz]	(dB)	20	40
Common mode attenuation [25Ω reference]	[1570 to 1580MHz]	(dB)	30	34
	[1710 to 1990MHz]	(dB)	20	36
	[2010 to 2170MHz]	(dB)	20	33
	[4800 to 5000MHz]	(dB)	18	25
In/out return loss	(dB)	9	13	—
Phase difference at balanced port	(deg.)	180±10	174	—
Amplitude imbalance at balanced port	(dB)	0±2.8	1.7	—
Temperature range	Operating	(°C)	—	+85
	Storage	(°C)	-40	—

• Ta:+25°C

### FREQUENCY CHARACTERISTICS

Unbalance 50Ω/Balance 25+j30Ω

#### SDS21 INSERTION LOSS

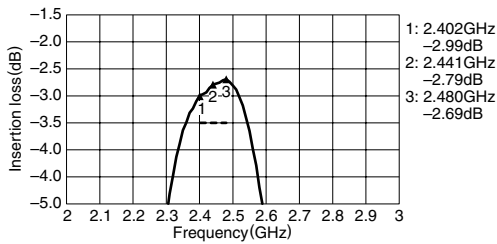

#### SDS21 ATTENUATION[100Ω REFERENCE]

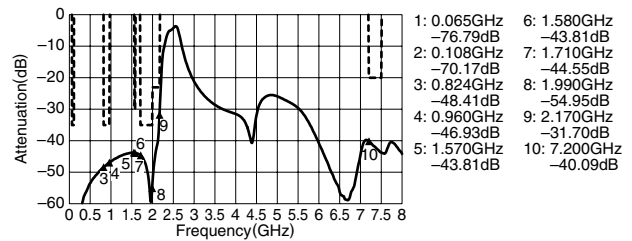

#### AMPLITUDE BALANCE

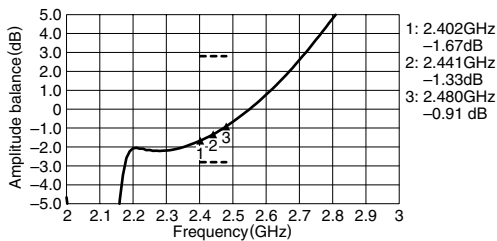

#### PHASE BALANCE

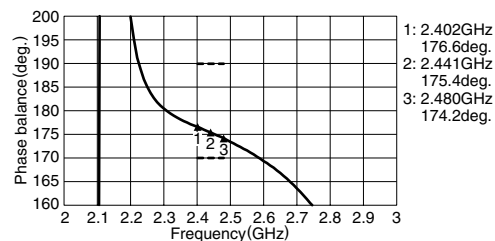

#### SSS11 UNBALANCE RETURN LOSS

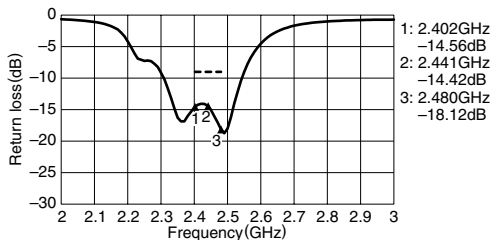

#### SDD22 BALANCE RETURN LOSS

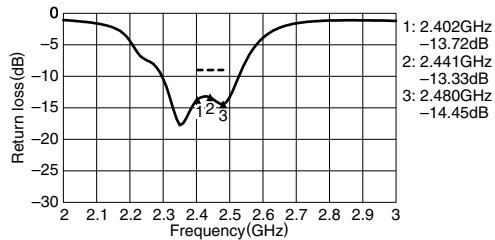

• All specifications are subject to change without notice.

### FREQUENCY CHARACTERISTICS

Unbalance 50Ω/Balance 25+j30Ω

#### SCS21 ATTENUATION[25Ω REFERENCE]

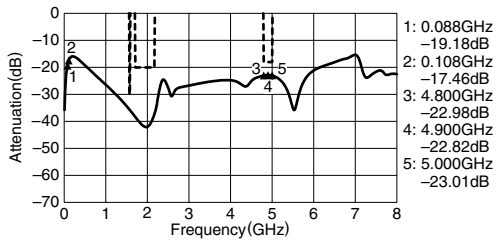

#### SCC22 ANGLE[25Ω REFERENCE]

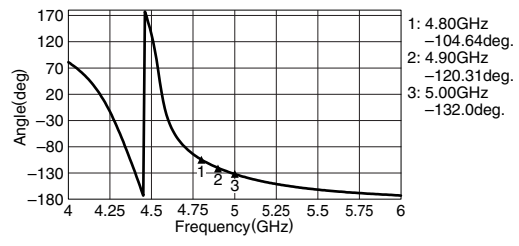

#### SCC22 MAGNITUDE[25Ω REFERENCE]

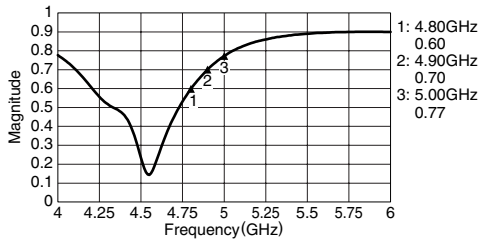

### SMITH CHARTS

S11

SDD22

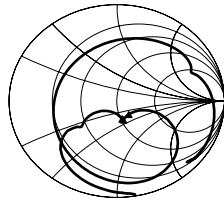
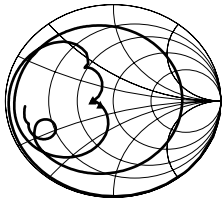

# Multilayer Chip Band Pass Filters(Balance Output Type) Conformity to RoHS Directive

## For Bluetooth & 2.4GHz W-LAN

DEA Series DEA202350BT-7196A1

### SHAPES AND DIMENSIONS

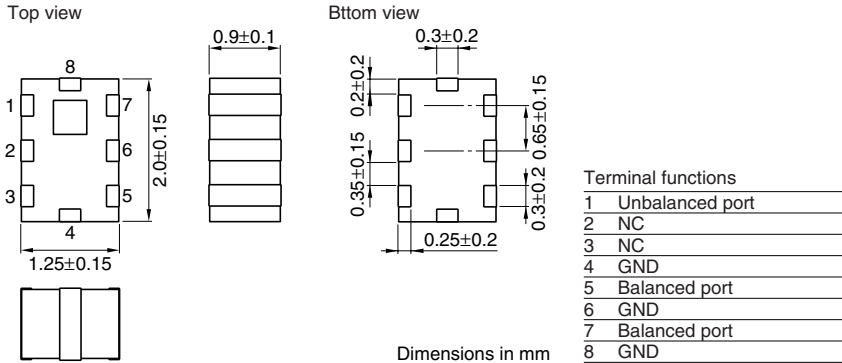

### RECOMMENDED PC BOARD PATTERNS

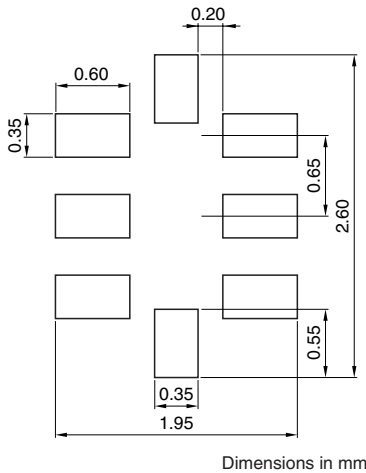

### EVALUATION BOARD

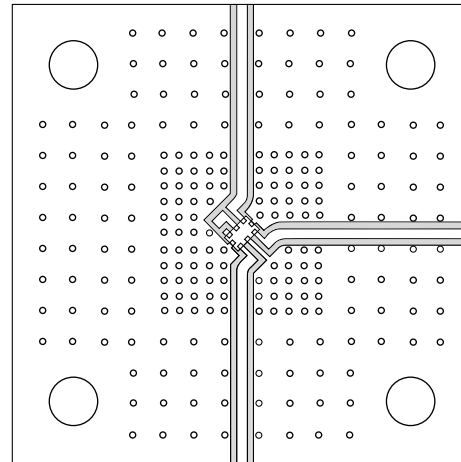

Port extension value is 139.56ps for all port.

### ELECTRICAL CHARACTERISTICS

Item	Typical value	
Frequency range(Pass band)	2300 to 2400MHz	
Insertion loss	[+25°C]	2.2dB max. 1.76dB
	[-40 to +85°C]	2.5dB max. —
Single ended port characteristic impedance	50Ω (Nominal) —	
Balanced port differential characteristics impedance	100dB —	
Attenuation	[500 to 1000MHz]	34dB min. 44.3dB
	[1000 to 1785MHz]	26dB min. 31.6dB
	[1785 to 1880MHz]	25dB min. 34.9dB
	[1880 to 1980MHz]	15dB min. 22.6dB
	[2720 to 5900MHz]	10dB min. 13.2dB
Single ended return loss	[2300 to 2400MHz]	— 17dB
Phase difference at balanced port	[2300 to 2400MHz]	— 185.1deg.
Amplitude imbalance at balanced port	[2300 to 2400MHz]	— 0.13dB
Temperature range	Operating	-40 to +85°C
	Storage	-40 to +85°C

• Ta:+25°C

• Conformity to RoHS Directive: This means that, in conformity with EU Directive 2002/95/EC, lead, cadmium, mercury, hexavalent chromium, and specific bromine-based flame retardants, PBB and PBDE, have not been used, except for exempted applications.

• All specifications are subject to change without notice.

### FREQUENCY CHARACTERISTICS

Unbalance 50Ω/Balance 100Ω

#### SDS21 INSERTION LOSS

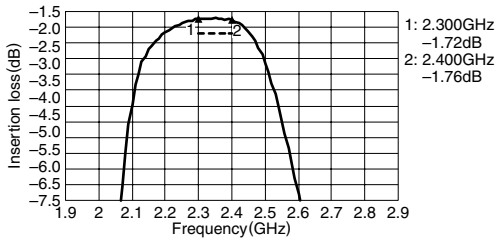

#### SDS21 ATTENUATION

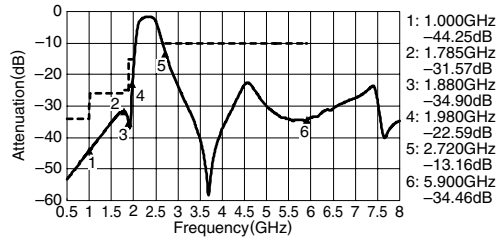

#### AMPLITUDE BALANCE

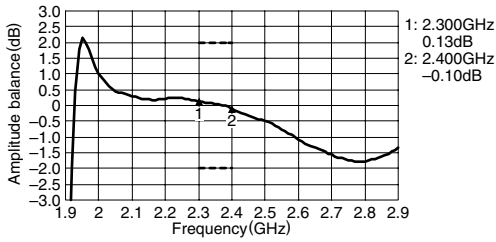

#### PHASE BALANCE

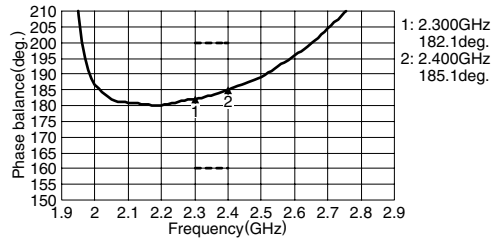

#### S11 UNBALANCE RETURN LOSS

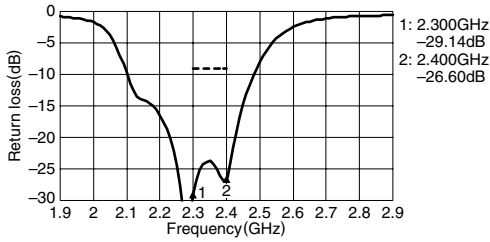

#### SDD22 BALANCE RETURN LOSS

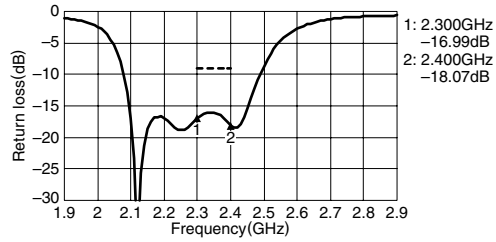

#### SCS21

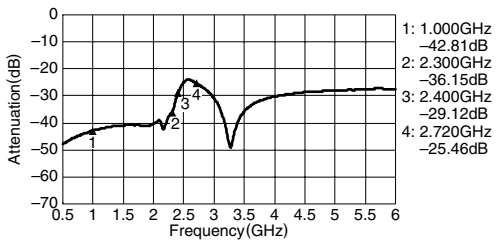

#### SMITH CHARTS

S11

SDD22

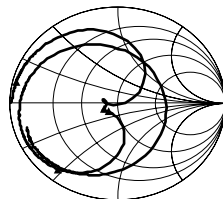
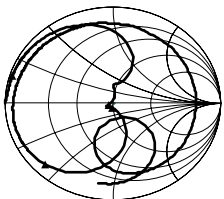

# Multilayer Chip Band Pass Filters(Balance Output Type) Conformity to RoHS Directive

## For Bluetooth & 2.4GHz W-LAN

DEA Series DEA202450BT-7077A1

### SHAPES AND DIMENSIONS

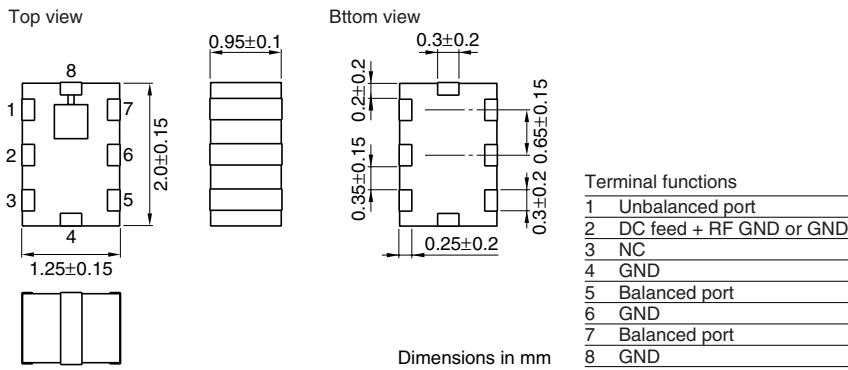

### RECOMMENDED PC BOARD PATTERN

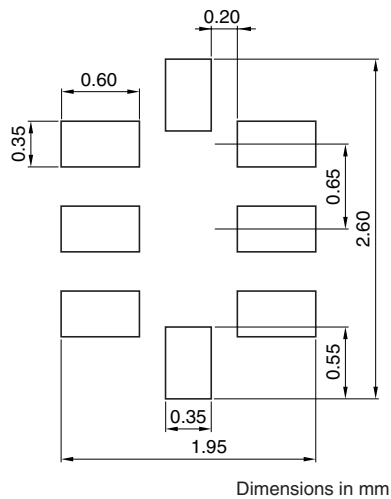

- Conformity to RoHS Directive: This means that, in conformity with EU Directive 2002/95/EC, lead, cadmium, mercury, hexavalent chromium, and specific bromine-based flame retardants, PBB and PBDE, have not been used, except for exempted applications.

- All specifications are subject to change without notice.

### ELECTRICAL CHARACTERISTICS

Frequency range(Pass band)		2400MHz	2500MHz
Insertion loss	[+25°C]	—	3.5dB max.
	[-40 to +85°C]	—	3.8dB max.
Single ended port characteristic impedance		50Ω (Nominal)	—
Balanced port differential characteristics impedance		34+j72Ω(Nominal)	—
Attenuation	[880 to 960MHz]	40dB	—
	[1710 to 1880MHz]	38dB	—
	[1880 to 1990MHz]	38dB	—
	[2110 to 2170MHz]	17dB	—
	[4800 to 5000MHz]	25dB	—
	[7200 to 7500MHz]	27dB	—
Single ended return loss	[2400 to 2500MHz]	9.0dB	—
Balanced return loss	[2400 to 2500MHz]	9.0dB	—
Phase difference at balanced port		170deg.	190deg.
Amplitude imbalance at balanced port		-1.0dB	1.0dB
Temperature range	Operating	-40 to +85°C	
	Storage	-40 to +85°C	

• Ta:+25°C

### FREQUENCY CHARACTERISTICS

Unbalance 50Ω/Balance 34+j72Ω

#### SDS21 INSERTION LOSS

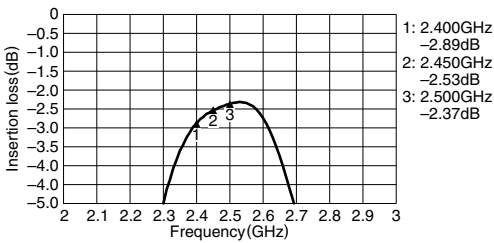

#### SDS21 ATTENUATION

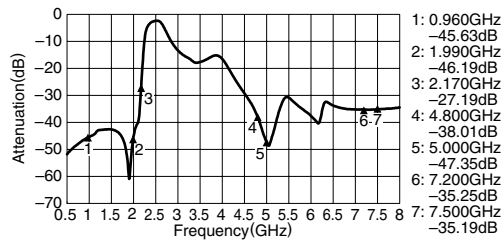

#### S11 UNBALANCE RETURN LOSS

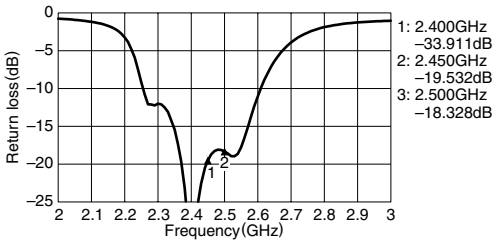

#### SDD22 BALANCE RETURN LOSS

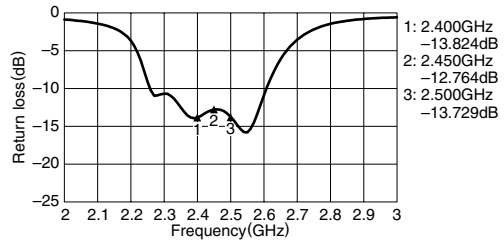

#### AMPLITUDE BALANCE

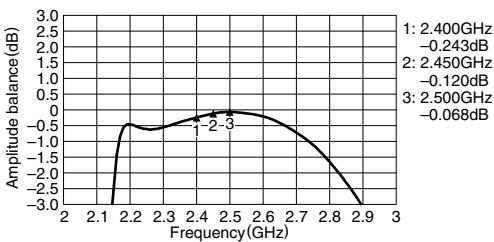

#### PHASE BALANCE

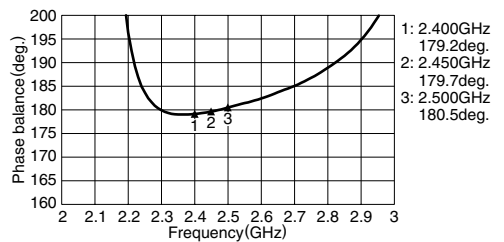

#### SCS21 CMRR

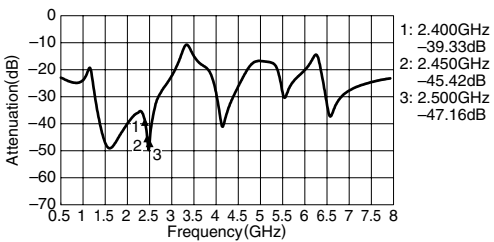

• All specifications are subject to change without notice.



**SMITH CHARTS**

**S11**

**SDD22**

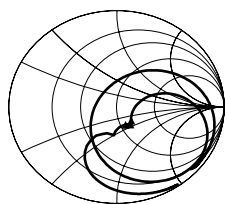
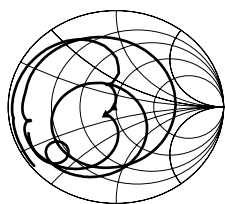

# Multilayer Chip Band Pass Filters(Balance Output Type) For Bluetooth & 2.4GHz W-LAN

Conformity to RoHS Directive

DEA Series DEA202450BT-7089C3

## SHAPES AND DIMENSIONS

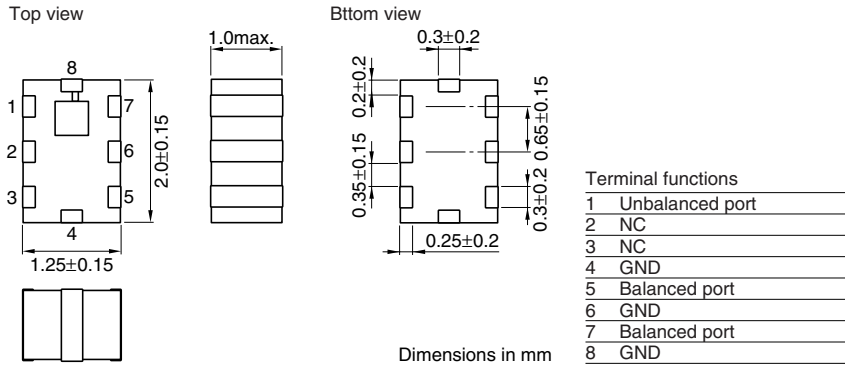

## RECOMMENDED PC BOARD PATTERNS

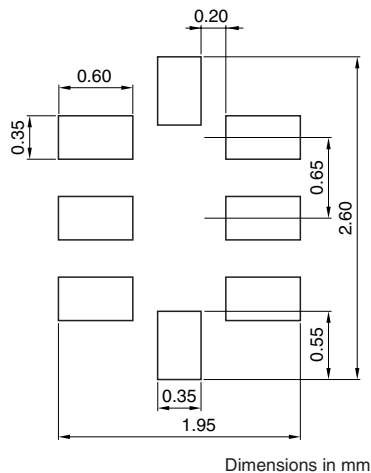

## ELECTRICAL CHARACTERISTICS

Item	Typical value		
Frequency range(Pass band)	2400 to 2500MHz		
Insertion loss	[+25°C]	3.4dB max.	
	[-40 to +85°C]	3.7dB max.	
Single ended port characteristic impedance	50Ω (Nominal)		
Balanced port differential characteristics impedance	55+j50Ω (Nominal)		
Attenuation	[10 to 915MHz]	40dB min.	46dB
	[925 to 960MHz]	39dB min.	45dB
	[1570 to 1580MHz]	30dB min.	44dB
	[1710 to 1785MHz]	39dB min.	47dB
	[1805 to 1880MHz]	25dB min.	55dB
	[1850 to 1910MHz]	38dB min.	51dB
	[1920 to 1990MHz]	33dB min.	48dB
	[2112 to 2168MHz]	20dB min.	31dB
	[4800 to 5000MHz]	26dB min.	38dB
Single ended return loss	[2400 to 2500MHz]	8.5dB min.	13dB
	[2400 to 2500MHz]	8.5dB min.	14dB
Phase difference at balanced port	[2400 to 2500MHz]	180±10deg.	183deg.
Amplitude imbalance at balanced port	[2400 to 2500MHz]	0±2.0dB	-0.5dB
Temperature range	Operating	-40 to +85°C	
	Storage	-40 to +85°C	

• Ta:+25°C

• Conformity to RoHS Directive: This means that, in conformity with EU Directive 2002/95/EC, lead, cadmium, mercury, hexavalent chromium, and specific bromine-based flame retardants, PBB and PBDE, have not been used, except for exempted applications.

• All specifications are subject to change without notice.

### FREQUENCY CHARACTERISTICS

Unbalance 50Ω/Balance 55+j50Ω

#### SDS21 INSERTION LOSS

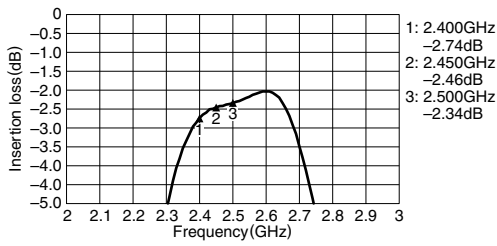

#### SDS21 ATTENUATION

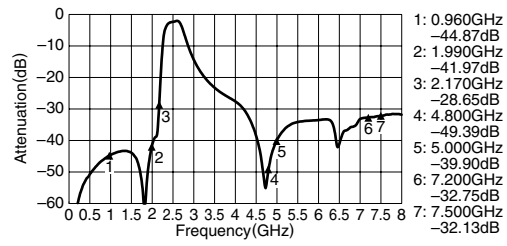

#### S11 UNBALANCE RETURN LOSS

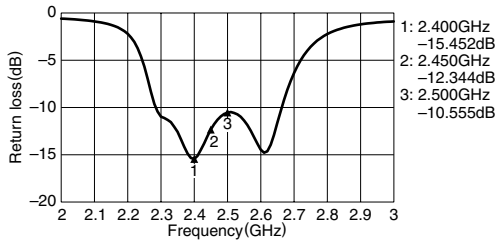

#### SDD22 BALANCE RETURN LOSS

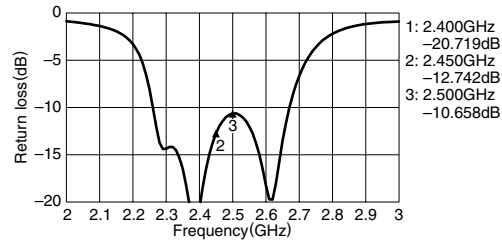

#### AMPLITUDE BALANCE

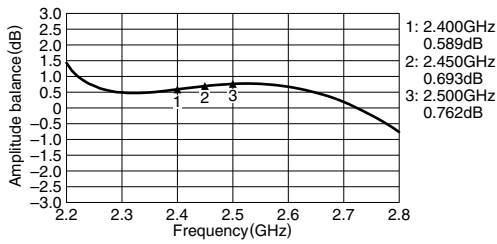

#### PHASE BALANCE

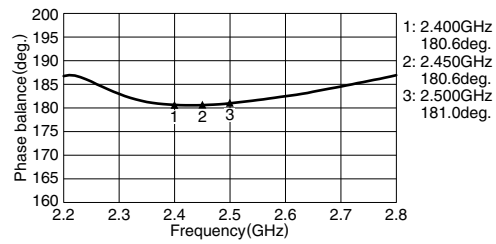

#### SCS21 CMRR

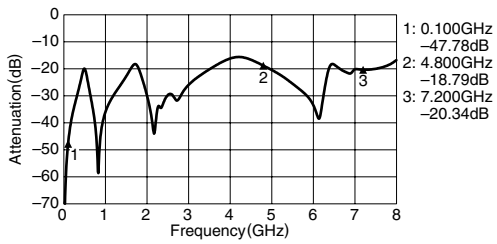

#### SMITH CHARTS

S11

SDD22

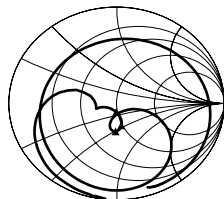
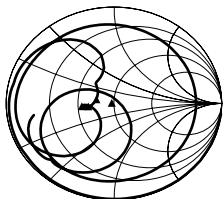

# Multilayer Chip Band Pass Filters(Balance Output Type) Conformity to RoHS Directive For Bluetooth & 2.4GHz W-LAN

DEA Series DEA202450BT-7112B1

## SHAPES AND DIMENSIONS

Top view

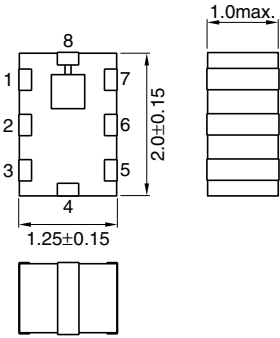

Bttom view

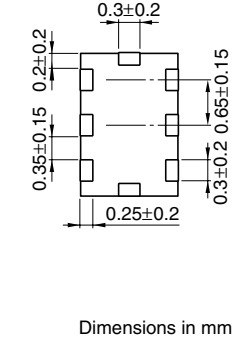

Terminal functions

1	Unbalanced port
2	NC
3	NC
4	GND
5	Balanced port
6	GND
7	Balanced port
8	GND

Dimensions in mm

## RECOMMENDED PC BOARD PATTERN

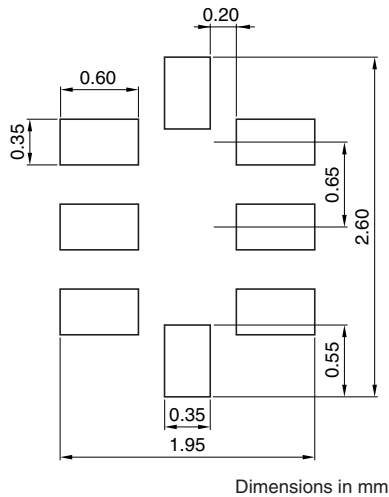

Dimensions in mm

## EVALUATION BOARD

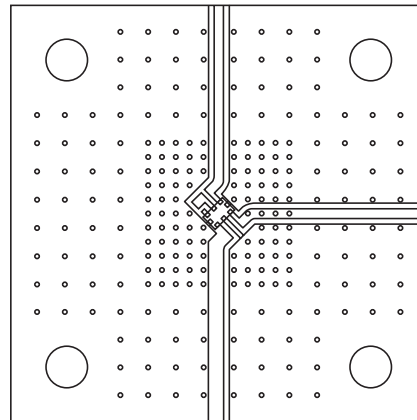

Port extension value is 139.56ps for all port.

• Conformity to RoHS Directive: This means that, in conformity with EU Directive 2002/95/EC, lead, cadmium, mercury, hexavalent chromium, and specific bromine-based flame retardants, PBB and PBDE, have not been used, except for exempted applications.

• All specifications are subject to change without notice.

### ELECTRICAL CHARACTERISTICS

Frequency range(Pass band)		2400MHz	2500MHz
Insertion loss	[+25°C]	—	2.5dB max.
	[-40 to +85°C]	—	2.8dB max.
Single ended port characteristic impedance		50Ω (Nominal)	—
Balanced port differential characteristics impedance		50+j40Ω (Nominal)	—
Attenuation	[10 to 915MHz]	41dB	—
	[925 to 960MHz]	34dB	—
	[1570 to 1580MHz]	30dB	—
	[1710 to 1785MHz]	40dB	—
	[1805 to 1880MHz]	26dB	—
	[1850 to 1910MHz]	40dB	—
	[1920 to 1990MHz]	31dB	—
Single ended return loss	[2400 to 2500MHz]	9dB	—
	[2400 to 2500MHz]	9dB	—
Phase difference at balanced port	[2400 to 2500MHz]	170deg.	190deg.
Amplitude imbalance at balanced port	[2400 to 2500MHz]	-2dB	2dB
Common mode attenuation	[88 to 108MHz]	15dB	—
	[4800 to 5000MHz]	18dB	—
Common mode impedance [4900MHz]	Magnitude	0.6	—
	Angle	-45deg.	12deg.
Temperature range	Operating	-40 to +85°C	—
	Storage	-40 to +85°C	—

• Ta:+25°C

### FREQUENCY CHARACTERISTICS

Unbalance 50Ω/Balance 50+j40Ω

#### SDS21 INSERTION LOSS

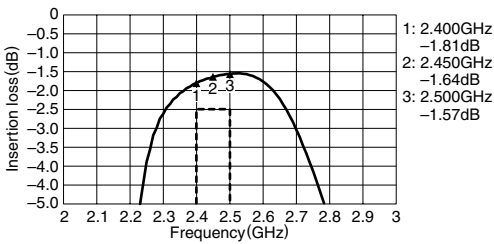

#### SDS21 ATTENUATION

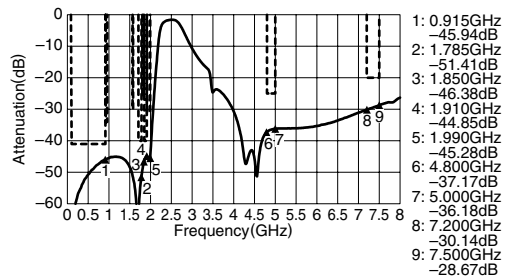

#### AMPLITUDE BALANCE

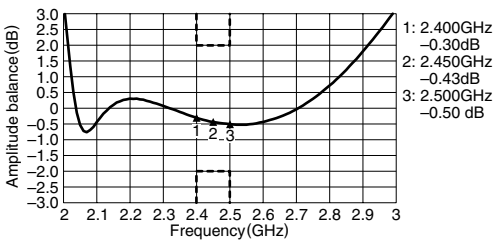

#### PHASE BALANCE

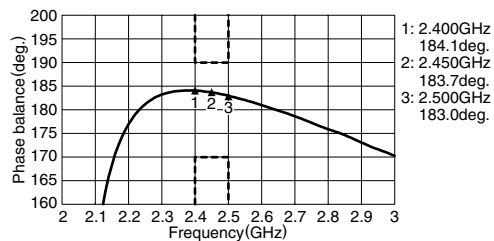

#### S11 UNBALANCE RETURN LOSS

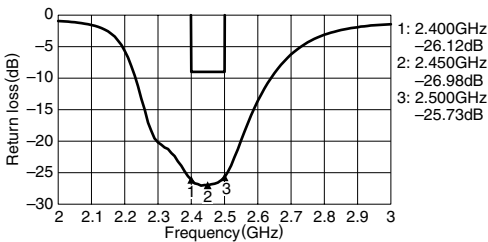

#### SDD22 BALANCE RETURN LOSS

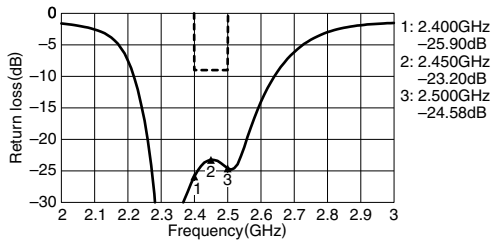

• All specifications are subject to change without notice.

### FREQUENCY CHARACTERISTICS

Unbalance 50Ω/Balance 50+j40Ω

SCS21

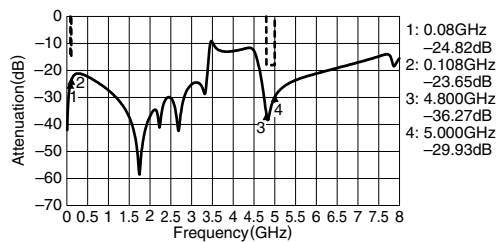

### SCC22 MAGNITUDE

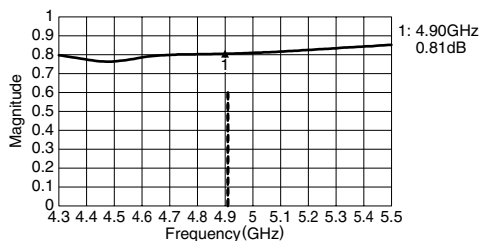

### SCC22 ANGLE

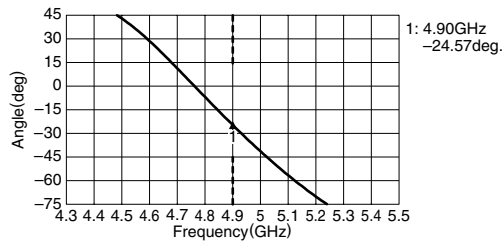

• All specifications are subject to change without notice.

# Multilayer Chip Band Pass Filters(Balance Output Type) Conformity to RoHS Directive For Bluetooth & 2.4GHz W-LAN

DEA Series DEA202450BT-7112E1

## SHAPES AND DIMENSIONS

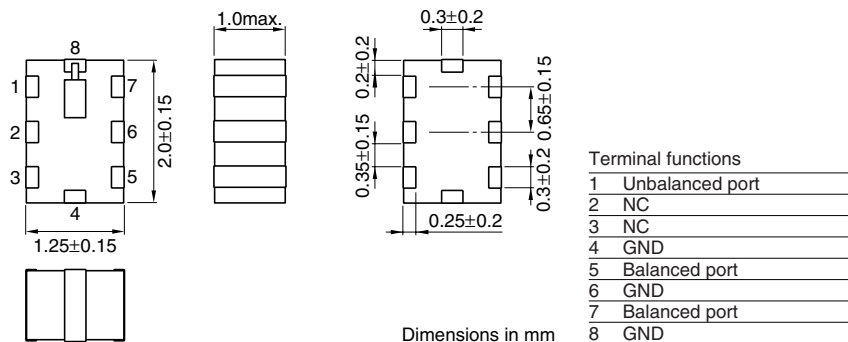

## RECOMMENDED PC BOARD PATTERN

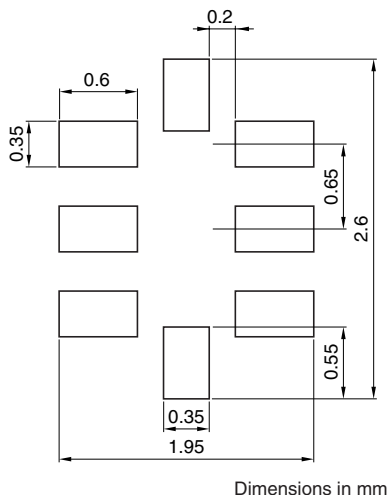

## EVALUATION BOARD

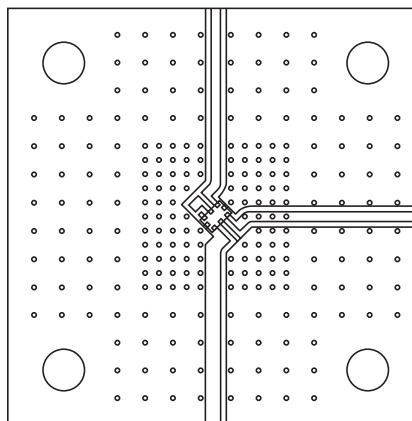

Port extension value is 139.56ps for all port.

• Conformity to RoHS Directive: This means that, in conformity with EU Directive 2002/95/EC, lead, cadmium, mercury, hexavalent chromium, and specific bromine-based flame retardants, PBB and PBDE, have not been used, except for exempted applications.

• All specifications are subject to change without notice.

## ELECTRICAL CHARACTERISTICS

Item		Minimum value	Typical value	Maximum value
Frequency range(Pass band)	(MHz)	2400	—	2500
Insertion loss	[+25°C]	—	—	2.5
	[-40 to +85°C]	—	—	2.8
Single ended port characteristic impedance	(Ω)	50[Nominal]		
Balanced port differential characteristics impedance	(Ω)	50+j40		
Attenuation	[10 to 915MHz]	(dB)	41	—
	[925 to 960MHz]	(dB)	34	—
	[1570 to 1580MHz]	(dB)	30	—
	[1710 to 1785MHz]	(dB)	40	—
	[1805 to 1880MHz]	(dB)	26	—
	[1850 to 1910MHz]	(dB)	40	—
	[1920 to 1990MHz]	(dB)	31	—
	[4800 to 5000MHz]	(dB)	25	—
Single ended return loss	[2400 to 2500MHz]	(dB)	9	—
Balanced return loss	[2400 to 2500MHz]	(dB)	9	—
Phase difference at balanced port	[2400 to 2500MHz]	(deg.)	170	—
Amplitude imbalance at balanced port	[2400 to 2500MHz]	(dB)	-2	2
Common mode attenuation	[88 to 108MHz]	(dB)	15	—
	[4800 to 5000MHz]	(dB)	18	—
Common mode impedance [4900MHz]	Magnitude		0.6	—
	Angle	(deg.)	15	75
Power capacity		(mW)	—	500
Temperature range	Operating	(°C)	-40	+85
	Storage	(°C)	-40	+85

• Ta:+25°C

## FREQUENCY CHARACTERISTICS

Unbalance 50Ω/Balance 50+j40Ω

### SDS21 INSERTION LOSS

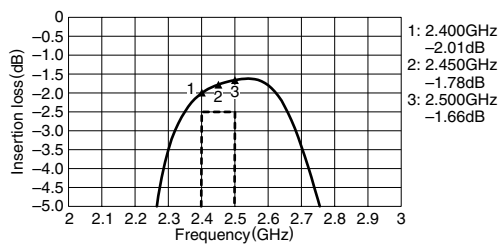

### SDS21 ATTENUATION

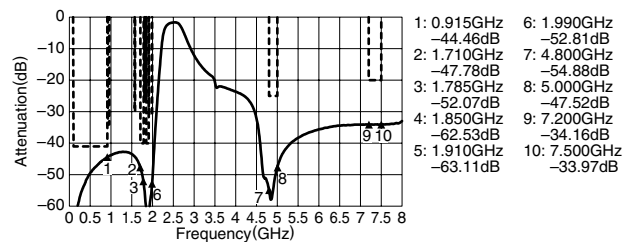

### AMPLITUDE BALANCE

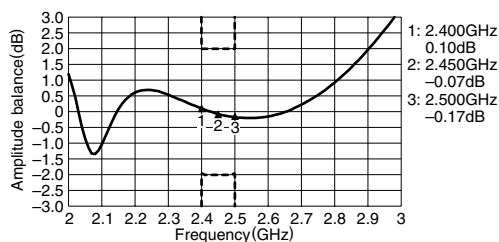

### PHASE BALANCE

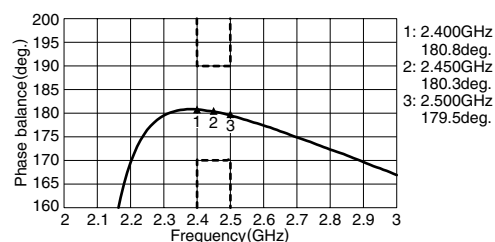

### S11 UNBALANCE RETURN LOSS

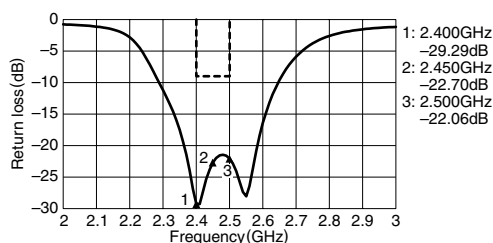

### SDD22 BALANCE RETURN LOSS

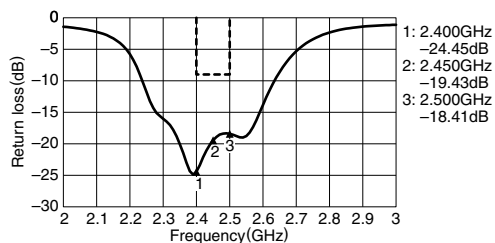

• All specifications are subject to change without notice.



### FREQUENCY CHARACTERISTICS

Unbalance 50Ω/Balance 50+j40Ω

#### SCS21 ATTENUATION

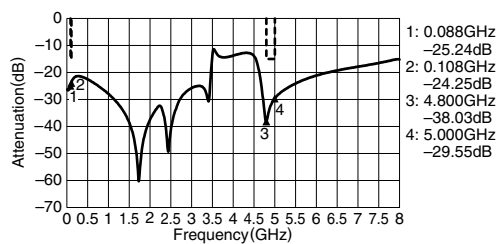

#### SCC22 ANGLE

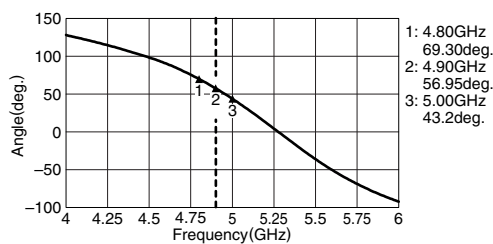

#### SCC22 MAGNITUDE

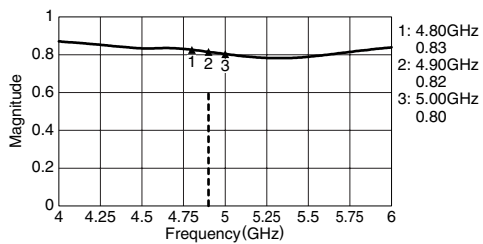

#### SMITH CHARTS

S11

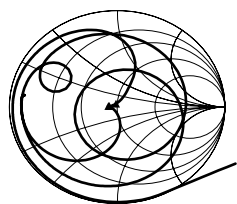

SDD22

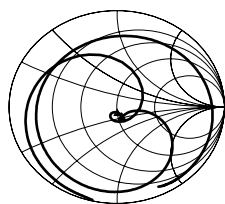



Компания «ЭлектроПласт» предлагает заключение долгосрочных отношений при поставках импортных электронных компонентов на взаимовыгодных условиях!

Наши преимущества:

- Оперативные поставки широкого спектра электронных компонентов отечественного и импортного производства напрямую от производителей и с крупнейших мировых складов;
- Поставка более 17-ти миллионов наименований электронных компонентов;
- Поставка сложных, дефицитных, либо снятых с производства позиций;
- Оперативные сроки поставки под заказ (от 5 рабочих дней);
- Экспресс доставка в любую точку России;
- Техническая поддержка проекта, помощь в подборе аналогов, поставка прототипов;
- Система менеджмента качества сертифицирована по Международному стандарту ISO 9001;
- Лицензия ФСБ на осуществление работ с использованием сведений, составляющих государственную тайну;
- Поставка специализированных компонентов (Xilinx, Altera, Analog Devices, Intersil, Interpoint, Microsemi, Aeroflex, Peregrine, Syfer, Eurofarad, Texas Instrument, Miteq, Cobham, E2V, MA-COM, Hittite, Mini-Circuits, General Dynamics и др.);

Помимо этого, одним из направлений компании «ЭлектроПласт» является направление «Источники питания». Мы предлагаем Вам помощь Конструкторского отдела:

- Подбор оптимального решения, техническое обоснование при выборе компонента;
- Подбор аналогов;
- Консультации по применению компонента;
- Поставка образцов и прототипов;
- Техническая поддержка проекта;
- Защита от снятия компонента с производства.



#### Как с нами связаться

**Телефон:** 8 (812) 309 58 32 (многоканальный)

**Факс:** 8 (812) 320-02-42

**Электронная почта:** [org@eplast1.ru](mailto:org@eplast1.ru)

**Адрес:** 198099, г. Санкт-Петербург, ул. Калинина, дом 2, корпус 4, литера А.