



# Low Power, 3.6 MHz, Low Noise, Rail-to-Rail Output, Operational Amplifiers

## ADA4691-2/ADA4691-4/ADA4692-2/ADA4692-4

### FEATURES

- Low power: 180  $\mu$ A typical**
- Very low input bias currents: 0.5 pA typical**
- Low noise: 16 nV/ $\sqrt{\text{Hz}}$  typical**
- 3.6 MHz bandwidth**
- Offset voltage: 500  $\mu$ V typical**
- Low offset voltage drift: 4  $\mu$ V/ $^{\circ}$ C maximum**
- Low distortion: 0.003% THD + N**
- 2.7 V to 5 V single supply or  $\pm 1.35$  V to  $\pm 2.5$  V dual supply**
- Available in very small 2 mm  $\times$  2 mm LFCSP packages**

### APPLICATIONS

- Photodiode amplifiers**
- Sensor amplifiers**
- Portable medical and instrumentation**
- Portable audio: MP3s, PDAs, and smartphones**
- Communications**
- Low-side current sense**
- ADC drivers**
- Active filters**
- Sample-and-hold**

### GENERAL DESCRIPTION

The ADA4691-2/ADA4692-2 are dual and the ADA4691-4/ADA4692-4 are the quad rail-to-rail output, single-supply amplifiers featuring low power, wide bandwidth, and low noise. The ADA4691-2 has two independent shutdown pins, allowing further reduction in supply current. The ADA4691-4 is a quad with dual shutdown pins each controlling a pair of amplifiers and is available in the 16-lead LFCSP. The ADA4692-4 is a quad version without shutdown.

These amplifiers are ideal for a wide variety of applications. Audio, filters, photodiode amplifiers, and charge amplifiers, all benefit from this combination of performance and features. Additional applications for these amplifiers include portable consumer audio players with low noise and low distortion that provide high gain and slew rate response over the audio band at low power. Industrial applications with high impedance sensors, such as piezoelectric and IR sensors, benefit from the high impedance and low 0.5 pA input bias, low offset drift, and enough bandwidth and response for low gain applications.

The ADA4691/ADA4692 family is fully specified over the extended industrial temperature range ( $-40^{\circ}\text{C}$  to  $+125^{\circ}\text{C}$ ). The ADA4691-2 is available in a 10-lead LFCSP and a 9-ball WLCSP. The ADA4692-2 is available in an 8-lead SOIC and 8-lead LFCSP. The ADA4691-4 is available in a 16-lead LFCSP. The ADA4692-4 is available in a 14-lead TSSOP. For pin configurations, see the [Pin Configurations](#) section.

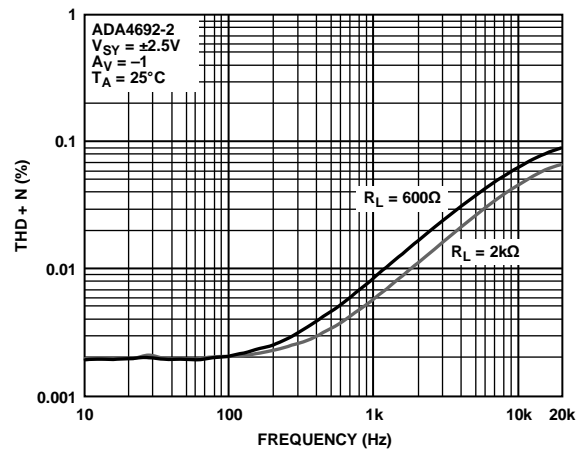

Figure 1. THD + Noise vs. Frequency

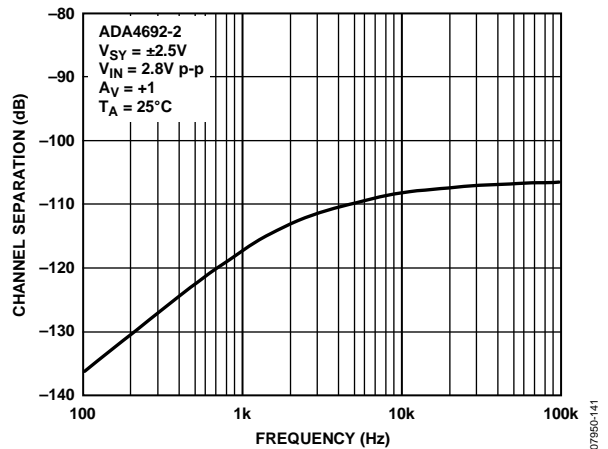

Figure 2. Channel Separation vs. Frequency

Table 1.

	Micropower	Low Power	Low Power with Shutdown	Standard Op Amp With Shutdown	High Bandwidth
Single	<a href="#">AD8613</a>			<a href="#">AD8591</a>	<a href="#">AD8691</a>
Dual	<a href="#">AD8617</a>	<a href="#">ADA4692-2</a>	<a href="#">ADA4691-2</a>	<a href="#">AD8592</a>	<a href="#">AD8692</a>
Quad	<a href="#">AD8619</a>	<a href="#">ADA4692-4</a>	<a href="#">ADA4691-4</a>	<a href="#">AD8594</a>	<a href="#">AD8694</a>

### Rev. C

Information furnished by Analog Devices is believed to be accurate and reliable. However, no responsibility is assumed by Analog Devices for its use, nor for any infringements of patents or other rights of third parties that may result from its use. Specifications subject to change without notice. No license is granted by implication or otherwise under any patent or patent rights of Analog Devices. Trademarks and registered trademarks are the property of their respective owners.

**TABLE OF CONTENTS**

Features .....	1	ESD Caution.....	6
Applications.....	1	Pin Configurations.....	7
General Description .....	1	Typical Performance Characteristics .....	8
Revision History .....	2	Shutdown Operation.....	16
Specifications.....	3	Input Pin Characteristics.....	16
Electrical Characteristics—2.7 V Operation .....	3	Input Threshold.....	16
Electrical Characteristics—5 V Operation.....	4	Outline Dimensions .....	17
Absolute Maximum Ratings.....	6	Ordering Guide .....	20
Thermal Resistance .....	6		

**REVISION HISTORY**

**12/09—Rev. B to Rev. C**

Added ADA4691-4, 16-Lead LFCSP .....	Throughout
Added Figure 1, Figure 2, and Table 1; Renumbered Sequentially .....	1
Changes to Applications Section and General Description Section.....	1
Changes to Table 1.....	3
Changes to Table 2.....	4
Changes to Table 4.....	6
Updated Outline Dimensions .....	17
Changes to Ordering Guide .....	20

**9/09—Rev. A to Rev. B**

Added ADA4691-2, 9-Ball WLCSP; ADA4692-2, 8-Lead LFCSP; and ADA4692-4, 14-Lead TSSOP .....	Throughout
Changes to General Description .....	1
Updated Outline Dimensions .....	16
Changes to Ordering Guide .....	17

**6/09—Rev. 0 to Rev. A**

Added ADA4691-2, 10 Lead LFCSP .....	Throughout
Changes to Table 1.....	3
Changes to Table 2.....	4
Changes to Captions for Figure 40, Figure 41, Figure 43, and Figure 44 .....	13
Added Shutdown Operations Section .....	15
Updated Outline Dimensions .....	16
Changes to Ordering Guide .....	16

**3/09—Revision 0: Initial Version**

## SPECIFICATIONS

### ELECTRICAL CHARACTERISTICS—2.7 V OPERATION

$V_{SY} = 2.7\text{ V}$ ,  $V_{CM} = V_{SY}/2$ ,  $T_A = 25^\circ\text{C}$ , unless otherwise specified.

Table 2.

Parameter	Symbol	Test Conditions/Comments	Min	Typ	Max	Unit
<b>INPUT CHARACTERISTICS</b>						
Offset Voltage	$V_{OS}$	$V_{CM} = -0.3\text{ V to }+1.6\text{ V}$		0.5	2.5	mV
Dual (ADA469x-2)		$V_{CM} = -0.1\text{ V to }+1.6\text{ V}; -40^\circ\text{C} < T_A < +125^\circ\text{C}$			3.5	mV
Quad (ADA469x-4)		$V_{CM} = -0.1\text{ V to }+1.6\text{ V}; -40^\circ\text{C} < T_A < +125^\circ\text{C}$			4.0	mV
Offset Voltage Drift	$\Delta V_{OS}/\Delta T$	$-40^\circ\text{C} < T_A < +125^\circ\text{C}$		1	4	$\mu\text{V}/^\circ\text{C}$
Input Bias Current	$I_B$	$-40^\circ\text{C} < T_A < +125^\circ\text{C}$		0.5	5	pA
Input Offset Current	$I_{OS}$	$-40^\circ\text{C} < T_A < +125^\circ\text{C}$		1	8	pA
Input Voltage Range		$-40^\circ\text{C} < T_A < +125^\circ\text{C}$	-0.3		+1.6	V
Common-Mode Rejection Ratio	CMRR	$V_{CM} = -0.3\text{ V to }+1.6\text{ V}$	70	90		dB
Large Signal Voltage Gain	$A_{VO}$	$V_{CM} = -0.1\text{ V to }+1.6\text{ V}; -40^\circ\text{C} < T_A < +125^\circ\text{C}$	62			dB
		$R_L = 2\text{ k}\Omega, V_{OUT} = 0.5\text{ V to }2.2\text{ V}$	90	100		dB
		$-40^\circ\text{C} < T_A < +85^\circ\text{C}$	80			dB
		$-40^\circ\text{C} < T_A < +125^\circ\text{C}$	63			dB
		$R_L = 600\ \Omega, V_{OUT} = 0.5\text{ V to }2.2\text{ V}$	85	95		dB
Input Capacitance	$C_{IN}$					
Differential Mode	$C_{INDM}$			2.5		pF
Common Mode	$C_{INCM}$			7		pF
Logic High Voltage (Enabled)	$V_{IH}$	$-40^\circ\text{C} < T_A < +125^\circ\text{C}$	1.6			V
Logic Low Voltage (Power-Down)	$V_{IL}$	$-40^\circ\text{C} < T_A < +125^\circ\text{C}$			0.5	V
Logic Input Current (Per Pin)	$I_{IN}$	$-40^\circ\text{C} < T_A < +125^\circ\text{C}, 0\text{ V} \leq V_{SD} \leq 2.7\text{ V}$			1	$\mu\text{A}$
<b>OUTPUT CHARACTERISTICS</b>						
Output Voltage High	$V_{OH}$	$R_L = 2\text{ k}\Omega\text{ to GND}$	2.65	2.67		V
		$-40^\circ\text{C} < T_A < +125^\circ\text{C}$	2.6			V
		$R_L = 600\ \Omega\text{ to GND}$	2.55	2.59		V
		$-40^\circ\text{C} < T_A < +125^\circ\text{C}$	2.5			V
Output Voltage Low	$V_{OL}$	$R_L = 2\text{ k}\Omega\text{ to }V_{SY}$		24	30	mV
		$-40^\circ\text{C} < T_A < +125^\circ\text{C}$			40	mV
		$R_L = 600\ \Omega\text{ to }V_{SY}$		78	95	mV
		$-40^\circ\text{C} < T_A < +125^\circ\text{C}$			130	mV
Short-Circuit Current	$I_{SC}$	$V_{OUT} = V_{SY}\text{ or GND}$		$\pm 15$		mA
Closed-Loop Output Impedance	$Z_{OUT}$	$f = 1\text{ MHz}, A_V = -100$		372		$\Omega$
Output Pin Leakage Current		$-40^\circ\text{C} < T_A < +125^\circ\text{C}, \text{ shutdown active}, V_{SD} = V_{SS}$		10		nA
<b>POWER SUPPLY</b>						
Power Supply Rejection Ratio	PSRR	$V_S = 2.7\text{ V to }5.5\text{ V}$	80	90		dB
		$-40^\circ\text{C} < T_A < +125^\circ\text{C}$	75			dB
Supply Current Per Amplifier	$I_{SY}$	$V_{OUT} = V_{SY}/2$		165	200	$\mu\text{A}$
		$-40^\circ\text{C} < T_A < +125^\circ\text{C}$			240	$\mu\text{A}$
Supply Current Shutdown Mode	$I_{SD}$	All amplifiers shut down, $V_{SD} = V_{SS}$		10		nA
		$-40^\circ\text{C} < T_A < +125^\circ\text{C}$			2	$\mu\text{A}$

# ADA4691-2/ADA4691-4/ADA4692-2/ADA4692-4

Parameter	Symbol	Test Conditions/Comments	Min	Typ	Max	Unit
<b>DYNAMIC PERFORMANCE</b>						
Slew Rate	SR	$R_L = 600 \Omega$ , $C_L = 20 \text{ pF}$ , $A_V = +1$		1.1		V/ $\mu\text{s}$
		$R_L = 2 \text{ k}\Omega$ , $C_L = 20 \text{ pF}$ , $A_V = +1$		1.4		V/ $\mu\text{s}$
Settling Time to 0.1%	$t_s$	Step = 0.5 V, $R_L = 2 \text{ k}\Omega$ , 600 $\Omega$		1		$\mu\text{s}$
Gain Bandwidth Product	GBP	$R_L = 1 \text{ M}\Omega$ , $C_L = 35 \text{ pF}$ , $A_V = +1$		3.6		MHz
Phase Margin	$\Phi_M$	$R_L = 1 \text{ M}\Omega$ , $C_L = 35 \text{ pF}$ , $A_V = +1$		49		Degrees
Turn-On/Turn-Off Time		$R_L = 600 \Omega$		1		$\mu\text{s}$
<b>NOISE PERFORMANCE</b>						
Distortion	THD + N	$A_V = -1$ , $R_L = 2 \text{ k}\Omega$ , $f = 1 \text{ kHz}$ , $V_{IN \text{ rms}} = 0.15 \text{ V rms}$		0.009		%
		$A_V = -1$ , $R_L = 600 \Omega$ , $f = 1 \text{ kHz}$ , $V_{IN \text{ rms}} = 0.15 \text{ V rms}$		0.01		%
		$A_V = +1$ , $R_L = 2 \text{ k}\Omega$ , $f = 1 \text{ kHz}$ , $V_{IN \text{ rms}} = 0.15 \text{ V rms}$		0.006		%
		$A_V = +1$ , $R_L = 600 \Omega$ , $f = 1 \text{ kHz}$ , $V_{IN \text{ rms}} = 0.15 \text{ V rms}$		0.009		%
Voltage Noise	$e_n \text{ p-p}$	$f = 0.1 \text{ Hz to } 10 \text{ Hz}$		3.1		$\mu\text{V p-p}$
Voltage Noise Density	$e_n$	$f = 1 \text{ kHz}$		16		nV/ $\sqrt{\text{Hz}}$
		$f = 10 \text{ kHz}$		13		nV/ $\sqrt{\text{Hz}}$

## ELECTRICAL CHARACTERISTICS—5 V OPERATION

$V_{SY} = 5 \text{ V}$ ,  $V_{CM} = V_{SY}/2$ ,  $T_A = 25^\circ\text{C}$ , unless otherwise specified.

Table 3.

Parameter	Symbol	Test Conditions/Comments	Min	Typ	Max	Unit
<b>INPUT CHARACTERISTICS</b>						
Offset Voltage	$V_{OS}$	$V_{CM} = -0.3 \text{ V to } +3.9 \text{ V}$		0.5	2.5	mV
		$V_{CM} = -0.1 \text{ V to } +3.9 \text{ V}$ ; $-40^\circ\text{C} < T_A < +125^\circ\text{C}$			3.5	mV
		$V_{CM} = -0.1 \text{ V to } +3.9 \text{ V}$ ; $-40^\circ\text{C} < T_A < +125^\circ\text{C}$				4.0
Offset Voltage Drift	$\Delta V_{OS}/\Delta T$	$-40^\circ\text{C} < T_A < +125^\circ\text{C}$		1	4	$\mu\text{V}/^\circ\text{C}$
Input Bias Current	$I_B$	$-40^\circ\text{C} < T_A < +125^\circ\text{C}$		0.5	5	pA
					360	pA
Input Offset Current	$I_{OS}$	$-40^\circ\text{C} < T_A < +125^\circ\text{C}$		1	8	pA
					260	pA
Input Voltage Range		$-40^\circ\text{C} < T_A < +125^\circ\text{C}$	-0.3		+3.9	V
Common-Mode Rejection Ratio	CMRR	$V_{CM} = -0.3 \text{ V to } +3.9 \text{ V}$	75	98		dB
		$V_{CM} = -0.1 \text{ V to } +3.9 \text{ V}$ ; $-40^\circ\text{C} < T_A < +125^\circ\text{C}$	68			dB
Large Signal Voltage Gain	$A_{VO}$	$R_L = 2 \text{ k}\Omega$ , $V_O = 0.5 \text{ V to } 4.5 \text{ V}$ , $V_{CM} = 0 \text{ V}$	95	110		dB
		$-40^\circ\text{C} < T_A < +85^\circ\text{C}$	80			dB
		$-40^\circ\text{C} < T_A < +125^\circ\text{C}$	70			dB
		$R_L = 600 \Omega$ , $V_O = 0.5 \text{ V to } 4.5 \text{ V}$ , $V_{CM} = 0 \text{ V}$	90	100		dB
Input Capacitance	$C_{INDM}$			2.5		pF
				7		pF
Logic High Voltage (Enabled)	$V_{IH}$	$-40^\circ\text{C} < T_A < +125^\circ\text{C}$	2.0			V
Logic Low Voltage (Power-Down)	$V_{IL}$	$-40^\circ\text{C} < T_A < +125^\circ\text{C}$			0.8	V
Logic Input Current (Per Pin)	$I_{IN}$	$-40^\circ\text{C} < T_A < +125^\circ\text{C}$ , $0 \text{ V} \leq V_{SD} \leq 2.7 \text{ V}$			1	$\mu\text{A}$

# ADA4691-2/ADA4691-4/ADA4692-2/ADA4692-4

Parameter	Symbol	Test Conditions/Comments	Min	Typ	Max	Unit
<b>OUTPUT CHARACTERISTICS</b>						
Output Voltage High	V <sub>OH</sub>	R <sub>L</sub> = 2 kΩ	4.95	4.97		V
		-40°C ≤ T <sub>A</sub> ≤ +125°C	4.90			V
Output Voltage Low	V <sub>OL</sub>	R <sub>L</sub> = 600 Ω to GND	4.85	4.88		V
		-40°C ≤ T <sub>A</sub> ≤ +125°C	4.80			V
		R <sub>L</sub> = 2 kΩ		30	35	mV
		-40°C ≤ T <sub>A</sub> ≤ +125°C			50	mV
Short-Circuit Limit	I <sub>SC</sub>	R <sub>L</sub> = 600 Ω		100	110	mV
		-40°C ≤ T <sub>A</sub> ≤ +125°C			155	mV
Short-Circuit Limit	I <sub>SC</sub>	V <sub>OUT</sub> = V <sub>SY</sub> or GND		±55		mA
Closed-Loop Output Impedance	Z <sub>OUT</sub>	ADA4691-2, f = 1 MHz, A <sub>V</sub> = -100		364		Ω
		ADA4691-2, f = 1 MHz, A <sub>V</sub> = -100		246		Ω
Output Pin Leakage Current		-40°C < T <sub>A</sub> < +125°C, shutdown active, V <sub>SD</sub> = V <sub>SS</sub>		10		nA
<b>POWER SUPPLY</b>						
Power Supply Rejection Ratio	PSRR	V <sub>SY</sub> = 2.7 V to 5.5 V	80	90		dB
		-40°C ≤ T <sub>A</sub> ≤ +125°C	75			dB
Supply Current Per Amplifier	I <sub>SY</sub>	V <sub>OUT</sub> = V <sub>SY</sub> /2		180	225	μA
Supply Current Shutdown Mode	I <sub>SD</sub>	-40°C ≤ T <sub>A</sub> ≤ +125°C			275	μA
		All amplifiers shut down, V <sub>SD</sub> = V <sub>SS</sub>		10		nA
		-40°C ≤ T <sub>A</sub> ≤ +125°C			2	μA
<b>DYNAMIC PERFORMANCE</b>						
Slew Rate	SR	R <sub>L</sub> = 2 kΩ, 600 Ω, C <sub>L</sub> = 20 pF, A <sub>V</sub> = +1		1.3		V/μs
Settling Time to 0.1%	t <sub>s</sub>	V <sub>IN</sub> = 2 V step, R <sub>L</sub> = 2 kΩ or 600 Ω		1.5		μs
Gain Bandwidth Product	GBP	R <sub>L</sub> = 1 MΩ, C <sub>L</sub> = 35 pF, A <sub>V</sub> = +1		3.6		MHz
Phase Margin	Φ <sub>M</sub>	R <sub>L</sub> = 1 MΩ, C <sub>L</sub> = 35 pF, A <sub>V</sub> = +1		52		Degrees
Turn-On/Turn-Off Time		R <sub>L</sub> = 600 Ω		1		μs
<b>NOISE PERFORMANCE</b>						
Distortion	THD + N	A <sub>V</sub> = -1, R <sub>L</sub> = 2 kΩ, f = 1 kHz, V <sub>IN rms</sub> = 0.8 V rms		0.006		%
		A <sub>V</sub> = -1, R <sub>L</sub> = 600 Ω, f = 1 kHz, V <sub>IN rms</sub> = 0.8 V rms		0.008		%
		A <sub>V</sub> = +1, R <sub>L</sub> = 2 kΩ, f = 1 kHz, V <sub>IN rms</sub> = 0.8 V rms		0.001		%
		A <sub>V</sub> = +1, R <sub>L</sub> = 600 Ω, f = 1 kHz, V <sub>IN rms</sub> = 0.8 V rms		0.003		%
Voltage Noise	e <sub>n</sub> p-p	f = 0.1 Hz to 10 Hz		3.2		μV p-p
Voltage Noise Density	e <sub>n</sub>	f = 1 kHz		16		nV/√Hz
		f = 10 kHz		13		nV/√Hz

## ABSOLUTE MAXIMUM RATINGS

Table 4.

Parameter	Rating
Supply Voltage	6 V
Input Voltage	$V_{SS} - 0.3 \text{ V}$ to $V_{DD} + 0.3 \text{ V}$
Input Current <sup>1</sup>	$\pm 10 \text{ mA}$
Shutdown Pin Rise/Fall Times	50 $\mu\text{s}$ maximum
Differential Input Voltage <sup>2</sup>	$\pm V_{SY}$
Output Short-Circuit Duration to GND	Indefinite
Temperature	
Storage Temperature Range	$-65^{\circ}\text{C}$ to $+150^{\circ}\text{C}$
Operating Temperature Range	$-40^{\circ}\text{C}$ to $+125^{\circ}\text{C}$
Junction Temperature Range	$-65^{\circ}\text{C}$ to $+150^{\circ}\text{C}$
Lead Temperature (Soldering, 60 sec)	$300^{\circ}\text{C}$

<sup>1</sup> Input pins have clamp diodes to the supply pins. Limit the input current to 10 mA or less whenever the input signal exceeds the power supply rail by 0.3 V.

<sup>2</sup> Differential input voltage is limited to 5 V or the supply voltage, whichever is less.

Stresses above those listed under Absolute Maximum Ratings may cause permanent damage to the device. This is a stress rating only; functional operation of the device at these or any other conditions above those indicated in the operational section of this specification is not implied. Exposure to absolute maximum rating conditions for extended periods may affect device reliability.

## THERMAL RESISTANCE

$\theta_{JA}$  is specified for the worst-case conditions, that is, a device soldered in a circuit board for surface-mount packages and measured using a standard 4-layer board, unless otherwise specified.

Table 5. Thermal Resistance

Package Type	$\theta_{JA}$	$\theta_{JC}$	Unit
8-Lead SOIC_N (R-8)	120	45	$^{\circ}\text{C}/\text{W}$
8-Lead LFCSP (CP-8-6)	125	40	$^{\circ}\text{C}/\text{W}$
9-Ball WLCSP (CB-9-3)	77	N/A <sup>1</sup>	$^{\circ}\text{C}/\text{W}$
10-Lead LFCSP (CP-10-11)	115	40	$^{\circ}\text{C}/\text{W}$
16-Lead LFCSP (CP-16-22)	75	12	$^{\circ}\text{C}/\text{W}$
14-Lead TSSOP (RU-14)	112	35	$^{\circ}\text{C}/\text{W}$

<sup>1</sup> N/A = not applicable.

## ESD CAUTION



### ESD (electrostatic discharge) sensitive device.

Charged devices and circuit boards can discharge without detection. Although this product features patented or proprietary protection circuitry, damage may occur on devices subjected to high energy ESD. Therefore, proper ESD precautions should be taken to avoid performance degradation or loss of functionality.

# PIN CONFIGURATIONS

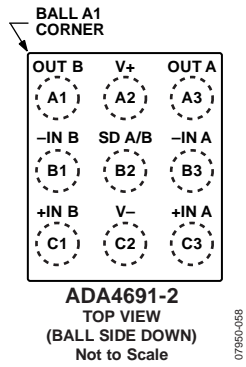

Figure 3. 9-Ball Wafer Level Chip Scale WLCSP (CB-9-3)

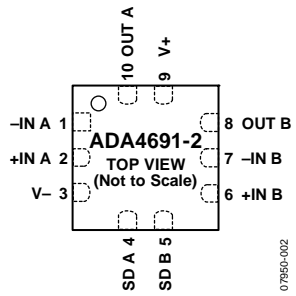
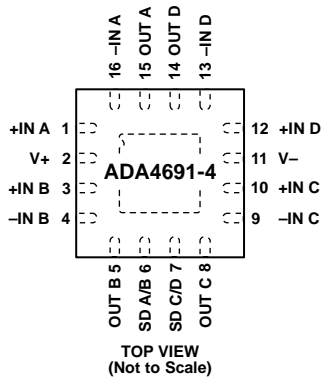

Figure 4. 10-Lead, 2 mm x 2 mm LFCSP (CP-10-11)



**NOTES**  
1. IT IS RECOMMENDED THAT THE EXPOSED PAD BE CONNECTED TO V-.

Figure 5. 16-Lead, 3 mm x 3 mm LFCSP (CP-16-22)

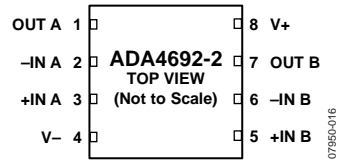

Figure 6. 8-Lead, 2 mm x 2 mm LFCSP (CP-8-6)

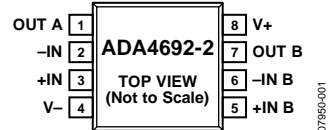

Figure 7. 8-Lead SOIC\_N (R-8)

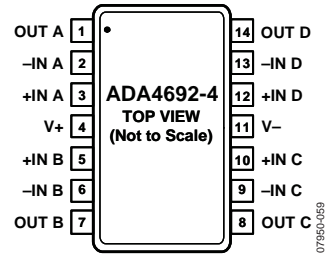

Figure 8. 14-Lead TSSOP (RU-14)

# TYPICAL PERFORMANCE CHARACTERISTICS

T<sub>A</sub> = 25°C, unless otherwise noted.



Figure 9. Input Offset Voltage Distribution



Figure 12. Input Offset Voltage Distribution

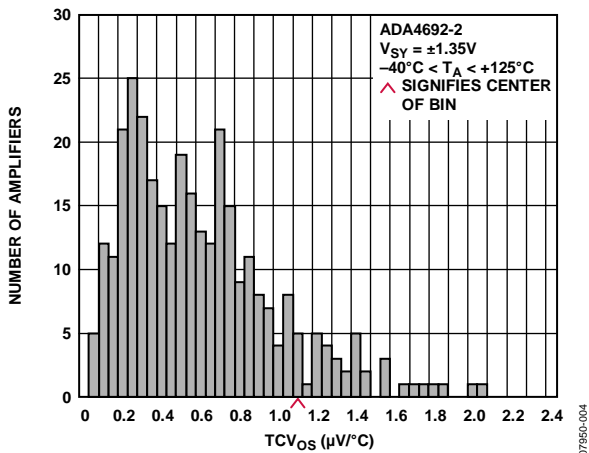

Figure 10. Input Offset Voltage Drift Distribution

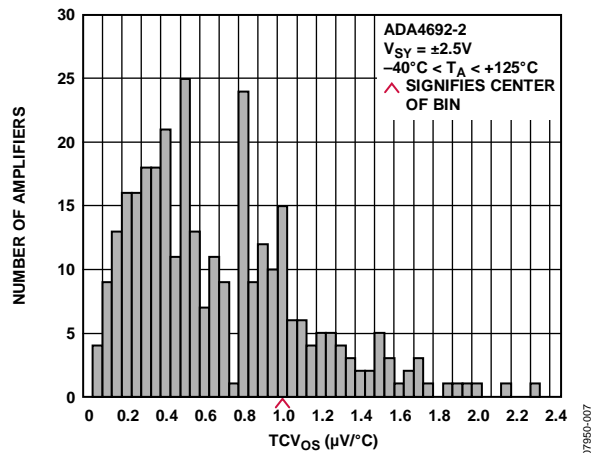

Figure 13. Input Offset Voltage Drift Distribution

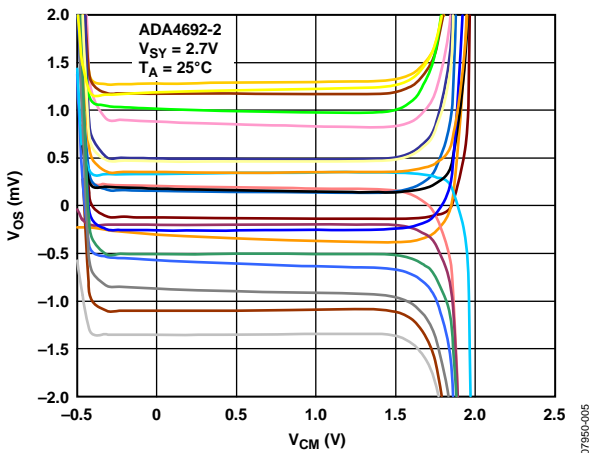

Figure 11. Input Offset Voltage vs. Common-Mode Voltage

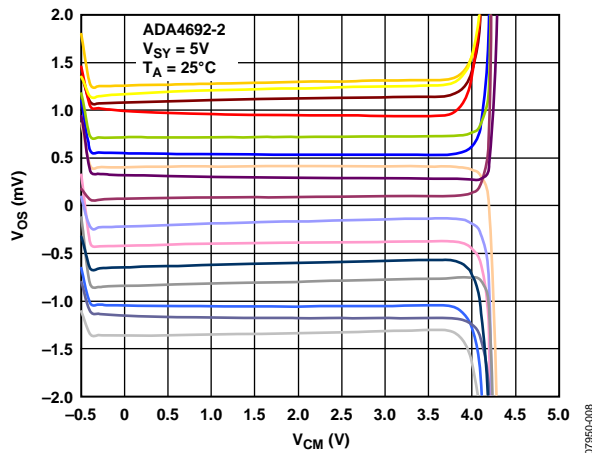

Figure 14. Input Offset Voltage vs. Common-Mode Voltage



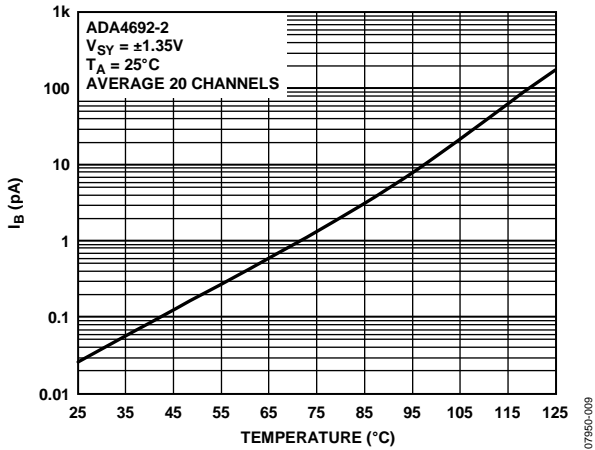

Figure 15. Input Bias Current vs. Temperature

07950-009

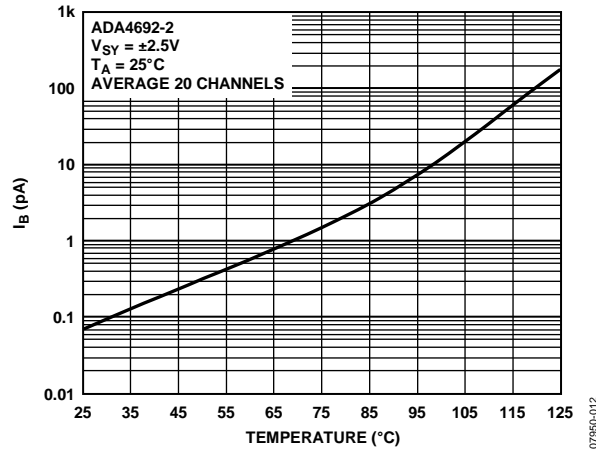

Figure 18. Input Bias Current vs. Temperature

07950-012

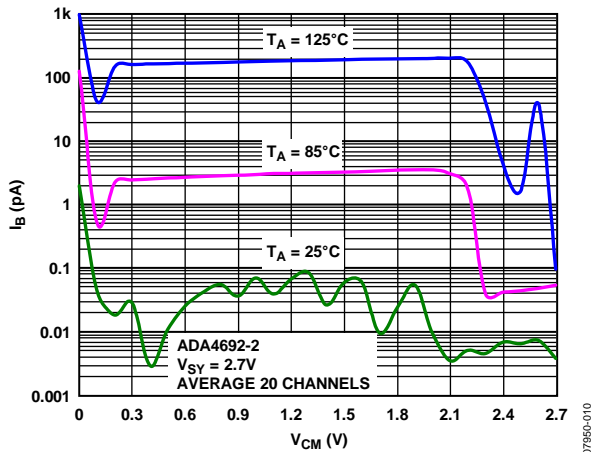

Figure 16. Input Bias Current vs. Common-Mode Voltage

07950-010

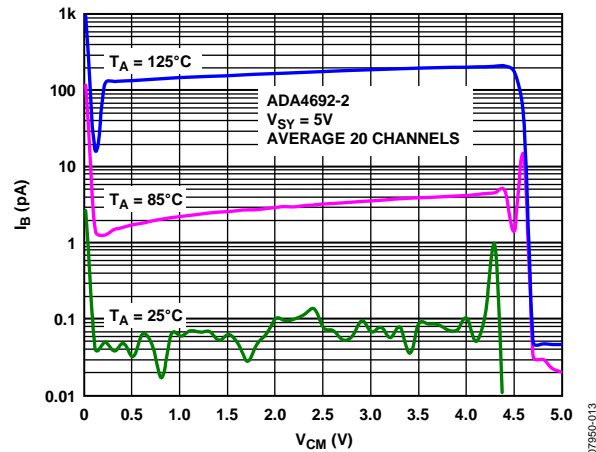

Figure 19. Input Bias Current vs. Common-Mode Voltage

07950-013

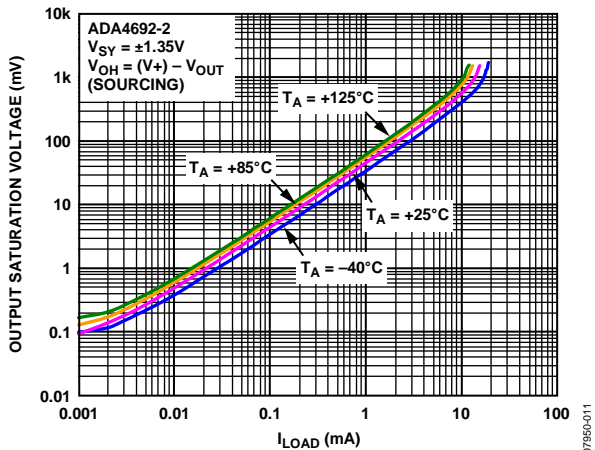

Figure 17. Output Voltage ( $V_{OH}$ ) to Supply Rail vs. Load Current

07950-011

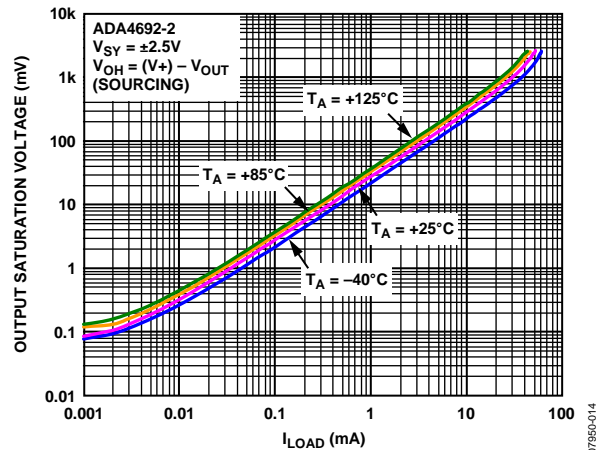

Figure 20. Output Voltage ( $V_{OH}$ ) to Supply Rail vs. Load Current

07950-014

# ADA4691-2/ADA4691-4/ADA4692-2/ADA4692-4

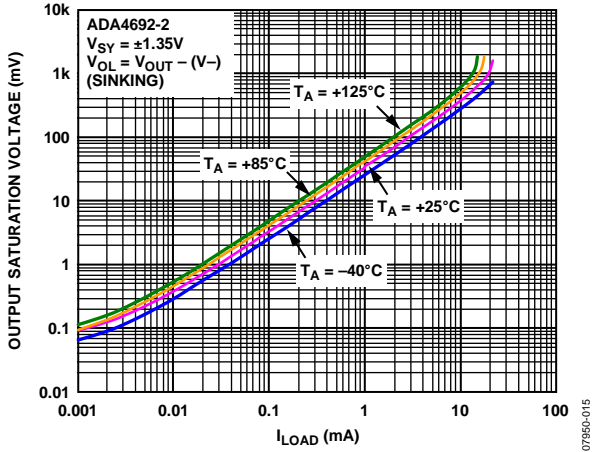

Figure 21. Output Voltage ( $V_{OL}$ ) to Supply Rail vs. Load Current

07950-015

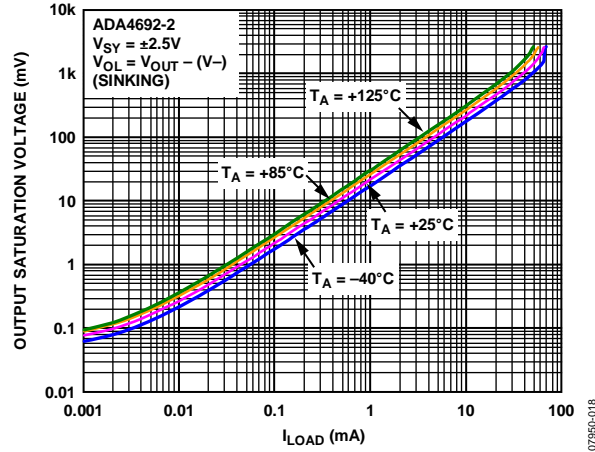

Figure 24. Output Voltage ( $V_{OL}$ ) to Supply Rail vs. Load Current

07950-018

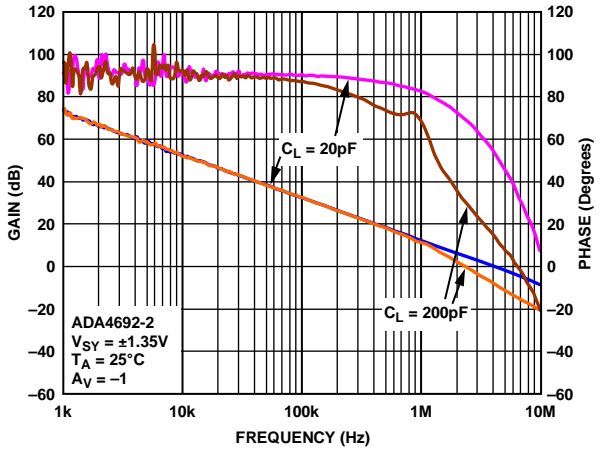

Figure 22. Open-Loop Gain and Phase vs. Frequency

07950-021

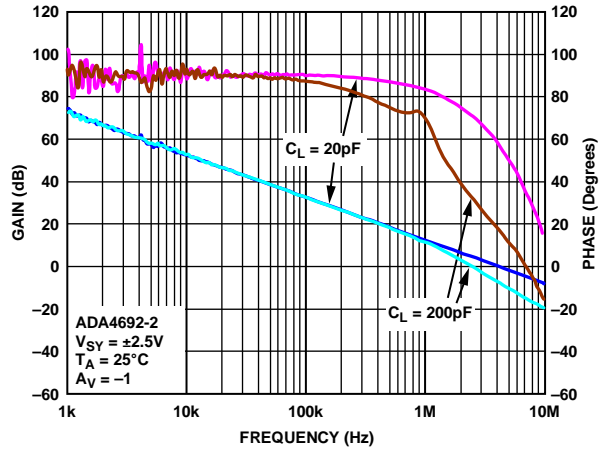

Figure 25. Open-Loop Gain and Phase vs. Frequency

07950-024

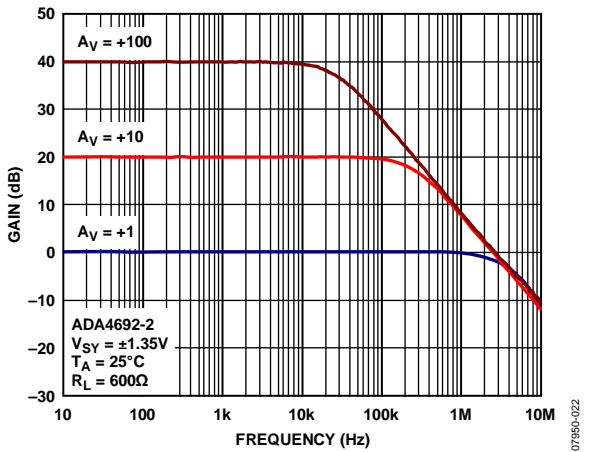

Figure 23. Closed-Loop Gain vs. Frequency

07950-022

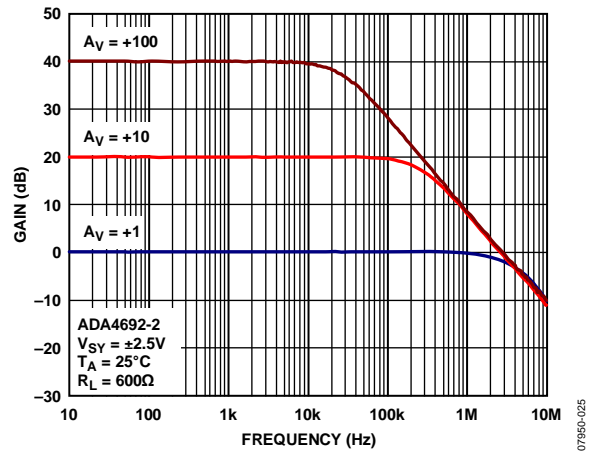

Figure 26. Closed-Loop Gain vs. Frequency

07950-025

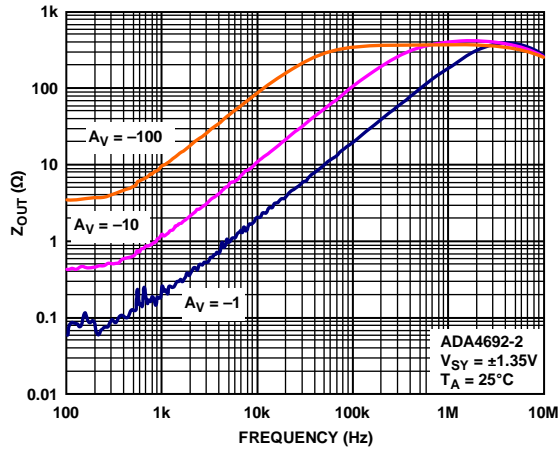

Figure 27. Output Impedance vs. Frequency

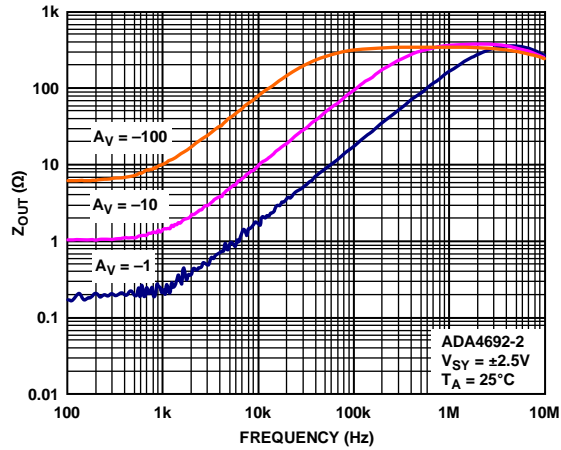

Figure 30. Output Impedance vs. Frequency

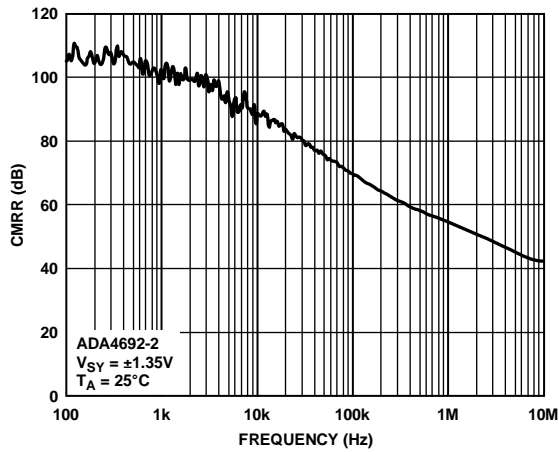

Figure 28. CMRR vs. Frequency

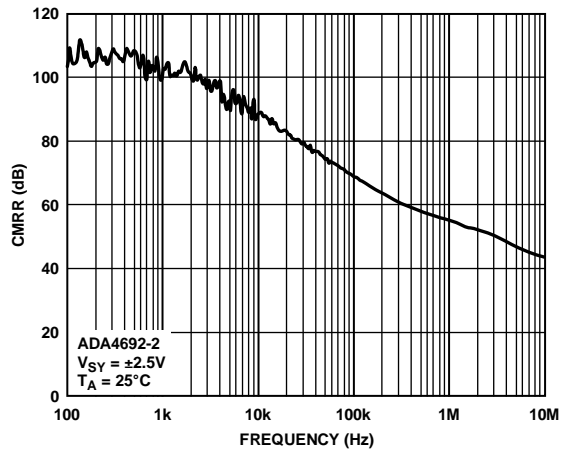

Figure 31. CMRR vs. Frequency

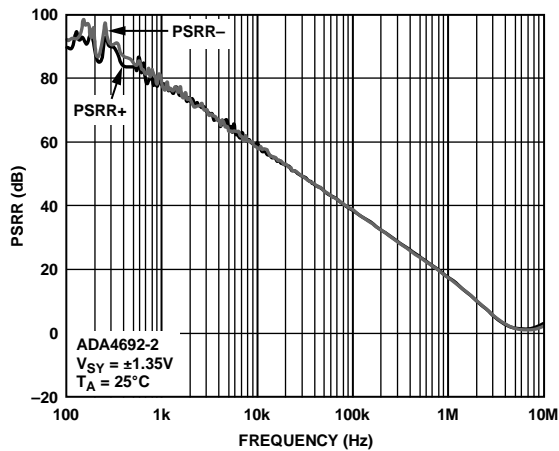

Figure 29. PSRR vs. Frequency

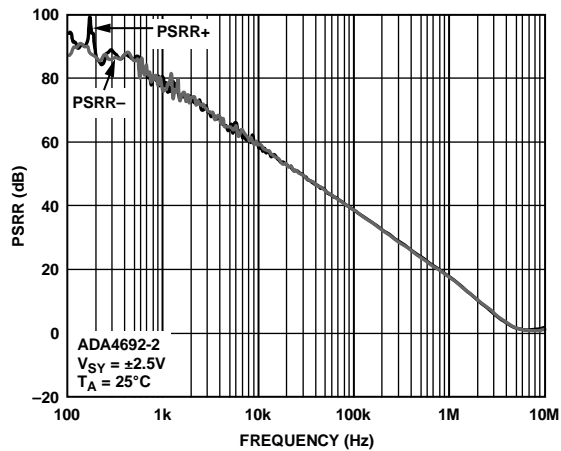

Figure 32. PSRR vs. Frequency

# ADA4691-2/ADA4691-4/ADA4692-2/ADA4692-4

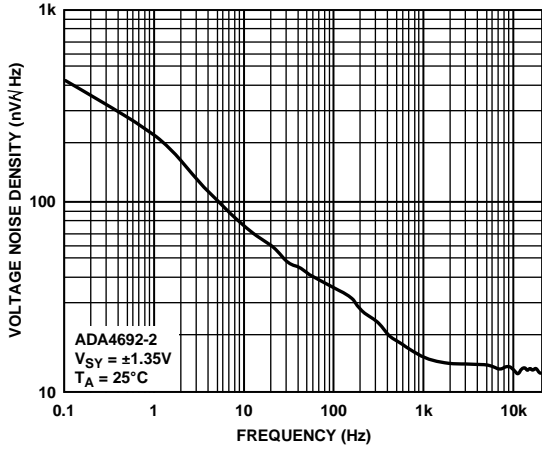

Figure 33. Voltage Noise Density vs. Frequency

07950-029

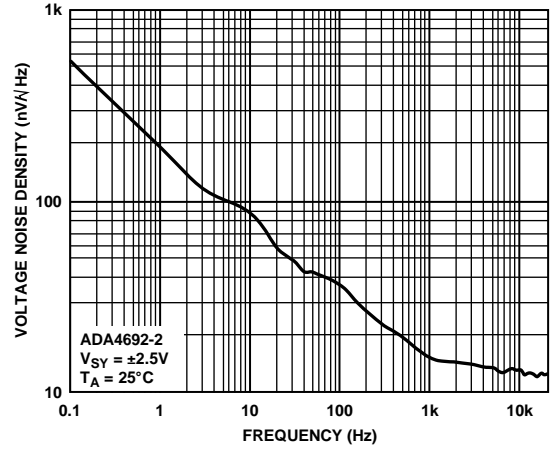

Figure 36. Voltage Noise Density vs. Frequency

07950-032

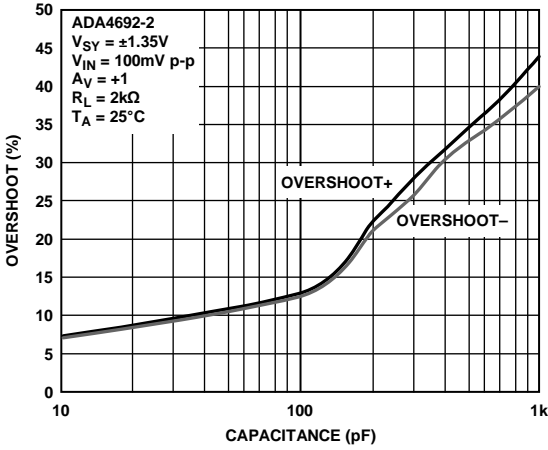

Figure 34. Small Signal Overshoot vs. Load Capacitance

07950-033

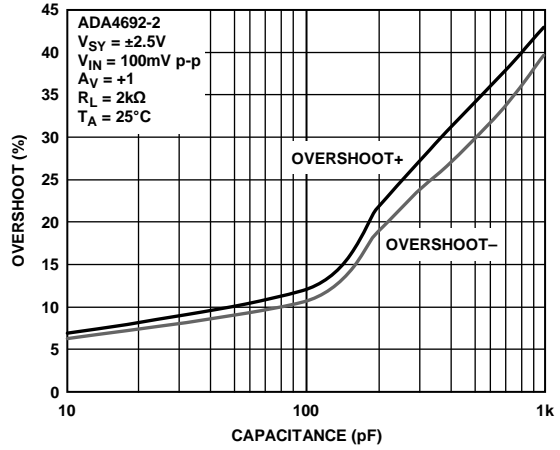

Figure 37. Small Signal Overshoot vs. Load Capacitance

07950-036

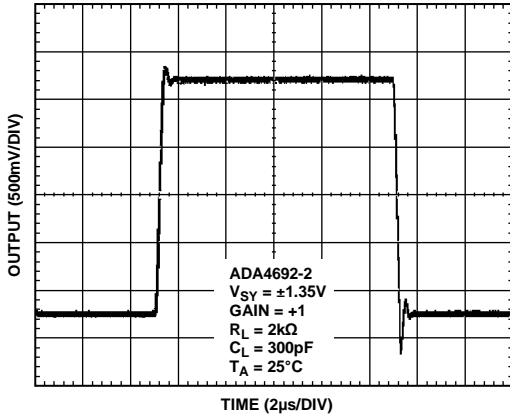

Figure 35. Large Signal Transient Response

07950-034

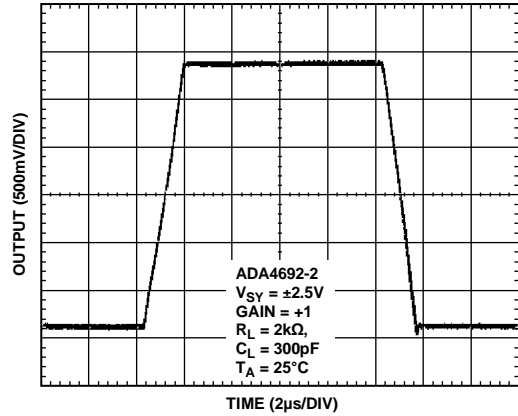

Figure 38. Large Signal Transient Response

07950-037

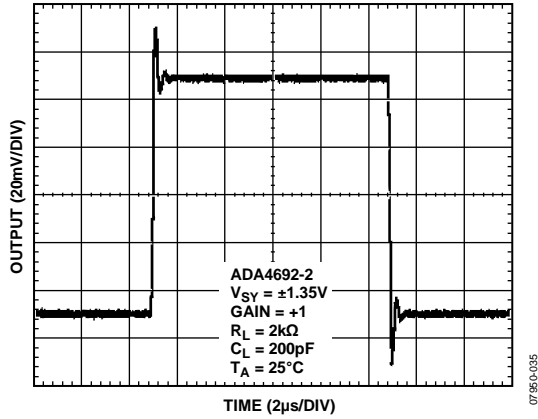

Figure 39. Small Signal Transient Response

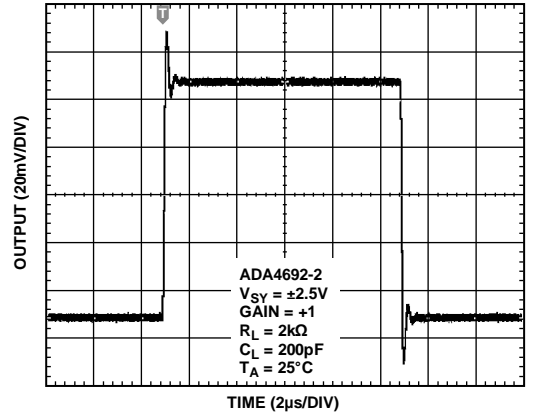

Figure 42. Small Signal Transient Response

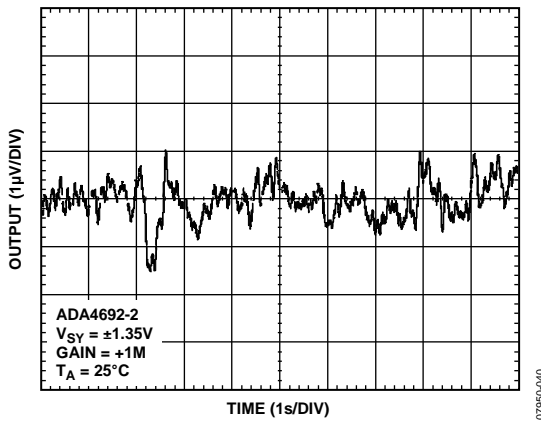

Figure 40. 0.1 Hz to 10 Hz Noise

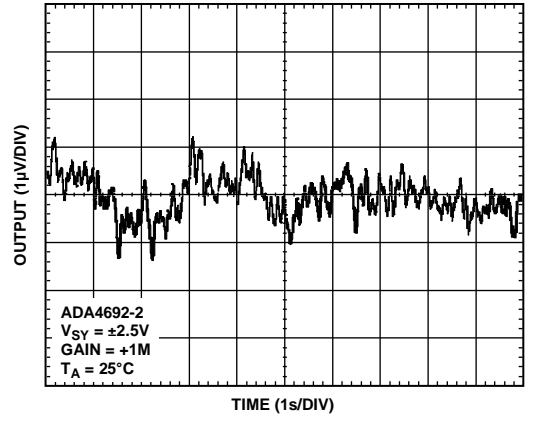

Figure 43. 0.1 Hz to 10 Hz Noise

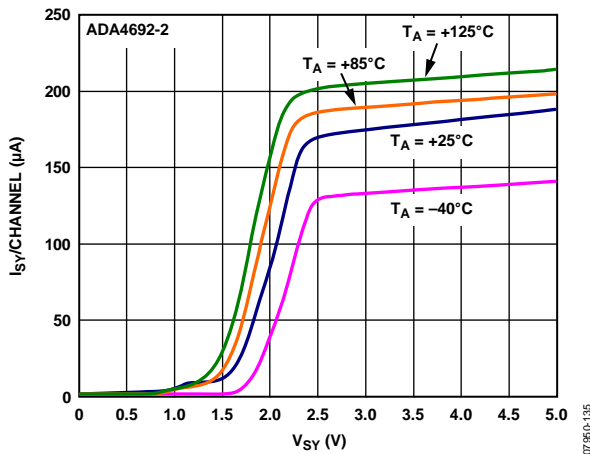

Figure 41. Supply Current per Amplifier vs. Supply Voltage

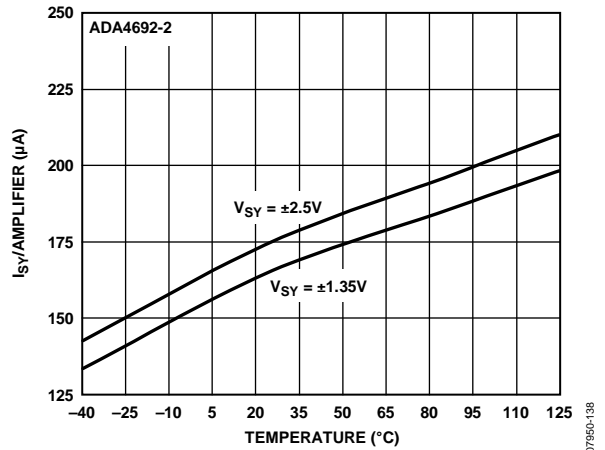

Figure 44. Supply Current per Channel vs. Temperature

# ADA4691-2/ADA4691-4/ADA4692-2/ADA4692-4

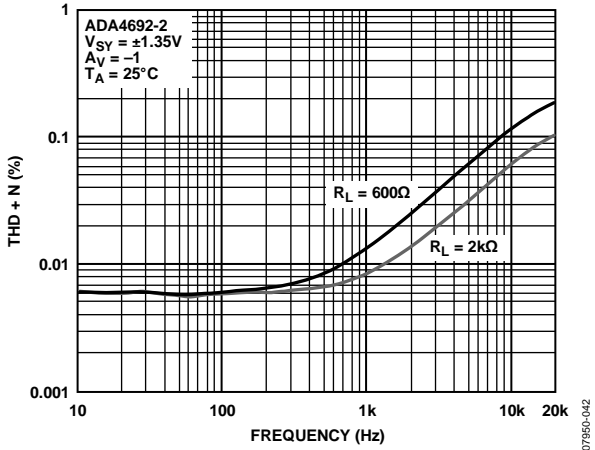

Figure 45. THD + Noise vs. Frequency

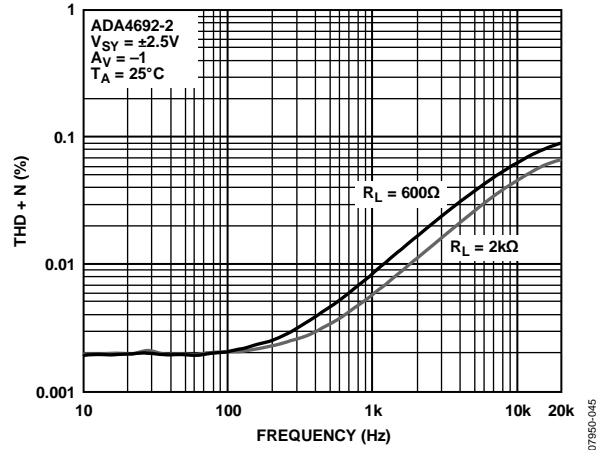

Figure 48. THD + Noise vs. Frequency

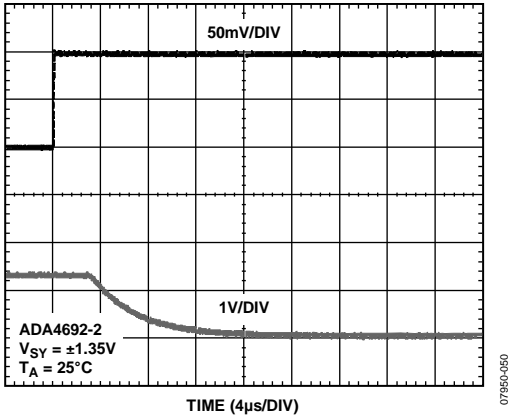

Figure 46. Positive Overload Recovery

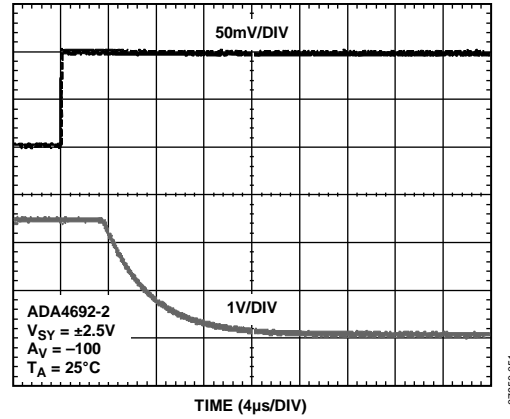

Figure 49. Positive Overload Recovery

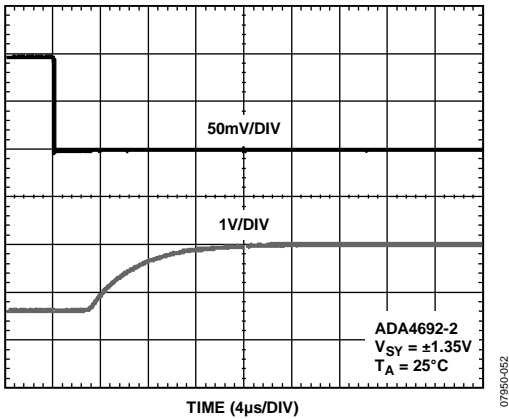

Figure 47. Negative Overload Recovery

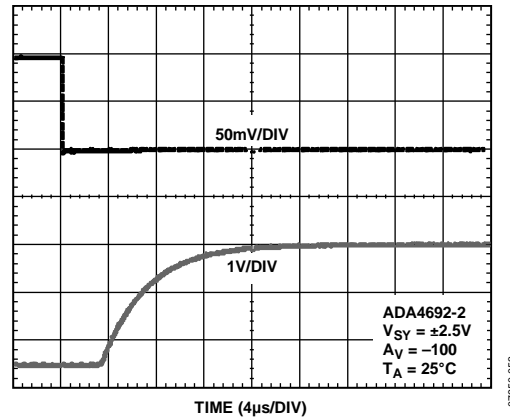
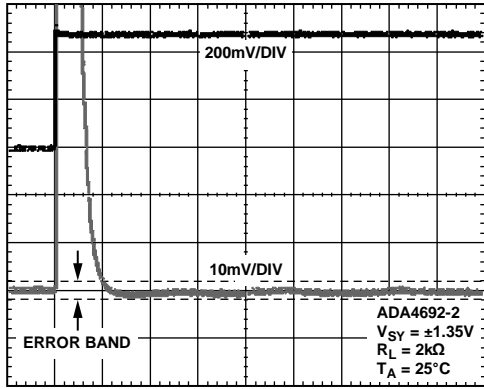

Figure 50. Negative Overload Recovery



TIME (1μs/DIV)

Figure 51. Positive Settling Time to 0.1%

07950-054

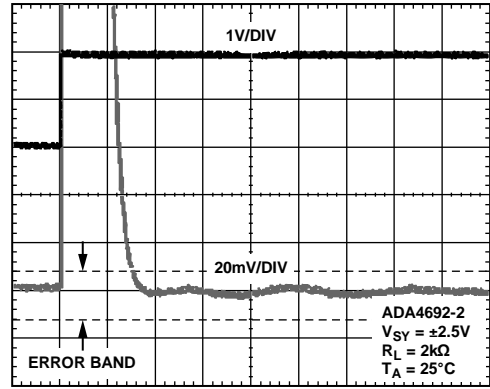

TIME (1μs/DIV)

Figure 54. Positive Settling Time to 0.1%

07950-055

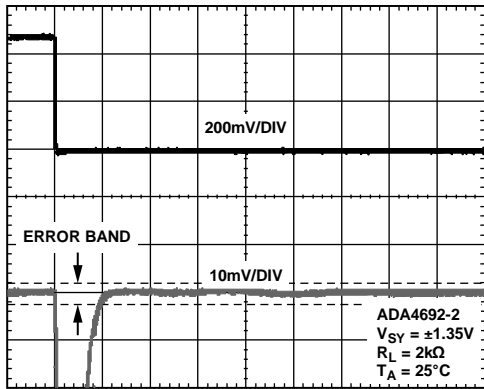

TIME (1μs/DIV)

Figure 52. Negative Settling Time to 0.1%

07950-056

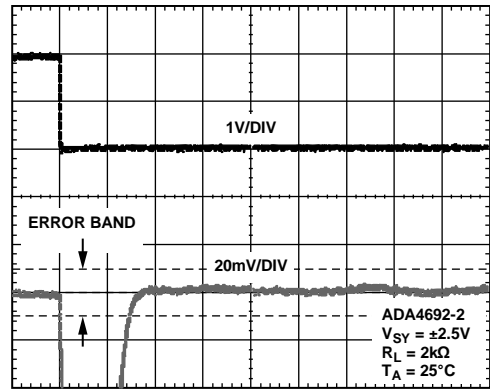

TIME (1μs/DIV)

Figure 55. Negative Settling Time to 0.1%

07950-057

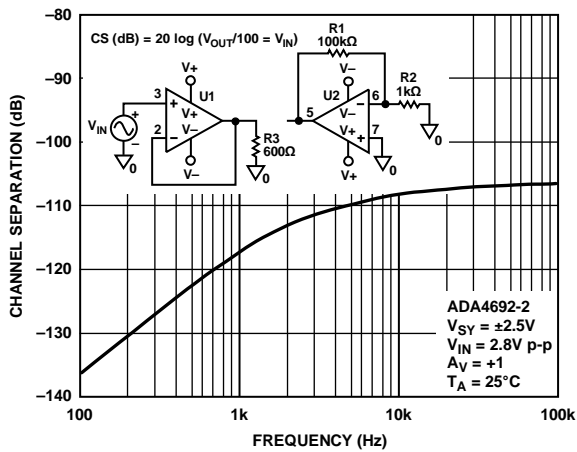

Figure 53. Channel Separation (CS) vs. Frequency

07950-140

## SHUTDOWN OPERATION

### INPUT PIN CHARACTERISTICS

The ADA4691-2 has a classic CMOS logic inverter input for each shutdown pin, as shown in Figure 56.

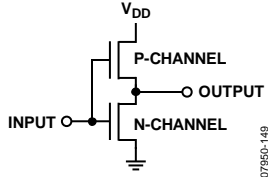

Figure 56. CMOS Inverter

With slowly changing inputs, the top transistor and bottom transistor may be slightly on at the same time, increasing the supply current. This can be avoided by driving the input with a digital logic output having fast rise and fall times. Figure 57 through Figure 59 show the supply current for both sections switching simultaneously with rise times of 1  $\mu$ s, 10  $\mu$ s, and 1 ms. Clearly, the rise and fall times should be faster than 10  $\mu$ s. Using an RC time constant to enable/disable shutdown is not recommended.

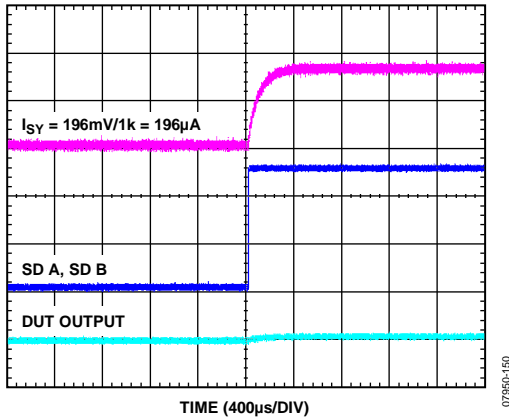

Figure 57. Shutdown Pin Rise Time = 1  $\mu$ s

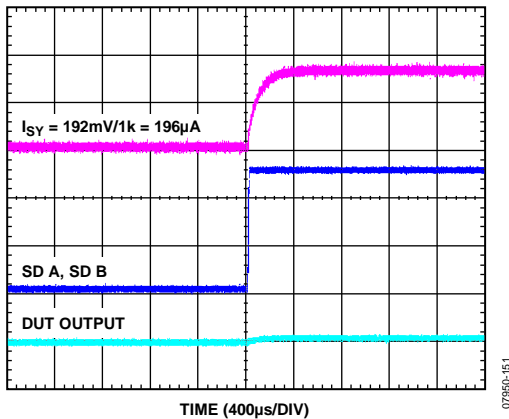

Figure 58. Shutdown Pin Rise Time = 10  $\mu$ s

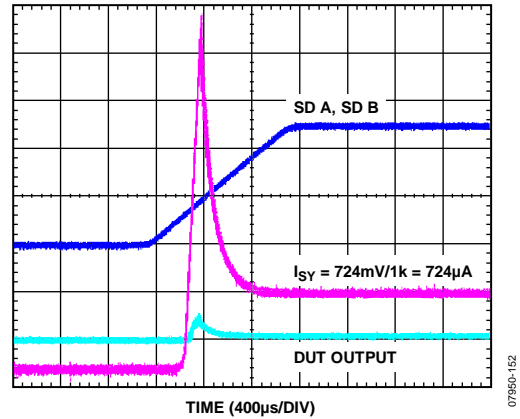

Figure 59. Shutdown Pin Rise Time = 1 ms

### INPUT THRESHOLD

The input threshold is approximately 1.2 V above the V- pin when operating on ground and 5 V and 0.9 V when operating on 2.7 V (see Figure 60 and Figure 61). The threshold is relatively stable over temperature. For operation on split supplies, the logic swing may have to be level shifted.

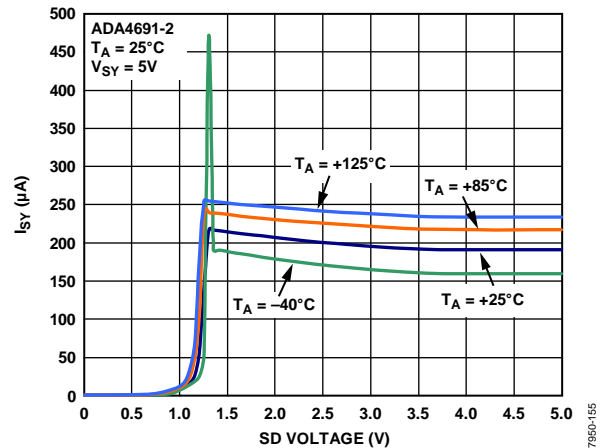

Figure 60. Supply Current vs. Temperature,  $V_{SY} = 5 V$

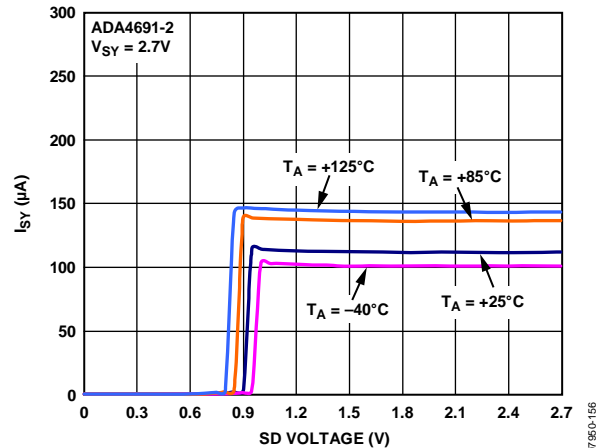
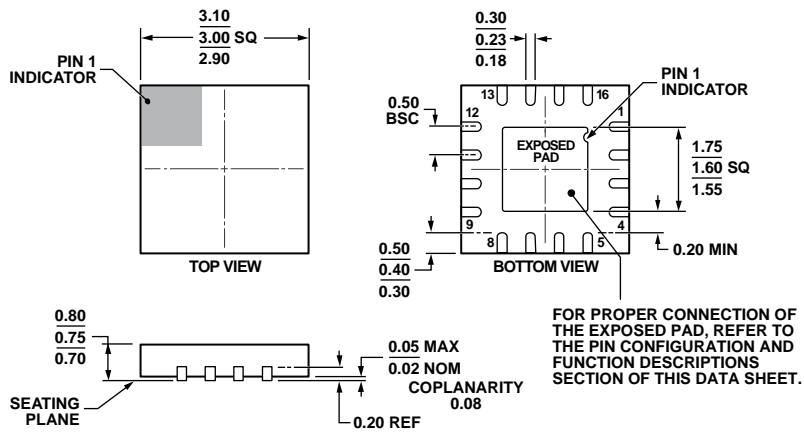

Figure 61. Supply Current vs. Temperature,  $V_{SY} = 2.7 V$



OUTLINE DIMENSIONS



COMPLIANT TO JEDEC STANDARDS MO-220-WEED.

Figure 62. 16-Lead Lead Frame Chip Scale Package [LFCSP\_WQ]  
3 mm × 3 mm Body, Very Very Thin Quad  
(CP-16-22)

Dimensions shown in millimeters

070209-C

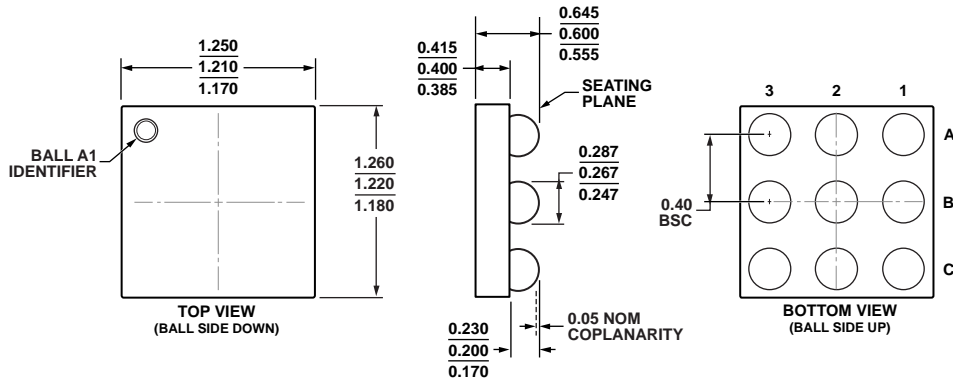
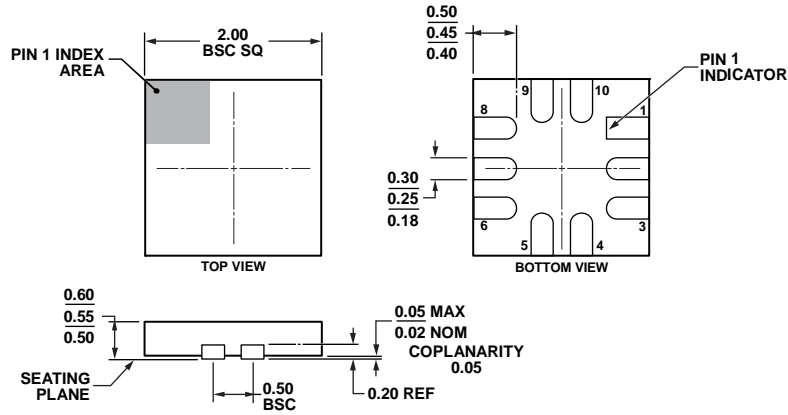

Figure 63. 9-Ball Wafer Level Chip Scale Package [WLCSP]  
(CB-9-3)

Dimensions shown in millimeters

091709-A



081308-D

Figure 64. 10-Lead Lead Frame Chip Scale Package [LFCSP\_UQ]  
 2 mm x 2 mm Body, Ultra Thin Quad  
 (CP-10-11)  
 Dimensions shown in millimeters

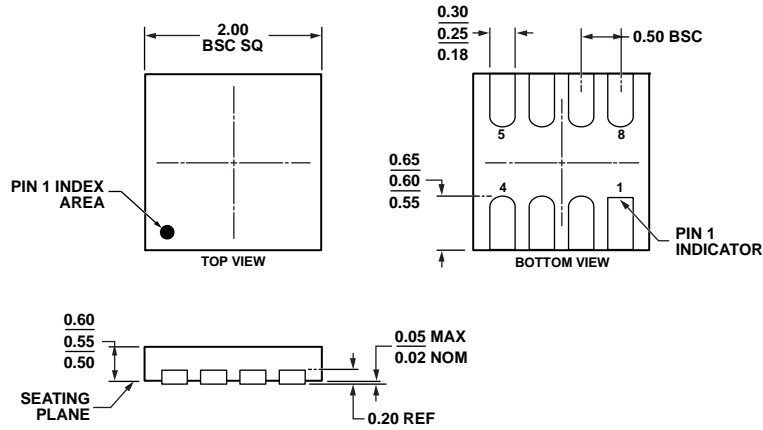

062409-A

Figure 65. 8-Lead Lead Frame Chip Scale Package [LFCSP\_UD]  
 2 mm x 2 mm Body, Ultra Thin, Dual Lead  
 (CP-8-6)  
 Dimensions shown in millimeters

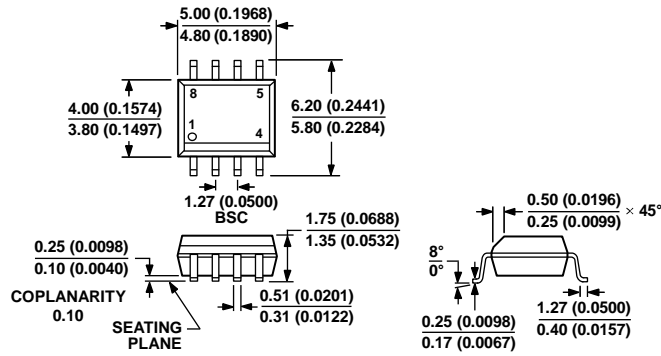

COMPLIANT TO JEDEC STANDARDS MS-012-A A  
 CONTROLLING DIMENSIONS ARE IN MILLIMETERS; INCH DIMENSIONS  
 (IN PARENTHESES) ARE ROUNDED-OFF MILLIMETER EQUIVALENTS FOR  
 REFERENCE ONLY AND ARE NOT APPROPRIATE FOR USE IN DESIGN.

012A07-A

Figure 66. 8-Lead Standard Small Outline Package [SOIC\_N]  
 Narrow Body  
 (R-8)

Dimensions shown in millimeters and (inches)

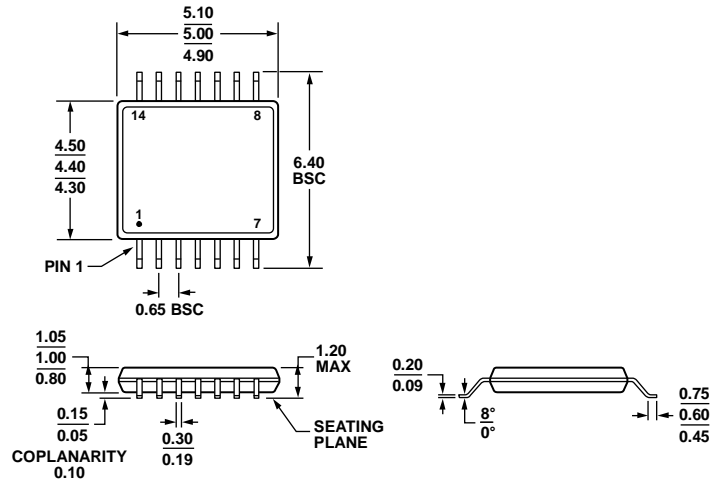

COMPLIANT TO JEDEC STANDARDS MO-153-AB-1

Figure 67. 14-Lead Thin Shrink Small Outline Package [TSSOP]  
 (RU-14)

Dimensions shown in millimeters

061906-A

# ADA4691-2/ADA4691-4/ADA4692-2/ADA4692-4

## ORDERING GUIDE

Model <sup>1</sup>	Temperature Range	Package Description	Package Option	Branding
ADA4691-2ACBZ-R7	-40°C to +125°C	9-Ball WLCSP	CB-9-3	A2C
ADA4691-2ACBZ-RL	-40°C to +125°C	9-Ball WLCSP	CB-9-3	A2C
ADA4691-2ACPZ-R7	-40°C to +125°C	10-Lead LFCSP_UQ	CP-10-11	A2
ADA4691-2ACPZ-RL	-40°C to +125°C	10-Lead LFCSP_UQ	CP-10-11	A2
ADA4691-4ACPZ-R2	-40°C to +125°C	16-Lead LFCSP_WQ	CP-16-22	A2P
ADA4691-4ACPZ-R7	-40°C to +125°C	16-Lead LFCSP_WQ	CP-16-22	A2P
ADA4691-4ACPZ-RL	-40°C to +125°C	16-Lead LFCSP_WQ	CP-16-22	A2P
ADA4692-2ACPZ-R7	-40°C to +125°C	8-Lead LFCSP_UD	CP-8-6	A3
ADA4692-2ACPZ-RL	-40°C to +125°C	8-Lead LFCSP_UD	CP-8-6	A3
ADA4692-2ARZ	-40°C to +125°C	8-Lead SOIC_N	R-8	
ADA4692-2ARZ-R7	-40°C to +125°C	8-Lead SOIC_N	R-8	
ADA4692-2ARZ-RL	-40°C to +125°C	8-Lead SOIC_N	R-8	
ADA4692-4ARUZ	-40°C to +125°C	14-Lead TSSOP	RU-14	
ADA4692-4ARUZ-RL	-40°C to +125°C	14-Lead TSSOP	RU-14	

<sup>1</sup> Z = RoHS Compliant Part.



Компания «ЭлектроПласт» предлагает заключение долгосрочных отношений при поставках импортных электронных компонентов на взаимовыгодных условиях!

Наши преимущества:

- Оперативные поставки широкого спектра электронных компонентов отечественного и импортного производства напрямую от производителей и с крупнейших мировых складов;
- Поставка более 17-ти миллионов наименований электронных компонентов;
- Поставка сложных, дефицитных, либо снятых с производства позиций;
- Оперативные сроки поставки под заказ (от 5 рабочих дней);
- Экспресс доставка в любую точку России;
- Техническая поддержка проекта, помощь в подборе аналогов, поставка прототипов;
- Система менеджмента качества сертифицирована по Международному стандарту ISO 9001;
- Лицензия ФСБ на осуществление работ с использованием сведений, составляющих государственную тайну;
- Поставка специализированных компонентов (Xilinx, Altera, Analog Devices, Intersil, Interpoint, Microsemi, Aeroflex, Peregrine, Syfer, Eurofarad, Texas Instrument, Miteq, Cobham, E2V, MA-COM, Hittite, Mini-Circuits, General Dynamics и др.);

Помимо этого, одним из направлений компании «ЭлектроПласт» является направление «Источники питания». Мы предлагаем Вам помощь Конструкторского отдела:

- Подбор оптимального решения, техническое обоснование при выборе компонента;
- Подбор аналогов;
- Консультации по применению компонента;
- Поставка образцов и прототипов;
- Техническая поддержка проекта;
- Защита от снятия компонента с производства.



#### Как с нами связаться

**Телефон:** 8 (812) 309 58 32 (многоканальный)

**Факс:** 8 (812) 320-02-42

**Электронная почта:** [org@eplast1.ru](mailto:org@eplast1.ru)

**Адрес:** 198099, г. Санкт-Петербург, ул. Калинина, дом 2, корпус 4, литера А.