

# Manual Switches

## Pushbutton Switches and Indicators



Bezel on all sides



Barriers on short sides



Barriers on long sides

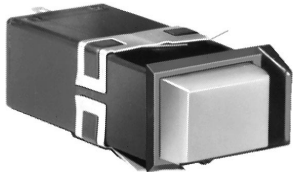

Barrier on one short side



Barriers on one long side

### FEATURES

- Provides distinctive color display whether lighted or unlighted.
- Convenient front panel mounting and relamping, without tools.
- Matching indicators.
- Locked button option discourages tampering.
- Choice of transmitted color, projected color, or dead front display.
- UL recognized, CSA certified.

### MOUNTING

Snap-in mounting. Switch or indicator is easily inserted into the cutout. Mounting clips grip the panel. No tools are needed.



Housings with a full bezel can be front panel or sub-panel mounted, individually or in strips.

Barrier type housings are normally mounted top-of-panel in strips, but can also be individually mounted. Barriers can be on either the short or long housing sides.

The drawing shows how housings with a barrier on one side are used in a strip of two or more units. The first has a barrier on two sides, while all other units have a barrier on one side, and butt against each other.



Button



Incandescent Lamp

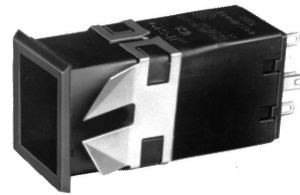

Housing

### RELAMPING



1. Lamps and legends can be changed from panel front. When button is removed, lamp is extracted from its socket and retained in button.

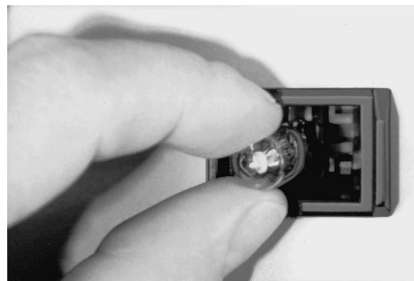

2. Ease of lamp replacement. After the inoperative lamp is automatically removed with the button, the new lamp is inserted without the use of tools.

### ELECTRICAL RATINGS

5-amp silver contacts —  
5 amps res., 3 amps ind., 30 VDC.  
UL code L-4: 5 amps, 250 VAC

10-amp silver contacts —  
UL code L-285; 10 amps, 1/8 Hp, 125 or 250 VAC.

Gold contacts —  
1 amp res., 0.5 amp, ind., 30 VDC  
UL code L-22: 1 amp, 125 VAC

Gold alloy contacts —  
0.1 amp, res., 30 VDC;  
1 amp, 125 VAC.

### LOCKED BUTTON OPTION

Series 4 can be furnished with a locked button option for use in areas accessible to the public, where tampering and vandalism are problems. The housing has a special mounting clip with built-in button retainer. This mounting clip must be removed from behind panel to allow button removal. Button movement during switch operation is unaffected by locked button feature. (These units cannot be relamped from front of panel.)

Pushbutton Switches and Indicators

SWITCH HOUSING ORDER GUIDE

Order buttons separately from page 109.

**4A11B**

Switch Housing Style (Black)
<p><b>4A11B</b> Bezel: all sides Mtg. clips: long sides</p> <p><b>4A34B</b> Barrier: one long side Mtg. clips: short sides</p> <p><b>4A21B</b> Barriers: short sides Mtg. clips: long sides</p> <p><b>4A23B</b> Barrier: one short side Mtg. clips: long sides</p>
With Housing Provision for Locked Button
<p><b>4A13B</b> Bezel: all sides Mtg. clips: long sides</p> <p><b>4A25B</b> Barriers: short sides Mtg. clips: long sides</p> <p><b>4A26B</b> Barrier: one short side Mtg. clips: long sides</p>

**AA**

Switching Element		
Electrical Data	Action	Terminals
		.110 QC
1-Pole (SPDT), 5 a. silver contacts	Momentary	AA
	Alt. Action	BA
2-Pole (DPDT), 5 a. silver contacts	Momentary	EA
	Alt. Action	FA
2-Pole (DPDT), 10 a. silver contacts	Momentary	NA
	Alt. Action	PA

**11**

Incandescent Illumination
<p><b>11</b> No lamp, has lamp socket for T-3/4 wedge base lamps.</p> <p><b>21</b> #161 12-volt T-3/4 lamp.</p> <p><b>31</b> #656 or 152 28-volt T-3/4 lamp</p> <p><b>91</b> Unlighted, no lamp socket.</p>

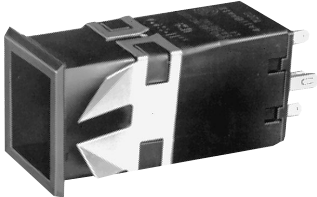

Example:  
**4A11BAA11**  
Black switch housing with a bezel on all sides, mounting clips on long sides, 1-pole momentary-action 5-amp silver contacts, .110" quick-connect/solder terminals, and a T-3/4 lamp socket.

**MOUNTING CLIP ORIENTATION**

Mounting clips on the **long sides** of the housing are specified when individually mounted or when the long sides of strip mounting housings parallel the long sides of the panel cutout slot. The most secure mounting is achieved when the mounting clips are on the long sides.

Mounting clips on the **short sides** of the housing are specified when short sides of strip mounted housings parallel the long sides of the panel cutout slot.

# Manual Switches

## Pushbutton Switches and Indicators

### BUTTON ORDER GUIDE



\*To be ordered with switch.

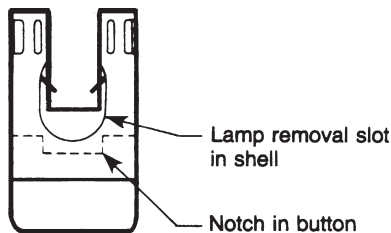
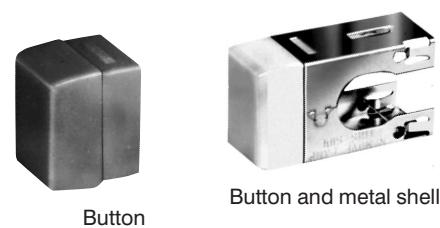

Note: legended button should be assembled as shown above, with button notch keyed to lamp removal slot in shell. This will reduce possibility of lamp droppage when button is removed from the housing. Buttons are legended in this manner.

Example:  
**4B1AGN**  
Green (transmitted color) unlegended button. (If the button shell is also desired, substitute 4B2 for 4B1.)

### LEGENDING

#### Pad printed legends

Use Legend Order Sheet FO-63039 (see page 110) to specify pad printed legends. Reproduce it on your office copier. Legends are oversprayed for maximum durability.

#### Film legends

Film legends are not supplied by MICRO SWITCH. However, this service is readily available from commercial sources or may be provided through your in-house capabilities. The film should be polyester to withstand lamp heat and must be precision cut, per the dimensions shown on the next page, to insure proper alignment.

The film fits into a small undercut on the face of the button insert. The film is held securely when the outer button and insert are snapped together. (Note: It is difficult to disassemble for legend changes without damaging the parts.)

Button and insert should be snapped together prior to being assembled to the button shell.

Manuals

# Manual Switches

## Pushbutton Switches and Indicators

### LAMP ORDER GUIDE

Catalog Listing	Illum. Code	Incandescent Lamp Description
4Z231	31	#656 or #152 28-volt (T-3¼)

### LAMP DATA

Following data was compiled from manufacturers' specifications and is provided for reference only.

Illum. Code	Industry Lamp No.	Design Volts	Incandescent Lamp Specifications			
			Socket volts	Amps	MSCP	Life (hrs. avg.)
31	656 or 152	28	28.0	.06	.65	5,000
			27.0	.057	.52	7,500
			26.0	.054	.49	10,000

### METAL SHELL ORDER GUIDE

Catalog Listing	Description
4Z41	For type 4B1 buttons

### MOUNTING CENTERS FOR STRIP MOUNT

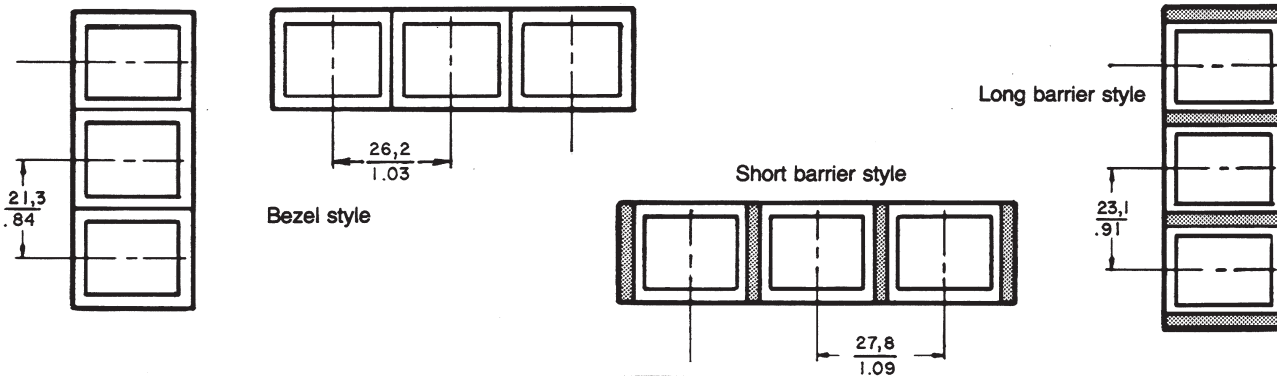

### PANEL CUTOUT FOR STRIP MOUNT

	Housing Style	Dimensions $+0,38 +.015$ $-0,00 -.000$	
		Width	Length
Short Sides Abutting	Full Bezel	79" (20,1 mm)	[No. of units x 1.03" (26,2 mm)] - .05" (1,4 mm)
	Short Barrier	79" (20,1 mm)	[No. of units x 1.09" (27,8 mm)] - .12" (3,0 mm)
Long Sides Abutting	Full Bezel	.98" (24,8 mm)	[No. of units x .84" (21,3 mm)] - .05" (1,4 mm)
	Long Barrier	.98" (24,8 mm)	[No. of units x .91" (23,1 mm)] - .12" (3,0 mm)

### PANEL CUTOUT FOR INDIVIDUAL MOUNT (any housing style)

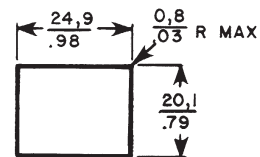

# Manual Switches

## Pushbutton Switches and Indicators

### MOUNTING DIMENSIONS (For reference only)



△ Terminal View

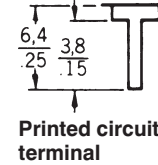
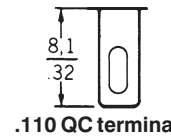

Panel thickness: .040-.200 in. (1.02-5.08 mm)

Key: 0,0 = mm  
0.00 = inches

△ For proper legend orientation, Series 4 switch when viewed from front of panel, should have terminals 1 and 3 up for Figures 1 & 3 and to the right for Figures 2 and 4. (Figures 1-4 on Legend Order Sheet next page.)

Quick-connect terminals are .110" (2,8 mm) wide by .020" (0,5 mm) thick. The slot is .130" (3,3 mm) long by .048" (1,2 mm). Printed circuit terminals are: Lamp — .025 (0,6 mm) by .020" (0,5 mm); Switch — .025" (0,6 mm) square.

All terminals are plated to permit soldering.

Type A Button  
(5 sides lighted)

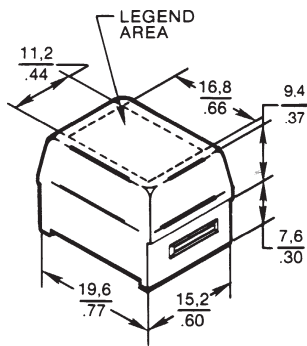

Translucent Colored Button

Type E Button  
(5 sides lighted)

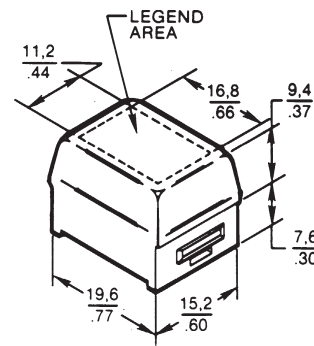

Transparent Button  
Colorless

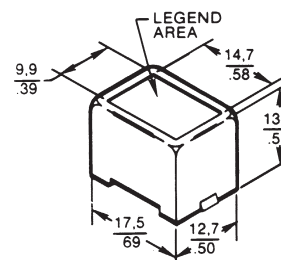
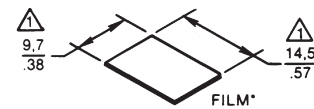

Translucent Colored Insert

±.005/0,13

\*Thickness: .004" to .007"/0,1 to 0,18 (Film furnished by customer)

Pushbuttons

## Pushbutton Switches and Indicators

# Honeywell

### "Series 4" Legend Order Sheet

ACCOUNT NO. \_\_\_\_\_

- Determine if legend is to be applied to outer button shell, or to button insert.
- Select appropriate Fig. No. from Chart "A" or "B", and enter on legend order chart.
- Place ✓ in appropriate "TYPE SIZE" column (refer to CHART "C" for examples).
- Place ✓ in BLACK or WHITE legend color column.
- Indicate quantity desired.
- Fill in legend description. (DO NOT EXCEED MAXIMUM NUMBER OF LINES OR

Catalog Listing 4	
Customer P.O. No.	Customer Dwg. No.
MICRO SWITCH Sales Order	Schedule No.

Customer: \_\_\_\_\_  
 Address: \_\_\_\_\_

Legend Area	A Button: Legend on Top Surface		B Button Insert: Legend on Top Surface		C		D	
	Type Size	Without An "M" or "W"	With An "M" or "W"	Type Size	Without An "M" or "W"	With An "M" or "W"	Without An "M" or "W"	With An "M" or "W"
Fig. 1	5/64	9 4 4 9 4 4	7 3 7 3 7 3	5/64	7 3 7 3 7 3	5 2 5 2 5 2	7 3 7 3 7 3	5 2 5 2 5 2
Fig. 2	7/64	7 3 6 3 5 4 4 4	5 2 5 2 5 2	7/64	5 2 5 2 5 2	5 1 5 1 5 1	5 2 5 2 5 2	5 1 5 1 5 1
	9/64	6 2 5 2 4 3 4 3	5 1 5 1 5 1	9/64	5 1 5 1 5 1	3 1 3 1 3 1	3 2 3 2 3 2	3 1 3 1 3 1
	13/64	4 1 3 1 3 1 2 2 2 2	3 1 3 1 3 1	13/64	3 1 3 1 3 1	2 1 2 1 2 1	2 2 2 2 2 2	2 1 2 1 2 1
	5/16	2 1 2 1 2 1 1 1 1 1	2 1 2 1 2 1	5/16	2 1 2 1 2 1	1 1 1 1 1 1	1 1 1 1 1 1	1 1 1 1 1 1

Modified Gothic (A thru Z), numerals (0 thru 9) and Symbols below available in 5/64, 7/64, 9/64, 13/64 and 5/16.

·	,	:	;	!	?	'	-	"	/	(	)	*	&
\$	¢	#	%	°	+	-	±	÷	x	=	≠	>	<
→	↖	↗	↘	↙	↚	↛	↜	↝	↞	↠	↡	↢	↣

STANDARD SYMBOLS AVAILABLE

**SPECIAL LEGENDS**  
 NOTE: Use this area to show special Legend Locations or Configurations NOT shown above. NON-STANDARD legends will involve additional charges and increased delivery time.

Customer Part No	Fig No	Type Size			Ink Color	Button Qty	Legend Description
		7/64	9/64	13/64			
							Do Not Exceed Maximum Number of Lines or Characters
							Sequence: Left-to-Right or Top-to-Bottom
							1st Line
							2nd Line
							3rd Line
							4th Line
							5th Line

FO-63035-B (Signature) \_\_\_\_\_ (Date) \_\_\_\_\_



Компания «ЭлектроПласт» предлагает заключение долгосрочных отношений при поставках импортных электронных компонентов на взаимовыгодных условиях!

Наши преимущества:

- Оперативные поставки широкого спектра электронных компонентов отечественного и импортного производства напрямую от производителей и с крупнейших мировых складов;
- Поставка более 17-ти миллионов наименований электронных компонентов;
- Поставка сложных, дефицитных, либо снятых с производства позиций;
- Оперативные сроки поставки под заказ (от 5 рабочих дней);
- Экспресс доставка в любую точку России;
- Техническая поддержка проекта, помощь в подборе аналогов, поставка прототипов;
- Система менеджмента качества сертифицирована по Международному стандарту ISO 9001;
- Лицензия ФСБ на осуществление работ с использованием сведений, составляющих государственную тайну;
- Поставка специализированных компонентов (Xilinx, Altera, Analog Devices, Intersil, Interpoint, Microsemi, Aeroflex, Peregrine, Syfer, Eurofarad, Texas Instrument, Miteq, Cobham, E2V, MA-COM, Hittite, Mini-Circuits, General Dynamics и др.);

Помимо этого, одним из направлений компании «ЭлектроПласт» является направление «Источники питания». Мы предлагаем Вам помощь Конструкторского отдела:

- Подбор оптимального решения, техническое обоснование при выборе компонента;
- Подбор аналогов;
- Консультации по применению компонента;
- Поставка образцов и прототипов;
- Техническая поддержка проекта;
- Защита от снятия компонента с производства.



#### Как с нами связаться

**Телефон:** 8 (812) 309 58 32 (многоканальный)

**Факс:** 8 (812) 320-02-42

**Электронная почта:** [org@eplast1.ru](mailto:org@eplast1.ru)

**Адрес:** 198099, г. Санкт-Петербург, ул. Калинина, дом 2, корпус 4, литера А.