

## ESTW024A0A BARRACUDA\* Series; DC-DC Converter Power Modules

### 36-75Vdc Input; 5Vdc, 24A, 120W Output



### RoHS Compliant



### Applications

- Distributed Power Architectures
- Wireless Networks
- Enterprise Networks including Power over Ethernet (PoE)
- Industrial Equipment

### Options

- Negative Remote On/Off logic (preferred)
- Over current/Over temperature/Over voltage protections (Auto-restart) (preferred)
- 1/8<sup>th</sup> Brick Heat plate for 1/8<sup>th</sup> heatsinks
- 1/4<sup>th</sup> Brick heat plate with unthreaded inserts
- Surface Mount version (-S)

### Description

The ESTW024A0A [BARRACUDA\*] Series, eighth-brick, low-height power modules are isolated dc-dc converters which provide a single, precisely regulated output voltage over an ultra-wide input voltage range of 36-75V<sub>dc</sub>. The ESTW024A0A provides 5V<sub>dc</sub> nominal output voltage rated for 24A<sub>dc</sub> output current. The module incorporates GE's vast heritage for reliability and quality, while also using the latest in technology, and component and process standardization to achieve highly competitive cost. The open frame module construction, available in both surface-mount and through-hole packaging, enable designers to develop cost and space efficient solutions. The module achieves typical full load efficiency greater than 91% at V<sub>IN</sub>=48V<sub>dc</sub>. Standard features include remote On/Off, remote sense, output voltage adjustment, overvoltage, overcurrent and overtemperature protection. An optional heat plate allows for external standard, eighth-brick or quarter-brick heat sink attachment to achieve higher output current in high temperature applications.

### Features

- Compliant to RoHS II EU "Directive 2011/65/EU (-Z versions)
- Compliant to REACH Directive (EC) No 1907/2006
- Flat and high efficiency curve
- Industry standard, DOSA compliant footprint  
58.4mm x 22.8mm x 8.9mm  
(2.30 in x 0.9 in x 0.35 in)
- Ultra wide input voltage range: 36-75 V<sub>dc</sub>
- Tightly regulated output
- Remote sense
- Output Voltage adjust: 90% to 110% of V<sub>O,nom</sub>
- Constant switching frequency
- Positive remote On/Off logic
- Output overcurrent and overvoltage protection
- Overtemperature protection
- Wide operating temperature range (-40°C to 85°C)
- Suitable for cold wall cooling using suitable Gap Pad applied directly to top side of module
- ANSI/UL#60950-1-2011 and CAN/CSA† C22.2 No. 60950-1-07, Second Edition + A1:2011 (MOD), dated March 19, 2011; and DIN EN 60950-1 (VDE‡ 0805 Teil 1):2011-01; EN 60950-1:2006 + A11:2009 + A1:2010, DIN EN 60950-1/A12 (VDE 0805-1/A12):2011-08; EN 60950-1/A12:2011-02, IEC 60950-1(ed.2);am1:2009
- CE mark meets 2006/95/EC directive§
- Meets the voltage and current requirements for ETSI 300-132-2 and complies with and licensed for Basic insulation rating per EN60950-1
- 2250 Vdc Isolation tested in compliance with IEEE 802.3<sup>¶</sup> PoE standards
- ISO\*\*9001 and ISO 14001 certified manufacturing facilities

\* Trademark of General Electric Corporation.

# UL is a registered trademark of Underwriters Laboratories, Inc.

† CSA is a registered trademark of Canadian Standards Association.

‡ VDE is a trademark of Verband Deutscher Elektrotechniker e.V.

§ This product is intended for integration into end-user equipment. All of the required procedures of end-use equipment should be followed.

¶ IEEE and 802 are registered trademarks of the Institute of Electrical and Electronics Engineers, Incorporated.

\*\* ISO is a registered trademark of the International Organization of Standards

## ESTW024A0A Series: DC-DC Converter Power Module

### 36 to 75V<sub>dc</sub> Input; 5V<sub>dc</sub>, 24A, 120W Output

#### Absolute Maximum Ratings

Stresses in excess of the absolute maximum ratings can cause permanent damage to the device. These are absolute stress ratings only, functional operation of the device is not implied at these or any other conditions in excess of those given in the operations sections of the data sheet. Exposure to absolute maximum ratings for extended periods can adversely affect the device reliability.

Parameter	Device	Symbol	Min	Max	Unit
Input Voltage					
Continuous	All	V <sub>IN</sub>	-0.3	80	V <sub>dc</sub>
Transient, operational (≤100 ms)	All	V <sub>IN,trans</sub>	-0.3	100	V <sub>dc</sub>
Operating Ambient Temperature	All	T <sub>A</sub>	-40	85	°C
Maximum Heat Plate Operating Temperature (see Thermal Considerations section)	-18H, H	T <sub>C</sub>	-40	105	°C
Storage Temperature	All	T <sub>stg</sub>	-55	125	°C
Altitude*	All			4000	m
I/O Isolation voltage (100% factory Hi-Pot tested)	All	—	—	2250	V <sub>dc</sub>

\* For higher altitude applications, contact your GE Sales Representative for alternative conditions of use.

#### Electrical Specifications

Unless otherwise indicated, specifications apply over all operating input voltage, resistive load, and temperature conditions.

Parameter	Device	Symbol	Min	Typ	Max	Unit
Operating Input Voltage	All	V <sub>IN</sub>	36	48	75	V <sub>dc</sub>
Maximum Input Current (V <sub>IN</sub> = V <sub>IN,min</sub> to V <sub>IN,max</sub> , V <sub>O</sub> = V <sub>O,set</sub> , I <sub>O</sub> = I <sub>O,max</sub> )	All	I <sub>IN</sub>		3.65	3.9	A <sub>dc</sub>
Input No Load Current (V <sub>IN</sub> = 48V, I <sub>O</sub> = 0, module enabled)	All	I <sub>IN,No load</sub>		80		mA
Input Stand-by Current (V <sub>IN</sub> = 48V, module disabled)	All	I <sub>IN,stand-by</sub>		5	11	mA
Inrush Transient	All	I <sup>2</sup> t			0.5	A <sup>2</sup> s
Input Reflected Ripple Current, peak-to-peak (5Hz to 20MHz, 1μH source impedance; V <sub>IN,min</sub> to V <sub>IN,max</sub> , I <sub>O</sub> = I <sub>O,max</sub> ; See Test configuration section)	All			30		mA <sub>p-p</sub>
Input Ripple Rejection (120Hz)	All			60		dB

#### CAUTION: This power module is not internally fused. An input line fuse must always be used.

This power module can be used in a wide variety of applications, ranging from simple standalone operation to an integrated part of sophisticated power architectures. To preserve maximum flexibility, internal fusing is not included, however, to achieve maximum safety and system protection, always use an input line fuse. The safety agencies require a fast-acting fuse with a maximum rating of 15 A (see Safety Considerations section). Based on the information provided in this data sheet on inrush energy and maximum dc input current, the same type of fuse with a lower rating can be used. Refer to the fuse manufacturer's data sheet for further information.

## ESTW024A0A Series: DC-DC Converter Power Module

### 36 to 75V<sub>dc</sub> Input; 5V<sub>dc</sub>, 24A, 120W Output

#### Electrical Specifications (continued)

Unless otherwise indicated, specifications apply at V<sub>IN</sub> = 48V<sub>dc</sub>, resistive load, and T<sub>A</sub> = 25°C conditions.

Parameter	Device	Symbol	Min	Typ	Max	Unit
Nominal Output Voltage Set-point V <sub>IN</sub> = 48V I <sub>O</sub> =I <sub>O,max</sub> , T <sub>A</sub> =25°C	All	V <sub>O,set</sub>	4.93	5	5.07	V <sub>dc</sub>
Output Voltage (Over all operating input voltage, resistive load, and temperature conditions until end of life)	All	V <sub>O</sub>	-3.0	—	+3.0	% V <sub>O,set</sub>
Adjustment Range (*V <sub>in</sub> > 20V) Selected by external resistor	All	V <sub>O,adj</sub>	-10		+10*	% V <sub>O,set</sub>
Output Regulation Line (V <sub>IN</sub> =V <sub>IN,min</sub> to V <sub>IN,max</sub> ) Load (I <sub>O</sub> =I <sub>O,min</sub> to I <sub>O,max</sub> ) Temperature (T <sub>ref</sub> =T <sub>A,min</sub> to T <sub>A,max</sub> )	All All All		— — —	— — —	±0.2 ±0.2 ±1.5	% V <sub>O,set</sub> % V <sub>O,set</sub> % V <sub>O,set</sub>
Output Ripple and Noise on nominal output Measured with 10uF Tantalum  1uF ceramic (V <sub>IN</sub> =48, I <sub>O</sub> =80% I <sub>O,max</sub> , T <sub>A</sub> =25) RMS (5Hz to 20MHz bandwidth) Peak-to-Peak (5Hz to 20MHz bandwidth)	All All			30 100		mV <sub>rms</sub> mV <sub>pk-pk</sub>
External Capacitance	All	C <sub>O,max</sub>	0	—	10,000	μF
Output Current	All	I <sub>O</sub>	0		24	A <sub>dc</sub>
Output Current Limit Inception (Hiccup Mode ) (V <sub>O</sub> = 90% of V <sub>O,set</sub> )	5	I <sub>O,lim</sub>	26.5	29		A <sub>dc</sub>
Output Short-Circuit Current (V <sub>O</sub> ≤250mV) ( Hiccup Mode )	All	I <sub>O,s/c</sub>		1.2		A <sub>rms</sub>
Efficiency V <sub>IN</sub> =48V, T <sub>A</sub> =25°C, I <sub>O</sub> =24A, V <sub>O</sub> = 5V	All	η		91.5		%
Switching Frequency	All	f <sub>sw</sub>		280		kHz
Dynamic Load Response (dI <sub>O</sub> /dt=0.1A/μs; V <sub>IN</sub> = 48V; T <sub>A</sub> =25°C; C <sub>O</sub> >100μF) Load Change from I <sub>O</sub> = 50% to 75% or 25% to 50% of I <sub>O,max</sub> Peak Deviation Settling Time (V <sub>O</sub> <10% peak deviation)	All All	V <sub>pk</sub> t <sub>s</sub>	— —	3 800	— —	% V <sub>O,set</sub> μs

#### Isolation Specifications

Parameter	Device	Symbol	Min	Typ	Max	Unit
Isolation Capacitance	All	C <sub>iso</sub>	—	1000	—	pF
Isolation Resistance	All	R <sub>iso</sub>	10	—	—	MΩ
I/O Isolation Voltage (100% factory Hi-pot tested)	All	All	—	—	2250	V <sub>dc</sub>

#### General Specifications

Parameter	Device	Symbol	Min	Typ	Max	Unit
Calculated Reliability based upon Telcordia SR-332 Issue 2: Method I Case 3 (I <sub>O</sub> =80%I <sub>O,max</sub> , T <sub>A</sub> =40°C, airflow = 200 lfm, 90% confidence)	All	FIT		112.7		10 <sup>9</sup> /Hour s
	All	MTBF		8,869,389		Hours
Weight (Open Frame)	All			23(0.8)		g (oz.)
Weight (with Heatplate)	All			37(1.3)		g (oz.)

## ESTW024A0A Series: DC-DC Converter Power Module

### 36 to 75V<sub>dc</sub> Input; 5V<sub>dc</sub>, 24A, 120W Output

#### Feature Specifications

Unless otherwise indicated, specifications apply over all operating input voltage, resistive load, and temperature conditions. See Feature Descriptions for additional information.

Parameter	Device	Symbol	Min	Typ	Max	Unit
Remote On/Off Signal Interface (V <sub>IN</sub> =V <sub>IN,min</sub> to V <sub>IN,max</sub> ; open collector or equivalent, Signal referenced to V <sub>IN</sub> terminal) Negative Logic: device code suffix "1" Logic Low = module On, Logic High = module Off Positive Logic: No device code suffix required Logic Low = module Off, Logic High = module On						
Logic Low - Remote On/Off Current	All	I <sub>on/off</sub>	—		0.15	mA
Logic Low - On/Off Voltage	All	V <sub>on/off</sub>	-0.7	—	0.6	V <sub>dc</sub>
Logic High Voltage - (Typ = Open Collector)	All	V <sub>on/off</sub>	2.5	5	6.7	V <sub>dc</sub>
Logic High maximum allowable leakage current	All	I <sub>on/off</sub>	—	—	20	μA
Turn-On Delay and Rise Times (I <sub>o</sub> =I <sub>o,max</sub> , V <sub>IN</sub> =V <sub>IN,nom</sub> , T <sub>A</sub> = 25°C)						
Case 1: Input power is applied for at least 1 second, and then the On/Off input is set from OFF to ON (T <sub>delay</sub> = on/off pin transition until V <sub>o</sub> = 10% of V <sub>o,set</sub> )	All	T <sub>delay</sub>	—	35	—	msec
Case 2: On/Off input is set to Logic Low (Module ON) and then input power is applied (T <sub>delay</sub> from instant at which V <sub>IN</sub> = V <sub>IN,min</sub> until V <sub>o</sub> =10% of V <sub>o,set</sub> )	All	T <sub>delay</sub>	—	35	-	msec
Output voltage Rise time (time for V <sub>o</sub> to rise from 10% of V <sub>o,set</sub> to 90% of V <sub>o,set</sub> )	All	T <sub>rise</sub>	—	20		msec
Output voltage overshoot - Startup I <sub>o</sub> = I <sub>o,max</sub> ; V <sub>IN</sub> =V <sub>IN,min</sub> to V <sub>IN,max</sub> , T <sub>A</sub> = 25 °C	All			—	3	% V <sub>o,set</sub>
Remote Sense Range	All	V <sub>SENSE</sub>			10	% V <sub>o,set</sub>
Output Voltage Adjustment Range	All		90		110	% V <sub>o,set</sub>
Output Overvoltage Protection <sup>1</sup>	All	V <sub>o,limit</sub>	5.9	—	7.0	V <sub>dc</sub>
Overtemperature Protection - Hiccup Auto Restart	Open frame Heat Plate	T <sub>ref</sub>		135		°C
		T <sub>ref</sub>		120		°C
Input Undervoltage Lockout	All	V <sub>UVLO</sub>				
Turn-on Threshold			—	35	36	V <sub>dc</sub>
Turn-off Threshold			31	32	32	V <sub>dc</sub>
Hysteresis			2	3		V <sub>dc</sub>
Input Overvoltage Lockout	All	V <sub>OVLO</sub>				
Turn-on Threshold			76	79	—	V <sub>dc</sub>
Turn-off Threshold			—	81	83	V <sub>dc</sub>
Hysteresis			1	2	—	V <sub>dc</sub>

<sup>1</sup> - Module complies with 7V<sub>max</sub> with Trim Pin short to Sense+, with and without external cap. For Open Loop condition max OVP was 7.3V with min. 220μF external cap

# ESTW024A0A Series: DC-DC Converter Power Module

36 to 75V<sub>dc</sub> Input; 5V<sub>dc</sub>, 24A, 120W Output

## Characteristic Curves

The following figures provide typical characteristics for the ESTW024A0A (5V, 24A) at 25 °C. The figures are identical for either positive or negative remote On/Off logic.

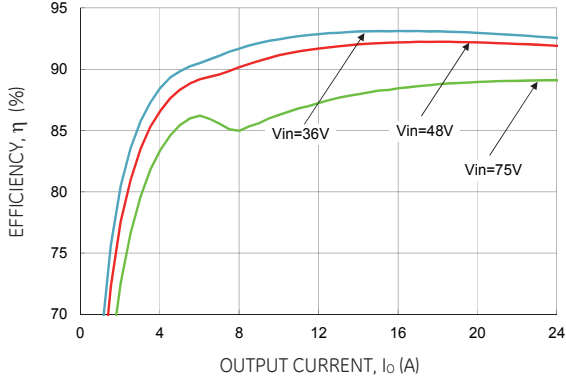

Figure 1. Converter Efficiency versus Output Current.

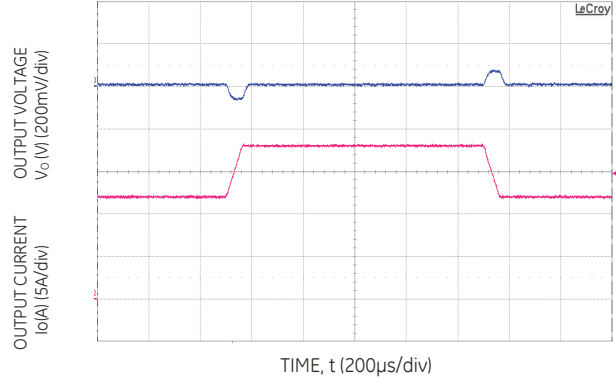

Figure 4. Transient Response to 0.1A/μs Dynamic Load Change from 50% to 75% to 50% of full load, Vin=48V.

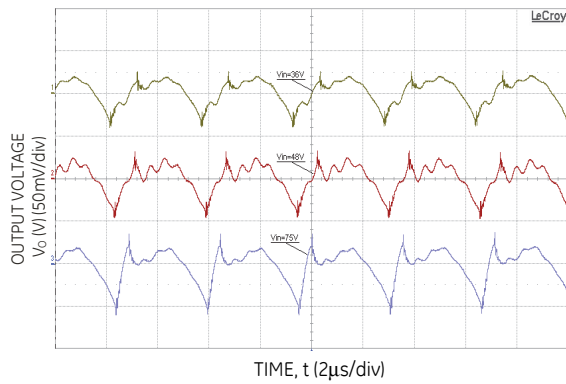

Figure 2. Typical output ripple and noise ( $I_o = I_{o,max}$ ).

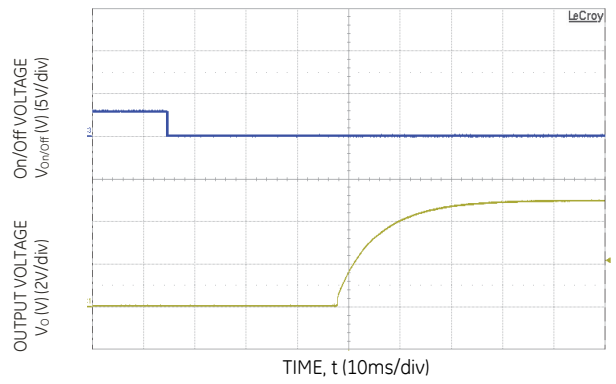

Figure 5. Typical Start-up Using Remote On/Off, negative logic version shown ( $V_{IN} = 48V$ ,  $I_o = I_{o,max}$ ).

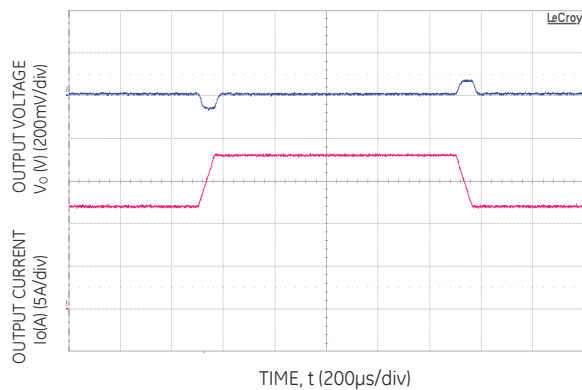

Figure 3. Transient Response to 0.1A/μs Dynamic Load Change from 50% to 75% to 50% of full load, Vin=48V

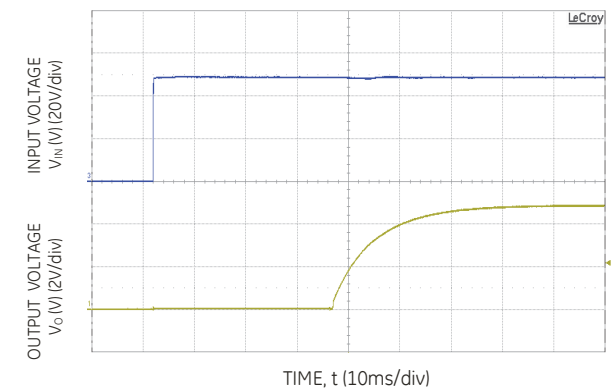
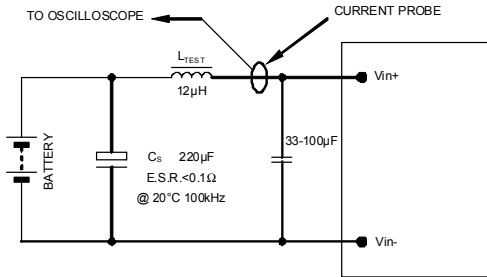

Figure 6. Typical Start-up Using Input Voltage ( $V_{IN} = 48V$ ,  $I_o = I_{o,max}$ ).

# ESTW024A0A Series: DC-DC Converter Power Module

36 to 75V<sub>dc</sub> Input; 5V<sub>dc</sub>, 24A, 120W Output

## Test Configurations



NOTE: Measure input reflected ripple current with a simulated source inductance ( $L_{TEST}$ ) of 12µH. Capacitor  $C_S$  offsets possible battery impedance. Measure current as shown above.

Figure 7. Input Reflected Ripple Current Test Setup.

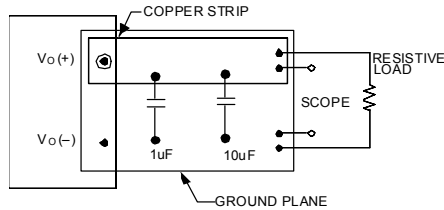

NOTE: All voltage measurements to be taken at the module terminals, as shown above. If sockets are used then Kelvin connections are required at the module terminals to avoid measurement errors due to socket contact resistance.

Figure 8. Output Ripple and Noise Test Setup.

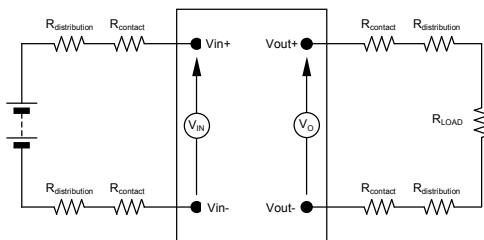

NOTE: All voltage measurements to be taken at the module terminals, as shown above. If sockets are used then Kelvin connections are required at the module terminals to avoid measurement errors due to socket contact resistance.

Figure 9. Output Voltage and Efficiency Test Setup.

$$\text{Efficiency } \eta = \frac{V_O \cdot I_O}{V_{IN} \cdot I_{IN}} \times 100 \%$$

## Design Considerations

### Input Filtering

The power module should be connected to a low ac-impedance source. Highly inductive source impedance can affect the stability of the power module. For the test configuration in Figure 7 a 100µF electrolytic capacitor (ESR<0.7Ω at 100kHz), mounted close to the power module helps ensure the stability of the unit. Consult the factory for further application guidelines.

### Safety Considerations

For safety-agency approval of the system in which the power module is used, the power module must be installed in compliance with the spacing and separation requirements of the end-use safety agency standard, i.e. UL60950-1, CSA C22.2 No.60950-1, and VDE0805-1(IEC60950-1).

If the input source is non-SELV (ELV or a hazardous voltage greater than 60 Vdc and less than or equal to 75Vdc), for the module's output to be considered as meeting the requirements for safety extra-low voltage (SELV), all of the following must be true:

- The input source is to be provided with reinforced insulation from any other hazardous voltages, including the ac mains.
- One  $V_{IN}$  pin and one  $V_{OUT}$  pin are to be grounded, or both the input and output pins are to be kept floating.
- The input pins of the module are not operator accessible.
- Another SELV reliability test is conducted on the whole system (combination of supply source and subject module), as required by the safety agencies, to verify that under a single fault, hazardous voltages do not appear at the module's output.

**Note:** Do not ground either of the input pins of the module without grounding one of the output pins. This may allow a non-SELV voltage to appear between the output pins and ground.

The power module has extra-low voltage (ELV) outputs when all inputs are ELV.

All flammable materials used in the manufacturing of these modules are rated 94V-0, or tested to the UL60950 A.2 for reduced thickness.

For input voltages exceeding -60 Vdc but less than or equal to -75 Vdc, these converters have been evaluated to the applicable requirements of BASIC INSULATION between secondary DC MAINS DISTRIBUTION input (classified as TNV-2 in Europe) and unearthed SELV outputs.

The input to these units is to be provided with a maximum 15 A fast-acting fuse in the ungrounded lead.

## ESTW024A0A Series: DC-DC Converter Power Module

36 to 75V<sub>dc</sub> Input; 5V<sub>dc</sub>, 24A, 120W Output

### Feature Descriptions

#### Remote On/Off

Two remote on/off options are available. Positive logic turns the module on during a logic high voltage on the ON/OFF pin, and off during a logic low. Negative logic remote On/Off, device code suffix "1", turns the module off during a logic high and on during a logic low.

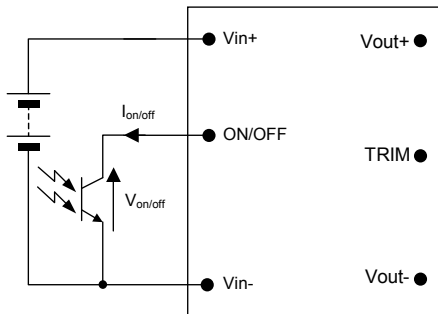

Figure 10. Remote On/Off Implementation.

To turn the power module on and off, the user must supply a switch (open collector or equivalent) to control the voltage ( $V_{on/off}$ ) between the ON/OFF terminal and the  $V_{IN(-)}$  terminal (see Figure 10). Logic low is  $0V \leq V_{on/off} \leq 0.6V$ . The maximum  $I_{on/off}$  during a logic low is 0.15mA; the switch should maintain a logic low level whilst sinking this current.

During a logic high, the typical maximum  $V_{on/off}$  generated by the module is 5V, and the maximum allowable leakage current at  $V_{on/off} = 5V$  is 1 $\mu$ A.

If not using the remote on/off feature:

For positive logic, leave the ON/OFF pin open.

For negative logic, short the ON/OFF pin to  $V_{IN(-)}$ .

#### Remote Sense

Remote sense minimizes the effects of distribution losses by regulating the voltage at the remote-sense connections (See Figure 11). The voltage between the remote-sense pins and the output terminals must not exceed the output voltage sense range given in the Feature Specifications table:

$$[V_{O(+)} - V_{O(-)}] - [SENSE(+)-SENSE(-)] \leq 0.5V$$

Although the output voltage can be increased by both the remote sense and by the trim, the maximum increase for the output voltage is not the sum of both. The maximum increase is the larger of either the remote sense or the trim.

The amount of power delivered by the module is defined as the voltage at the output terminals multiplied by the output current. When using remote sense and trim, the output voltage of the module can be increased, which at the same output current would increase the power output of the module. Care should be taken to ensure that the maximum output power of the module remains at or below the maximum rated power (Maximum rated power =  $V_{o,set} \times I_{o,max}$ ).

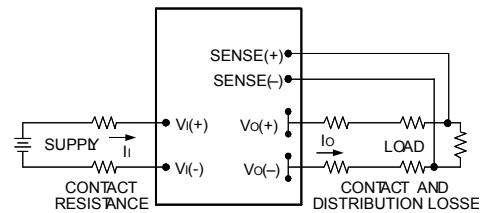

Figure 11. Circuit Configuration for remote sense .

#### Input Undervoltage Lockout

At input voltages below the input undervoltage lockout limit, the module operation is disabled. The module will only begin to operate once the input voltage is raised above the undervoltage lockout turn-on threshold,  $V_{UV/ON}$ .

Once operating, the module will continue to operate until the input voltage is taken below the undervoltage turn-off threshold,  $V_{UV/OFF}$ .

#### Overtemperature Protection

To provide protection under certain fault conditions, the unit is equipped with a thermal shutdown circuit. The unit will shutdown if the thermal reference point,  $T_{ref}$ , exceeds 120° and 124 °C (Figure 13, typical) or 105 °C (Figure 14, typical), but the thermal shutdown is not intended as a guarantee that the unit will survive temperatures beyond its rating. The module will automatically restart upon cool-down to a safe temperature.

#### Output Overvoltage Protection

The output over voltage protection scheme of the modules has an independent over voltage loop to prevent single point of failure. This protection feature latches in the event of over voltage across the output. Cycling the on/off pin or input voltage resets the latching protection feature. If the auto-restart option (4) is ordered, the module will automatically restart upon an internally programmed time elapsing.

#### Overcurrent Protection

To provide protection in a fault (output overload) condition, the unit is equipped with internal current-limiting circuitry and can endure current limiting continuously. At the point of current-limit inception, the unit enters hiccup mode. If the unit is not configured with auto-restart, then it will latch off following the over current condition. The module can be restarted by cycling the dc input power for at least one second or by toggling the remote on/off signal for at least one second.



## ESTW024A0A Series: DC-DC Converter Power Module

### 36 to 75V<sub>dc</sub> Input; 5V<sub>dc</sub>, 24A, 120W Output

#### Feature Descriptions (continued)

If the unit is configured with the auto-restart option (4), it will remain in the hiccup mode as long as the overcurrent condition exists; it operates normally, once the output current is brought back into its specified range. The average output current during hiccup is 10% I<sub>o,max</sub>.

#### Output Voltage Programming

Trimming allows the output voltage set point to be increased or decreased from the default value; this is accomplished by connecting an external resistor between the TRIM pin and either the V<sub>o</sub>(+) pin or the V<sub>o</sub>(-) pin.

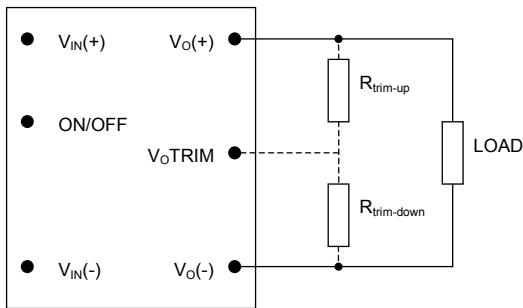

**Figure 12. Circuit Configuration to Trim Output Voltage.**

Connecting an external resistor (R<sub>trim-down</sub>) between the TRIM pin and the V<sub>o</sub>(-) (or Sense(-)) pin decreases the output voltage set point. To maintain set point accuracy, the trim resistor tolerance should be ±1.0%.

The following equation determines the required external resistor value to obtain a percentage output voltage change of Δ%:

$$R_{trim-down} = \left[ \frac{511}{\Delta\%} - 10.22 \right] \text{K}\Omega$$

$$\text{Where } \Delta\% = \left( \frac{5.0V - V_{desired}}{5.0V} \right) \times 100$$

For example, to trim-down the output voltage of the module by 6% to 4.7V, R<sub>trim-down</sub> is calculated as follows:

$$\Delta\% = 6$$

$$R_{trim-down} = \left[ \frac{511}{6} - 10.22 \right] \text{K}\Omega$$

$$R_{trim-down} = 74.9 \text{K}\Omega$$

Connecting an external resistor (R<sub>trim-up</sub>) between the TRIM pin and the V<sub>o</sub>(+) (or Sense (+)) pin increases the output voltage set point. The following equation determines the required external resistor value to obtain a percentage output voltage change of Δ%:

$$R_{trim-up} = \left[ \frac{5.11 \times 5.0 \times (100 + \Delta\%)}{1.225 \times \Delta\%} - \frac{511}{\Delta\%} - 10.22 \right] \text{K}\Omega$$

$$\text{Where } \Delta\% = \left( \frac{V_{desired} - 5.0}{5.0} \right) \times 100$$

For example, to trim-up the output voltage of the module by 4% to 5.2V, R<sub>trim-up</sub> is calculated as follows:

$$\Delta\% = 4$$

$$R_{trim-up} = \left[ \frac{5.11 \times 5.0 \times (100 + 4)}{1.225 \times 4} - \frac{511}{4} - 10.22 \right] \text{K}\Omega$$

$$R_{trim-up} = 404.3 \text{K}\Omega$$

The voltage between the V<sub>o</sub>(+) and V<sub>o</sub>(-) terminals must not exceed the minimum output overvoltage protection value shown in the Feature Specifications table. This limit includes any increase in voltage due to remote-sense compensation and output voltage set-point adjustment trim.

Although the output voltage can be increased by both the remote sense and by the trim, the maximum increase for the output voltage is not the sum of both. The maximum increase is the larger of either the remote sense or the trim. The amount of power delivered by the module is defined as the voltage at the output terminals multiplied by the output current. When using remote sense and trim, the output voltage of the module can be increased, which at the same output current would increase the power output of the module. Care should be taken to ensure that the maximum output power of the module remains at or below the maximum rated power (Maximum rated power = V<sub>o,set</sub> × I<sub>o,max</sub>).

#### Thermal Considerations

The power modules operate in a variety of thermal environments; however, sufficient cooling should be provided to help ensure reliable operation.

Considerations include ambient temperature, airflow, module power dissipation, and the need for increased reliability. A reduction in the operating temperature of the module will result in an increase in reliability.

The thermal data presented here is based on physical measurements taken in a wind tunnel, using automated thermo-couple instrumentation to monitor key component temperatures: FETs, diodes, control ICs, magnetic cores, ceramic capacitors, opto-isolators, and module pwb conductors, while controlling the ambient airflow rate and temperature. For a given airflow and ambient temperature, the module output power is increased, until one (or more) of the components reaches its maximum derated operating temperature, as defined in IPC-9592. This procedure is then repeated for a different airflow or ambient temperature until a family of module output derating curves is obtained.



ESTW024A0A Series: DC-DC Converter Power Module  
 36 to 75V<sub>dc</sub> Input; 5V<sub>dc</sub>, 24A, 120W Output

Thermal Considerations (continued)

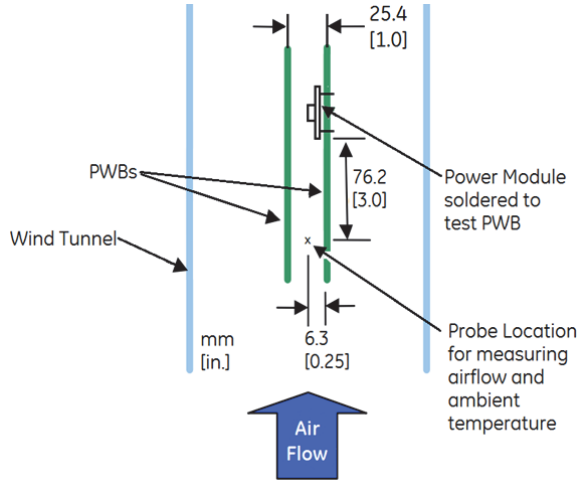

The thermal reference points,  $T_{ref}$ , used in the specifications for open frame modules is shown in Figure 13. For reliable operation these temperatures should not exceed 120°C and 124°C.

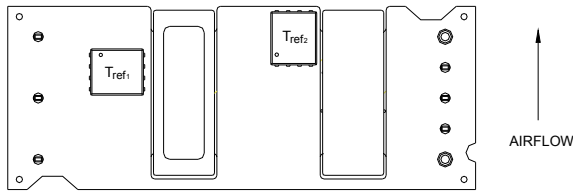

Figure 13.  $T_{ref}$  Temperature Measurement Locations for Open Frame Module.

The thermal reference point,  $T_{ref}$ , used in the specifications for modules with heatplate is shown in Figure 14. For reliable operation this temperature should not exceed 98°C.

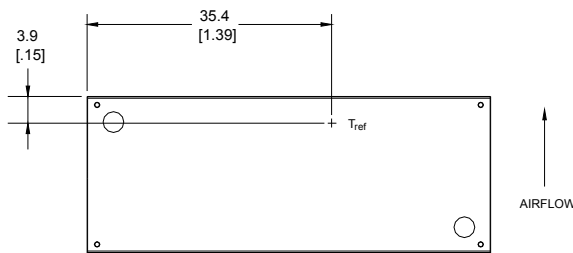

Figure 14.  $T_{ref}$  Temperature Measurement Location for Module with Heatplate.

Heat Transfer via Convection

Increased airflow over the module enhances the heat transfer via convection. Derating curves showing the maximum output current that can be delivered by each module versus local ambient temperature ( $T_A$ )

for natural convection and up to 3m/s (600 ft./min) forced airflow are shown in Figures 15 - 21.

Please refer to the Application Note “Thermal Characterization Process For Open-Frame Board-Mounted Power Modules” for a detailed discussion of thermal aspects including maximum device temperatures.

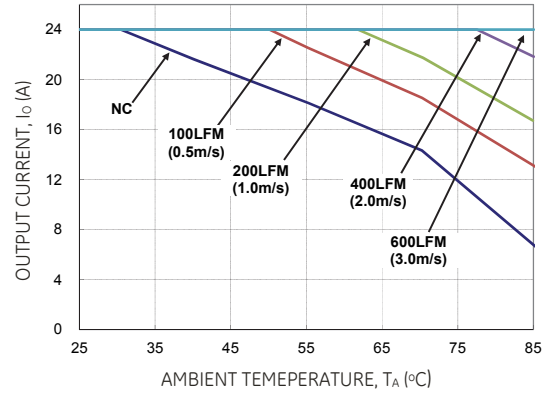

Figure 15. Output Current Derating for the Open Frame Module; Airflow in the Transverse Direction from  $V_{out(-)}$  to  $V_{out(+)}$ ;  $V_{IN}=48V$ ,  $V_O=5V$ .

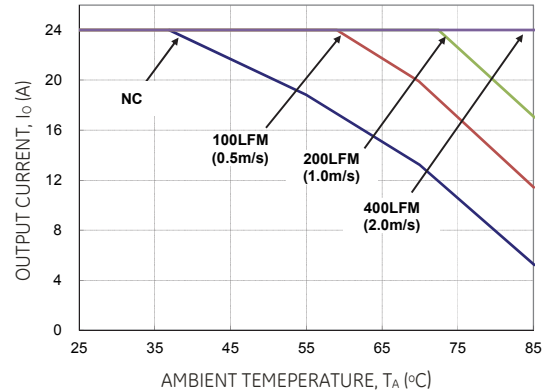

Figure 16. Output Current Derating for the Module with Heatplate; Airflow in the Transverse Direction from  $V_{out(-)}$  to  $V_{out(+)}$ ;  $V_{IN}=48V$ ,  $V_O=5V$ .

ESTW024A0A Series: DC-DC Converter Power Module  
 36 to 75V<sub>dc</sub> Input; 5V<sub>dc</sub>, 24A, 120W Output

Thermal Considerations (continued)

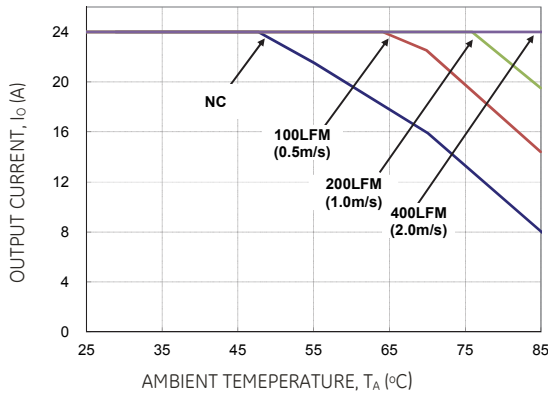

Figure 17. Output Current Derating for the Module with -18H Heatplate; Airflow in the Transverse Direction from V<sub>out</sub>(-) to V<sub>out</sub>(+); V<sub>IN</sub> = 48V, V<sub>O</sub> = 5V

Heat Transfer via Conduction

The module can also be used in a sealed environment with cooling via conduction from the module's top surface through a gap pad material to a cold wall, as shown in Figure 18. This capability is achieved by insuring the top side component skyline profile achieves no more than 1mm height difference between the tallest and the shortest power train part that benefits from contact with the gap pad material. The output current derating versus cold wall temperature, when using a gap pad such as Bergquist GP2500S20, is shown in Figure 19.

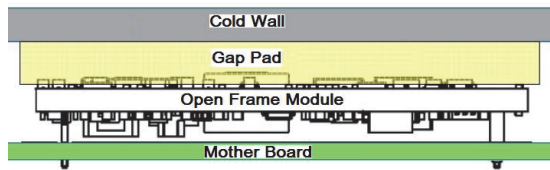

Figure 18. Cold Wall Mounting

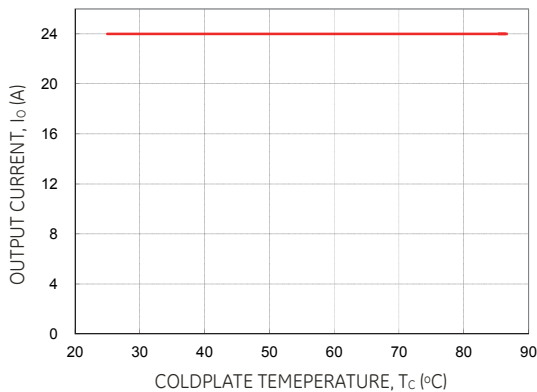

Figure 19. Derated Output Current versus Cold Wall Temperature with local ambient temperature around module at 85C; V<sub>IN</sub> = 48V.

## ESTW024A0A Series: DC-DC Converter Power Module

36 to 75V<sub>dc</sub> Input; 5V<sub>dc</sub>, 24A, 120W Output

### Through-Hole Soldering Information

#### Lead-Free Soldering

The ESTW024A0A xx RoHS-compliant through-hole products use SAC (Sn/Ag/Cu) Pb-free solder and RoHS-compliant components. They are designed to be processed through single or dual wave soldering machines. The pins have a RoHS-compliant finish that is compatible with both Pb and Pb-free wave soldering processes. A maximum preheat rate of 3°C/s is suggested. The wave preheat process should be such that the temperature of the power module board is kept below 210°C. For Pb solder, the recommended pot temperature is 260°C, while the Pb-free solder pot is 270°C max.

#### Paste-in-Hole Soldering

The ESTW024A0A xx module is compatible with reflow paste-in-hole soldering processes shown in Figures 25-27. Since the ESTW024A0A xxZ module is not packaged per J-STD-033 Rev.A, the module must be baked prior to the paste-in-hole reflow process. Please contact your GE Sales Representative for further information.

### Surface Mount Information

#### MSL Rating

The ESTW024A0A -SZ module has a MSL rating of 2a.

#### Storage and Handling

The recommended storage environment and handling procedures for moisture-sensitive surface mount packages is detailed in J-STD-033 Rev. A (Handling,

Packing, Shipping and Use of Moisture/Reflow Sensitive Surface Mount Devices). Moisture barrier bags (MBB) with desiccant are provided for the ESTW024A0Axx-SZ modules. These sealed packages should not be broken until time of use. Once the original package is broken, the floor life of the product at conditions of  $\leq 30^{\circ}\text{C}$  and 60% relative humidity varies according to the MSL rating (see J-STD-033A). The shelf life for dry packed SMT packages is a minimum of 12 months from the bag seal date, when stored at the following conditions:  $< 40^{\circ}\text{C}$ ,  $< 90\%$  relative humidity.

#### Pick and Place

The ESTW024A0A modules use an open frame construction and are designed for a fully automated assembly process. The modules are fitted with a label designed to provide a large surface area for pick and place operations. The label meets all the requirements for surface mount processing, as well as safety standards, and is able to withstand reflow temperatures of up to 300°C. The label also carries product information such as product code, serial number and the location of manufacture.

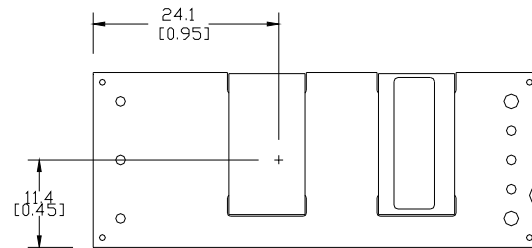

Figure 20. Pick and Place Location.

#### Nozzle Recommendations

The module weight has been kept to a minimum by using open frame construction. Even so, these modules have a relatively large mass when compared to conventional SMT components. Variables such as nozzle size, tip style, vacuum pressure and placement speed should be considered to optimize this process. The minimum recommended nozzle diameter for reliable operation is 6mm. The maximum nozzle outer diameter, which will safely fit within the allowable component spacing, is 9 mm.

Oblong or oval nozzles up to 11 x 9 mm may also be used within the space available.

#### Tin Lead Soldering

The ESTW024A0A power modules are lead free modules and can be soldered either in a lead-free solder process or in a conventional Tin/Lead (Sn/Pb) process. It is recommended that the customer review data sheets in order to customize the solder reflow profile for each application board assembly. The following instructions must be observed when soldering these units. Failure to observe these instructions may result in the failure of or cause damage to the modules, and can adversely affect long-term reliability.

In a conventional Tin/Lead (Sn/Pb) solder process peak reflow temperatures are limited to less than 235oC. Typically, the eutectic solder melts at 183oC, wets the land, and subsequently wicks the device connection. Sufficient

time must be allowed to fuse the plating on the connection to ensure a reliable solder joint. There are several types of SMT reflow technologies currently used in the industry. These surface mount power modules can be reliably soldered using natural forced convection, IR (radiant infrared), or a combination of convection/IR. For reliable soldering the solder reflow profile should be established by accurately measuring the modules CP connector temperatures.

#### Lead Free Soldering

The -Z version of the ESTW024A0A modules are lead-free (Pb-free) and RoHS compliant and are both forward and backward compatible in a Pb-free and a SnPb soldering process. Failure to observe the instructions below may result in the failure of or cause damage to the modules and can adversely affect long-term reliability.

ESTW024A0A Series: DC-DC Converter Power Module  
 36 to 75V<sub>dc</sub> Input; 5V<sub>dc</sub>, 24A, 120W Output

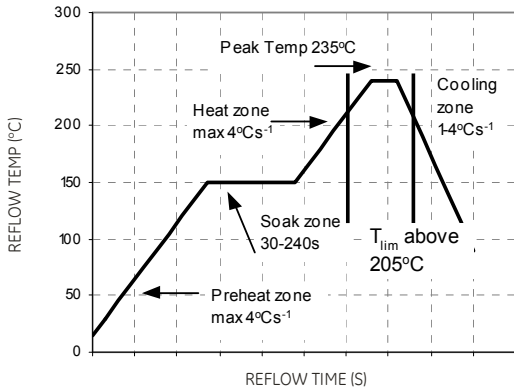

Figure 21. Reflow Profile for Tin/Lead (Sn/Pb) process.

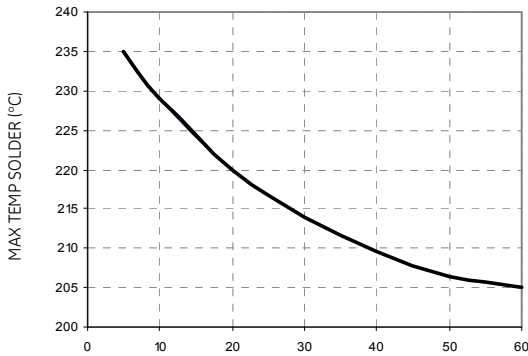

Figure 22. Time Limit Curve Above 205°C for Tin/Lead (Sn/Pb) process

**Pb-free Reflow Profile**

Power Systems will comply with J-STD-015 Rev. D (Moisture/Reflow Sensitivity Classification for Nonhermetic Solid State Surface Mount Devices) for both Pb-free solder profiles and MSL classification procedures. This standard

provides a recommended forced-air-convection reflow profile based on the volume and thickness of the package (table 4-2). The suggested Pb-free solder paste is Sn/Ag/Cu (SAC). The recommended linear reflow profile using Sn/Ag/Cu solder is shown in Figure 23.

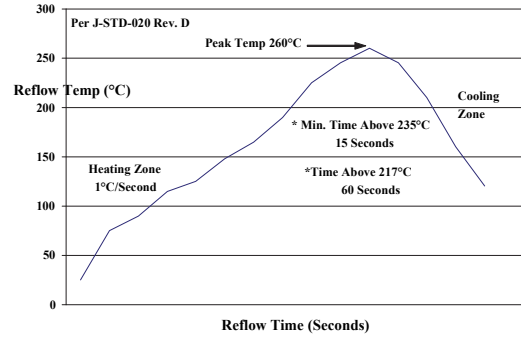

Figure 23. Recommended linear reflow profile using Sn/Ag/Cu solder.

**Post Solder Cleaning and Drying Considerations**

Post solder cleaning is usually the final circuit-board assembly process prior to electrical board testing. The result of inadequate cleaning and drying can affect both the reliability of a power module and the testability of the finished circuit-board assembly. For guidance on appropriate soldering, cleaning and drying procedures, refer to *GE Board Mounted Power Modules: Soldering and Cleaning Application Note (AN04-001)*.

# ESTW024A0A Series: DC-DC Converter Power Module

36 to 75V<sub>dc</sub> Input; 5V<sub>dc</sub>, 24A, 120W Output

## EMC Considerations

The circuit and plots in Figure 24 shows a suggested configuration to meet the conducted emission limits of EN55022 Class B.

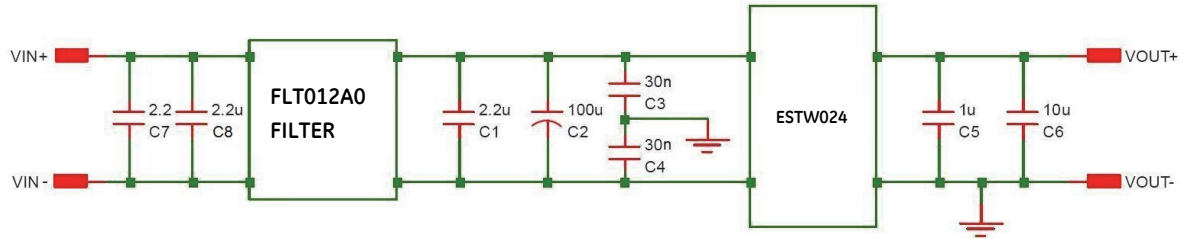
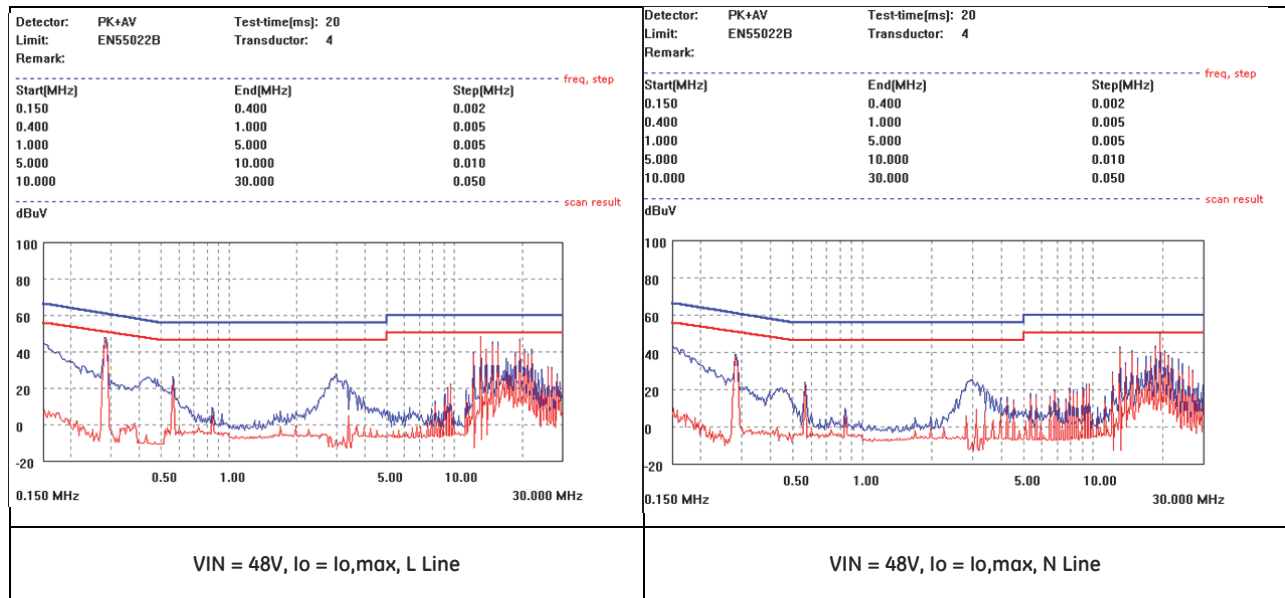

Figure 24. EMC Considerations

For further information on designing for EMC compliance, please refer to the FLT012A0 data sheet (DS05-028).



# ESTW024A0A Series: DC-DC Converter Power Module

36 to 75V<sub>dc</sub> Input; 5V<sub>dc</sub>, 24A, 120W Output

## Mechanical Outline for Through-Hole Module

Dimensions are in millimeters and [inches].

Tolerances: x.x mm ± 0.5 mm [x.xx in. ± 0.02 in.] (Unless otherwise indicated)

x.xx mm ± 0.25 mm [x.xxx in ± 0.010 in.]

\*Top side label includes GE name, product designation and date code.

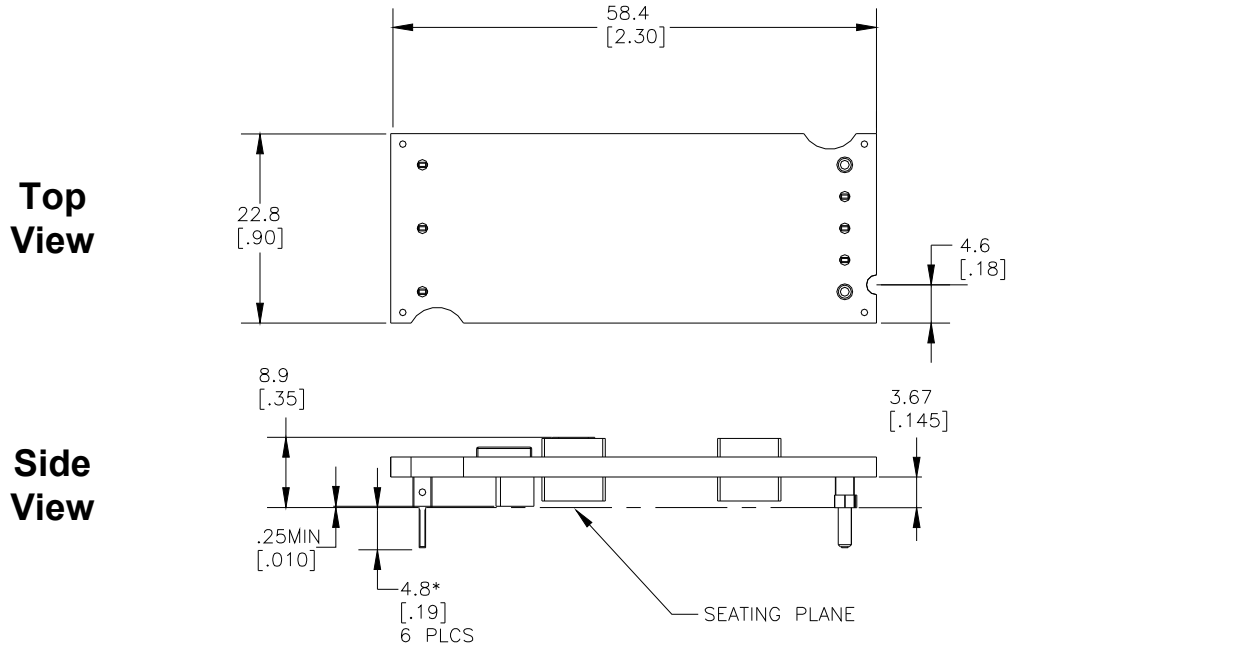

\*For optional pin lengths, see Table 2, Device Coding Scheme and Options

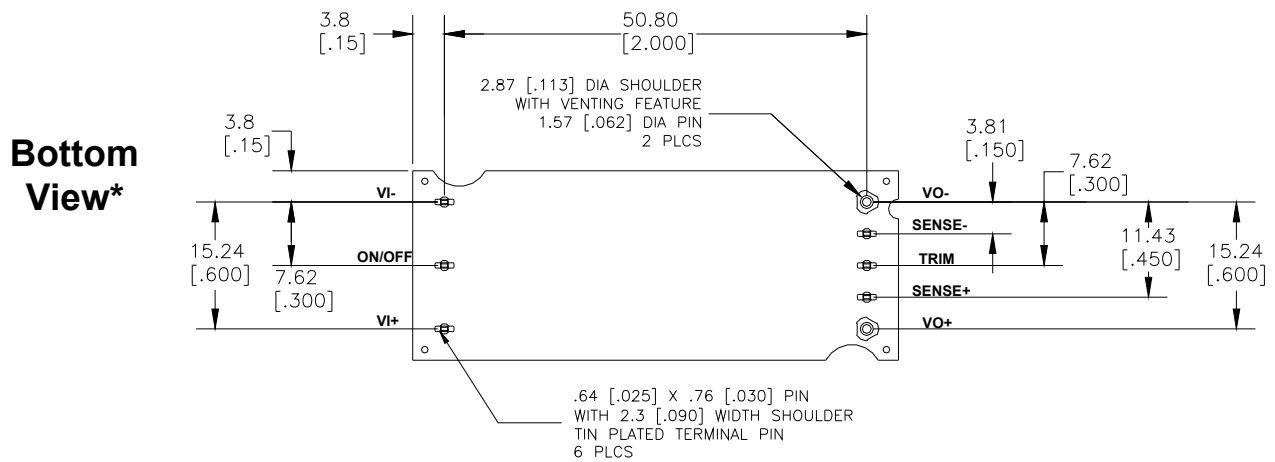

# ESTW024A0A Series: DC-DC Converter Power Module

36 to 75V<sub>dc</sub> Input; 5V<sub>dc</sub>, 24A, 120W Output

## Mechanical Outline for Surface Mount Module (-S Option)

Dimensions are in millimeters and [inches].

Tolerances: x.x mm ± 0.5 mm [x.xx in. ± 0.02 in.] (Unless otherwise indicated)

x.xx mm ± 0.25 mm [x.xxx in ± 0.010 in.]

\* Top side label includes GE name, product designation and date code.

**Top View**

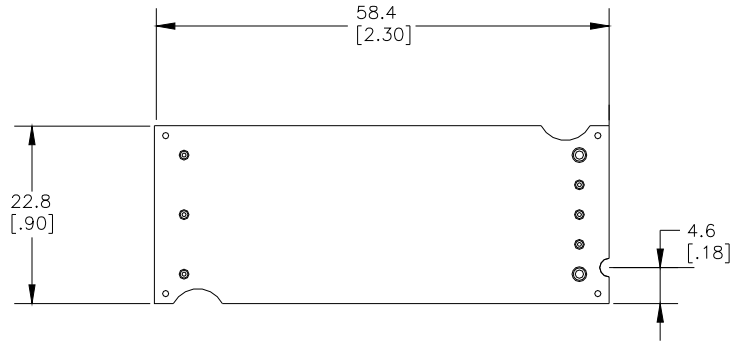

**Side View**

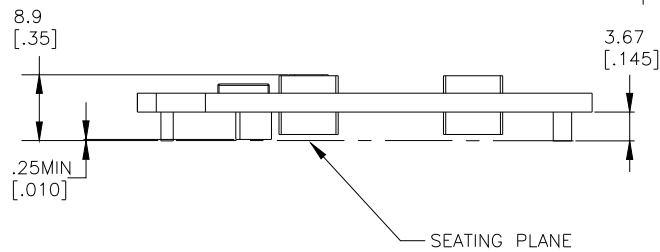

**Bottom View\***

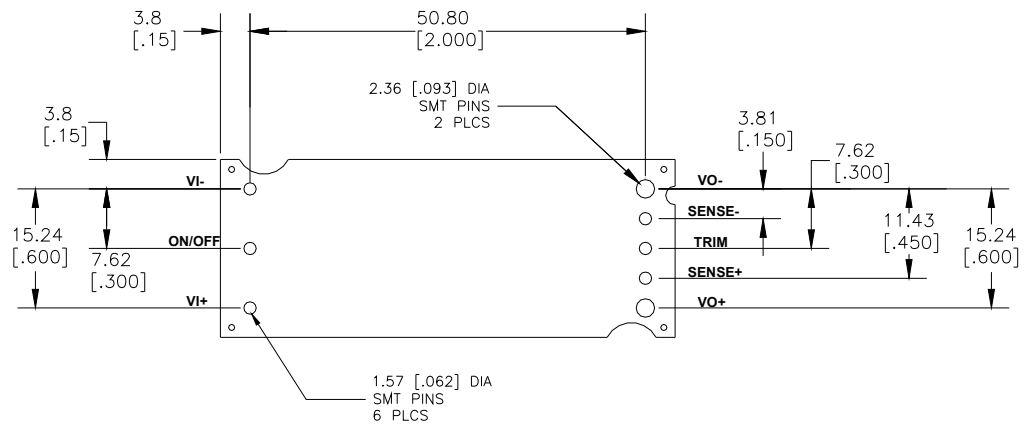



# ESTW024A0A Series: DC-DC Converter Power Module

36 to 75V<sub>dc</sub> Input; 5V<sub>dc</sub>, 24A, 120W Output

## Mechanical Outline for Through-Hole Module with Heat Plate (-H Option)

Dimensions are in millimeters and [inches].

Tolerances: x.x mm ± 0.5 mm [x.xx in. ± 0.02 in.] (Unless otherwise indicated)

x.xx mm ± 0.25 mm [x.xxx in. ± 0.010 in.]

**Top View**

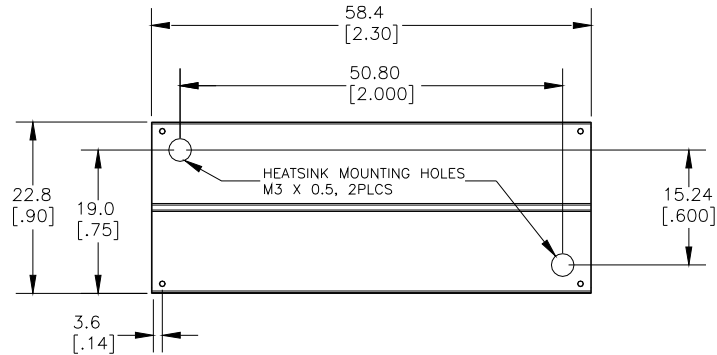

**Side View**

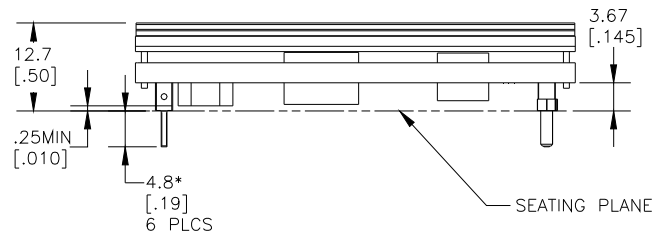

\*For optional pin lengths, see Table 2, Device Coding Scheme and Options

**Bottom View\***

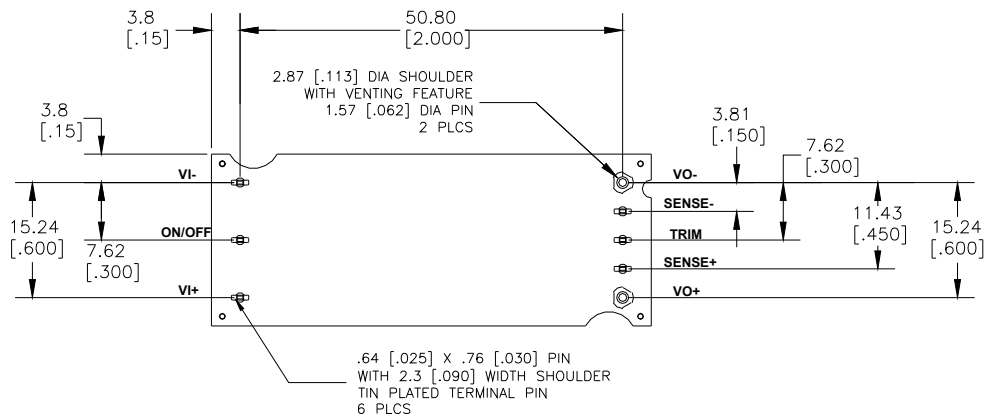

\*Bottom side label includes product designation and date code.

**\*\*Side View**

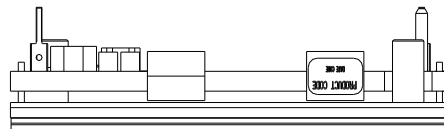

\*\*Side label contains product designation and date code.

# ESTW024A0A Series: DC-DC Converter Power Module

36 to 75V<sub>dc</sub> Input; 5V<sub>dc</sub>, 24A, 120W Output

## Mechanical Outline for Through-Hole Module with ¼ Brick Heat Plate (-18H Option) – Future development

Dimensions are in millimeters and [inches].  
 Tolerances: x.x mm ± 0.5 mm [x.xx in. ± 0.02 in.] (Unless otherwise indicated)  
 x.xx mm ± 0.25 mm [x.xxx in ± 0.010 in.]

**Top View**

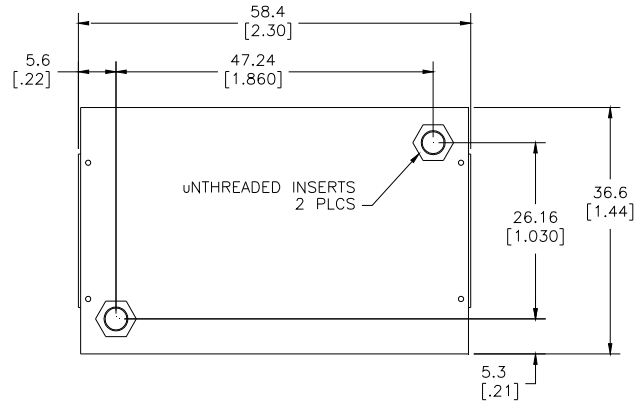

**Side View**

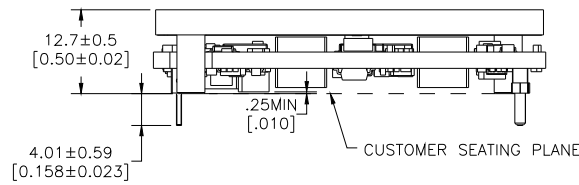

\*For optional pin lengths, see Table 2, Device Coding Scheme and Options

**Bottom View\***

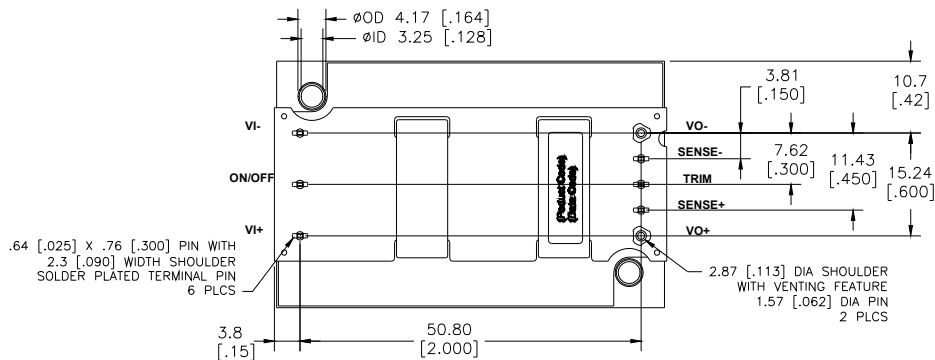

**\*\*Side View**

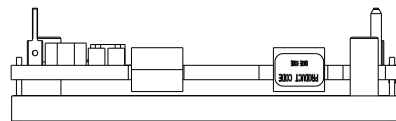

\*\*Side label contains product designation and date code.

# ESTW024A0A Series: DC-DC Converter Power Module

36 to 75V<sub>dc</sub> Input; 5V<sub>dc</sub>, 24A, 120W Output

## Recommended Pad Layout

Dimensions are in millimeters and [inches].  
 Tolerances: x.x mm ± 0.5 mm [x.xx in. ± 0.02 in.] (Unless otherwise indicated)  
 x.xx mm ± 0.25 mm [x.xxx in. ± 0.010 in.]

Pin	Function
1	Vi(+)
2	ON/OFF
3	Vi(-)
4	Vo(-)
5	SENSE(-)
6	TRIM
7	SENSE(+)
8	Vo(+)

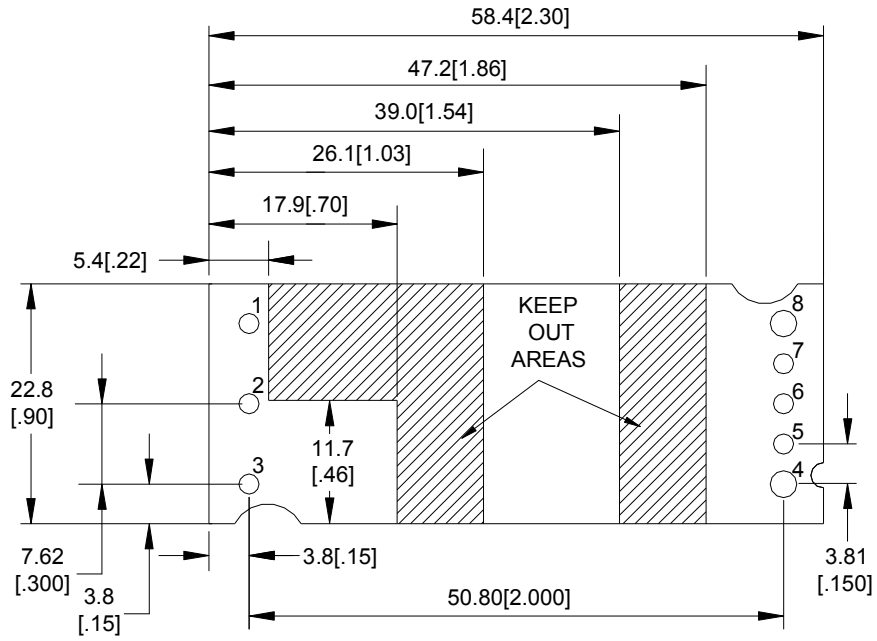

SMT Recommended Pad Layout (Component Side View)

Pin	Function
1	Vi(+)
2	ON/OFF
3	Vi(-)
4	Vo(-)
5	SENSE(-)
6	TRIM
7	SENSE(+)
8	Vo(+)

NOTES:  
 FOR 0.030" X 0.025"  
 RECTANGULAR PIN, USE  
 0.050" PLATED THROUGH  
 HOLE DIAMETER

FOR 0.62 DIA" PIN, USE  
 0.076" PLATED THROUGH  
 HOLE DIAMETER

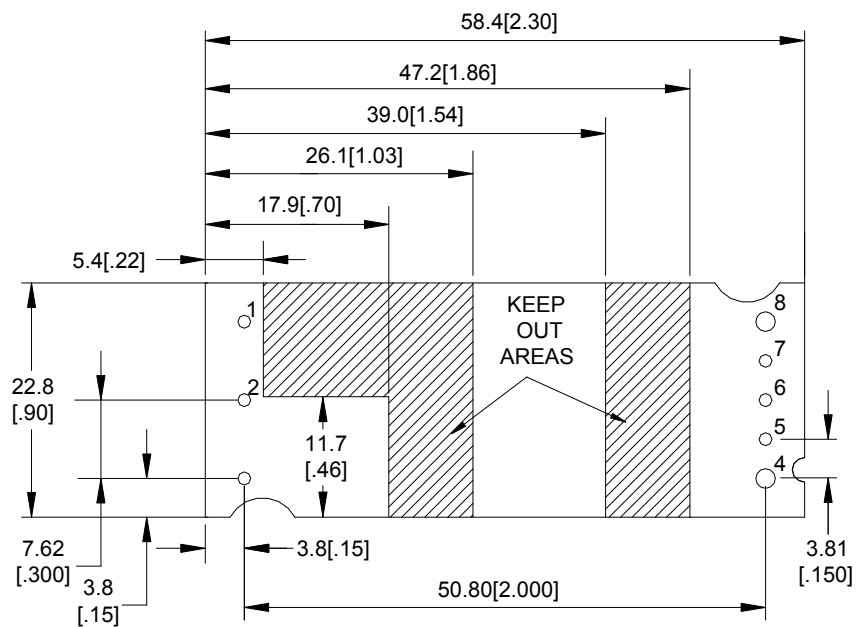

TH Recommended Pad Layout (Component Side View)

## ESTW024A0A Series: DC-DC Converter Power Module

36 to 75V<sub>dc</sub> Input; 5V<sub>dc</sub>, 24A, 120W Output

### Packaging Details

The surface mount versions of the ESTW024A0A (suffix -S) are supplied as standard in the plastic trays shown in Figure 30.

Each tray contains a total of 12 power modules. The trays are self-stacking and each shipping box for the ESTW024A0A (suffix -S) surface mount module will contain 4 full trays plus one empty hold down tray giving a total number of 48 power modules.

### Tray Specification

Material	Antistatic coated PVC
Max surface resistivity	10 <sup>12</sup> Ω/sq
Color	Clear
Capacity	12 power modules
Min order quantity	48 pcs (1 box of 4 full trays + 1 empty top tray)

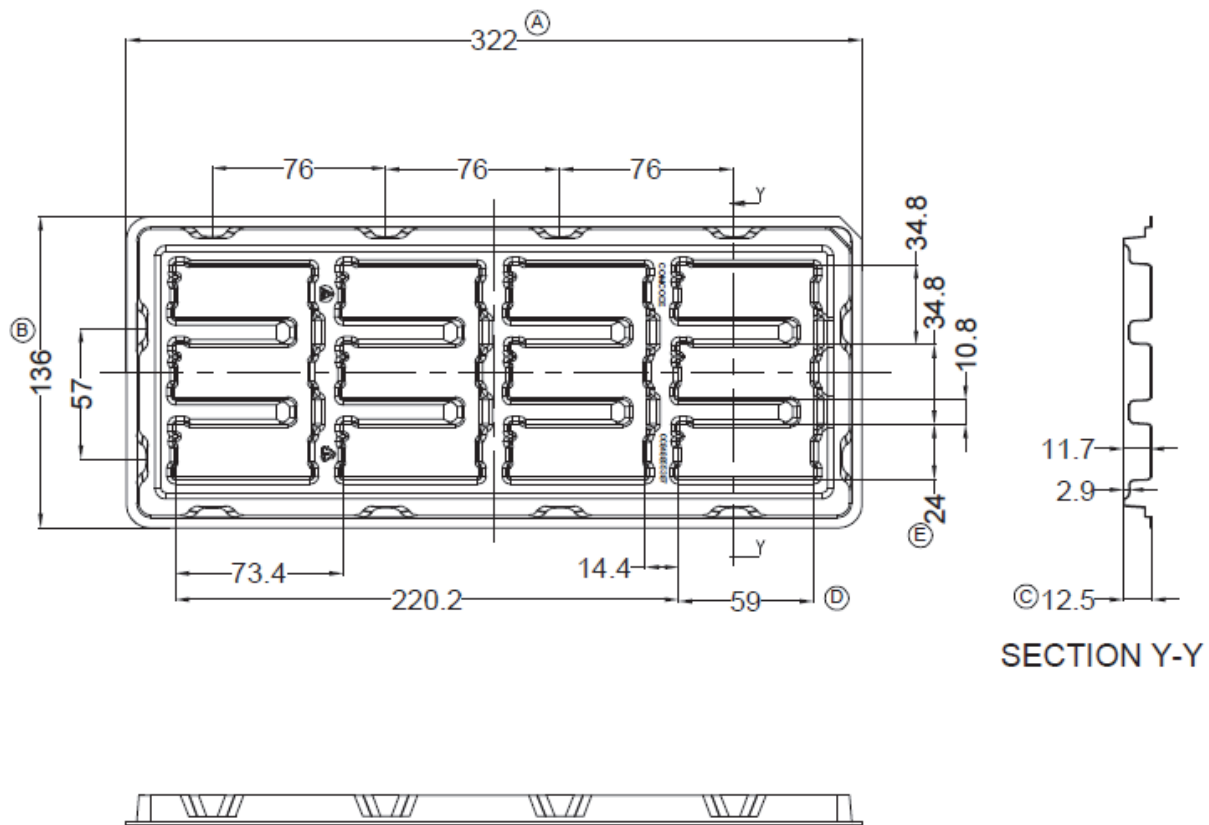

Figure 27. Surface Mount Packaging Tray

## ESTW024A0A Series: DC-DC Converter Power Module

36 to 75V<sub>dc</sub> Input; 5V<sub>dc</sub>, 24A, 120W Output

## Ordering Information

Please contact your GE Sales Representative for pricing, availability and optional features.

Table 1. Device Codes

Product Codes	Input Voltage	Output Voltage	Output Current	On/Off Logic	Connector Type	Comcodes
ESTW024A0A 41Z	48V (36-75Vdc)	5V	24A	Negative	Through hole	150037205
ESTW024A0A 41-HZ	48V (36-75Vdc)	5V	24A	Negative	Through hole	150037203
ESTW024A0A 41-SZ	48V (36-75Vdc)	5V	24A	Negative	Surface mount	150037204

Table 2. Device Coding Scheme and Options

	Characteristic	Character and Position	Definition	
Ratings	Form Factor	E	<b>E</b> = 1 /8th Brick	
	Family Designator	ST	ST = Low Power Barracuda™ Series	
	Input Voltage	W	W = Wide Range, 36V-75V	
	Output Current	024A0	<b>024A0</b> = 024.0 Amps Maximum Output Current	
	Output Voltage	A	<b>A</b> =5V Nominal	
Options	Pin Length	6 8	<b>Omit</b> = Default Pin Length shown in Mechanical Outline Figures <b>6</b> = Pin Length: 3.68 mm ± 0.25mm , (0.145 in. ± 0.010 in.) <b>8</b> = Pin Length: 2.79 mm ± 0.25mm , (0.110 in. ± 0.010 in.)	
	Action following Protective Shutdown	4	<b>4</b> = Auto-restart following shutdown (Overcurrent/Overvoltage) Must be ordered	
	On/Off Logic	1	<b>Omit</b> = Positive Logic <b>1</b> = Negative Logic	
	Customer Specific	XY	<b>XY</b> = Customer Specific Modified Code, Omit for Standard Code	
	Mechanical Features		H	<b>Omit</b> = Standard open Frame Module <b>H</b> = 1/8th Brick size heat plate, for use with heat sinks (not available with -S option)
			18H	<b>18H</b> = 1/4th Brick size heat plate with unthreaded inserts for use in coldwall applications (not available with -S option)
			S	<b>S</b> = Surface Mount connections
RoHS		Z	<b>Omit</b> = RoHS 5/6, Lead Based Solder Used <b>Z</b> = RoHS 6/6 Compliant, Lead free	

## Contact Us

For more information, call us at

USA/Canada:

**+1 888 546 3243**, or +1 972 244 9288

Asia-Pacific:

**+86.021.54279977\*808**

Europe, Middle-East and Africa:

**+49.89.878067-280**

India:

**+91.80.28411633**[www.gecriticalpower.com](http://www.gecriticalpower.com)

imagination at work



Компания «ЭлектроПласт» предлагает заключение долгосрочных отношений при поставках импортных электронных компонентов на взаимовыгодных условиях!

Наши преимущества:

- Оперативные поставки широкого спектра электронных компонентов отечественного и импортного производства напрямую от производителей и с крупнейших мировых складов;
- Поставка более 17-ти миллионов наименований электронных компонентов;
- Поставка сложных, дефицитных, либо снятых с производства позиций;
- Оперативные сроки поставки под заказ (от 5 рабочих дней);
- Экспресс доставка в любую точку России;
- Техническая поддержка проекта, помощь в подборе аналогов, поставка прототипов;
- Система менеджмента качества сертифицирована по Международному стандарту ISO 9001;
- Лицензия ФСБ на осуществление работ с использованием сведений, составляющих государственную тайну;
- Поставка специализированных компонентов (Xilinx, Altera, Analog Devices, Intersil, Interpoint, Microsemi, Aeroflex, Peregrine, Syfer, Eurofarad, Texas Instrument, Miteq, Cobham, E2V, MA-COM, Hittite, Mini-Circuits, General Dynamics и др.);

Помимо этого, одним из направлений компании «ЭлектроПласт» является направление «Источники питания». Мы предлагаем Вам помощь Конструкторского отдела:

- Подбор оптимального решения, техническое обоснование при выборе компонента;
- Подбор аналогов;
- Консультации по применению компонента;
- Поставка образцов и прототипов;
- Техническая поддержка проекта;
- Защита от снятия компонента с производства.



#### Как с нами связаться

**Телефон:** 8 (812) 309 58 32 (многоканальный)

**Факс:** 8 (812) 320-02-42

**Электронная почта:** [org@eplast1.ru](mailto:org@eplast1.ru)

**Адрес:** 198099, г. Санкт-Петербург, ул. Калинина, дом 2, корпус 4, литера А.