

Product Description

The QPD2194 is a discrete GaN on SiC HEMT which operates from 1.8-2.2 GHz. The device is a single stage pre-matched power amplifier transistor.

The QPD2194 can be used in Doherty architecture for the final stage of a base station power amplifier for macrocell high efficiency systems.

QPD2194 can deliver P_{SAT} of 371 W at +48 V operation.

Lead-free and ROHS compliant.

Functional Block Diagram

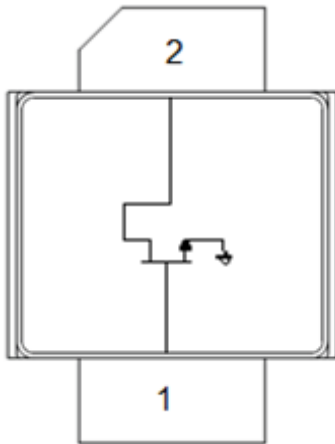

2 Lead NI400 Package

Product Features

- Operating Frequency Range: 1.8-2.2 GHz
- Operating Drain Voltage: +48 V
- Maximum Output Power (P_{SAT}): 371 W
- Maximum Drain Efficiency: 78.8%
- Efficiency-Tuned P3dB Gain: 18.0 dB
- 2-lead, earless, ceramic flange NI400 package

Applications

- W-CDMA / LTE
- Macrocell Base Station, B3-B1
- Active Antenna

Ordering Information

Part No.	ECCN	Description
QPD2194S2	EAR99	Box (2 Samples Each)
QPD2194SQ	EAR99	Tray (25 Samples)
QPD2194SR	EAR99	Reel (100 Samples)
QPD2194PCB4B01	EAR99	1805-2170 MHz Eval. Board

Absolute Maximum Ratings

Parameter	Value / Range
Gate Current (I_G)	-48 to 48 mA
Drain Voltage (V_D)	+55 V
Peak RF Input Power	44 dBm
VSWR Mismatch, P1dB Pulse (10 % duty cycle, 100 μ width), T = 25 °C	10:1

Operation of this device outside the parameter ranges given above may cause permanent damage.

Recommended Operating

Parameter	Min	Typ	Max	Units
Gate Voltage (V_G)		-2.7		V
Drain Voltage (V_D)		48		V
Quiescent Current (I_{DQ})		600		mA

Electrical performance is measured under conditions noted in the electrical specifications table. Specifications are not guaranteed over all recommended operating conditions.

RF Characterization

Parameter	Conditions	Min	Typ	Max	Units
Frequency Range		1805	-	2170	MHz
Quiescent Current			600		mA
Linear Gain			19.1		dB
P3dB			55.0		dBm
Drain Efficiency	P3dB		60.0		%

Test conditions unless otherwise noted: $V_D = +48$ V, $I_{DQ} = 600$ mA, T = 25 °C, Pulsed CW (10% duty cycle, 100 μ s width) on Class AB single-ended EVB at 1880 MHz

Thermal and Reliability Information

Parameter	Test Conditions	Value	Units
Thermal Resistance, Peak IR Surface Temperature at Average Power (θ_{JC})	$T_{CASE} = 85^\circ\text{C}$, $T_{CH} = 131^\circ\text{C}$, CW: $P_{DISS} = 60$ W, $P_{OUT} = 90$ W	0.77	$^\circ\text{C/W}$

Notes:

1. Thermal resistance measured to package backside.
2. Based on expected carrier amplifier efficiency of Doherty.
3. P_{OUT} assumes 20% peaking amplifier contribution of total average Doherty rated power.
4. Refer to the following document: [GaN Device Channel Temperature, Thermal Resistance, and Reliability Estimates](#).

QPD2194PCB4B01 Layout

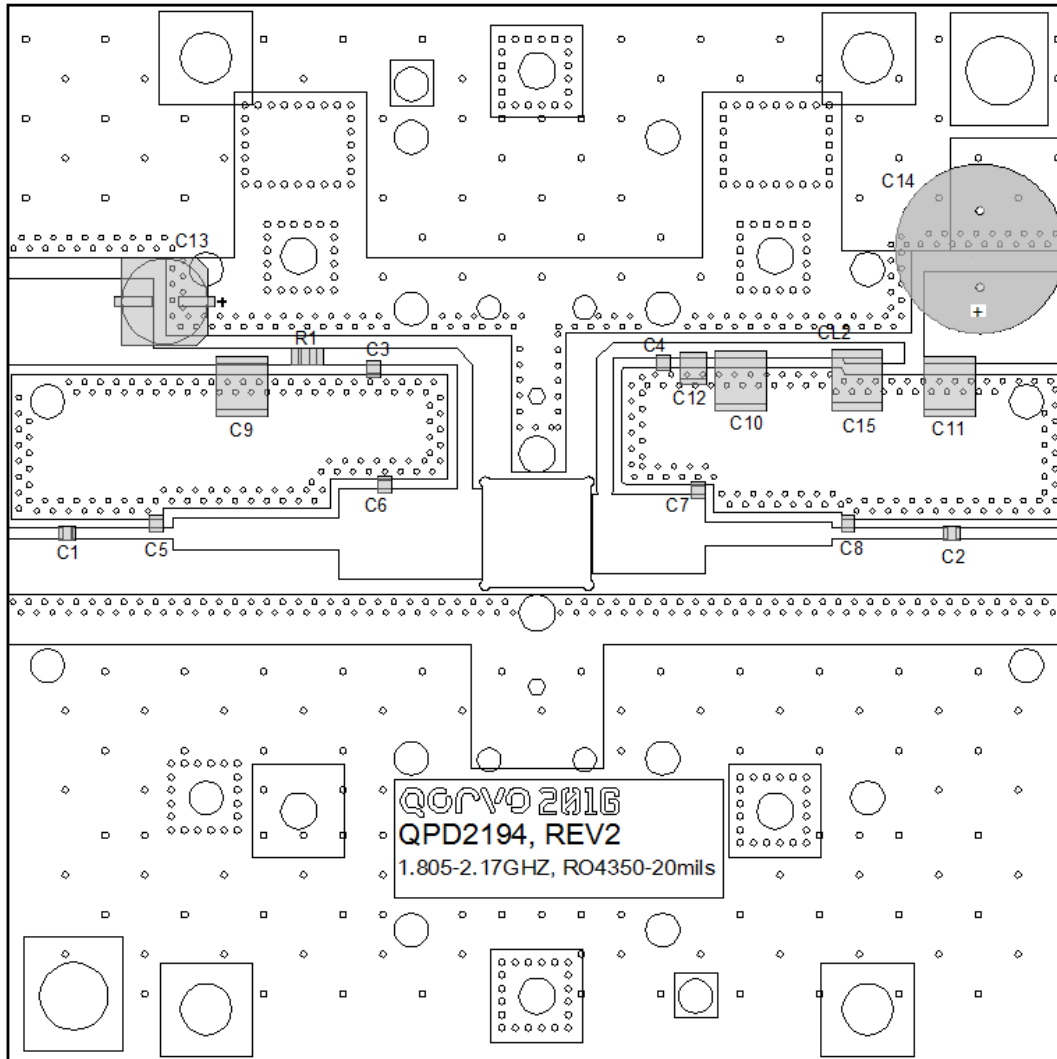

QPD2194PCB4B01 Bill of Materials

Reference Des.	Value	Description	Manuf.	Part Number
C1, C2, C3, C4	33 pF	Capacitor, 33 pF, 5%, 250 V	ATC	ATC800A330JT
C5	1.2 pF	Capacitor, 1.2 pF, ±0.1 pF, 250 V	ATC	ATC800A1R2BT250X
C6	1.9 pF	Capacitor, 1.9 pF, ±0.1 pF, 250 V	ATC	ATC800A1R9BT250X
C7	2.2 pF	Capacitor, 2.2 pF, ±0.1 pF, 250 V	ATC	ATC800A2R2BT250X
C8	0.8 pF	Capacitor, 0.8 pF, ±0.1 pF, 250 V	ATC	ATC800A0R8BT250X
C9, C10, C11, C15	4.7 µF	Capacitor, 4.7 µF, 10%, 100 V, X7R	Murata	GRM55ER72A475KA01L
C12	1 µF	Capacitor, 1 µF, 10%, 100 V, X7R	Murata	GRM32NR72A104KA01L
C13	100 µF	Capacitor, 100 µF, ±20%, 50 V, electrolytic	Panasonic	EEE-1HA101UAP
C14	220 µF	Capacitor, 220 µF, 20%, 100 V, electrolytic	Cornell	AFK227M2AR44T-F
R1	10 Ω	Resistor, 10 Ω, 1%, 1/4 W, 1206	Panasonic	ERJ-8ENF10R0V

QPD2194PCB4B01 Performance Plots

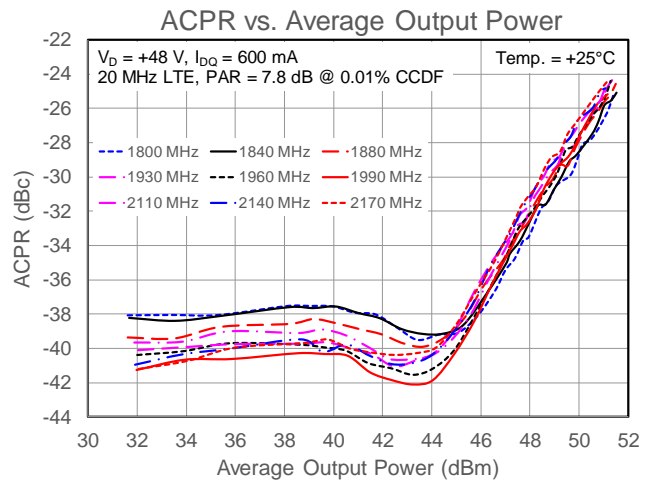
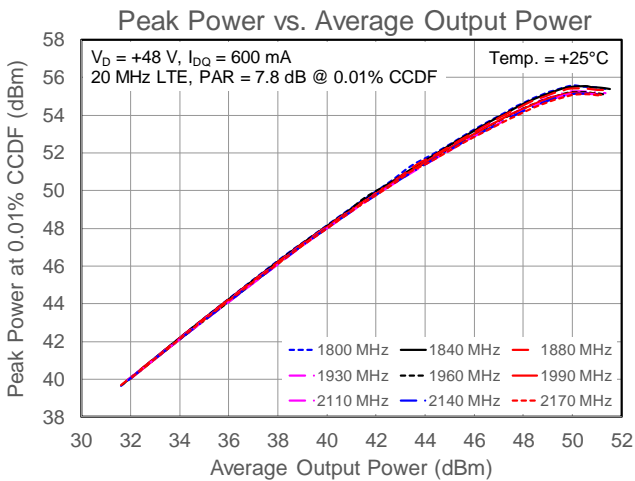
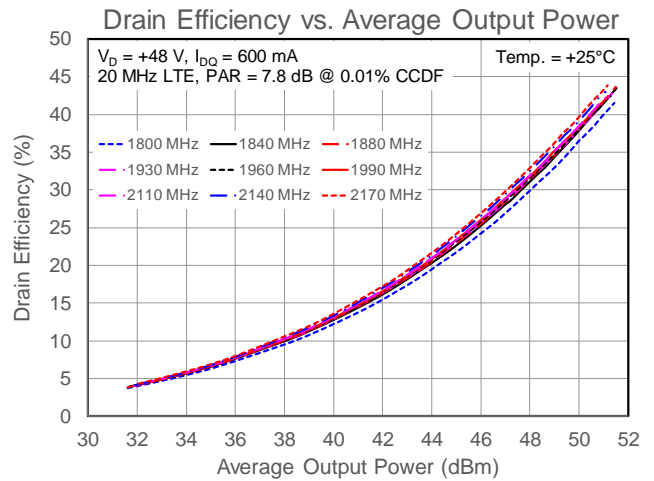
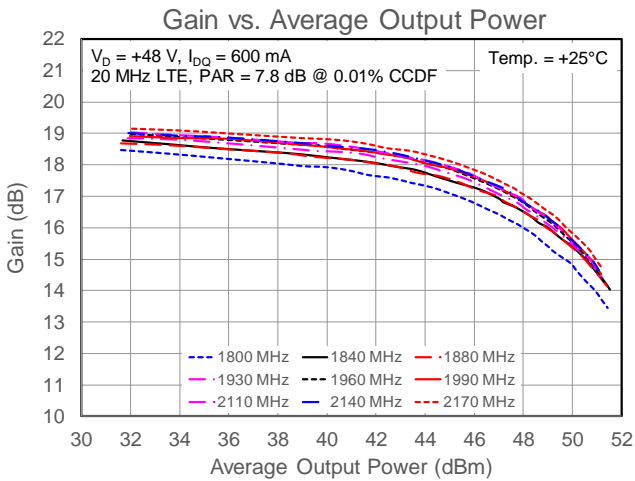
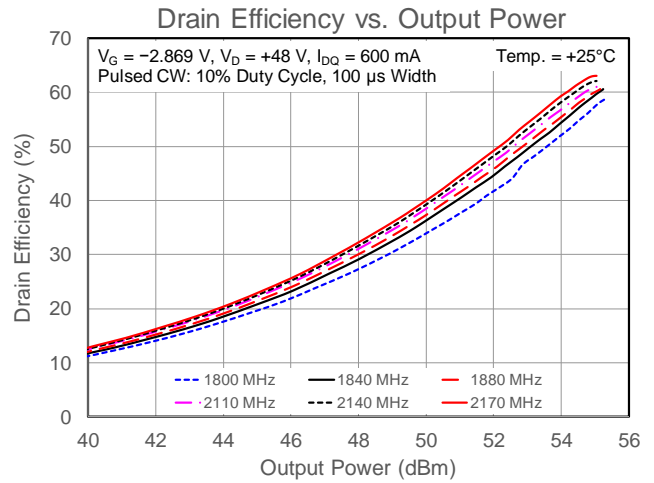
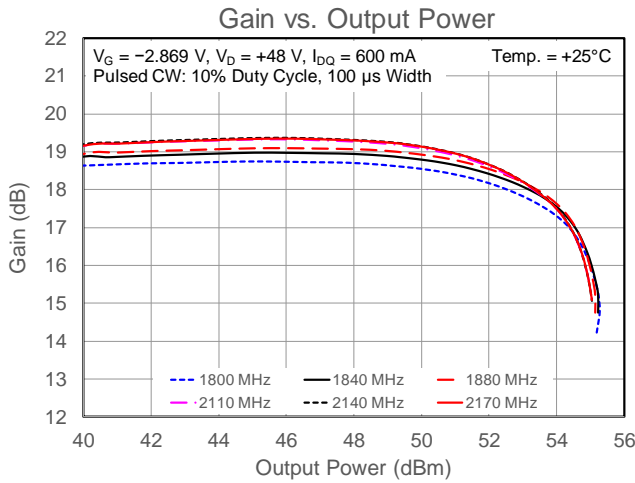

Test conditions unless otherwise noted: $V_D = +48\text{ V}$, $I_{DQ} = 600\text{ mA}$, $T = 25^\circ\text{C}$, on Class AB single-ended EVB.

QPD2194PCB4B01 Performance Plots

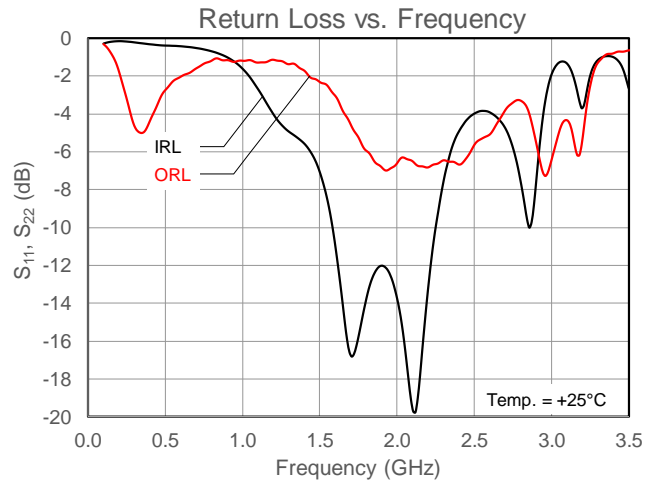
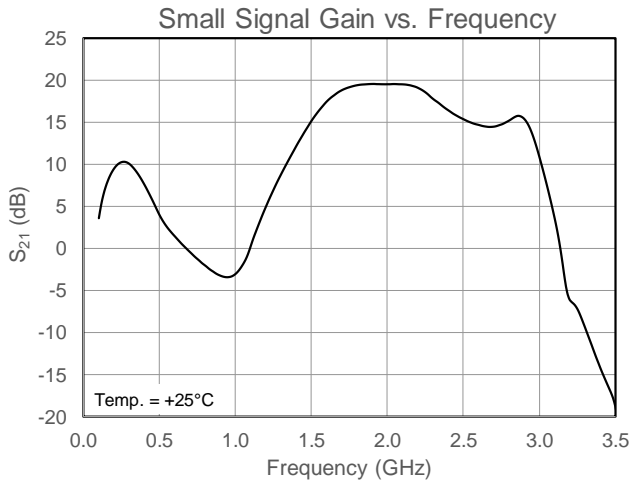

Test conditions unless otherwise noted: $V_D = +48\text{ V}$, $I_{DQ} = 600\text{ mA}$, $T = 25^\circ\text{C}$, on Class AB single-ended EVB.

Power-Tuned Load Pull Performance

Frequency (MHz)	Source Impedance	Load Impedance	Gain @ P3dB (dB)	P3dB (dBm)	Drain Efficiency (%)
1800	6.21 – j1.70	6.15 – j5.81	15.1	55.4	54.0
1840	2.31 – j5.94	6.15 – j5.82	15.9	55.7	57.0
1880	4.21 – j2.56	6.00 – j4.30	16.4	55.7	62.5
2110	4.06 – j5.02	6.52 – j2.92	16.4	55.6	66.6
2140	4.24 – j5.12	8.50 – j2.10	15.7	55.6	59.4
2170	1.55 – j2.71	8.00 – j2.10	16.1	55.6	62.2

Test conditions unless otherwise noted: $V_D = +48\text{ V}$, $I_{DQ} = 600\text{ mA}$, $T = 25^\circ\text{C}$, Pulsed (10% duty cycle, 100 μs width)

Efficiency-Tuned Load Pull Performance

Frequency (MHz)	Source Impedance	Load Impedance	Gain @ P3dB (dB)	P3dB (dBm)	Drain Efficiency (%)
1800	6.21 – j1.70	2.50 – j1.70	16.8	53.6	70.9
1840	2.31 – j5.94	2.92 – j2.22	17.6	54.3	73.3
1880	4.21 – j2.56	2.53 – j2.80	18.0	54.1	78.8
2110	4.06 – j5.02	2.14 – j3.38	17.6	52.6	78.4
2140	4.24 – j5.12	3.30 – j3.90	17.5	53.8	75.7
2170	1.55 – j2.71	2.23 – j4.27	18.0	52.2	77.7

Test conditions unless otherwise noted: $V_D = +48\text{ V}$, $I_{DQ} = 600\text{ mA}$, $T = 25^\circ\text{C}$, Pulsed (10% duty cycle, 100 μs width)

Load Pull Plots

Load Pull at 1.8 GHz

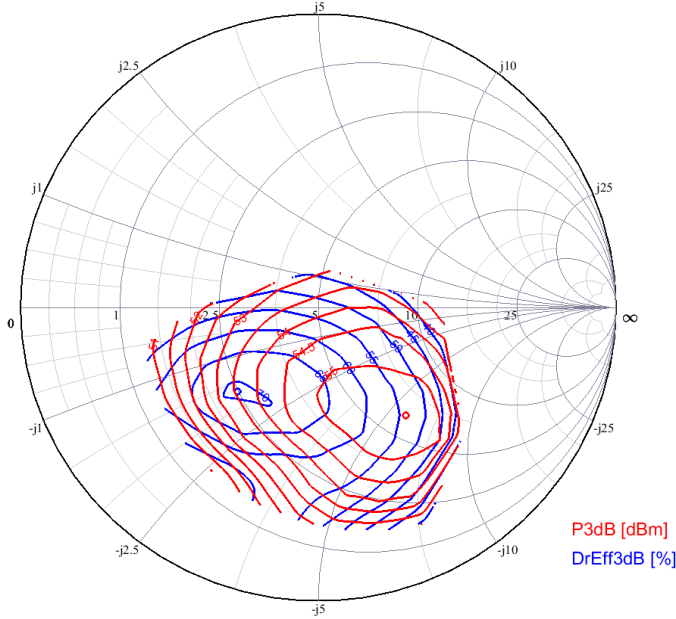

Load Pull at 1.84 GHz

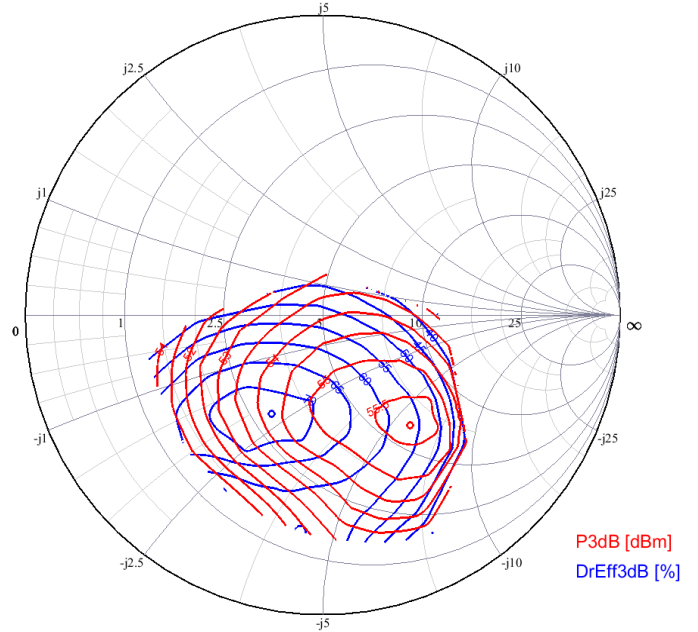

Load Pull at 1.88 GHz

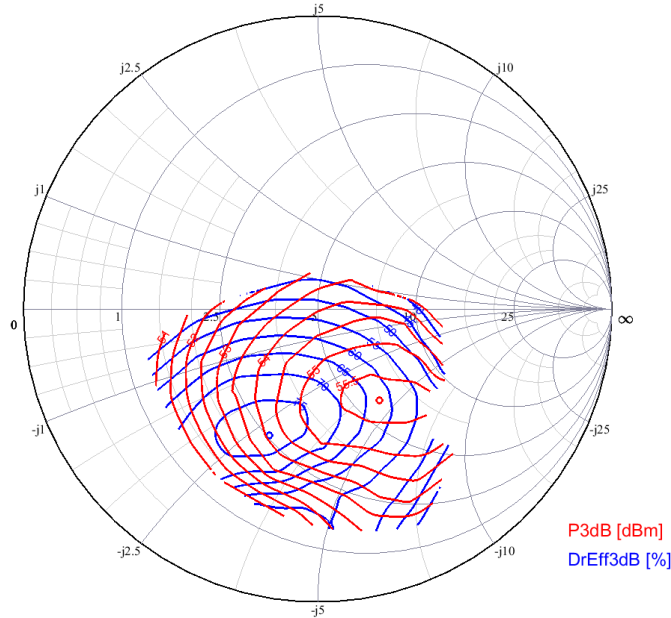

Test conditions unless otherwise noted: $V_D = +48\text{ V}$, $I_{DQ} = 600\text{ mA}$, $T = 25^\circ\text{C}$, Pulsed (10% duty cycle, 100 μs width)

Load Pull Plots

Load Pull at 2.11 GHz

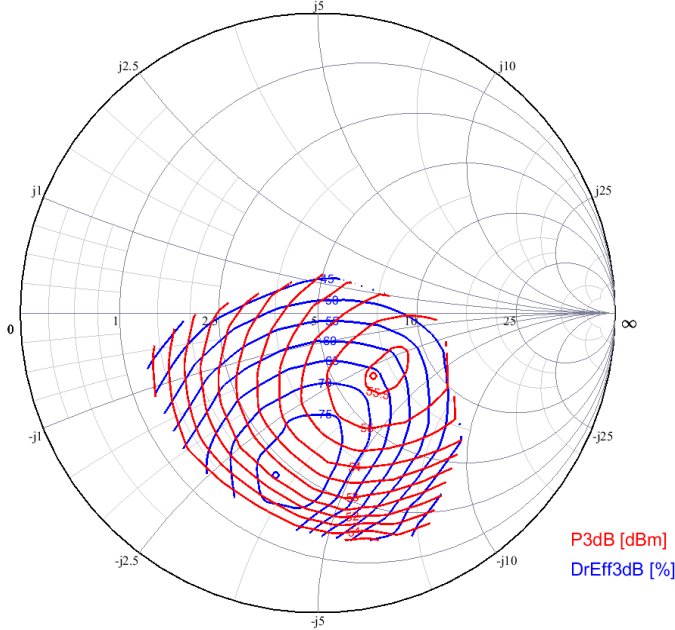

Load Pull at 2.14 GHz

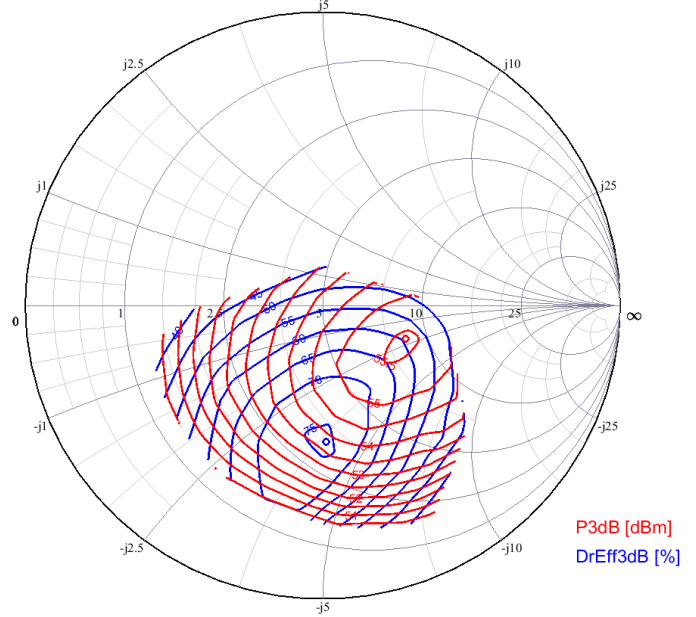

Load Pull at 2.17 GHz

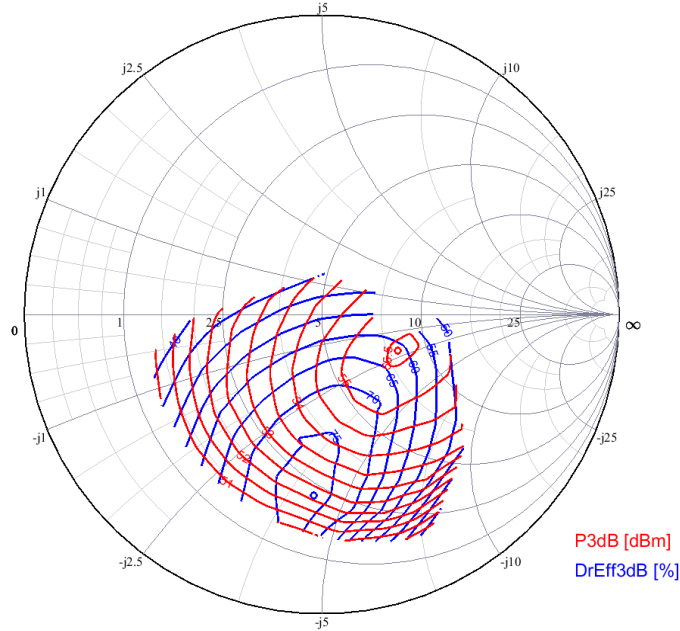

Test conditions unless otherwise noted: $V_D = +48\text{ V}$, $I_{DQ} = 600\text{ mA}$, $T = 25^\circ\text{C}$, Pulsed (10% duty cycle, 100 μs width)

Pin Configuration

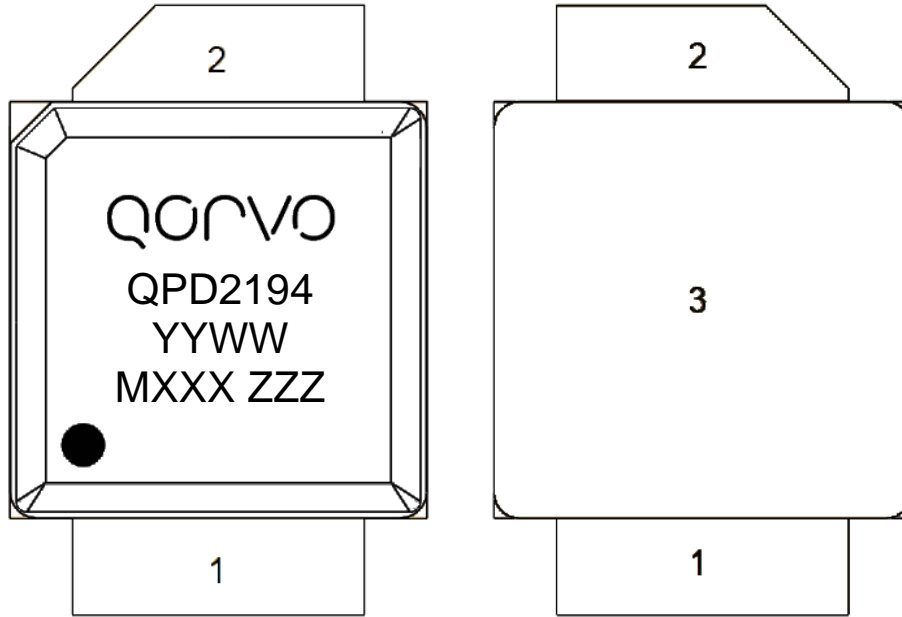

Pin Description

Pin No.	Label	Description
1	RF IN, VG	RF Input, Gate Bias
2	RF OUT, VD	RF Output, Drain Bias
3 (Backside Paddle)	RF/DC GND	RF/DC Ground

Package Marking and Dimensions

Marking: Qorvo Logo
 Part Number – QPD2194
 Date Code – YYWW
 Production Lot Number – MXXX
 Serial Number – ZZZ

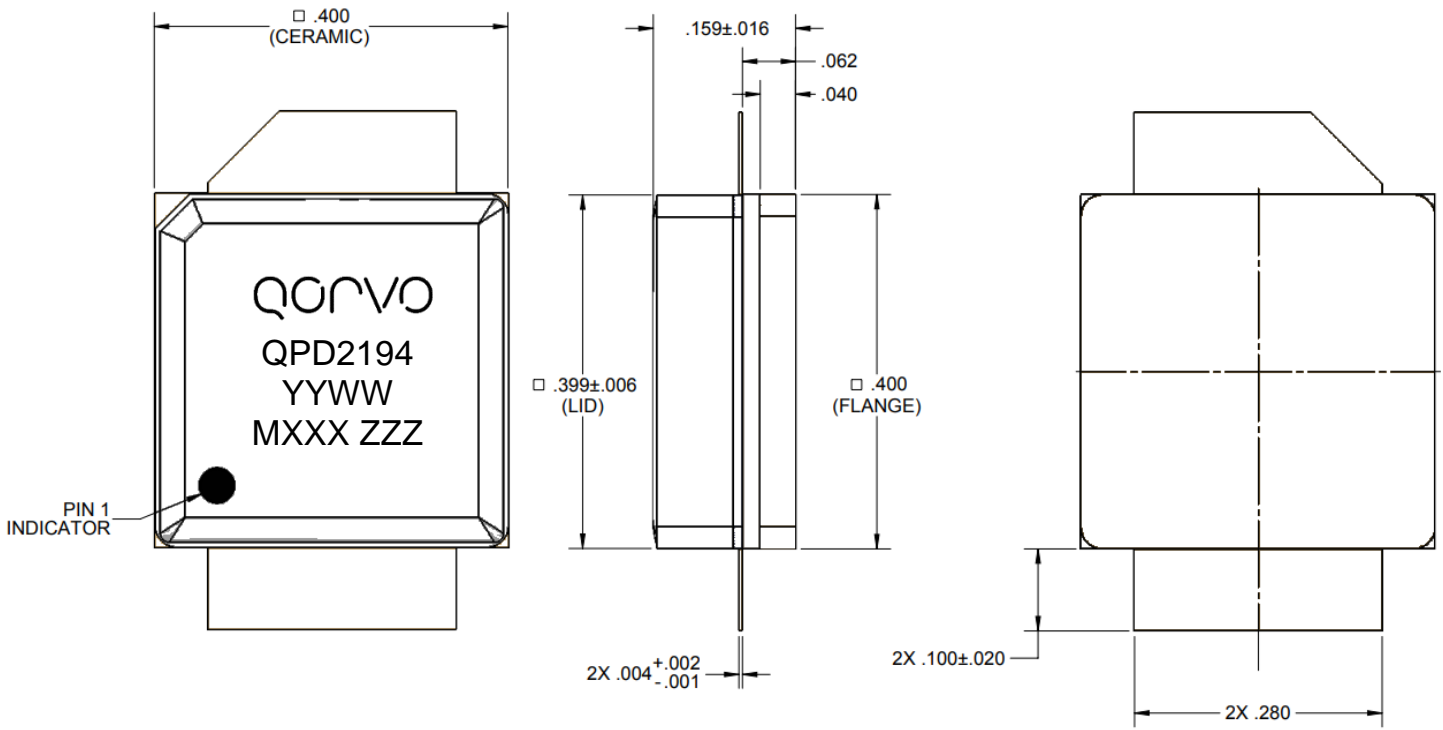

Notes: Unless Otherwise Specified;

- Material:
 - Package Base: Ceramic/Metal
 - Package Lid: Ceramic
- Package exposed metallization is NiAu plated. Au thickness is minimum 60 μm .
- Part is epoxy sealed.
- Part meets industry NI400 footprint.
- Body dimensions do not include lid shift or epoxy run out, which can be up to 0.020 per side.
- Dimensions are in inches. General tolerance is ± 0.005 .

Tape and Reel Information – Carrier and Cover Tape Dimensions

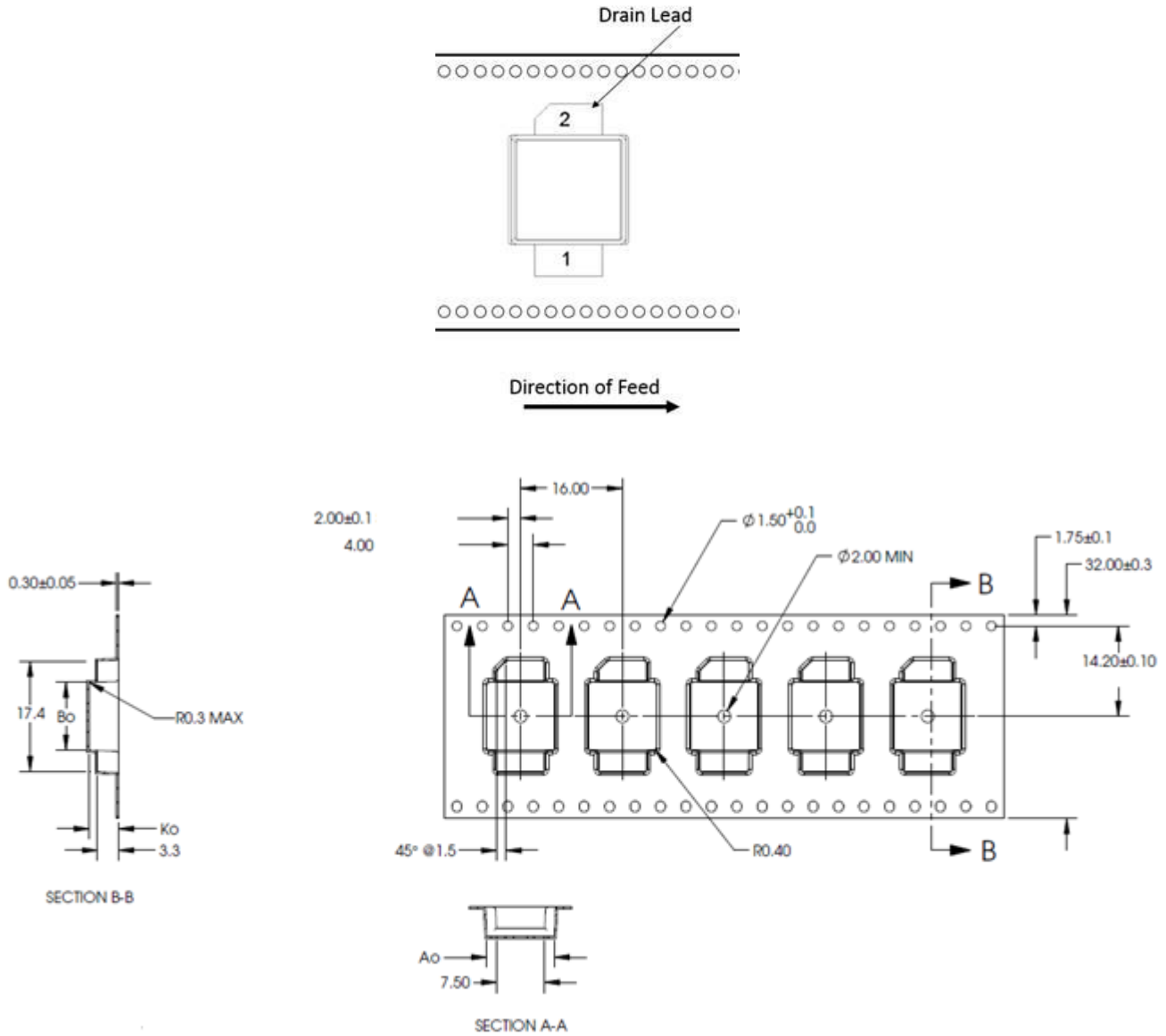

Feature	Measure	Symbol	Size (in)	Size (mm)
Cavity	Length	A0	0.417	10.60
	Width	B0	0.419	10.65
	Depth	K0	0.181	4.60
	Pitch	P1	0.630	16
Centerline Distance	Cavity to Perforation – Length Direction	P2	0.079	2.00
	Cavity to Perforation – Width Direction	F	0.559	14.20
Cover Tape	Width	C	1.004	25.50
Carrier Tape	Width	W	1.260	32

Tape and Reel Information – Reel Dimensions

Standard T/R size = 100 pieces on a 13" reel.

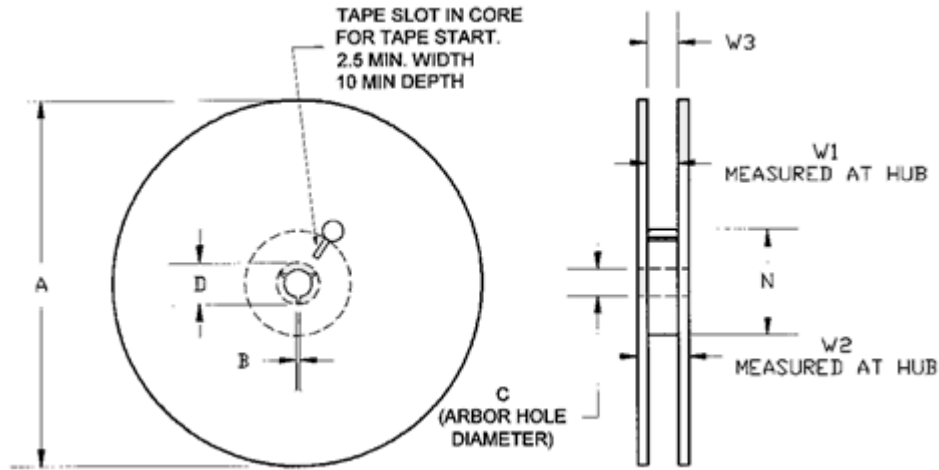

Feature	Measure	Symbol	Size (in)	Size (mm)
Flange	Diameter	A	12.992	330.0
	Thickness	W2	1.504	38.2
	Space Between Flange	W1	1.291	32.8
Hub	Outer Diameter	N	4.016	102.0
	Arbor Hole Diameter	C	0.512	13.0
	Key Slit Width	B	0.079	2.0
	Key Slit Diameter	D	0.787	20.0

Tape and Reel Information – Tape Length and Label Placement

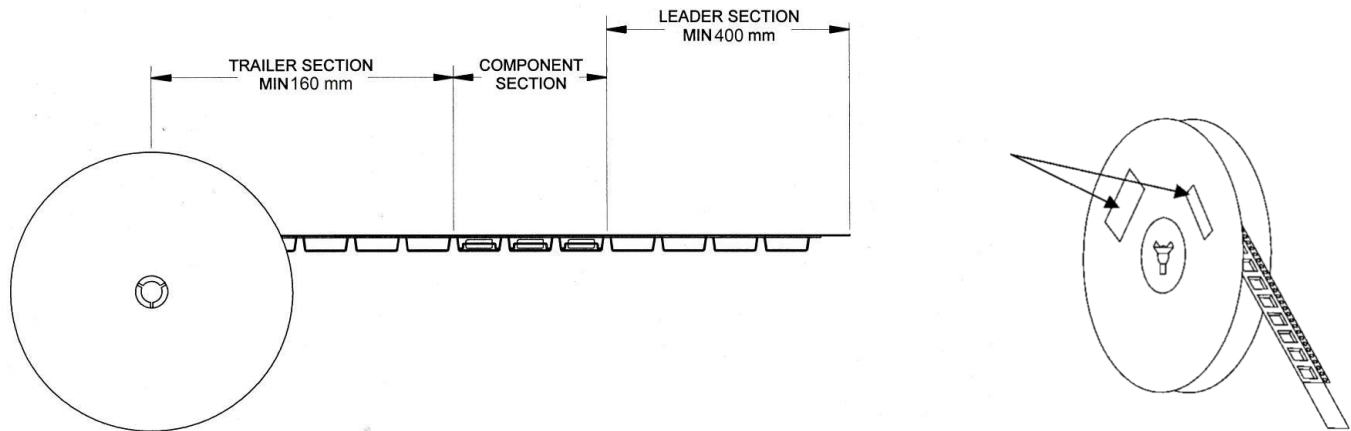

Notes:

1. Empty part cavities at the trailing and leading ends are sealed with cover tape. See EIA 481-1-A.
2. Labels are placed on the flange opposite the sprockets in the carrier tape.

Handling Precautions

Parameter	Rating	Standard
ESD – Human Body Model (HBM)	Class 1B	ANSI/ESDA/JEDEC Standard JS-001
ESD – Charged Device Model (CDM)	Class C3	ANSI/ESDA/JEDEC Standard JS-002
MSL – 260°C Convection Reflow	Level 3	IPC/JEDEC Standard J-STD-020



Solderability

Compatible with lead-free (260°C maximum reflow temperature) soldering processes. The use of no-clean solder to avoid washing after soldering is recommended. Contact plating is NiAu. Au thickness is minimum 60 µin.

RoHS Compliance

This product is compliant with the 2011/65/EU RoHS directive (Restrictions on the Use of Certain Hazardous Substances in Electrical and Electronic Equipment), as amended by Directive 2015/863/EU. This product also has the following attributes:

- Lead Free
- Antimony Free
- TBBP-A (C₁₅H₁₂Br₄O₂) Free
- PFOS Free
- SVHC Free

Contact Information

For the latest specifications, additional product information, worldwide sales and distribution locations, and information about Qorvo:

Web: www.qorvo.com **Tel:** +1.972.994.8465
Email: info-sales@qorvo.com **Fax:** +1.972.994.8504

For technical questions and application information:

Email: BTSApplications@qorvo.com

Important Notice

The information contained herein is believed to be reliable; however, Qorvo makes no warranties regarding the information contained herein and assumes no responsibility or liability whatsoever for the use of the information contained herein. All information contained herein is subject to change without notice. Customers should obtain and verify the latest relevant information before placing orders for Qorvo products. The information contained herein or any use of such information does not grant, explicitly or implicitly, to any party any patent rights, licenses, or any other intellectual property rights, whether with regard to such information itself or anything described by such information. **THIS INFORMATION DOES NOT CONSTITUTE A WARRANTY WITH RESPECT TO THE PRODUCTS DESCRIBED HEREIN, AND QORVO HEREBY DISCLAIMS ANY AND ALL WARRANTIES WITH RESPECT TO SUCH PRODUCTS WHETHER EXPRESS OR IMPLIED BY LAW, COURSE OF DEALING, COURSE OF PERFORMANCE, USAGE OF TRADE OR OTHERWISE, INCLUDING THE IMPLIED WARRANTIES OF MERCHANTABILITY AND FITNESS FOR A PARTICULAR PURPOSE.**

Without limiting the generality of the foregoing, Qorvo products are not warranted or authorized for use as critical components in medical, life-saving, or life-sustaining applications, or other applications where a failure would reasonably be expected to cause severe personal injury or death.

Copyright 2018 © Qorvo, Inc. | Qorvo is a registered trademark of Qorvo, Inc.



Компания «ЭлектроПласт» предлагает заключение долгосрочных отношений при поставках импортных электронных компонентов на взаимовыгодных условиях!

Наши преимущества:

- Оперативные поставки широкого спектра электронных компонентов отечественного и импортного производства напрямую от производителей и с крупнейших мировых складов;
- Поставка более 17-ти миллионов наименований электронных компонентов;
- Поставка сложных, дефицитных, либо снятых с производства позиций;
- Оперативные сроки поставки под заказ (от 5 рабочих дней);
- Экспресс доставка в любую точку России;
- Техническая поддержка проекта, помощь в подборе аналогов, поставка прототипов;
- Система менеджмента качества сертифицирована по Международному стандарту ISO 9001;
- Лицензия ФСБ на осуществление работ с использованием сведений, составляющих государственную тайну;
- Поставка специализированных компонентов (Xilinx, Altera, Analog Devices, Intersil, Interpoint, Microsemi, Aeroflex, Peregrine, Syfer, Eurofarad, Texas Instrument, Miteq, Cobham, E2V, MA-COM, Hittite, Mini-Circuits, General Dynamics и др.);

Помимо этого, одним из направлений компании «ЭлектроПласт» является направление «Источники питания». Мы предлагаем Вам помощь Конструкторского отдела:

- Подбор оптимального решения, техническое обоснование при выборе компонента;
- Подбор аналогов;
- Консультации по применению компонента;
- Поставка образцов и прототипов;
- Техническая поддержка проекта;
- Защита от снятия компонента с производства.



Как с нами связаться

Телефон: 8 (812) 309 58 32 (многоканальный)

Факс: 8 (812) 320-02-42

Электронная почта: org@eplast1.ru

Адрес: 198099, г. Санкт-Петербург, ул. Калинина, дом 2, корпус 4, литера А.