

AF0500 SERIES

Arc-Flash Relay

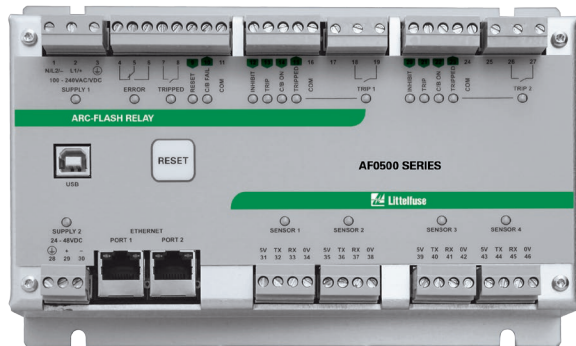

Description

The AF0500 is a microprocessor-based arc-flash relay that limits arc-fault damage by detecting the light from an arc flash and rapidly tripping the feeder breaker. The unit is well suited for switchgear, transformer and power converter applications.

Sensors, inputs, and connections are health monitored to ensure fail-safe operation. A secondary solid-state trip circuit provides a redundant trip path. A USB port is used for configuration and access to event logs.

AF0500 includes an Ethernet interface and supports Modbus® TCP communication. Zone tripping, upstream breaker tripping and tie breaker tripping applications can be easily configured.

A number of control inputs allows interconnection of multiple AF0500 units to form a system.

Features & Benefits

FEATURES	BENEFITS
4 arc sensor inputs	Supports both point and fiber sensors
Arc-Flash trip time <1ms	Limits arc-flash damage and risk of injury
2 IGBT high speed trip outputs	Supports applications such as upstream breaker tripping or tie breaker tripping
Universal Power Supply	100-240 Vac, 24-48 Vdc, or 110-250 Vdc supply
Fail-safe system	Continuous monitoring of optical sensors and inputs ensures protection
LED indication (on unit and each sensor)	Trip and sensor status indicated both on relay and sensors
Discrete wire networking	Multiple AF0500 units can be interconnected to form a system
USB interface	Data logging and configuration software uses a USB interface with no drivers or software installation
Data logging	On-board event recorder for system diagnostics (2048 log lines)
Ethernet interface	Modbus® TCP communication

Optical Sensors

The AF0500 accepts both PGA-LS10 point sensors and PGA-LS20/PGA-LS30 fiber-optical sensors. Thus any combination of fiber or point sensors is supported.

For fast fault location, front-panel and sensor LEDs indicate sensor health and which sensor detected an arc fault.

Sensor Placement

The AF0500 Arc-Flash Relay and sensors are easily installed in retrofit projects and new switchgear with little or no re-configuration. Simple applications work straight out of the box with no need of PC configuration. More complex systems with multiple power sources are configured using the relay's built-in USB interface software.



Generally, it is recommended to mount 1 or 2 sensors per cubicle to cover all horizontal and vertical bus bars, breaker compartments, drawers, and anywhere that there is a risk for an arc fault. Threading a fiber-optic sensor through the cabinets and in areas where point-sensor coverage is uncertain results in complete coverage and an added level of redundancy. Even if policy is to only work on de-energized systems, all maintenance areas should be monitored to prevent potential damage and additional cost.

Ordering Information

ORDERING NUMBER	DESCRIPTION
AF0500-00	Arc-Flash Relay
AF0500-00-CC	Arc-Flash Relay, Conformally Coated

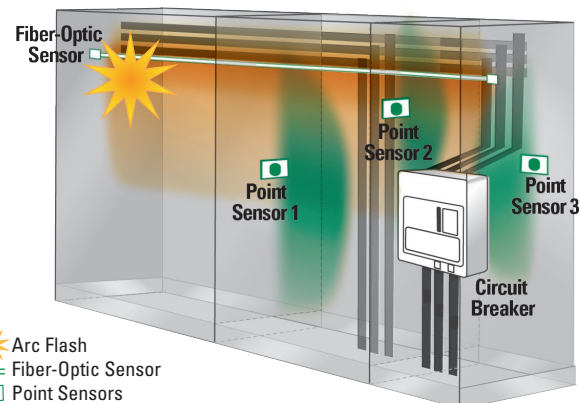
ACCESSORIES	REQUIREMENT
PGA-LS10	Required*
PGA-LS20, PGA-LS30	Required*
PGA-1100	Optional



 Arc Flash
 Fiber-Optic Sensor
 Point Sensors

AF0500 SERIES

Applications

Zone Tripping

AF0500 can trip 2 separate zones. Sensors can be assigned to the zones individually through PC configuration.

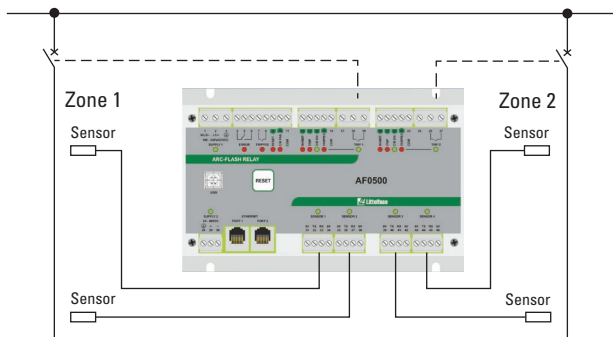

Upstream Breaker Tripping

In case of failure of the local circuit breaker to open, another trip command is sent after a short delay to an upstream breaker to clear the fault.

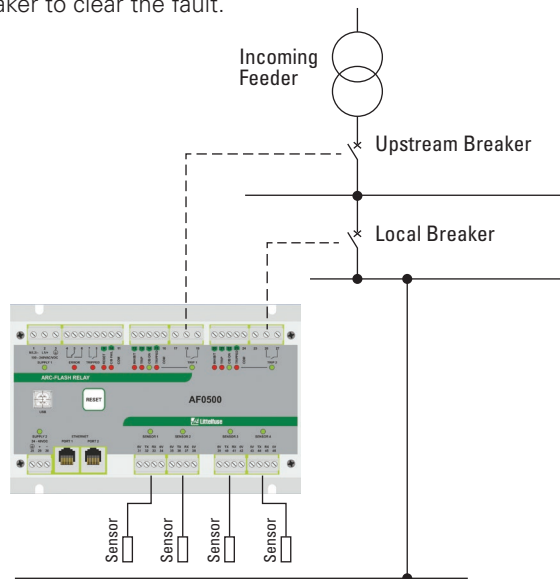

Tie Breaker Tripping

In case of an arc in one section of the switchboard, the AF0500 can trip both the incoming feeder and the tie breaker simultaneously. Thus the affected part of the switchboard is isolated from the non-affected part.

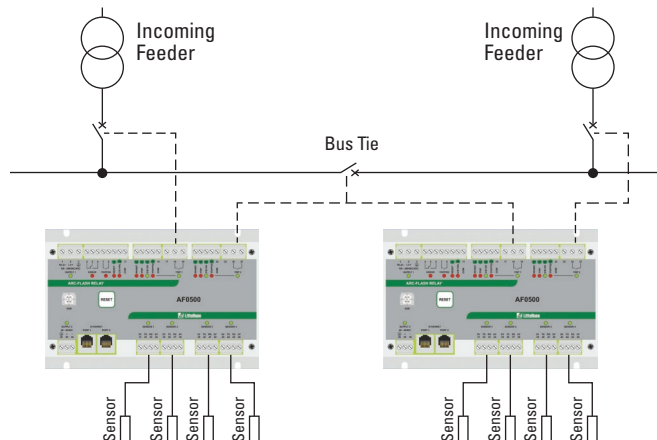

Accessories



PGA-LS10 Point Sensor

Line-of-sight light sensor detects an arc as small as 3 kA within a 2-m half-sphere. Includes Sensor health and trip indication.



PGA-LS20/PGA-LS30 Fiber-Optic Sensor

360° light sensor to run along bus bars. Sensor health and trip indication.



PGA-1100 Diode Logic Unit

This module allows multiple arc-flash relays to trip a common breaker, for example a tie-breaker.

Specifications

Power Supply

Universal 100 to 240 Vac (+10%, -15%) 50/60 Hz, 20 VA,
110 to 250 Vdc (+10%, -20%) 8 W

Low Voltage 24 to 48 Vdc (+10%, -20%), 4 W

Sensor Inputs 4 light sensor inputs for PGA-LS10, PGA-LS20 and PGA-LS30 sensors

Trip Outputs 2 IGBT switches

UL Rating 120/240 Vac, 1800 VA, 0.75 A maximum continuous,
125/250 Vdc, 138 VA, 0.75 A maximum continuous

Supplemental Rating

Make/Carry 30 A for 0.2s

Voltage Rating 24 to 300 Vac, 24 to 300 Vdc

Current Rating 20 A for 2 s, 10 A for 5 s

Communication

Ethernet, 2 ports with internal Ethernet switch, Modbus® TCP

Dimensions

H 130 mm (5.1"); **W** 200 mm (7.9"); **D** 54 mm (2.1")

Shipping Weight

0.9 kg (2 lb)

Operating Temp.

-40°C to +70°C (-40°F to 158°F)

Approvals

UL Listed (UL508), CE, RCM, FCC, CSA

Warranty

5 years

Mounting

Surface, DIN (with optional D0050 adapter clips)



Компания «ЭлектроПласт» предлагает заключение долгосрочных отношений при поставках импортных электронных компонентов на взаимовыгодных условиях!

Наши преимущества:

- Оперативные поставки широкого спектра электронных компонентов отечественного и импортного производства напрямую от производителей и с крупнейших мировых складов;
- Поставка более 17-ти миллионов наименований электронных компонентов;
- Поставка сложных, дефицитных, либо снятых с производства позиций;
- Оперативные сроки поставки под заказ (от 5 рабочих дней);
- Экспресс доставка в любую точку России;
- Техническая поддержка проекта, помощь в подборе аналогов, поставка прототипов;
- Система менеджмента качества сертифицирована по Международному стандарту ISO 9001;
- Лицензия ФСБ на осуществление работ с использованием сведений, составляющих государственную тайну;
- Поставка специализированных компонентов (Xilinx, Altera, Analog Devices, Intersil, Interpoint, Microsemi, Aeroflex, Peregrine, Syfer, Eurofarad, Texas Instrument, Miteq, Cobham, E2V, MA-COM, Hittite, Mini-Circuits, General Dynamics и др.);

Помимо этого, одним из направлений компании «ЭлектроПласт» является направление «Источники питания». Мы предлагаем Вам помощь Конструкторского отдела:

- Подбор оптимального решения, техническое обоснование при выборе компонента;
- Подбор аналогов;
- Консультации по применению компонента;
- Поставка образцов и прототипов;
- Техническая поддержка проекта;
- Защита от снятия компонента с производства.



Как с нами связаться

Телефон: 8 (812) 309 58 32 (многоканальный)

Факс: 8 (812) 320-02-42

Электронная почта: org@eplast1.ru

Адрес: 198099, г. Санкт-Петербург, ул. Калинина, дом 2, корпус 4, литера А.