

## SM11T Series Miniature SMD Crystal

April 2015

- The Pletronics' SM11T Series is a miniature surface mount crystal.
- Package is ideal for automated surface mount assembly and reflow practices.
- Tape and Reel packaging
- 8 MHz to 150 MHz Fundamental
- 70 MHz to 300 MHz 3<sup>rd</sup> Overtone
- 120 MHz to 250 MHz 5<sup>th</sup> Overtone
- 3.2 x 5 mm 4 pad
- AT Cut Crystal
- Ideal for use in hand held consumer products.

**Pletronics Inc. certifies this device is in accordance with the  
RoHS 6/6 (2011/65/EC) and WEEE (2002/96/EC) directives.**

Pletronics Inc. guarantees the device does not contain the following:

Cadmium, Hexavalent Chromium, Lead, Mercury, PBB's, PBDE's

Weight of the Device: 0.06 grams

Moisture Sensitivity Level: 1 As defined in J-STD-020D.1

Second Level Interconnect code: e4



### Electrical Specification:

Item	Min	Max	Unit	Condition	
Frequency Range	8	300	MHz	Fundamental, 3 <sup>rd</sup> and 5 <sup>th</sup> Overtone Modes	
Calibration Frequency Tolerance	10	50	ppm	at +25°C ± 3°C, see part number for options	
Frequency Stability over OTR	3	150	ppm	see part number for available options	
Equivalent Series Resistance (ESR)	-	100	Ohms	8MHz to 10MHz	Fundamental Mode
	-	80	Ohms	10 MHz to 16 MHz	
	-	60	Ohms	16 MHz to 20 MHz	
	-	50	Ohms	above 20 MHz	
	-	100	Ohms	70 MHz to 300 MHz	3 <sup>rd</sup> Overtone Mode
	-	160	Ohms	120 MHz to 250 MHz	5 <sup>th</sup> overtone Mode
Drive Level	-	100	µW	use 10 µW for testing	
Shunt Capacitance (C0)	-	5	pF	Pad to Pad capacitance	
Aging at 25°C ± 3°C	-3	+3	ppm /Yr	for the first year	
	-2	+2	ppm /Yr	after the first year	
Operating Temperature Range	-40	+125	°C	see part number for available options	
Storage Temperature Range	-55	+125	°C		

### AT Cut Crystal Frequency versus Temperature Typical Performance:

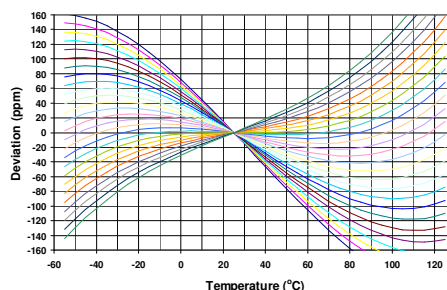

**Part Number:**

SM11T -18 -14.31818M- 20 E 1 L K -XX

See chart below for available options

Internal code or blank
<b>Highest Specified Operating Temperature</b> <b>A</b> = 40°C <b>G</b> = 70°C <b>N</b> = 100°C <b>B</b> = 45°C <b>H</b> = 75°C <b>P</b> = 105°C <b>C</b> = 50°C <b>J</b> = 80°C <b>R</b> = 110°C <b>D</b> = 55°C <b>K</b> = 85°C <b>S</b> = 115°C <b>E</b> = 60°C <b>L</b> = 90°C <b>T</b> = 120°C <b>F</b> = 65°C <b>M</b> = 95°C <b>U</b> = 125°C
<b>Lowest Specified Operating Temperature</b> <b>A</b> = +10°C <b>F</b> = -15°C <b>L</b> = -40°C <b>B</b> = +5°C <b>G</b> = -20°C <b>M</b> = -45°C <b>C</b> = 0°C <b>H</b> = -25°C <b>N</b> = -50°C <b>D</b> = -5°C <b>J</b> = -30°C <b>P</b> = -55°C <b>E</b> = -10°C <b>K</b> = -35°C
<b>Mode:</b> <b>1</b> =Fundamental <b>3</b> = 3 <sup>rd</sup> OT <b>5</b> = 5 <sup>th</sup> OT
<b>Frequency Stability</b> See chart below
<b>Calibration Frequency Tolerance</b> (Typ. Values shown) <b>10</b> = ± 10 ppm at 25°C ± 3°C <b>15</b> = ± 15 ppm at 25°C ± 3°C <b>20</b> = ± 20 ppm at 25°C ± 3°C <b>30</b> = ± 30 ppm at 25°C ± 3°C <b>50</b> = ± 50 ppm at 25°C ± 3°C (Standard)
<b>Frequency in MHz</b>
<b>Clload in pF</b> Parallel Resonance from <b>06</b> to <b>32</b> pF or <b>SR</b> = Series Resonance
<b>Model Number</b>

Operating Temperature Range		Available Frequency Stability versus Temperature in ppm									
		CODE	A	B	C	D	E	F	G	H	J
0 to +45°C	CB	± 3.0	± 5.0	± 8.0	± 10	± 15	± 20	± 30	± 50	± 100	± 150
0 to +50°C	CC	•	•	•	•	•	•	•	•	•	•
0 to +60°C	CE		•	•	•	•	•	•	•	•	•
0 to +70°C	CG		•	•	•	•	•	•	STD	•	•
-10 to +50°C	EC		•	•	•	•	•	•	•	•	•
-10 to +60°C	EE		•	•	•	•	•	•	•	•	•
-10 to +75°C	EH			•	•	•	•	•	•	•	•
-20 to +70°C	GG			•	•	•	•	•	•	•	•
-20 to +75°C	GH				•	•	•	•	•	•	•
-30 to +75°C	JH				•	•	•	•	•	•	•
-30 to +80°C	JJ				•	•	•	•	•	•	•
-30 to +85°C	JK					•	•	•	•	•	•
-35 to +80°C	KJ					•	•	•	•	•	•
-40 to +85°C	LK					•	•	•	•	•	•
-40 to +90°C	LL					•	•	•	•	•	•
-40 to +105°C	LP						•	•	•	•	•
-40 to +125°C	LU							•	•	•	•

## Legacy Part Number (not for new designs):





SM11T	B	E	-18	-14.31818M	-XX	
<b>Internal code or blank</b>						
<b>Frequency in MHz</b>						
<b>Clload in pF</b> Parallel Resonance from 6 to 32 pF or <b>SR</b> = Series Resonance						
<b>Operating Temperature Range</b> Blank = 0 to + 70°C (STD) <b>E</b> = -40 to +85°C						
<b>Calibration Tolerance / Frequency Stability</b> Blank = 50/50 (STD) <b>B</b> = 30/30 <b>C</b> = 15/30 <b>D</b> = 10/20 (not all frequencies)						
<b>Model Number</b>						

## Reliability: Environmental Compliance

Parameter	Condition
Mechanical Shock	MIL-STD-883 Method 2002, Condition B
Vibration	MIL-STD-883 Method 2007, Condition A
Solderability	MIL-STD-883 Method 2003
Thermal Shock	MIL-STD-883 Method 1011, Condition A

## Package Labeling

Label is 1" x 2.6" (25.4mm x 66.7mm)  
Font is Courier New  
Bar code is 39-Full ASCII

<b>P/N:</b>	
	SM11T-18-24.0M-1SD1EH
<b>Customer P/N:</b>	
	12345678
<b>Qty:</b>	
	1000
<b>D/C</b>	
	0526

Label is 1" x 2.6" (25.4mm x 66.7mm)  
Font is Arial

<b>RoHS Compliant</b>
2nd Lvl Interconnect
Category=e4
Max Safe Temp=260C for 10s 2X Max

## Mechanical:

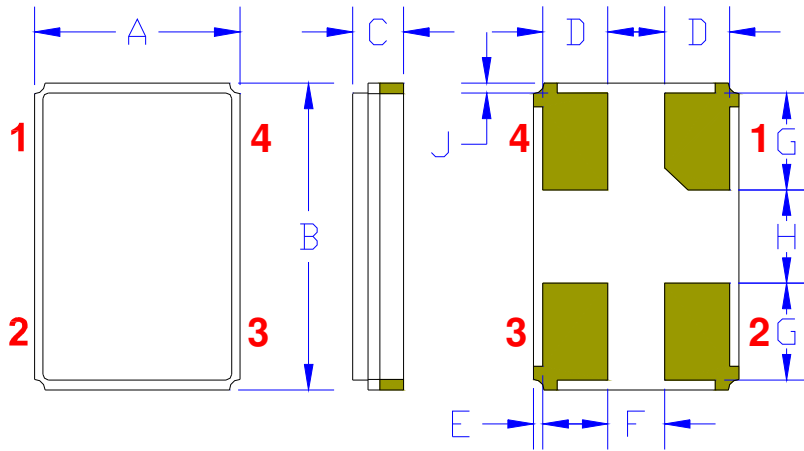

	Inches	mm
A	0.126 ± 0.004	3.2 ± 0.2
B	0.197 ± 0.004	5.0 ± 0.2
C	0.033 max	0.85 max
D <sup>1</sup>	0.031	0.8
E <sup>1</sup>	0.004	0.1
F <sup>1</sup>	0.055	1.4
G <sup>1</sup>	0.043	1.1
H <sup>1</sup>	0.102	2.6
J <sup>1</sup>	0.004	0.1

### Contacts (pads):

Gold 11.8 to 39.3µinches (0.3 to 1.0µm)  
over  
Nickel 50 to 350 µinches (1.27 to 8.89 µm)

**Not to Scale**

<sup>1</sup> Typical dimensions

## Connection (top view):

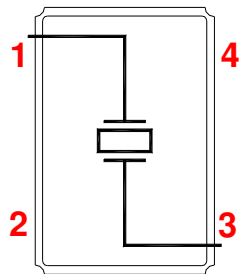

Pad 2 and Pad 4 are common and connected to the metal cover. They are not connected to the crystal.



## Layout and application information

- Trace lengths to the crystal should be kept as short as possible.
- The crystal connections are sensitive to noise.
- The package should be grounded for optimum performance, pad 2 and/or pad 4 connected to ground.

### Part Marking:

**fff.fff M** or **fff.fff M** Where **fff.fff** = frequency in MHz  
**PywwC** or **PymdCz** **Pyww** or **Pymd** = Pletronics and Date code  
**C** = Capacitance load code (see table below)

All other marking is internal factory codes

Specifications such as frequency tolerance and operating temperature range, etc. are not identified from the marking. External packaging labels and packing list will correctly identify the ordered Pletronics part number.

- Orientation of marking may be mixed on the tape
- Traceability of part is lost once removed from reel

Code	A	B	C	D	E	F	G	H	J	K	L	M	N	P	Q	R	S	T	U	V	W	X	Y
pF	10	12	13	8	15	18	20	22	24	26	28	30	32	34	36	27	series	33	50	19	16	17	14

### Codes for Date Code YMD

Code	2	3	4	5	6	7	8
Year	2012	2013	2014	2015	2016	2017	2018

Code	A	B	C	D	E	F	G	H	J	K	L	M
Month	JAN	FEB	MAR	APR	MAY	JUN	JUL	AUG	SEP	OCT	NOV	DEC

Code	1	2	3	4	5	6	7	8	9	A	B	C
Day	1	2	3	4	5	6	7	8	9	10	11	12
Code	D	E	F	G	H	J	K	L	M	N	P	R
Day	13	14	15	16	17	18	19	20	21	22	23	24
Code	T	U	V	W	X	Y	Z					
Day	25	26	27	28	29	30	31					

### Reflow Cycle (typical for lead free processing)

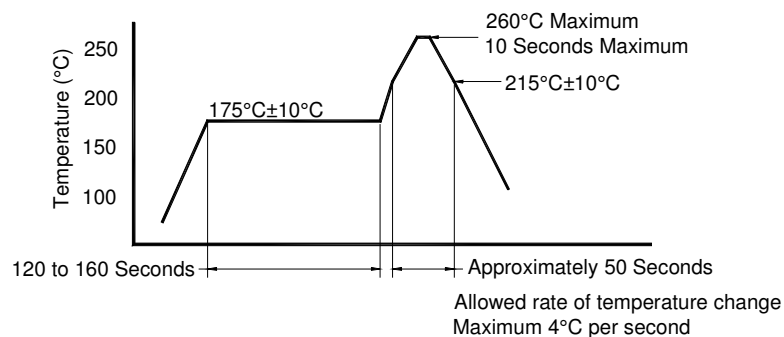

The part may be reflowed 2 times without degradation.

**Tape and Reel: available for quantities of 250 to 3000 per reel**

Constant Dimensions Table 1								
Tape Size	D0	D1 Min	E1	P0	P2	S1 Min	T Max	T1 Max
8mm	1.5	1.0	1.75	4.0	2.0 ±0.05	0.6	0.25	0.1
12mm		1.5			2.0 ±0.1			
16mm	+0.1 -0.0	1.5	±0.1	±0.1	2.0 ±0.1	0.6	0.25	0.1
24mm		1.5						

Variable Dimensions Table 2							
Tape Size	B1 Max	E2 Min	F	P1	T2 Max	W Max	Ao, Bo & Ko
16 mm	12.1	14.25	7.5 ±0.1	8.0 ±0.1	8.0	16.3	Note 1

Note 1: Embossed cavity to conform to EIA-481-B      Dimensions in mm      Not to scale

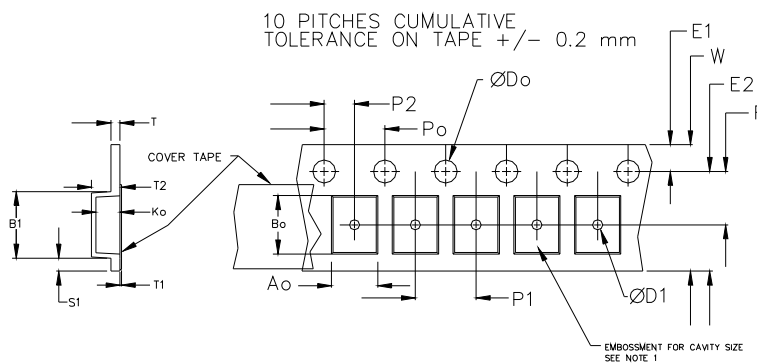
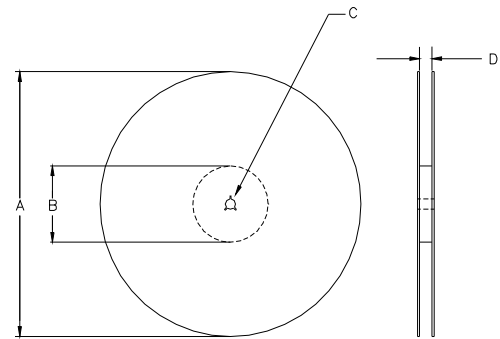

		REEL DIMENSIONS			Tape Width
A	inches	7.0	10.0	13.0	
	mm	177.8	254.0	330.2	
B	inches	2.50	4.00	3.75	16.0
	mm	63.5	101.6	95.3	
C	mm	13.0 +0.5 / -0.2			16.0
D	mm	16.4 +2.0 -0.0	16.4 +2.0 -0.0	16.4 +2.0 -0.0	

Reel dimensions may vary from the above

## IMPORTANT NOTICE

Pletronics Incorporated (PLE) reserves the right to make corrections, improvements, modifications and other changes to this product at anytime. PLE reserves the right to discontinue any product or service without notice. Customers are responsible for obtaining the latest relevant information before placing orders and should verify that such information is current and complete. All products are sold subject to PLE's terms and conditions of sale supplied at the time of order acknowledgment.

PLE warrants performance of this product to the specifications applicable at the time of sale in accordance with PLE's limited warranty. Testing and other quality control techniques are used to the extent PLE deems necessary to support this warranty. Except where mandated by specific contractual documents, testing of all parameters of each product is not necessarily performed.

PLE assumes no liability for application assistance or customer product design. Customers are responsible for their products and applications using PLE components. To minimize the risks associated with the customer products and applications, customers should provide adequate design and operating safeguards.

PLE products are not designed, intended, authorized or warranted to be suitable for use in life support applications, devices or systems or other critical applications that may involve potential risks of death, personal injury or severe property or environmental damage. Inclusion of PLE products in such applications is understood to be fully at the risk of the customer. Use of PLE products in such applications requires the written approval of an appropriate PLE officer. Questions concerning potential risk applications should be directed to PLE.

PLE does not warrant or represent that any license, either express or implied, is granted under any PLE patent right, copyright, artwork or other intellectual property right relating to any combination, machine or process which PLE product or services are used. Information published by PLE regarding third-party products or services does not constitute a license from PLE to use such products or services or a warranty or endorsement thereof. Use of such information may require a license from a third party under the patents or other intellectual property of the third party, or a license from PLE under the patents or other intellectual property of PLE.

Reproduction of information in PLE data sheets or web site is permissible only if the reproduction is without alteration and is accompanied by associated warranties, conditions, limitations and notices. Reproduction of this information with alteration is an unfair and deceptive business practice. PLE is not responsible or liable for such altered documents.

Resale of PLE products or services with statements different from or beyond the parameters stated by PLE for that product or service voids all express and implied warranties for the associated PLE product or service and is an unfair or deceptive business practice. PLE is not responsible for any such statements.

### Contacting Pletronics Inc.

Pletronics Inc.  
19013 36<sup>th</sup> Ave. West  
Lynnwood, WA 98036-5761 USA

Tel: 425-776-1880  
Fax: 425-776-2760  
E-mail: [ple-sales@pletronics.com](mailto:ple-sales@pletronics.com)  
URL: [www.pletronics.com](http://www.pletronics.com)

Copyright © 2006, 2007, 2010 Pletronics Inc.



Компания «ЭлектроПласт» предлагает заключение долгосрочных отношений при поставках импортных электронных компонентов на взаимовыгодных условиях!

Наши преимущества:

- Оперативные поставки широкого спектра электронных компонентов отечественного и импортного производства напрямую от производителей и с крупнейших мировых складов;
- Поставка более 17-ти миллионов наименований электронных компонентов;
- Поставка сложных, дефицитных, либо снятых с производства позиций;
- Оперативные сроки поставки под заказ (от 5 рабочих дней);
- Экспресс доставка в любую точку России;
- Техническая поддержка проекта, помощь в подборе аналогов, поставка прототипов;
- Система менеджмента качества сертифицирована по Международному стандарту ISO 9001;
- Лицензия ФСБ на осуществление работ с использованием сведений, составляющих государственную тайну;
- Поставка специализированных компонентов (Xilinx, Altera, Analog Devices, Intersil, Interpoint, Microsemi, Aeroflex, Peregrine, Syfer, Eurofarad, Texas Instrument, Miteq, Cobham, E2V, MA-COM, Hittite, Mini-Circuits, General Dynamics и др.);

Помимо этого, одним из направлений компании «ЭлектроПласт» является направление «Источники питания». Мы предлагаем Вам помощь Конструкторского отдела:

- Подбор оптимального решения, техническое обоснование при выборе компонента;
- Подбор аналогов;
- Консультации по применению компонента;
- Поставка образцов и прототипов;
- Техническая поддержка проекта;
- Защита от снятия компонента с производства.



#### Как с нами связаться

**Телефон:** 8 (812) 309 58 32 (многоканальный)

**Факс:** 8 (812) 320-02-42

**Электронная почта:** [org@eplast1.ru](mailto:org@eplast1.ru)

**Адрес:** 198099, г. Санкт-Петербург, ул. Калинина, дом 2, корпус 4, литера А.