

HIGH SENSITIVITY MICROPOWER OMNIPOLAR HALL-EFFECT SWITCH

NEW PRODUCT

Description

The AH1812 is a high sensitivity micropower Omnipolar Hall effect switch IC with an open drain output. Designed for portable and battery powered equipment such as cellular phones and portable PCs, the average supply current is only 4.3µA at 1.85V. To support portable equipment the AH1812 can operate over the supply range of 1.6V to 3.6V and uses a hibernating clocking system to minimize the power consumption. To minimize PCB space the AH1812 is available in small low profile X1-DFN1216-4 package

The open drain output is activated with either a North or South pole of sufficient magnetic field strength. When the magnetic flux density (B) perpendicular to the package is larger than operate point (Bop), the output will be turned on (pulled low). The output is turned off when B becomes lower than the release point (Brp). The output will remain off when there is no magnetic field.

Features

- Omnipolar Operation (North or South Pole)
- Supply Voltage of 1.6V to 3.6V
- High Sensitivity
- Micropower Operation
- Chopper Stabilized Design Provides:
 - Superior Temperature Stability
 - Extremely Low Switch-Point Drift
 - Enhanced Immunity to Stress
- Open Drain Output for System Flexibility
- Good RF Noise Immunity
- -40°C to +85°C Operating Temperature
- Small and Low Profile X1-DFN1216-4 Package
- **Totally Lead-Free & Fully RoHS Compliant (Notes 1 & 2)**
- **Halogen and Antimony Free. "Green" Device (Note 3)**

Pin Assignments

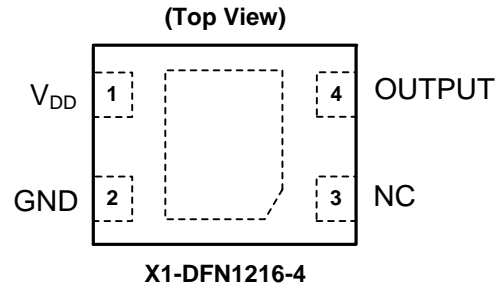

Applications

- Cover or Display Switch in Portable PCs
- Open and Close Detect for Cellular Phones
- Holster Detect for Cellular Phones and Tablet PCs
- Digital Still and Video Cameras
- Contact-Less Switches

Notes: 1. No purposely added lead. Fully EU Directive 2002/95/EC (RoHS) & 2011/65/EU (RoHS 2) compliant.
 2. See http://www.diodes.com/quality/lead_free.html for more information about Diodes Incorporated's definitions of Halogen- and Antimony-free, "Green" and Lead-free.
 3. Halogen- and Antimony-free "Green" products are defined as those which contain <900ppm bromine, <900ppm chlorine (<1500ppm total Br + Cl) and <1000ppm antimony compounds.

Typical Applications Circuit (Note 4)

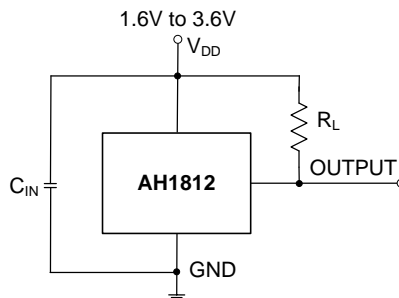

Note: 4. CIN is for power stabilization and to strengthen the noise immunity, the recommended capacitance is 10nF to 100nF. RL is the pull-up resistor, the recommended resistance is 10kΩ to 100kΩ.

Pin Descriptions

Package: X1-DFN1216-4

Pin Number	Pin Name	Function
1	V _{DD}	Power Supply Input
2	GND	Ground Pin
3	NC	No Connection (Note 5)
4	OUTPUT	Output Pin
Pad	Pad	Can be connected to GND or left open circuit

Note: 5. NC is "No Connection" pin and is not connected internally. This pin can be left open or tied to ground.

Functional Block Diagram

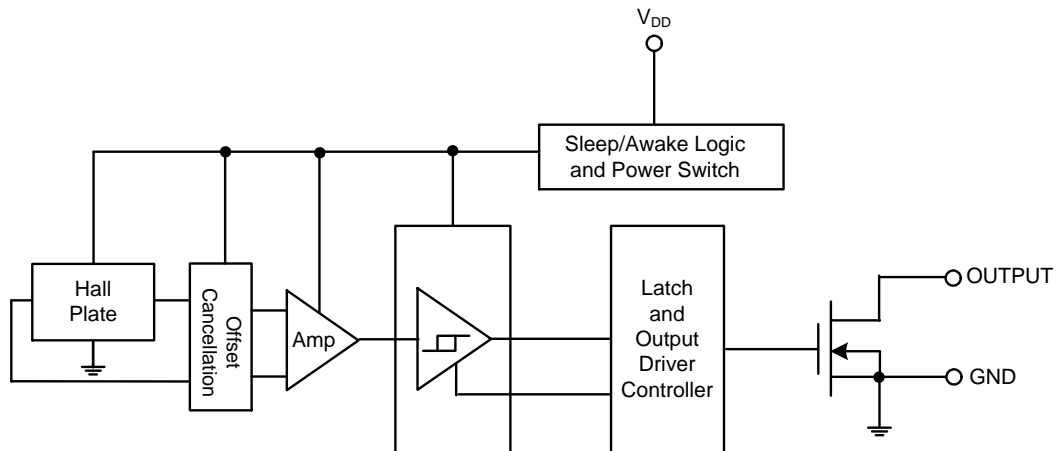

Absolute Maximum Ratings (Note 6) (@T_A = +25°C, unless otherwise specified.)

Symbol	Characteristics	Values	Unit
V _{DD}	Supply Voltage (Note 7)	6	V
V _{DD_REV}	Reverse Supply Voltage	-0.3	V
I _{OUTPUT}	Output current (source and sink)	2	mA
B	Magnetic Flux Density	Unlimited	
P _D	Package Power Dissipation	X1-DFN1216-4	230 mW
T _s	Storage Temperature Range	+150	°C
T _J	Maximum Junction Temperature	150	°C
ESD HBM	Human Body Model ESD capability	4	kV

- Notes:
- Stresses greater than the 'Absolute Maximum Ratings' specified above may cause permanent damage to the device. These are stress ratings only; functional operation of the device at these or any other conditions exceeding those indicated in this specification is not implied. Device reliability may be affected by exposure to absolute maximum rating conditions for extended periods of time.
 - The absolute maximum V_{DD} of 6V is a transient stress rating and is not meant as a functional operating condition. It is not recommended to operate the device at the absolute maximum rated conditions for any period of time.

Recommended Operating Conditions (@T_A = +25°C, unless otherwise specified.)

Symbol	Characteristic	Conditions	Rating	Unit
V _{DD}	Supply Voltage	Operating	1.6 to 3.6	V
T _A	Operating Temperature Range	Operating	-40 to +85	°C

Electrical Characteristics (@T_A = +25°C, V_{DD} = 3V, unless otherwise specified.)

Symbol	Characteristic	Conditions	Min	Typ	Max	Unit
V _{OUT}	Output Low Voltage (on)	I _{OUT} = 1mA	—	0.1	0.2	V
I _{off}	Output leakage current	V _{out} =3.6V, B < Brps	—	<0.1	1	µA
I _{DD(awake)}	Supply Current	During 'awake' period	—	2.3	—	mA
I _{DD(sleep)}		During 'sleep' period	—	2.5	—	µA
I _{DD(avg)}	Average Supply Current	V _{DD} = 1.85V	—	4.3	8	µA
I _{DD(avg)}		V _{DD} = 3.0V	—	6	10	µA
T _{awake}	Awake Active Pulse Width	(Note 8)	—	50	100	µs
T _{period}	Awake Period	(Note 8)	—	50	100	ms
D.C.	Duty Cycle		—	0.1	—	%

- Note:
- When power is initially turned on, the operating V_{DD} (1.6V to 3.6V) must be applied to guaranteed the output sampling. The output state is valid after the second operating cycle (typical 100ms).

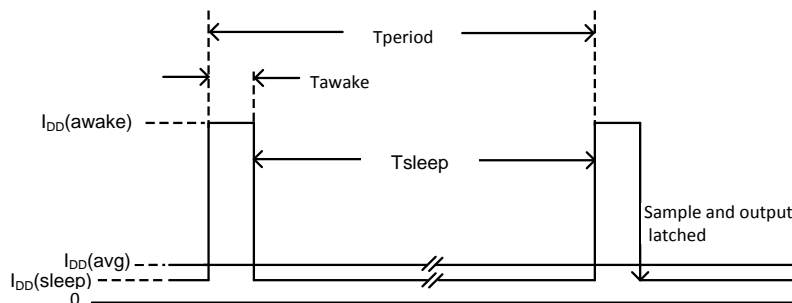

Magnetic Characteristics (Note 9) (@ $T_A = +25^\circ\text{C}$, $V_{DD} = 3\text{V}$, unless otherwise specified.)

(1mT=10 Gauss)

Symbol	Characteristic	Min	Typ	Max	Unit
Bops (south pole to part marking side)	Operation Point	16	30	40	Gauss
Bopn (north pole to part marking side)		-40	-30	-16	
Brps (south pole to part marking side)	Release Point	11	20	35	
Brpn (north pole to part marking side)		-35	-20	-11	
Bhy ($ B_{opx} - B_{rpx} $)	Hysteresis	-	10	-	

Note: 9. The magnetic characteristics may vary with supply voltage, operating temperature and after soldering.

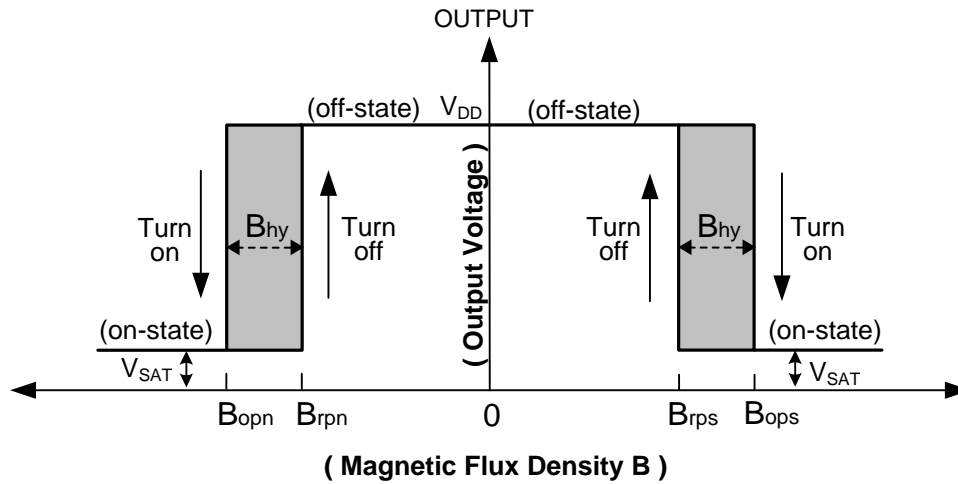

Typical Operating Characteristics

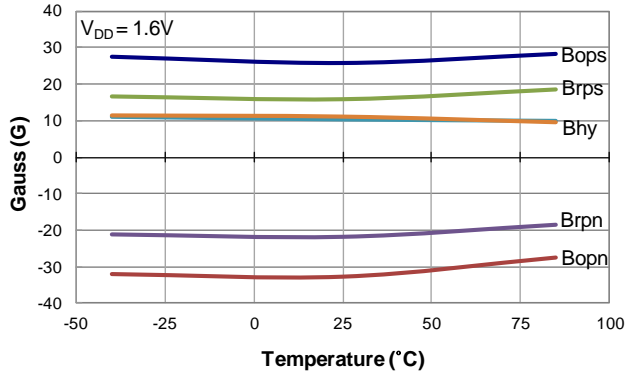

Switch Points vs Temperature

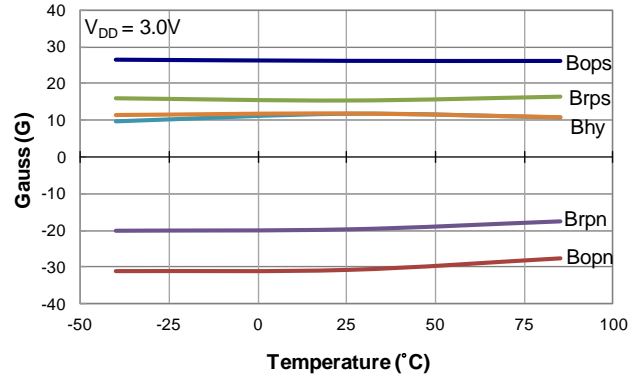

Switch Points vs Temperature

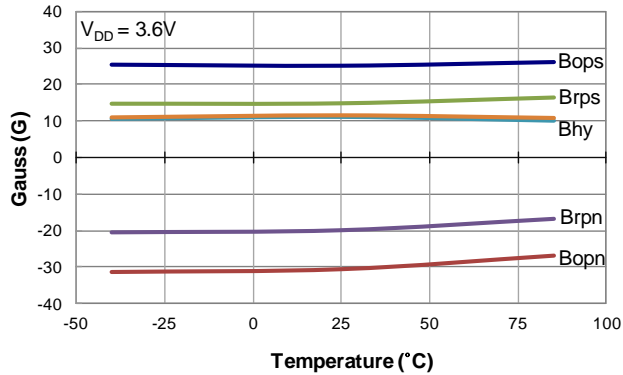

Switch Points vs Temperature

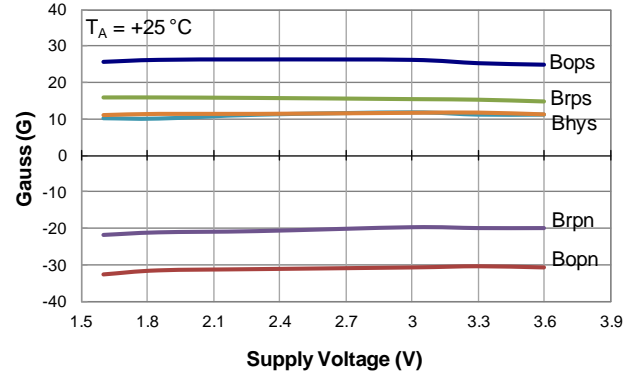

Switch Points vs Supply Voltage

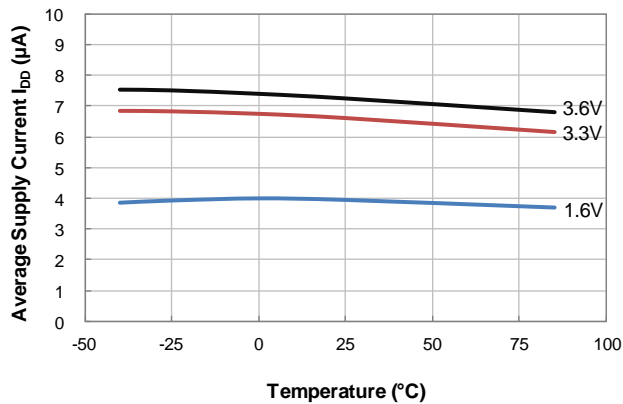

Average Supply Current vs. Temperature

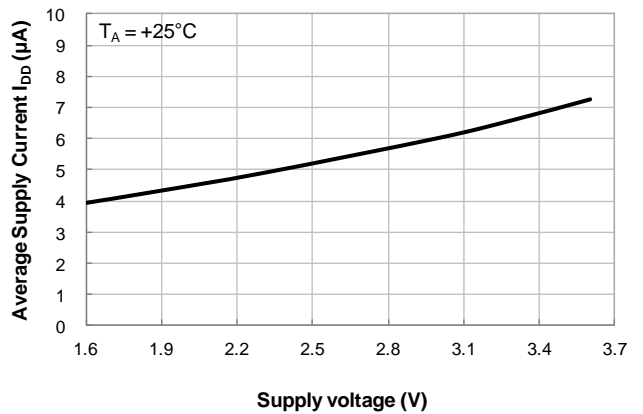

Average Supply Current vs. Supply Voltage

Ordering Information

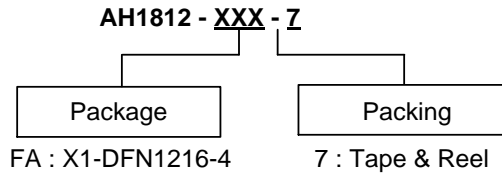

Part Number	Package Code	Packaging	7" Tape and Reel	
			Quantity	Part Number Suffix
AH1812-FA-7	FA	X1-DFN1216-4	3000/Tape & Reel	-7

Marking Information

(1) Package Type: X1-DFN1216-4

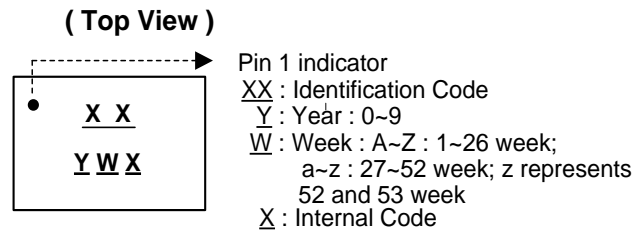

Part Number	Package	Identification Code
AH1812-FA-7	X1-DFN1216-4	H2

Package Outline Dimensions (All dimensions in mm.)

Please see AP02002 at <http://www.diodes.com/datasheets/ap02002.pdf> for latest version.

(1) Package Type: X1-DFN1216-4

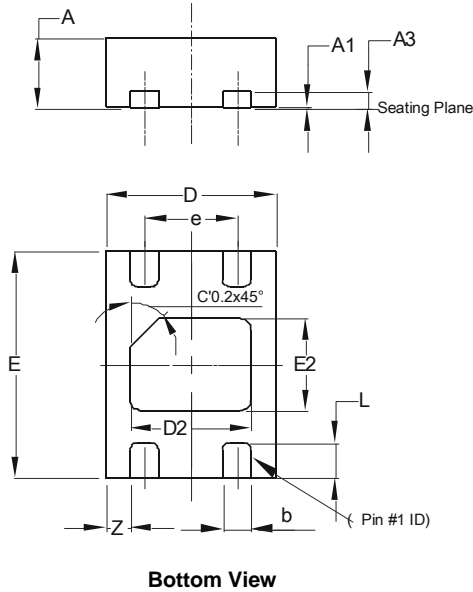

X1-DFN1216-4			
Dim	Min	Max	Typ
A	0.47	0.53	0.50
A1	0.00	0.05	0.02
A3	--	--	0.13
b	0.15	0.25	0.20
D	1.15	1.25	1.20
D2	0.75	0.95	0.85
E	1.55	1.65	1.60
E2	0.55	0.75	0.65
e	-	-	0.65
L	0.20	0.30	0.25
Z	-	-	0.175
All Dimensions in mm			

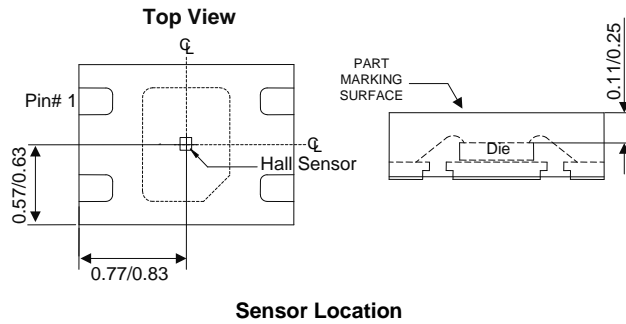

Suggested Pad Layout (All dimensions in mm.)

Please see AP02001 at <http://www.diodes.com/datasheets/ap02001.pdf> for latest version.

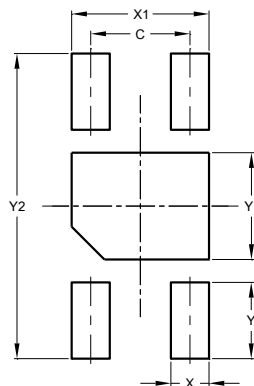

X1-DFN1216-4	
Dimensions	Value
C	0.65
X	0.25
X1	0.90
Y	0.50
Y1	0.70
Y2	2.00
All Dimensions in mm	

IMPORTANT NOTICE

DIODES INCORPORATED MAKES NO WARRANTY OF ANY KIND, EXPRESS OR IMPLIED, WITH REGARDS TO THIS DOCUMENT, INCLUDING, BUT NOT LIMITED TO, THE IMPLIED WARRANTIES OF MERCHANTABILITY AND FITNESS FOR A PARTICULAR PURPOSE (AND THEIR EQUIVALENTS UNDER THE LAWS OF ANY JURISDICTION).

Diodes Incorporated and its subsidiaries reserve the right to make modifications, enhancements, improvements, corrections or other changes without further notice to this document and any product described herein. Diodes Incorporated does not assume any liability arising out of the application or use of this document or any product described herein; neither does Diodes Incorporated convey any license under its patent or trademark rights, nor the rights of others. Any Customer or user of this document or products described herein in such applications shall assume all risks of such use and will agree to hold Diodes Incorporated and all the companies whose products are represented on Diodes Incorporated website, harmless against all damages.

Diodes Incorporated does not warrant or accept any liability whatsoever in respect of any products purchased through unauthorized sales channel. Should Customers purchase or use Diodes Incorporated products for any unintended or unauthorized application, Customers shall indemnify and hold Diodes Incorporated and its representatives harmless against all claims, damages, expenses, and attorney fees arising out of, directly or indirectly, any claim of personal injury or death associated with such unintended or unauthorized application.

Products described herein may be covered by one or more United States, international or foreign patents pending. Product names and markings noted herein may also be covered by one or more United States, international or foreign trademarks.

This document is written in English but may be translated into multiple languages for reference. Only the English version of this document is the final and determinative format released by Diodes Incorporated.

LIFE SUPPORT

Diodes Incorporated products are specifically not authorized for use as critical components in life support devices or systems without the express written approval of the Chief Executive Officer of Diodes Incorporated. As used herein:

A. Life support devices or systems are devices or systems which:

1. are intended to implant into the body, or
2. support or sustain life and whose failure to perform when properly used in accordance with instructions for use provided in the labeling can be reasonably expected to result in significant injury to the user.

B. A critical component is any component in a life support device or system whose failure to perform can be reasonably expected to cause the failure of the life support device or to affect its safety or effectiveness.

Customers represent that they have all necessary expertise in the safety and regulatory ramifications of their life support devices or systems, and acknowledge and agree that they are solely responsible for all legal, regulatory and safety-related requirements concerning their products and any use of Diodes Incorporated products in such safety-critical, life support devices or systems, notwithstanding any devices- or systems-related information or support that may be provided by Diodes Incorporated. Further, Customers must fully indemnify Diodes Incorporated and its representatives against any damages arising out of the use of Diodes Incorporated products in such safety-critical, life support devices or systems.

Copyright © 2013, Diodes Incorporated

www.diodes.com



Компания «ЭлектроПласт» предлагает заключение долгосрочных отношений при поставках импортных электронных компонентов на взаимовыгодных условиях!

Наши преимущества:

- Оперативные поставки широкого спектра электронных компонентов отечественного и импортного производства напрямую от производителей и с крупнейших мировых складов;
- Поставка более 17-ти миллионов наименований электронных компонентов;
- Поставка сложных, дефицитных, либо снятых с производства позиций;
- Оперативные сроки поставки под заказ (от 5 рабочих дней);
- Экспресс доставка в любую точку России;
- Техническая поддержка проекта, помощь в подборе аналогов, поставка прототипов;
- Система менеджмента качества сертифицирована по Международному стандарту ISO 9001;
- Лицензия ФСБ на осуществление работ с использованием сведений, составляющих государственную тайну;
- Поставка специализированных компонентов (Xilinx, Altera, Analog Devices, Intersil, Interpoint, Microsemi, Aeroflex, Peregrine, Syfer, Eurofarad, Texas Instrument, Miteq, Cobham, E2V, MA-COM, Hittite, Mini-Circuits, General Dynamics и др.);

Помимо этого, одним из направлений компании «ЭлектроПласт» является направление «Источники питания». Мы предлагаем Вам помощь Конструкторского отдела:

- Подбор оптимального решения, техническое обоснование при выборе компонента;
- Подбор аналогов;
- Консультации по применению компонента;
- Поставка образцов и прототипов;
- Техническая поддержка проекта;
- Защита от снятия компонента с производства.



Как с нами связаться

Телефон: 8 (812) 309 58 32 (многоканальный)

Факс: 8 (812) 320-02-42

Электронная почта: org@eplast1.ru

Адрес: 198099, г. Санкт-Петербург, ул. Калинина, дом 2, корпус 4, литера А.