



32, 35, L32 Series Pressfit Indicator Light for 1/2" Diameter Mounting Hole



- NEON, LED & INCANDESCENT
- 2 TO 600 DESIGN VOLTS
- 6" WIRE LEADS & 3/16" TAB TERMINALS
- VARIETY OF LENS COLORS
- cULus CERTIFIED (UL FILE E20356)
- QUICK DISCONNECT TERMINAL CE CERTIFIED

Overview

The 32/35 Series Indicators feature a wide variety of lenses, colors, voltage & bezel variations. Indicators quickly pressfit into a 0.500" to 0.510" mounting hole with recommended panel thickness range of 0.020" min. to 0.090" max.

Specifications

Housing: White nylon. A black housing is available.

Bezel: Nickel plated brass. A black anodized bezel is available.

Lens: polycarbonate.

Incandescent AC or DC voltage options: 6, 14 and 28 volts.

Neon AC or DC voltage options: 125 and 250 and 600 volts.

Note: high brightness green and blue neon lamps supplied in green and blue neon applications.

Led DC voltage options: 2, 6, 12, 24 volts.

Led AC voltage options: 125 volts.

Note: 125 volts AC units contain a bi-polar LED.
LED versions are not CE Certified.

Two 6" wire leads: #20 AWG, black, bare copper, PVC insulated, UL/CSA rated 105 °C, 600 V, UL style 1015, stripped 1/2". For DC LED units, wire leads are color-coded red and black; the red wire lead denotes the anode (+) while a black wire lead identifies the cathode (-). For AC LED units, wire leads are white. Custom wire lengths, stripping, termination and wire type are available.

Terminals:

3/16 tabs: Brass, (0.187" length x 0.020" thick). For LED units, a tin plated terminal denotes the anode (+). 1/4" or 1/8" brass tab terminals are available.

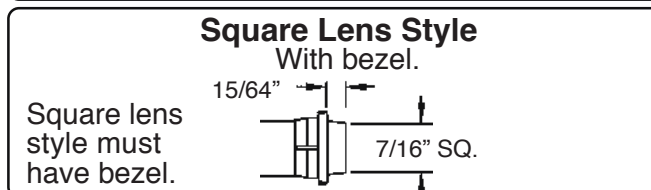
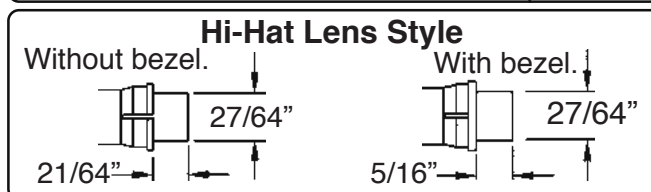
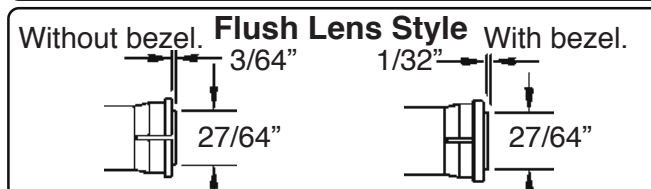
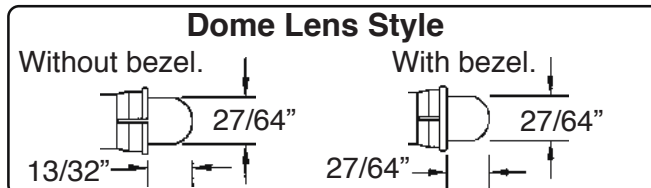
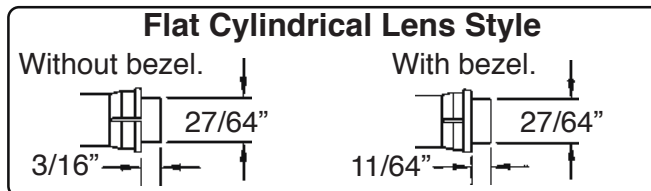
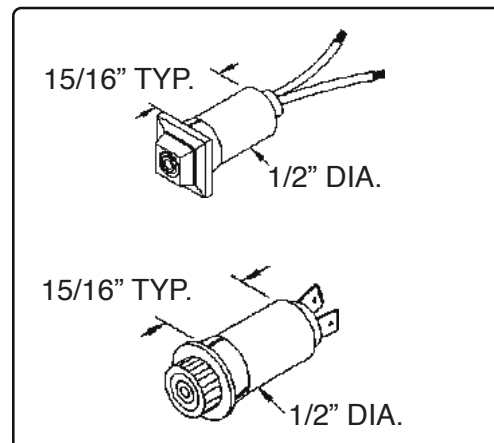

Flat Cylindrical Lens without Bezel - Neon or Incandescent



Flat Cylindrical Style
Without bezel.

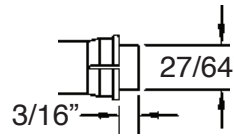

Part Number 6" Wire Leads	Part Number 3/16" Tab Terminals	Lens Color	Lamp Type	Design Volts	Design Watts or Amps	Life (hrs)
32-2111	32-2111T	Red	Neon	125	1/3W	25,000
35-2111	35-2111T	Red	Neon	250	1/3W	25,000
32G1-2111	32G1-2111T	Red	Incandescent	6	.20A	5,000
32G3-2111	32G3-2111T	Red	Incandescent	14	.10A	10,000
32G18-2111	32G18-2111T	Red	Incandescent	28	.04A	7,000
32-2112	32-2112T	Green	Neon	125	1/3W	25,000
35-2112	35-2112T	Green	Neon	250	1/3W	25,000
32G1-2112	32G1-2112T	Green	Incandescent	6	.20A	5,000
32G3-2112	32G3-2112T	Green	Incandescent	14	.10A	10,000
32G18-2112	32G18-2112T	Green	Incandescent	28	.04A	7,000
32-2113	32-2113T	Amber	Neon	125	1/3W	25,000
35-2113	35-2113T	Amber	Neon	250	1/3W	25,000
32G1-2113	32G1-2113T	Amber	Incandescent	6	.20A	5,000
32G3-2113	32G3-2113T	Amber	Incandescent	14	.10A	10,000
32G18-2113	32G18-2113T	Amber	Incandescent	28	.04A	7,000
32-2114	32-2114T	Blue	Neon	125	1/3W	25,000
35-2114	35-2114T	Blue	Neon	250	1/3W	25,000
32G1-2114	32G1-2114T	Blue	Incandescent	6	.20A	5,000
32G3-2114	32G3-2114T	Blue	Incandescent	14	.10A	10,000
32G18-2114	32G18-2114T	Blue	Incandescent	28	.04A	7,000
32-2115	32-2115T	White	Neon	125	1/3W	25,000
35-2115	35-2115T	White	Neon	250	1/3W	25,000
32G1-2115	32G1-2115T	White	Incandescent	6	.20A	5,000
32G3-2115	32G3-2115T	White	Incandescent	14	.10A	10,000
32G18-2115	32G18-2115T	White	Incandescent	28	.04A	7,000
32-2117	32-2117T	Clear	Neon	125	1/3W	25,000
32-2117	32-2117T	Clear	Neon	250	1/3W	25,000
32G1-2117	32G1-2117T	Clear	Incandescent	6	.20A	5,000
32G3-2117	32G3-2117T	Clear	Incandescent	14	.10A	10,000
32G18-2117	32G18-2117T	Clear	Incandescent	28	.04A	7,000

Flat Cylindrical Lens Nickel Plated Bezel - Neon or Incandescent



Flat Cylindrical Lens Style
With bezel.



Part Number 6" Wire Leads	Part Number 3/16" Tab Terminals	Lens Color	Lamp Type	Design Volts	Design Watts or Amps	Life (hrs)
32R-2111	32R-2111T	Red	Neon	125	1/3W	25,000
35R-2111	35R-2111T	Red	Neon	250	1/3W	25,000
32RG1-2111	32RG1-2111T	Red	Incandescent	6	.20A	5,000
32RG3-2111	32RG3-2111T	Red	Incandescent	14	.10A	10,000
32RG18-2111	32RG18-2111T	Red	Incandescent	28	.04A	7,000
32R-2112	32R-2112T	Green	Neon	125	1/3W	25,000
35R-2112	35R-2112T	Green	Neon	250	1/3W	25,000
32RG1-2112	32RG1-2112T	Green	Incandescent	6	.20A	5,000
32RG3-2112	32RG3-2112T	Green	Incandescent	14	.10A	10,000
32RG18-2112	32RG18-2112T	Green	Incandescent	28	.04A	7,000
32R-2113	32R-2113T	Amber	Neon	125	1/3W	25,000
35R-2113	35R-2113T	Amber	Neon	250	1/3W	25,000
32RG1-2113	32RG1-2113T	Amber	Incandescent	6	.20A	5,000
32RG3-2113	32RG3-2113T	Amber	Incandescent	14	.10A	10,000
32RG18-2113	32RG18-2113T	Amber	Incandescent	28	.04A	7,000
32R-2114	32R-2114T	Blue	Neon	125	1/3W	25,000
35R-2114	35R-2114T	Blue	Neon	250	1/3W	25,000
32RG1-2114	32RG1-2114T	Blue	Incandescent	6	.20A	5,000
32RG3-2114	32RG3-2114T	Blue	Incandescent	14	.10A	10,000
32RG18-2114	32RG18-2114T	Blue	Incandescent	28	.04A	7,000
32R-2115	32R-2115T	White	Neon	125	1/3W	25,000
35R-2115	35R-2115T	White	Neon	250	1/3W	25,000
32RG1-2115	32RG1-2115T	White	Incandescent	6	.20A	5,000
32RG3-2115	32RG3-2115T	White	Incandescent	14	.10A	10,000
32RG18-2115	32RG18-2115T	White	Incandescent	28	.04A	7,000
32R-2117	32R-2117T	Clear	Neon	125	1/3W	25,000
32R-2117	32R-2117T	Clear	Neon	250	1/3W	25,000
32RG1-2117	32RG1-2117T	Clear	Incandescent	6	.20A	5,000
32RG3-2117	32RG3-2117T	Clear	Incandescent	14	.10A	10,000
32RG18-2117	32RG18-2117T	Clear	Incandescent	28	.04A	7,000

Dome Lens without Bezel - Neon or Incandescent



Dome Lens Style
Without bezel.

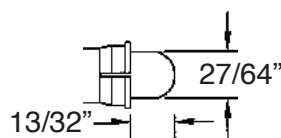

Part Number 6" Wire Leads	Part Number 3/16" Tab Terminals	Lens Color	Lamp Type	Design Volts	Design Watts or Amps	Life (hrs)
32-2211	32-2211T	Red	Neon	125	1/3W	25,000
35-2211	35-2211T	Red	Neon	250	1/3W	25,000
32G1-2211	32G1-2211T	Red	Incandescent	6	.20A	5,000
32G3-2211	32G3-2211T	Red	Incandescent	14	.10A	10,000
32G18-2211	32G18-2211T	Red	Incandescent	28	.04A	7,000
32-2212	32-2212T	Green	Neon	125	1/3W	25,000
35-2212	35-2212T	Green	Neon	250	1/3W	25,000
32G1-2212	32G1-2212T	Green	Incandescent	6	.20A	5,000
32G3-2212	32G3-2212T	Green	Incandescent	14	.10A	10,000
32G18-2212	32G18-2212T	Green	Incandescent	28	.04A	7,000
32-2213	32-2213T	Amber	Neon	125	1/3W	25,000
35-2213	35-2213T	Amber	Neon	250	1/3W	25,000
32G1-2213	32G1-2213T	Amber	Incandescent	6	.20A	5,000
32G3-2213	32G3-2213T	Amber	Incandescent	14	.10A	10,000
32G18-2213	32G18-2213T	Amber	Incandescent	28	.04A	7,000
32-2214	32-2214T	Blue	Neon	125	1/3W	25,000
35-2214	35-2214T	Blue	Neon	250	1/3W	25,000
32G1-2214	32G1-2214T	Blue	Incandescent	6	.20A	5,000
32G3-2214	32G3-2214T	Blue	Incandescent	14	.10A	10,000
32G18-2214	32G18-2214T	Blue	Incandescent	28	.04A	7,000
32-2215	32-2215T	White	Neon	125	1/3W	25,000
35-2215	35-2215T	White	Neon	250	1/3W	25,000
32G1-2215	32G1-2215T	White	Incandescent	6	.20A	5,000
32G3-2215	32G3-2215T	White	Incandescent	14	.10A	10,000
32G18-2215	32G18-2215T	White	Incandescent	28	.04A	7,000
32-2217	32-2217T	Clear	Neon	125	1/3W	25,000
32-2217	32-2217T	Clear	Neon	250	1/3W	25,000
32G1-2217	32G1-2217T	Clear	Incandescent	6	.20A	5,000
32G3-2217	32G3-2217T	Clear	Incandescent	14	.10A	10,000
32G18-2217	32G18-2217T	Clear	Incandescent	28	.04A	7,000

Dome Lens Nickel Plated Bezel - Neon or Incandescent

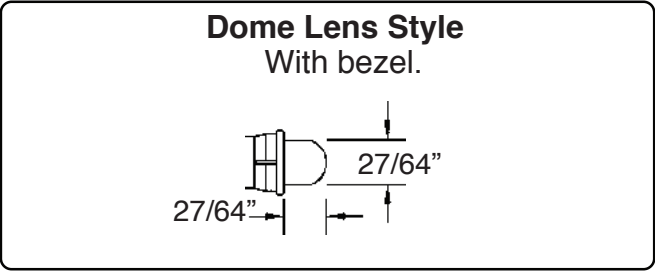

Part Number 6" Wire Leads	Part Number 3/16" Tab Terminals	Lens Color	Lamp Type	Design Volts	Design Watts or Amps	Life (hrs)
32R-2211	32R-2211T	Red	Neon	125	1/3W	25,000
35R-2211	35R-2211T	Red	Neon	250	1/3W	25,000
32RG1-2211	32RG1-2211T	Red	Incandescent	6	.20A	5,000
32RG3-2211	32RG3-2211T	Red	Incandescent	14	.10A	10,000
32RG18-2211	32RG18-2211T	Red	Incandescent	28	.04A	7,000
32R-2212	32R-2212T	Green	Neon	125	1/3W	25,000
35R-2212	35R-2212T	Green	Neon	250	1/3W	25,000
32RG1-2212	32RG1-2212T	Green	Incandescent	6	.20A	5,000
32RG3-2212	32RG3-2212T	Green	Incandescent	14	.10A	10,000
32RG18-2212	32RG18-2212T	Green	Incandescent	28	.04A	7,000
32R-2213	32R-2213T	Amber	Neon	125	1/3W	25,000
35R-2213	35R-2213T	Amber	Neon	250	1/3W	25,000
32RG1-2213	32RG1-2213T	Amber	Incandescent	6	.20A	5,000
32RG3-2213	32RG3-2213T	Amber	Incandescent	14	.10A	10,000
32RG18-2213	32RG18-2213T	Amber	Incandescent	28	.04A	7,000
32R-2214	32R-2214T	Blue	Neon	125	1/3W	25,000
35R-2214	35R-2214T	Blue	Neon	250	1/3W	25,000
32RG1-2214	32RG1-2214T	Blue	Incandescent	6	.20A	5,000
32RG3-2214	32RG3-2214T	Blue	Incandescent	14	.10A	10,000
32RG18-2214	32RG18-2214T	Blue	Incandescent	28	.04A	7,000
32R-2215	32R-2215T	White	Neon	125	1/3W	25,000
35R-2215	35R-2215T	White	Neon	250	1/3W	25,000
32RG1-2215	32RG1-2215T	White	Incandescent	6	.20A	5,000
32RG3-2215	32RG3-2215T	White	Incandescent	14	.10A	10,000
32RG18-2215	32RG18-2215T	White	Incandescent	28	.04A	7,000
32R-2217	32R-2217T	Clear	Neon	125	1/3W	25,000
32R-2217	32R-2217T	Clear	Neon	250	1/3W	25,000
32RG1-2217	32RG1-2217T	Clear	Incandescent	6	.20A	5,000
32RG3-2217	32RG3-2217T	Clear	Incandescent	14	.10A	10,000
32RG18-2217	32RG18-2217T	Clear	Incandescent	28	.04A	7,000

Flush Lens without Bezel - Neon or Incandescent

Flush Lens Style Without bezel.



Part Number 6" Wire Leads	Part Number 3/16" Tab Terminals	Lens Color	Lamp Type	Design Volts	Design Watts or Volts	Life (hrs)
32-2311	32-2311T	Red	Neon	125	1/3W	25,000
35-2311	35-2311T	Red	Neon	250	1/3W	25,000
32G1-2311	32G1-2311T	Red	Incandescent	6	.20A	5,000
32G3-2311	32G3-2311T	Red	Incandescent	14	.10A	10,000
32G18-2311	32G18-2311T	Red	Incandescent	28	.04A	7,000
32-2312	32-2312T	Green	Neon	125	1/3W	25,000
35-2312	35-2312T	Green	Neon	250	1/3W	25,000
32G1-2312	32G1-2312T	Green	Incandescent	6	.20A	5,000
32G3-2312	32G3-2312T	Green	Incandescent	14	.10A	10,000
32G18-2312	32G18-2312T	Green	Incandescent	28	.04A	7,000
32-2313	32-2313T	Amber	Neon	125	1/3W	25,000
35-2313	35-2313T	Amber	Neon	250	1/3W	25,000
32G1-2313	32G1-2313T	Amber	Incandescent	6	.20A	5,000
32G3-2313	32G3-2313T	Amber	Incandescent	14	.10A	10,000
32G18-2313	32G18-2313T	Amber	Incandescent	28	.04A	7,000
32-2314	32-2314T	Blue	Neon	125	1/3W	25,000
35-2314	35-2314T	Blue	Neon	250	1/3W	25,000
32G1-2314	32G1-2314T	Blue	Incandescent	6	.20A	5,000
32G3-2314	32G3-2314T	Blue	Incandescent	14	.10A	10,000
32G18-2314	32G18-2314T	Blue	Incandescent	28	.04A	7,000
32-2315	32-2315T	White	Neon	125	1/3W	25,000
35-2315	35-2315T	White	Neon	250	1/3W	25,000
32G1-2315	32G1-2315T	White	Incandescent	6	.20A	5,000
32G3-2315	32G3-2315T	White	Incandescent	14	.10A	10,000
32G18-2315	32G18-2315T	White	Incandescent	28	.04A	7,000
32-2317	32-2317T	Clear	Neon	125	1/3W	25,000
32-2317	32-2317T	Clear	Neon	250	1/3W	25,000
32G1-2317	32G1-2317T	Clear	Incandescent	6	.20A	5,000
32G3-2317	32G3-2317T	Clear	Incandescent	14	.10A	10,000
32G18-2317	32G18-2317T	Clear	Incandescent	28	.04A	7,000

Flush Lens Nickel Plated Bezel - Neon or Incandescent



Flush Lens Style
Without bezel.

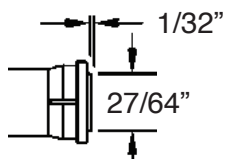

Part Number 6" Wire Leads	Part Number 3/16" Tab Terminals	Lens Color	Lamp Type	Design Volts	Design Watts or Amps	Life (hrs)
32R-2311	32R-2311T	Red	Neon	125	1/3W	25,000
35R-2311	35R-2311T	Red	Neon	250	1/3W	25,000
32RG1-2311	32RG1-2311T	Red	Incandescent	6	.20A	5,000
32RG3-2311	32RG3-2311T	Red	Incandescent	14	.10A	10,000
32RG18-2311	32RG18-2311T	Red	Incandescent	28	.04A	7,000
32R-2312	32R-2312T	Green	Neon	125	1/3W	25,000
35R-2312	35R-2312T	Green	Neon	250	1/3W	25,000
32RG1-2312	32RG1-2312T	Green	Incandescent	6	.20A	5,000
32RG3-2312	32RG3-2312T	Green	Incandescent	14	.10A	10,000
32RG18-2312	32RG18-2312T	Green	Incandescent	28	.04A	7,000
32R-2313	32R-2313T	Amber	Neon	125	1/3W	25,000
35R-2313	35R-2313T	Amber	Neon	250	1/3W	25,000
32RG1-2313	32RG1-2313T	Amber	Incandescent	6	.20A	5,000
32RG3-2313	32RG3-2313T	Amber	Incandescent	14	.10A	10,000
32RG18-2313	32RG18-2313T	Amber	Incandescent	28	.04A	7,000
32R-2314	32R-2314T	Blue	Neon	125	1/3W	25,000
35R-2314	35R-2314T	Blue	Neon	250	1/3W	25,000
32RG1-2314	32RG1-2314T	Blue	Incandescent	6	.20A	5,000
32RG3-2314	32RG3-2314T	Blue	Incandescent	14	.10A	10,000
32RG18-2314	32RG18-2314T	Blue	Incandescent	28	.04A	7,000
32R-2315	32R-2315T	White	Neon	125	1/3W	25,000
35R-2315	35R-2315T	White	Neon	250	1/3W	25,000
32RG1-2315	32RG1-2315T	White	Incandescent	6	.20A	5,000
32RG3-2315	32RG3-2315T	White	Incandescent	14	.10A	10,000
32RG18-2315	32RG18-2315T	White	Incandescent	28	.04A	7,000
32R-2317	32R-2317T	Clear	Neon	125	1/3W	25,000
32R-2317	32R-2317T	Clear	Neon	250	1/3W	25,000
32RG1-2317	32RG1-2317T	Clear	Incandescent	6	.20A	5,000
32RG3-2317	32RG3-2317T	Clear	Incandescent	14	.10A	10,000
32RG18-2317	32RG18-2317T	Clear	Incandescent	28	.04A	7,000

Hi-Hat Lens without Bezel - Neon or Incandescent

Hi-Hat Lens Style
Without bezel.

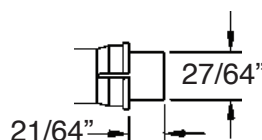

Part Number 6" Wire Leads	Part Number 3/16" Tab Terminals	Lens Color	Lamp Type	Design Volts	Design Watts or Amps	Life (hrs)
32-2511	32-2511T	Red	Neon	125	1/3W	25,000
35-2511	35-2511T	Red	Neon	250	1/3W	25,000
32G1-2511	32G1-2511T	Red	Incandescent	6	.20A	5,000
32G3-2511	32G3-2511T	Red	Incandescent	14	.10A	10,000
32G18-2511	32G18-2511T	Red	Incandescent	28	.04A	7,000
32-2512	32-2512T	Green	Neon	125	1/3W	25,000
35-2512	35-2512T	Green	Neon	250	1/3W	25,000
32G1-2512	32G1-2512T	Green	Incandescent	6	.20A	5,000
32G3-2512	32G3-2512T	Green	Incandescent	14	.10A	10,000
32G18-2512	32G18-2512T	Green	Incandescent	28	.04A	7,000
32-2513	32-2513T	Amber	Neon	125	1/3W	25,000
35-2513	35-2513T	Amber	Neon	250	1/3W	25,000
32G1-2513	32G1-2513T	Amber	Incandescent	6	.20A	5,000
32G3-2513	32G3-2513T	Amber	Incandescent	14	.10A	10,000
32G18-2513	32G18-2513T	Amber	Incandescent	28	.04A	7,000
32-2514	32-2514T	Blue	Neon	125	1/3W	25,000
35-2514	35-2514T	Blue	Neon	250	1/3W	25,000
32G1-2514	32G1-2514T	Blue	Incandescent	6	.20A	5,000
32G3-2514	32G3-2514T	Blue	Incandescent	14	.10A	10,000
32G18-2514	32G18-2514T	Blue	Incandescent	28	.04A	7,000
32-2515	32-2515T	White	Neon	125	1/3W	25,000
35-2515	35-2515T	White	Neon	250	1/3W	25,000
32G1-2515	32G1-2515T	White	Incandescent	6	.20A	5,000
32G3-2515	32G3-2515T	White	Incandescent	14	.10A	10,000
32G18-2515	32G18-2515T	White	Incandescent	28	.04A	7,000
32-2517	32-2517T	Clear	Neon	125	1/3W	25,000
32-2517	32-2517T	Clear	Neon	250	1/3W	25,000
32G1-2517	32G1-2517T	Clear	Incandescent	6	.20A	5,000
32G3-2517	32G3-2517T	Clear	Incandescent	14	.10A	10,000
32G18-2517	32G18-2517T	Clear	Incandescent	28	.04A	7,000

Hi-Hat Lens Nickel Plated Bezel - Neon or Incandescent

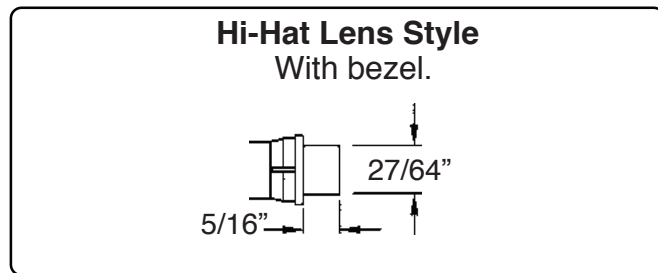

Part Number 6" Wire Leads	Part Number 3/16" Tab Terminals	Lens Color	Lamp Type	Design Volts	Design Watts or Amps	Life (hrs)
32R-2511	32R-2511T	Red	Neon	125	1/3W	25,000
35R-2511	35R-2511T	Red	Neon	250	1/3W	25,000
32RG1-2511	32RG1-2511T	Red	Incandescent	6	.20A	5,000
32RG3-2511	32RG3-2511T	Red	Incandescent	14	.10A	10,000
32RG18-2511	32RG18-2511T	Red	Incandescent	28	.04A	7,000
32R-2512	32R-2512T	Green	Neon	125	1/3W	25,000
35R-2512	35R-2512T	Green	Neon	250	1/3W	25,000
32RG1-2512	32RG1-2512T	Green	Incandescent	6	.20A	5,000
32RG3-2512	32RG3-2512T	Green	Incandescent	14	.10A	10,000
32RG18-2512	32RG18-2512T	Green	Incandescent	28	.04A	7,000
32R-2513	32R-2513T	Amber	Neon	125	1/3W	25,000
35R-2513	35R-2513T	Amber	Neon	250	1/3W	25,000
32RG1-2513	32RG1-2513T	Amber	Incandescent	6	.20A	5,000
32RG3-2513	32RG3-2513T	Amber	Incandescent	14	.10A	10,000
32RG18-2513	32RG18-2513T	Amber	Incandescent	28	.04A	7,000
32R-2514	32R-2514T	Blue	Neon	125	1/3W	25,000
35R-2514	35R-2514T	Blue	Neon	250	1/3W	25,000
32RG1-2514	32RG1-2514T	Blue	Incandescent	6	.20A	5,000
32RG3-2514	32RG3-2514T	Blue	Incandescent	14	.10A	10,000
32RG18-2514	32RG18-2514T	Blue	Incandescent	28	.04A	7,000
32R-2515	32R-2515T	White	Neon	125	1/3W	25,000
35R-2515	35R-2515T	White	Neon	250	1/3W	25,000
32RG1-2515	32RG1-2515T	White	Incandescent	6	.20A	5,000
32RG3-2515	32RG3-2515T	White	Incandescent	14	.10A	10,000
32RG18-2515	32RG18-2515T	White	Incandescent	28	.04A	7,000
32R-2517	32R-2517T	Clear	Neon	125	1/3W	25,000
32R-2517	32R-2517T	Clear	Neon	250	1/3W	25,000
32RG1-2517	32RG1-2517T	Clear	Incandescent	6	.20A	5,000
32RG3-2517	32RG3-2517T	Clear	Incandescent	14	.10A	10,000
32RG18-2517	32RG18-2517T	Clear	Incandescent	28	.04A	7,000

Square Lens Nickel Plated Bezel - Neon or Incandescent

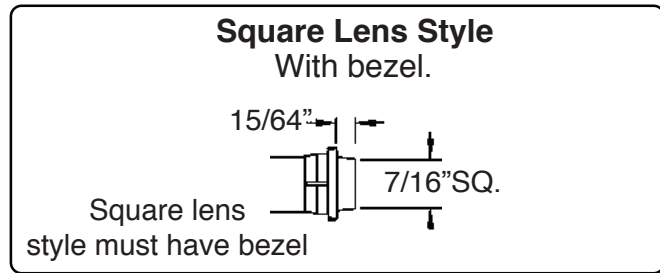
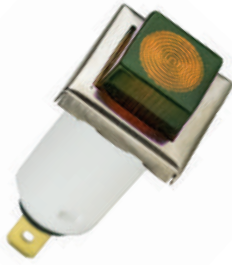

Part Number 6" Wire Leads	Part Number 3/16" Tab Terminals	Lens Color	Lamp Type	Design Volts	Design Watts or Amps	Life (hrs)
32R-2911	32R-2911T	Red	Neon	125	1/3W	25,000
35R-2911	35R-2911T	Red	Neon	250	1/3W	25,000
32RG1-2911	32RG1-2911T	Red	Incandescent	6	.20A	5,000
32RG3-2911	32RG3-2911T	Red	Incandescent	14	.10A	10,000
32RG18-2911	32RG18-2911T	Red	Incandescent	28	.04A	7,000
32R-2912	32R-2912T	Green	Neon	125	1/3W	25,000
35R-2912	35R-2912T	Green	Neon	250	1/3W	25,000
32RG1-2912	32RG1-2912T	Green	Incandescent	6	.20A	5,000
32RG3-2912	32RG3-2912T	Green	Incandescent	14	.10A	10,000
32RG18-2912	32RG18-2912T	Green	Incandescent	28	.04A	7,000
32R-2913	32R-2913T	Amber	Neon	125	1/3W	25,000
35R-2913	35R-2913T	Amber	Neon	250	1/3W	25,000
32RG1-2913	32RG1-2913T	Amber	Incandescent	6	.20A	5,000
32RG3-2913	32RG3-2913T	Amber	Incandescent	14	.10A	10,000
32RG18-2913	32RG18-2913T	Amber	Incandescent	28	.04A	7,000
32R-2914	32R-2914T	Blue	Neon	125	1/3W	25,000
35R-2914	35R-2914T	Blue	Neon	250	1/3W	25,000
32RG1-2914	32RG1-2914T	Blue	Incandescent	6	.20A	5,000
32RG3-2914	32RG3-2914T	Blue	Incandescent	14	.10A	10,000
32RG18-2914	32RG18-2914T	Blue	Incandescent	28	.04A	7,000
32R-2915	32R-2915T	White	Neon	125	1/3W	25,000
35R-2915	35R-2915T	White	Neon	250	1/3W	25,000
32RG1-2915	32RG1-2915T	White	Incandescent	6	.20A	5,000
32RG3-2915	32RG3-2915T	White	Incandescent	14	.10A	10,000
32RG18-2915	32RG18-2915T	White	Incandescent	28	.04A	7,000
32R-2917	32R-2917T	Clear	Neon	125	1/3W	25,000
32R-2917	32R-2917T	Clear	Neon	250	1/3W	25,000
32RG1-2917	32RG1-2917T	Clear	Incandescent	6	.20A	5,000
32RG3-2917	32RG3-2917T	Clear	Incandescent	14	.10A	10,000
32RG18-2917	32RG18-2917T	Clear	Incandescent	28	.04A	7,000

Flashing Indicators Optional Nickel Plated Bezel

Neon lights are designed with outboard circuitry to provide a flashing action of about 100 times per minute. Flashers are ideal for applications where a warning indicator is desirable. 125 Volt Operation.

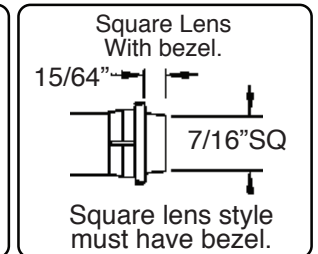
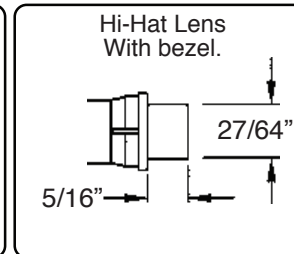
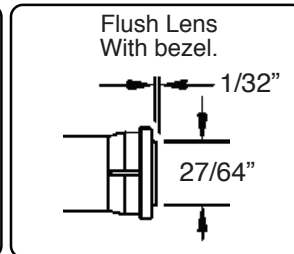
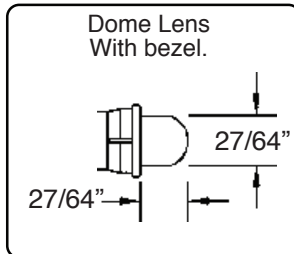
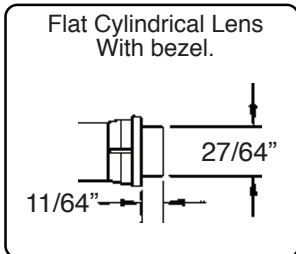

Part Number Without Bezel	Part Number with Nickel Plated Bezel	Lens Color	Lamp Style	Design Volts	Design Watts or Amps	Life (hrs)
32FL-2111	32FLR-2111	Red	Flat Cylindrical	125	1/3W	25,000
32FL-2112	32FLR-2112	Green	Flat Cylindrical	125	1/3W	25,000
32FL-2113	32FLR-2113	Amber	Flat Cylindrical	125	1/3W	25,000
32FL-2114	32FLR-2114	Blue	Flat Cylindrical	125	1/3W	25,000
32FL-2115	32FLR-2115	White	Flat Cylindrical	125	1/3W	25,000
32FL-2117	32FLR-2117	Clear	Flat Cylindrical	125	1/3W	25,000
32FL-2211	32FLR-2211	Red	Dome	125	1/3W	25,000
32FL-2212	32FLR-2212	Green	Dome	125	1/3W	25,000
32FL-2213	32FLR-2213	Amber	Dome	125	1/3W	25,000
32FL-2214	32FLR-2214	Blue	Dome	125	1/3W	25,000
32FL-2215	32FLR-2215	White	Dome	125	1/3W	25,000
32FL-2217	32FLR-2217	Clear	Dome	125	1/3W	25,000
32FL-2311	32FLR-2311	Red	Flush	125	1/3W	25,000
32FL-2312	32FLR-2312	Green	Flush	125	1/3W	25,000
32FL-2313	32FLR-2313	Amber	Flush	125	1/3W	25,000
32FL-2314	32FLR-2314	Blue	Flush	125	1/3W	25,000
32FL-2315	32FLR-2315	White	Flush	125	1/3W	25,000
32FL-2317	32FLR-2317	Clear	Flush	125	1/3W	25,000
32FL-2511	32FLR-2511	Red	Hi-Hat	125	1/3W	25,000
32FL-2512	32FLR-2512	Green	Hi-Hat	125	1/3W	25,000
32FL-2513	32FLR-2513	Amber	Hi-Hat	125	1/3W	25,000
32FL-2514	32FLR-2514	Blue	Hi-Hat	125	1/3W	25,000
32FL-2515	32FLR-2515	White	Hi-Hat	125	1/3W	25,000
32FL-2517	32FLR-2517	Clear	Hi-Hat	125	1/3W	25,000
N/A	32FLR-2911	Red	Square	125	1/3W	25,000
N/A	32FLR-2912	Green	Square	125	1/3W	25,000
N/A	32FLR-2913	Amber	Square	125	1/3W	25,000
N/A	32FLR-2914	Blue	Square	125	1/3W	25,000
N/A	32FLR-2915	White	Square	125	1/3W	25,000
N/A	32FLR-2917	Clear	Square	125	1/3W	25,000

35XK Series - 600 Design Volts Neon Indicators - White Housing



Square lens style must have bezel.

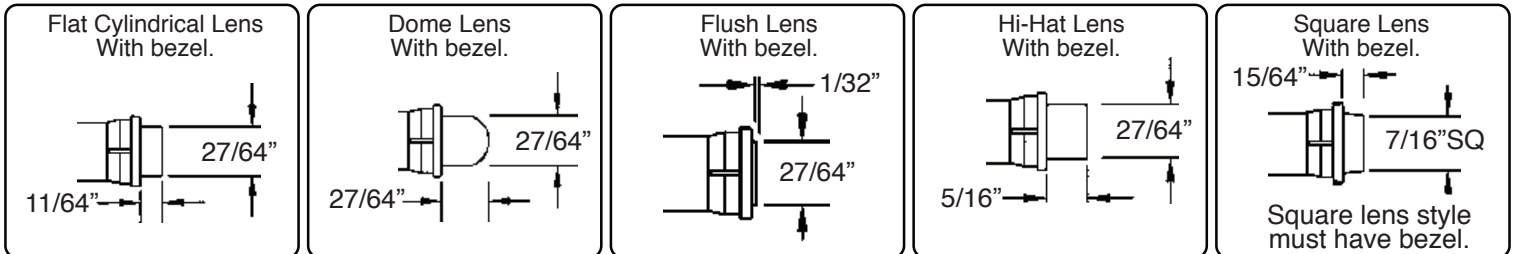

Part Number Without Bezel	Part Number with Nickel Plated Bezel	Lens Color	Lamp Style	Design Volts	Design Watts	Life (hrs)
35XK-2111	35RXK-2111	Red	Flat Cylindrical	600	1/3W	25,000
35XK-2112	35RXK-2112	Green	Flat Cylindrical	600	1/3W	25,000
35XK-2113	35RXK-2113	Amber	Flat Cylindrical	600	1/3W	25,000
35XK-2114	35RXK-2114	Blue	Flat Cylindrical	600	1/3W	25,000
35XK-2115	35RXK-2115	White	Flat Cylindrical	600	1/3W	25,000
35XK-2117	35RXK-2117	Clear	Flat Cylindrical	600	1/3W	25,000
35XK-2211	35RXK-2211	Red	Dome	600	1/3W	25,000
35XK-2212	35RXK-2212	Green	Dome	600	1/3W	25,000
35XK-2213	35RXK-2213	Amber	Dome	600	1/3W	25,000
35XK-2214	35RXK-2214	Blue	Dome	600	1/3W	25,000
35XK-2215	35RXK-2215	White	Dome	600	1/3W	25,000
35XK-2217	35RXK-2217	Clear	Dome	600	1/3W	25,000
35XK-2311	35RXK-2311	Red	Flush	600	1/3W	25,000
35XK-2312	35RXK-2312	Green	Flush	600	1/3W	25,000
35XK-2313	35RXK-2313	Amber	Flush	600	1/3W	25,000
35XK-2314	35RXK-2314	Blue	Flush	600	1/3W	25,000
35XK-2315	35RXK-2315	White	Flush	600	1/3W	25,000
35XK-2317	35RXK-2317	Clear	Flush	600	1/3W	25,000
35XK-2511	35RXK-2511	Red	Hi-Hat	600	1/3W	25,000
35XK-2512	35RXK-2512	Green	Hi-Hat	600	1/3W	25,000
35XK-2513	35RXK-2513	Amber	Hi-Hat	600	1/3W	25,000
35XK-2514	35RXK-2514	Blue	Hi-Hat	600	1/3W	25,000
35XK-2515	35RXK-2515	White	Hi-Hat	600	1/3W	25,000
35XK-2517	35RXK-2517	Clear	Hi-Hat	600	1/3W	25,000
N/A	35RXK-2911	Red	Square	600	1/3W	25,000
N/A	35RXK-2912	Green	Square	600	1/3W	25,000
N/A	35RXK-2913	Amber	Square	600	1/3W	25,000
N/A	35RXK-2914	Blue	Square	600	1/3W	25,000
N/A	35RXK-2915	White	Square	600	1/3W	25,000
N/A	35RXK-2917	Clear	Square	600	1/3W	25,000

L32/35 Series - LED Indicator Light White Housing 2 to 125 Design Volts



Part Number With Flat Cylindrical Lens	Part Number With Dome Lens	Part Number With Flush Lens	Part Number With Hi-Hat Lens	Part Number With Square Lens	Lens Color	DC Design Volts *AC Design Volts
L32R-A2-2113	L32R-A2-2213	L32R-A2-2313	L32R-A2-2513	L32R-A2-2913	Amber	2
L32R-A6-2113	L32R-A6-2213	L32R-A6-2313	L32R-A6-2513	L32R-A6-2913	Amber	6
L32R-A12-2113	L32R-A12-2213	L32R-A12-2313	L32R-A12-2513	L32R-A12-2913	Amber	12
L32R-A24-2113	L32R-A24-2213	L32R-A24-2313	L32R-A24-2513	L32R-A24-2913	Amber	24
L32R-A125-2113	L32R-A125-2213	L32R-A125-2313	L32R-A125-2513	L32R-A125-2913	Amber	125*
L32R-G2-2112	L32R-G2-2212	L32R-G2-2312	L32R-G2-2512	L32R-G2-2912	Green	2
L32R-G6-2112	L32R-G6-2212	L32R-G6-2312	L32R-G6-2512	L32R-G6-2912	Green	6
L32R-G12-2112	L32R-G12-2212	L32R-G12-2312	L32R-G12-2512	L32R-G12-2912	Green	12
L32R-G24-2112	L32R-G24-2212	L32R-G24-2312	L32R-G24-2512	L32R-G24-2912	Green	24
L32R-G125-2112	L32R-G125-2212	L32R-G125-2312	L32R-G125-2512	L32R-G125-2912	Green	125*
L32R-R2-2111	L32R-R2-2211	L32R-R2-2311	L32R-R2-2511	L32R-R2-2911	Red	2
L32R-R6-2111	L32R-R6-2211	L32R-R6-2311	L32R-R6-2511	L32R-R6-2911	Red	6
L32R-R12-2111	L32R-R12-2211	L32R-R12-2311	L32R-R12-2511	L32R-R12-2911	Red	12
L32R-R24-2111	L32R-R24-2211	L32R-R24-2311	L32R-R24-2511	L32R-R24-2911	Red	24
L32R-R125-2111	L32R-R125-2211	L32R-R125-2311	L32R-R125-2511	L32R-R125-2911	Red	125*
L32R-Y2-2116	L32R-Y2-2216	L32R-Y2-2316	L32R-Y2-2516	L32R-Y2-2916	Yellow	2
L32R-Y6-2116	L32R-Y6-2216	L32R-Y6-2316	L32R-Y6-2516	L32R-Y6-2916	Yellow	6
L32R-Y12-2116	L32R-Y12-2216	L32R-Y12-2316	L32R-Y12-2516	L32R-Y12-2916	Yellow	12
L32R-Y24-2116	L32R-Y24-2216	L32R-Y24-2316	L32R-Y24-2516	L32R-Y24-2916	Yellow	24
L32R-Y125-2116	L32R-Y125-2216	L32R-Y125-2316	L32R-Y125-2516	L32R-Y125-2916	Yellow	125*

Polarity Determination - Wire Leads: Red wire lead denotes anode(+); black wire lead denote cathode (-).

Terminals: One terminal is tin-plated to denote anode(+); unplated terminal refer to cathode(-)

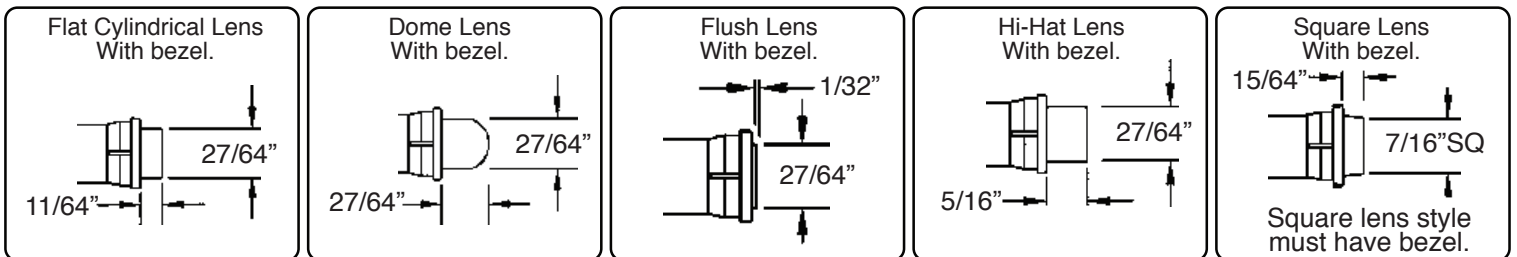

L32 Series - LED Indicator Light White Housing 2 to 24 Design Volts

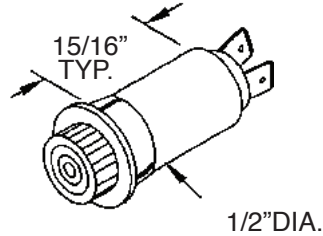

Part Number With Flat Cylindrical Lens	Part Number With Dome Lens	Part Number With Flush Lens	Part Number With Hi-Hat Lens	Part Number With Square Lens	Lens Color	DC Design Volts
L32R-A2-2113T	L32R-A2-2213T	L32R-A2-2313T	L32R-A2-2513T	L32R-A2-2913T	Amber	2
L32R-A6-2113T	L32R-A6-2213T	L32R-A6-2313T	L32R-A6-2513T	L32R-A6-2913T	Amber	6
L32R-A12-2113T	L32R-A12-2213T	L32R-A12-2313T	L32R-A12-2513T	L32R-A12-2913T	Amber	12
L32R-A24-2113T	L32R-A24-2213T	L32R-A24-2313T	L32R-A24-2513T	L32R-A24-2913T	Amber	24
L32R-A125-2112T	L32R-A125-2212T	L32R-A125-2312T	L32R-A125-2512T	L32R-A125-2912T	Green	2
L32R-G2-2112T	L32R-G2-2212T	L32R-G2-2312T	L32R-G2-2512T	L32R-G2-2912T	Green	6
L32R-G6-2112T	L32R-G6-2212T	L32R-G6-2312T	L32R-G6-2512T	L32R-G6-2912T	Green	12
L32R-G12-2112T	L32R-G12-2212T	L32R-G12-2312T	L32R-G12-2512T	L32R-G12-2912T	Green	24
L32R-G24-2111T	L32R-G24-2211T	L32R-G24-2311T	L32R-G24-2511T	L32R-G24-2911T	Red	2
L32R-G125-2111T	L32R-G125-2211T	L32R-G125-2311T	L32R-G125-2511T	L32R-G125-2911T	Red	6
L32R-R2-2111T	L32R-R2-2211T	L32R-R2-2311T	L32R-R2-2511T	L32R-R2-2911T	Red	12
L32R-R6-2111T	L32R-R6-2211T	L32R-R6-2311T	L32R-R6-2511T	L32R-R6-2911T	Red	24
L32R-R12-2116T	L32R-R12-2216T	L32R-R12-2316T	L32R-R12-2516T	L32R-R12-2916T	Yellow	2
L32R-R24-2116T	L32R-R24-2216T	L32R-R24-2316T	L32R-R24-2516T	L32R-R24-2916T	Yellow	6
L32R-R125-2116T	L32R-R125-2216T	L32R-R125-2316T	L32R-R125-2516T	L32R-R125-2916T	Yellow	12
L32R-Y2-2116T	L32R-Y2-2216T	L32R-Y2-2316T	L32R-Y2-2516T	L32R-Y2-2916T	Yellow	24

Polarity Determination - Wire Leads: Red wire lead denotes anode(+); black wire lead denote cathode (-).
Terminals: One terminal is tin-plated to denote anode(+); unplated terminal refer to cathode(-)

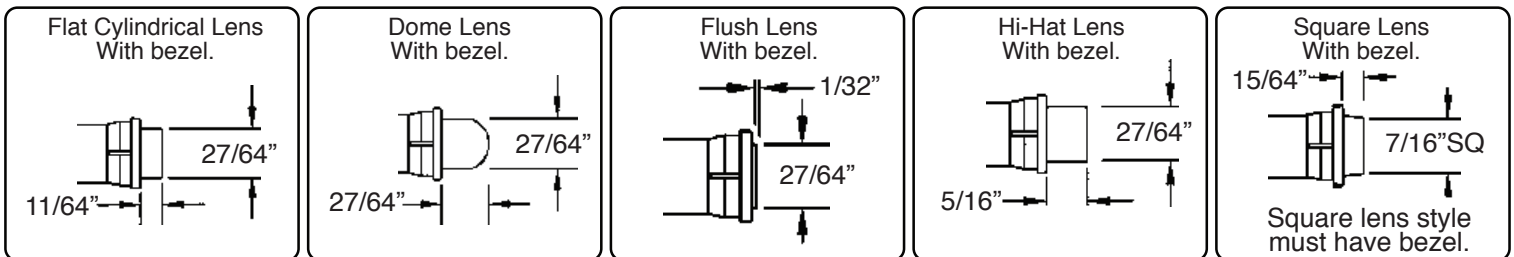



Компания «ЭлектроПласт» предлагает заключение долгосрочных отношений при поставках импортных электронных компонентов на взаимовыгодных условиях!

Наши преимущества:

- Оперативные поставки широкого спектра электронных компонентов отечественного и импортного производства напрямую от производителей и с крупнейших мировых складов;
- Поставка более 17-ти миллионов наименований электронных компонентов;
- Поставка сложных, дефицитных, либо снятых с производства позиций;
- Оперативные сроки поставки под заказ (от 5 рабочих дней);
- Экспресс доставка в любую точку России;
- Техническая поддержка проекта, помощь в подборе аналогов, поставка прототипов;
- Система менеджмента качества сертифицирована по Международному стандарту ISO 9001;
- Лицензия ФСБ на осуществление работ с использованием сведений, составляющих государственную тайну;
- Поставка специализированных компонентов (Xilinx, Altera, Analog Devices, Intersil, Interpoint, Microsemi, Aeroflex, Peregrine, Syfer, Eurofarad, Texas Instrument, Miteq, Cobham, E2V, MA-COM, Hittite, Mini-Circuits, General Dynamics и др.);

Помимо этого, одним из направлений компании «ЭлектроПласт» является направление «Источники питания». Мы предлагаем Вам помощь Конструкторского отдела:

- Подбор оптимального решения, техническое обоснование при выборе компонента;
- Подбор аналогов;
- Консультации по применению компонента;
- Поставка образцов и прототипов;
- Техническая поддержка проекта;
- Защита от снятия компонента с производства.



Как с нами связаться

Телефон: 8 (812) 309 58 32 (многоканальный)

Факс: 8 (812) 320-02-42

Электронная почта: org@eplast1.ru

Адрес: 198099, г. Санкт-Петербург, ул. Калинина, дом 2, корпус 4, литера А.