



32, 35, L32 Series Pressfit Indicator Light for 1/2" Diameter Mounting Hole



- NEON, LED & INCANDESCENT
- 2 TO 600 DESIGN VOLTS
- 6" WIRE LEADS & 3/16" TAB TERMINALS
- VARIETY OF LENS COLORS
- cULus CERTIFIED (UL FILE E20356)
- QUICK DISCONNECT TERMINAL CE CERTIFIED

Overview

The 32/35 Series Indicators feature a wide variety of lenses, colors, voltage & bezel variations. Indicators quickly pressfit into a 0.500" to 0.510" mounting hole with recommended panel thickness range of 0.020" min. to 0.090" max.

Specifications

Housing: White nylon. A black housing is available.

Bezel: Nickel plated brass. A black anodized bezel is available.

Lens: polycarbonate.

Incandescent AC or DC voltage options: 6, 14 and 28 volts.

Neon AC or DC voltage options: 125 and 250 and 600 volts.

Note: high brightness green and blue neon lamps supplied in green and blue neon applications.

Led DC voltage options: 2, 6, 12, 24 volts.

Led AC voltage options: 125 volts.

Note: 125 volts AC units contain a bi-polar LED.
LED versions are not CE Certified.

Two 6" wire leads: #20 AWG, black, bare copper, PVC insulated, UL/CSA rated 105 °C, 600 V, UL style 1015, stripped 1/2". For DC LED units, wire leads are color-coded red and black; the red wire lead denotes the anode (+) while a black wire lead identifies the cathode (-). For AC LED units, wire leads are white. Custom wire lengths, stripping, termination and wire type are available.

Terminals:

3/16 tabs: Brass, (0.187" length x 0.020" thick). For LED units, a tin plated terminal denotes the anode (+). 1/4" or 1/8" brass tab terminals are available.

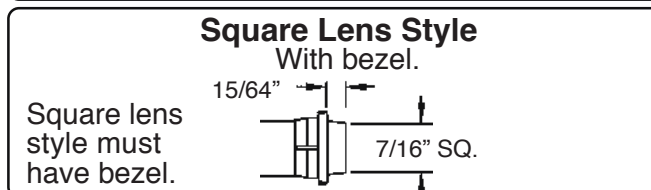
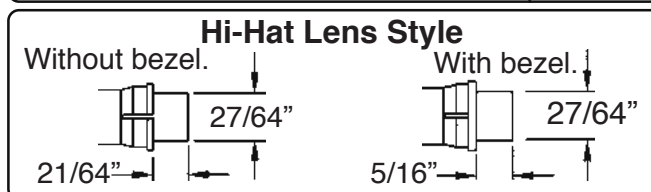
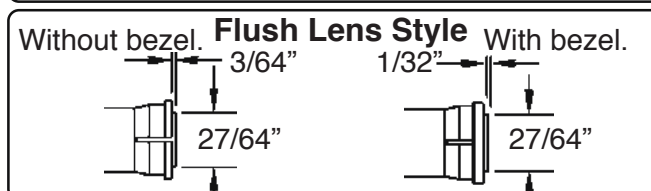
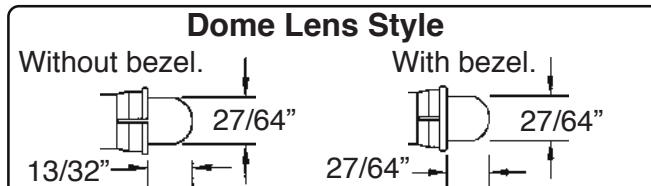
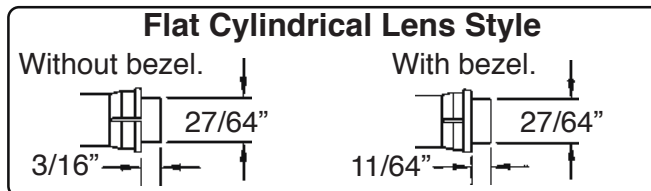
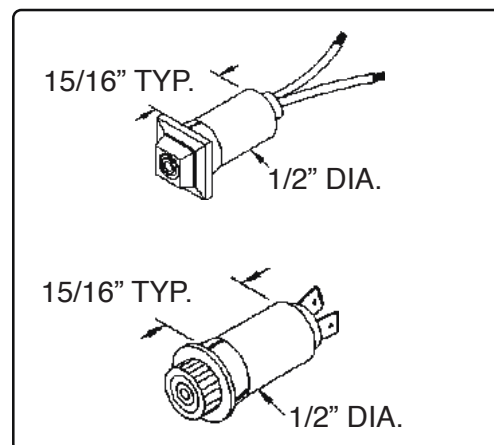

Flat Cylindrical Lens without Bezel - Neon or Incandescent



Flat Cylindrical Style
Without bezel.

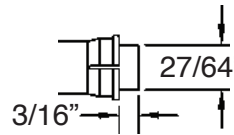

| Part Number 6" Wire Leads | Part Number 3/16" Tab Terminals | Lens Color | Lamp Type | Design Volts | Design Watts or Amps | Life (hrs) |
|------------------------------|------------------------------------|------------|--------------|--------------|-------------------------|------------|
| 32-2111 | 32-2111T | Red | Neon | 125 | 1/3W | 25,000 |
| 35-2111 | 35-2111T | Red | Neon | 250 | 1/3W | 25,000 |
| 32G1-2111 | 32G1-2111T | Red | Incandescent | 6 | .20A | 5,000 |
| 32G3-2111 | 32G3-2111T | Red | Incandescent | 14 | .10A | 10,000 |
| 32G18-2111 | 32G18-2111T | Red | Incandescent | 28 | .04A | 7,000 |
| 32-2112 | 32-2112T | Green | Neon | 125 | 1/3W | 25,000 |
| 35-2112 | 35-2112T | Green | Neon | 250 | 1/3W | 25,000 |
| 32G1-2112 | 32G1-2112T | Green | Incandescent | 6 | .20A | 5,000 |
| 32G3-2112 | 32G3-2112T | Green | Incandescent | 14 | .10A | 10,000 |
| 32G18-2112 | 32G18-2112T | Green | Incandescent | 28 | .04A | 7,000 |
| 32-2113 | 32-2113T | Amber | Neon | 125 | 1/3W | 25,000 |
| 35-2113 | 35-2113T | Amber | Neon | 250 | 1/3W | 25,000 |
| 32G1-2113 | 32G1-2113T | Amber | Incandescent | 6 | .20A | 5,000 |
| 32G3-2113 | 32G3-2113T | Amber | Incandescent | 14 | .10A | 10,000 |
| 32G18-2113 | 32G18-2113T | Amber | Incandescent | 28 | .04A | 7,000 |
| 32-2114 | 32-2114T | Blue | Neon | 125 | 1/3W | 25,000 |
| 35-2114 | 35-2114T | Blue | Neon | 250 | 1/3W | 25,000 |
| 32G1-2114 | 32G1-2114T | Blue | Incandescent | 6 | .20A | 5,000 |
| 32G3-2114 | 32G3-2114T | Blue | Incandescent | 14 | .10A | 10,000 |
| 32G18-2114 | 32G18-2114T | Blue | Incandescent | 28 | .04A | 7,000 |
| 32-2115 | 32-2115T | White | Neon | 125 | 1/3W | 25,000 |
| 35-2115 | 35-2115T | White | Neon | 250 | 1/3W | 25,000 |
| 32G1-2115 | 32G1-2115T | White | Incandescent | 6 | .20A | 5,000 |
| 32G3-2115 | 32G3-2115T | White | Incandescent | 14 | .10A | 10,000 |
| 32G18-2115 | 32G18-2115T | White | Incandescent | 28 | .04A | 7,000 |
| 32-2117 | 32-2117T | Clear | Neon | 125 | 1/3W | 25,000 |
| 32-2117 | 32-2117T | Clear | Neon | 250 | 1/3W | 25,000 |
| 32G1-2117 | 32G1-2117T | Clear | Incandescent | 6 | .20A | 5,000 |
| 32G3-2117 | 32G3-2117T | Clear | Incandescent | 14 | .10A | 10,000 |
| 32G18-2117 | 32G18-2117T | Clear | Incandescent | 28 | .04A | 7,000 |

Flat Cylindrical Lens Nickel Plated Bezel - Neon or Incandescent



Flat Cylindrical Lens Style
With bezel.

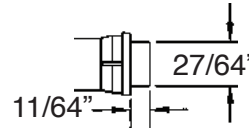

| Part Number 6" Wire Leads | Part Number 3/16" Tab Terminals | Lens Color | Lamp Type | Design Volts | Design Watts or Amps | Life (hrs) |
|------------------------------|------------------------------------|------------|--------------|--------------|-------------------------|------------|
| 32R-2111 | 32R-2111T | Red | Neon | 125 | 1/3W | 25,000 |
| 35R-2111 | 35R-2111T | Red | Neon | 250 | 1/3W | 25,000 |
| 32RG1-2111 | 32RG1-2111T | Red | Incandescent | 6 | .20A | 5,000 |
| 32RG3-2111 | 32RG3-2111T | Red | Incandescent | 14 | .10A | 10,000 |
| 32RG18-2111 | 32RG18-2111T | Red | Incandescent | 28 | .04A | 7,000 |
| 32R-2112 | 32R-2112T | Green | Neon | 125 | 1/3W | 25,000 |
| 35R-2112 | 35R-2112T | Green | Neon | 250 | 1/3W | 25,000 |
| 32RG1-2112 | 32RG1-2112T | Green | Incandescent | 6 | .20A | 5,000 |
| 32RG3-2112 | 32RG3-2112T | Green | Incandescent | 14 | .10A | 10,000 |
| 32RG18-2112 | 32RG18-2112T | Green | Incandescent | 28 | .04A | 7,000 |
| 32R-2113 | 32R-2113T | Amber | Neon | 125 | 1/3W | 25,000 |
| 35R-2113 | 35R-2113T | Amber | Neon | 250 | 1/3W | 25,000 |
| 32RG1-2113 | 32RG1-2113T | Amber | Incandescent | 6 | .20A | 5,000 |
| 32RG3-2113 | 32RG3-2113T | Amber | Incandescent | 14 | .10A | 10,000 |
| 32RG18-2113 | 32RG18-2113T | Amber | Incandescent | 28 | .04A | 7,000 |
| 32R-2114 | 32R-2114T | Blue | Neon | 125 | 1/3W | 25,000 |
| 35R-2114 | 35R-2114T | Blue | Neon | 250 | 1/3W | 25,000 |
| 32RG1-2114 | 32RG1-2114T | Blue | Incandescent | 6 | .20A | 5,000 |
| 32RG3-2114 | 32RG3-2114T | Blue | Incandescent | 14 | .10A | 10,000 |
| 32RG18-2114 | 32RG18-2114T | Blue | Incandescent | 28 | .04A | 7,000 |
| 32R-2115 | 32R-2115T | White | Neon | 125 | 1/3W | 25,000 |
| 35R-2115 | 35R-2115T | White | Neon | 250 | 1/3W | 25,000 |
| 32RG1-2115 | 32RG1-2115T | White | Incandescent | 6 | .20A | 5,000 |
| 32RG3-2115 | 32RG3-2115T | White | Incandescent | 14 | .10A | 10,000 |
| 32RG18-2115 | 32RG18-2115T | White | Incandescent | 28 | .04A | 7,000 |
| 32R-2117 | 32R-2117T | Clear | Neon | 125 | 1/3W | 25,000 |
| 32R-2117 | 32R-2117T | Clear | Neon | 250 | 1/3W | 25,000 |
| 32RG1-2117 | 32RG1-2117T | Clear | Incandescent | 6 | .20A | 5,000 |
| 32RG3-2117 | 32RG3-2117T | Clear | Incandescent | 14 | .10A | 10,000 |
| 32RG18-2117 | 32RG18-2117T | Clear | Incandescent | 28 | .04A | 7,000 |

Dome Lens without Bezel - Neon or Incandescent



Dome Lens Style
Without bezel.

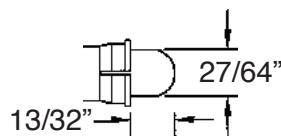

| Part Number 6" Wire Leads | Part Number 3/16" Tab Terminals | Lens Color | Lamp Type | Design Volts | Design Watts or Amps | Life (hrs) |
|------------------------------|------------------------------------|------------|--------------|--------------|-------------------------|------------|
| 32-2211 | 32-2211T | Red | Neon | 125 | 1/3W | 25,000 |
| 35-2211 | 35-2211T | Red | Neon | 250 | 1/3W | 25,000 |
| 32G1-2211 | 32G1-2211T | Red | Incandescent | 6 | .20A | 5,000 |
| 32G3-2211 | 32G3-2211T | Red | Incandescent | 14 | .10A | 10,000 |
| 32G18-2211 | 32G18-2211T | Red | Incandescent | 28 | .04A | 7,000 |
| 32-2212 | 32-2212T | Green | Neon | 125 | 1/3W | 25,000 |
| 35-2212 | 35-2212T | Green | Neon | 250 | 1/3W | 25,000 |
| 32G1-2212 | 32G1-2212T | Green | Incandescent | 6 | .20A | 5,000 |
| 32G3-2212 | 32G3-2212T | Green | Incandescent | 14 | .10A | 10,000 |
| 32G18-2212 | 32G18-2212T | Green | Incandescent | 28 | .04A | 7,000 |
| 32-2213 | 32-2213T | Amber | Neon | 125 | 1/3W | 25,000 |
| 35-2213 | 35-2213T | Amber | Neon | 250 | 1/3W | 25,000 |
| 32G1-2213 | 32G1-2213T | Amber | Incandescent | 6 | .20A | 5,000 |
| 32G3-2213 | 32G3-2213T | Amber | Incandescent | 14 | .10A | 10,000 |
| 32G18-2213 | 32G18-2213T | Amber | Incandescent | 28 | .04A | 7,000 |
| 32-2214 | 32-2214T | Blue | Neon | 125 | 1/3W | 25,000 |
| 35-2214 | 35-2214T | Blue | Neon | 250 | 1/3W | 25,000 |
| 32G1-2214 | 32G1-2214T | Blue | Incandescent | 6 | .20A | 5,000 |
| 32G3-2214 | 32G3-2214T | Blue | Incandescent | 14 | .10A | 10,000 |
| 32G18-2214 | 32G18-2214T | Blue | Incandescent | 28 | .04A | 7,000 |
| 32-2215 | 32-2215T | White | Neon | 125 | 1/3W | 25,000 |
| 35-2215 | 35-2215T | White | Neon | 250 | 1/3W | 25,000 |
| 32G1-2215 | 32G1-2215T | White | Incandescent | 6 | .20A | 5,000 |
| 32G3-2215 | 32G3-2215T | White | Incandescent | 14 | .10A | 10,000 |
| 32G18-2215 | 32G18-2215T | White | Incandescent | 28 | .04A | 7,000 |
| 32-2217 | 32-2217T | Clear | Neon | 125 | 1/3W | 25,000 |
| 32-2217 | 32-2217T | Clear | Neon | 250 | 1/3W | 25,000 |
| 32G1-2217 | 32G1-2217T | Clear | Incandescent | 6 | .20A | 5,000 |
| 32G3-2217 | 32G3-2217T | Clear | Incandescent | 14 | .10A | 10,000 |
| 32G18-2217 | 32G18-2217T | Clear | Incandescent | 28 | .04A | 7,000 |

Dome Lens Nickel Plated Bezel - Neon or Incandescent

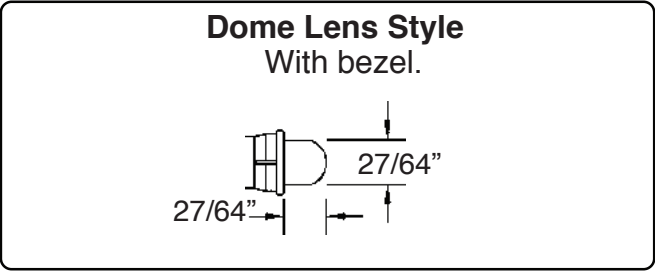

| Part Number 6" Wire Leads | Part Number 3/16" Tab Terminals | Lens Color | Lamp Type | Design Volts | Design Watts or Amps | Life (hrs) |
|------------------------------|------------------------------------|------------|--------------|--------------|-------------------------|------------|
| 32R-2211 | 32R-2211T | Red | Neon | 125 | 1/3W | 25,000 |
| 35R-2211 | 35R-2211T | Red | Neon | 250 | 1/3W | 25,000 |
| 32RG1-2211 | 32RG1-2211T | Red | Incandescent | 6 | .20A | 5,000 |
| 32RG3-2211 | 32RG3-2211T | Red | Incandescent | 14 | .10A | 10,000 |
| 32RG18-2211 | 32RG18-2211T | Red | Incandescent | 28 | .04A | 7,000 |
| 32R-2212 | 32R-2212T | Green | Neon | 125 | 1/3W | 25,000 |
| 35R-2212 | 35R-2212T | Green | Neon | 250 | 1/3W | 25,000 |
| 32RG1-2212 | 32RG1-2212T | Green | Incandescent | 6 | .20A | 5,000 |
| 32RG3-2212 | 32RG3-2212T | Green | Incandescent | 14 | .10A | 10,000 |
| 32RG18-2212 | 32RG18-2212T | Green | Incandescent | 28 | .04A | 7,000 |
| 32R-2213 | 32R-2213T | Amber | Neon | 125 | 1/3W | 25,000 |
| 35R-2213 | 35R-2213T | Amber | Neon | 250 | 1/3W | 25,000 |
| 32RG1-2213 | 32RG1-2213T | Amber | Incandescent | 6 | .20A | 5,000 |
| 32RG3-2213 | 32RG3-2213T | Amber | Incandescent | 14 | .10A | 10,000 |
| 32RG18-2213 | 32RG18-2213T | Amber | Incandescent | 28 | .04A | 7,000 |
| 32R-2214 | 32R-2214T | Blue | Neon | 125 | 1/3W | 25,000 |
| 35R-2214 | 35R-2214T | Blue | Neon | 250 | 1/3W | 25,000 |
| 32RG1-2214 | 32RG1-2214T | Blue | Incandescent | 6 | .20A | 5,000 |
| 32RG3-2214 | 32RG3-2214T | Blue | Incandescent | 14 | .10A | 10,000 |
| 32RG18-2214 | 32RG18-2214T | Blue | Incandescent | 28 | .04A | 7,000 |
| 32R-2215 | 32R-2215T | White | Neon | 125 | 1/3W | 25,000 |
| 35R-2215 | 35R-2215T | White | Neon | 250 | 1/3W | 25,000 |
| 32RG1-2215 | 32RG1-2215T | White | Incandescent | 6 | .20A | 5,000 |
| 32RG3-2215 | 32RG3-2215T | White | Incandescent | 14 | .10A | 10,000 |
| 32RG18-2215 | 32RG18-2215T | White | Incandescent | 28 | .04A | 7,000 |
| 32R-2217 | 32R-2217T | Clear | Neon | 125 | 1/3W | 25,000 |
| 32R-2217 | 32R-2217T | Clear | Neon | 250 | 1/3W | 25,000 |
| 32RG1-2217 | 32RG1-2217T | Clear | Incandescent | 6 | .20A | 5,000 |
| 32RG3-2217 | 32RG3-2217T | Clear | Incandescent | 14 | .10A | 10,000 |
| 32RG18-2217 | 32RG18-2217T | Clear | Incandescent | 28 | .04A | 7,000 |

Flush Lens without Bezel - Neon or Incandescent

Flush Lens Style Without bezel.



| Part Number 6" Wire Leads | Part Number 3/16" Tab Terminals | Lens Color | Lamp Type | Design Volts | Design Watts or Volts | Life (hrs) |
|------------------------------|------------------------------------|------------|--------------|--------------|--------------------------|------------|
| 32-2311 | 32-2311T | Red | Neon | 125 | 1/3W | 25,000 |
| 35-2311 | 35-2311T | Red | Neon | 250 | 1/3W | 25,000 |
| 32G1-2311 | 32G1-2311T | Red | Incandescent | 6 | .20A | 5,000 |
| 32G3-2311 | 32G3-2311T | Red | Incandescent | 14 | .10A | 10,000 |
| 32G18-2311 | 32G18-2311T | Red | Incandescent | 28 | .04A | 7,000 |
| 32-2312 | 32-2312T | Green | Neon | 125 | 1/3W | 25,000 |
| 35-2312 | 35-2312T | Green | Neon | 250 | 1/3W | 25,000 |
| 32G1-2312 | 32G1-2312T | Green | Incandescent | 6 | .20A | 5,000 |
| 32G3-2312 | 32G3-2312T | Green | Incandescent | 14 | .10A | 10,000 |
| 32G18-2312 | 32G18-2312T | Green | Incandescent | 28 | .04A | 7,000 |
| 32-2313 | 32-2313T | Amber | Neon | 125 | 1/3W | 25,000 |
| 35-2313 | 35-2313T | Amber | Neon | 250 | 1/3W | 25,000 |
| 32G1-2313 | 32G1-2313T | Amber | Incandescent | 6 | .20A | 5,000 |
| 32G3-2313 | 32G3-2313T | Amber | Incandescent | 14 | .10A | 10,000 |
| 32G18-2313 | 32G18-2313T | Amber | Incandescent | 28 | .04A | 7,000 |
| 32-2314 | 32-2314T | Blue | Neon | 125 | 1/3W | 25,000 |
| 35-2314 | 35-2314T | Blue | Neon | 250 | 1/3W | 25,000 |
| 32G1-2314 | 32G1-2314T | Blue | Incandescent | 6 | .20A | 5,000 |
| 32G3-2314 | 32G3-2314T | Blue | Incandescent | 14 | .10A | 10,000 |
| 32G18-2314 | 32G18-2314T | Blue | Incandescent | 28 | .04A | 7,000 |
| 32-2315 | 32-2315T | White | Neon | 125 | 1/3W | 25,000 |
| 35-2315 | 35-2315T | White | Neon | 250 | 1/3W | 25,000 |
| 32G1-2315 | 32G1-2315T | White | Incandescent | 6 | .20A | 5,000 |
| 32G3-2315 | 32G3-2315T | White | Incandescent | 14 | .10A | 10,000 |
| 32G18-2315 | 32G18-2315T | White | Incandescent | 28 | .04A | 7,000 |
| 32-2317 | 32-2317T | Clear | Neon | 125 | 1/3W | 25,000 |
| 32-2317 | 32-2317T | Clear | Neon | 250 | 1/3W | 25,000 |
| 32G1-2317 | 32G1-2317T | Clear | Incandescent | 6 | .20A | 5,000 |
| 32G3-2317 | 32G3-2317T | Clear | Incandescent | 14 | .10A | 10,000 |
| 32G18-2317 | 32G18-2317T | Clear | Incandescent | 28 | .04A | 7,000 |

Flush Lens Nickel Plated Bezel - Neon or Incandescent



Flush Lens Style
Without bezel.

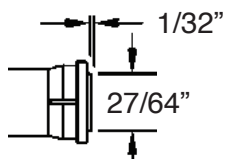

| Part Number 6" Wire Leads | Part Number 3/16" Tab Terminals | Lens Color | Lamp Type | Design Volts | Design Watts or Amps | Life (hrs) |
|------------------------------|------------------------------------|------------|--------------|--------------|-------------------------|------------|
| 32R-2311 | 32R-2311T | Red | Neon | 125 | 1/3W | 25,000 |
| 35R-2311 | 35R-2311T | Red | Neon | 250 | 1/3W | 25,000 |
| 32RG1-2311 | 32RG1-2311T | Red | Incandescent | 6 | .20A | 5,000 |
| 32RG3-2311 | 32RG3-2311T | Red | Incandescent | 14 | .10A | 10,000 |
| 32RG18-2311 | 32RG18-2311T | Red | Incandescent | 28 | .04A | 7,000 |
| 32R-2312 | 32R-2312T | Green | Neon | 125 | 1/3W | 25,000 |
| 35R-2312 | 35R-2312T | Green | Neon | 250 | 1/3W | 25,000 |
| 32RG1-2312 | 32RG1-2312T | Green | Incandescent | 6 | .20A | 5,000 |
| 32RG3-2312 | 32RG3-2312T | Green | Incandescent | 14 | .10A | 10,000 |
| 32RG18-2312 | 32RG18-2312T | Green | Incandescent | 28 | .04A | 7,000 |
| 32R-2313 | 32R-2313T | Amber | Neon | 125 | 1/3W | 25,000 |
| 35R-2313 | 35R-2313T | Amber | Neon | 250 | 1/3W | 25,000 |
| 32RG1-2313 | 32RG1-2313T | Amber | Incandescent | 6 | .20A | 5,000 |
| 32RG3-2313 | 32RG3-2313T | Amber | Incandescent | 14 | .10A | 10,000 |
| 32RG18-2313 | 32RG18-2313T | Amber | Incandescent | 28 | .04A | 7,000 |
| 32R-2314 | 32R-2314T | Blue | Neon | 125 | 1/3W | 25,000 |
| 35R-2314 | 35R-2314T | Blue | Neon | 250 | 1/3W | 25,000 |
| 32RG1-2314 | 32RG1-2314T | Blue | Incandescent | 6 | .20A | 5,000 |
| 32RG3-2314 | 32RG3-2314T | Blue | Incandescent | 14 | .10A | 10,000 |
| 32RG18-2314 | 32RG18-2314T | Blue | Incandescent | 28 | .04A | 7,000 |
| 32R-2315 | 32R-2315T | White | Neon | 125 | 1/3W | 25,000 |
| 35R-2315 | 35R-2315T | White | Neon | 250 | 1/3W | 25,000 |
| 32RG1-2315 | 32RG1-2315T | White | Incandescent | 6 | .20A | 5,000 |
| 32RG3-2315 | 32RG3-2315T | White | Incandescent | 14 | .10A | 10,000 |
| 32RG18-2315 | 32RG18-2315T | White | Incandescent | 28 | .04A | 7,000 |
| 32R-2317 | 32R-2317T | Clear | Neon | 125 | 1/3W | 25,000 |
| 32R-2317 | 32R-2317T | Clear | Neon | 250 | 1/3W | 25,000 |
| 32RG1-2317 | 32RG1-2317T | Clear | Incandescent | 6 | .20A | 5,000 |
| 32RG3-2317 | 32RG3-2317T | Clear | Incandescent | 14 | .10A | 10,000 |
| 32RG18-2317 | 32RG18-2317T | Clear | Incandescent | 28 | .04A | 7,000 |

Hi-Hat Lens without Bezel - Neon or Incandescent

Hi-Hat Lens Style
Without bezel.

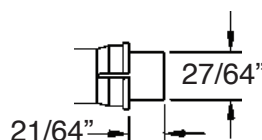

| Part Number 6" Wire Leads | Part Number 3/16" Tab Terminals | Lens Color | Lamp Type | Design Volts | Design Watts or Amps | Life (hrs) |
|------------------------------|------------------------------------|------------|--------------|--------------|-------------------------|------------|
| 32-2511 | 32-2511T | Red | Neon | 125 | 1/3W | 25,000 |
| 35-2511 | 35-2511T | Red | Neon | 250 | 1/3W | 25,000 |
| 32G1-2511 | 32G1-2511T | Red | Incandescent | 6 | .20A | 5,000 |
| 32G3-2511 | 32G3-2511T | Red | Incandescent | 14 | .10A | 10,000 |
| 32G18-2511 | 32G18-2511T | Red | Incandescent | 28 | .04A | 7,000 |
| 32-2512 | 32-2512T | Green | Neon | 125 | 1/3W | 25,000 |
| 35-2512 | 35-2512T | Green | Neon | 250 | 1/3W | 25,000 |
| 32G1-2512 | 32G1-2512T | Green | Incandescent | 6 | .20A | 5,000 |
| 32G3-2512 | 32G3-2512T | Green | Incandescent | 14 | .10A | 10,000 |
| 32G18-2512 | 32G18-2512T | Green | Incandescent | 28 | .04A | 7,000 |
| 32-2513 | 32-2513T | Amber | Neon | 125 | 1/3W | 25,000 |
| 35-2513 | 35-2513T | Amber | Neon | 250 | 1/3W | 25,000 |
| 32G1-2513 | 32G1-2513T | Amber | Incandescent | 6 | .20A | 5,000 |
| 32G3-2513 | 32G3-2513T | Amber | Incandescent | 14 | .10A | 10,000 |
| 32G18-2513 | 32G18-2513T | Amber | Incandescent | 28 | .04A | 7,000 |
| 32-2514 | 32-2514T | Blue | Neon | 125 | 1/3W | 25,000 |
| 35-2514 | 35-2514T | Blue | Neon | 250 | 1/3W | 25,000 |
| 32G1-2514 | 32G1-2514T | Blue | Incandescent | 6 | .20A | 5,000 |
| 32G3-2514 | 32G3-2514T | Blue | Incandescent | 14 | .10A | 10,000 |
| 32G18-2514 | 32G18-2514T | Blue | Incandescent | 28 | .04A | 7,000 |
| 32-2515 | 32-2515T | White | Neon | 125 | 1/3W | 25,000 |
| 35-2515 | 35-2515T | White | Neon | 250 | 1/3W | 25,000 |
| 32G1-2515 | 32G1-2515T | White | Incandescent | 6 | .20A | 5,000 |
| 32G3-2515 | 32G3-2515T | White | Incandescent | 14 | .10A | 10,000 |
| 32G18-2515 | 32G18-2515T | White | Incandescent | 28 | .04A | 7,000 |
| 32-2517 | 32-2517T | Clear | Neon | 125 | 1/3W | 25,000 |
| 32-2517 | 32-2517T | Clear | Neon | 250 | 1/3W | 25,000 |
| 32G1-2517 | 32G1-2517T | Clear | Incandescent | 6 | .20A | 5,000 |
| 32G3-2517 | 32G3-2517T | Clear | Incandescent | 14 | .10A | 10,000 |
| 32G18-2517 | 32G18-2517T | Clear | Incandescent | 28 | .04A | 7,000 |

Hi-Hat Lens Nickel Plated Bezel - Neon or Incandescent

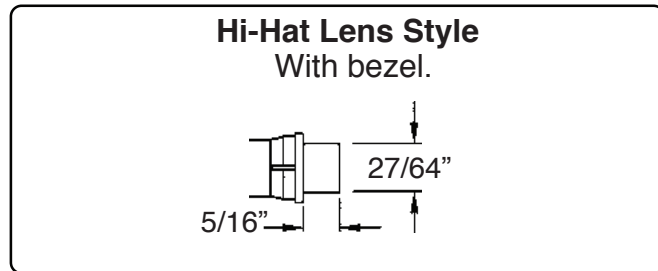

| Part Number 6" Wire Leads | Part Number 3/16" Tab Terminals | Lens Color | Lamp Type | Design Volts | Design Watts or Amps | Life (hrs) |
|------------------------------|------------------------------------|------------|--------------|--------------|-------------------------|------------|
| 32R-2511 | 32R-2511T | Red | Neon | 125 | 1/3W | 25,000 |
| 35R-2511 | 35R-2511T | Red | Neon | 250 | 1/3W | 25,000 |
| 32RG1-2511 | 32RG1-2511T | Red | Incandescent | 6 | .20A | 5,000 |
| 32RG3-2511 | 32RG3-2511T | Red | Incandescent | 14 | .10A | 10,000 |
| 32RG18-2511 | 32RG18-2511T | Red | Incandescent | 28 | .04A | 7,000 |
| 32R-2512 | 32R-2512T | Green | Neon | 125 | 1/3W | 25,000 |
| 35R-2512 | 35R-2512T | Green | Neon | 250 | 1/3W | 25,000 |
| 32RG1-2512 | 32RG1-2512T | Green | Incandescent | 6 | .20A | 5,000 |
| 32RG3-2512 | 32RG3-2512T | Green | Incandescent | 14 | .10A | 10,000 |
| 32RG18-2512 | 32RG18-2512T | Green | Incandescent | 28 | .04A | 7,000 |
| 32R-2513 | 32R-2513T | Amber | Neon | 125 | 1/3W | 25,000 |
| 35R-2513 | 35R-2513T | Amber | Neon | 250 | 1/3W | 25,000 |
| 32RG1-2513 | 32RG1-2513T | Amber | Incandescent | 6 | .20A | 5,000 |
| 32RG3-2513 | 32RG3-2513T | Amber | Incandescent | 14 | .10A | 10,000 |
| 32RG18-2513 | 32RG18-2513T | Amber | Incandescent | 28 | .04A | 7,000 |
| 32R-2514 | 32R-2514T | Blue | Neon | 125 | 1/3W | 25,000 |
| 35R-2514 | 35R-2514T | Blue | Neon | 250 | 1/3W | 25,000 |
| 32RG1-2514 | 32RG1-2514T | Blue | Incandescent | 6 | .20A | 5,000 |
| 32RG3-2514 | 32RG3-2514T | Blue | Incandescent | 14 | .10A | 10,000 |
| 32RG18-2514 | 32RG18-2514T | Blue | Incandescent | 28 | .04A | 7,000 |
| 32R-2515 | 32R-2515T | White | Neon | 125 | 1/3W | 25,000 |
| 35R-2515 | 35R-2515T | White | Neon | 250 | 1/3W | 25,000 |
| 32RG1-2515 | 32RG1-2515T | White | Incandescent | 6 | .20A | 5,000 |
| 32RG3-2515 | 32RG3-2515T | White | Incandescent | 14 | .10A | 10,000 |
| 32RG18-2515 | 32RG18-2515T | White | Incandescent | 28 | .04A | 7,000 |
| 32R-2517 | 32R-2517T | Clear | Neon | 125 | 1/3W | 25,000 |
| 32R-2517 | 32R-2517T | Clear | Neon | 250 | 1/3W | 25,000 |
| 32RG1-2517 | 32RG1-2517T | Clear | Incandescent | 6 | .20A | 5,000 |
| 32RG3-2517 | 32RG3-2517T | Clear | Incandescent | 14 | .10A | 10,000 |
| 32RG18-2517 | 32RG18-2517T | Clear | Incandescent | 28 | .04A | 7,000 |

Square Lens Nickel Plated Bezel - Neon or Incandescent

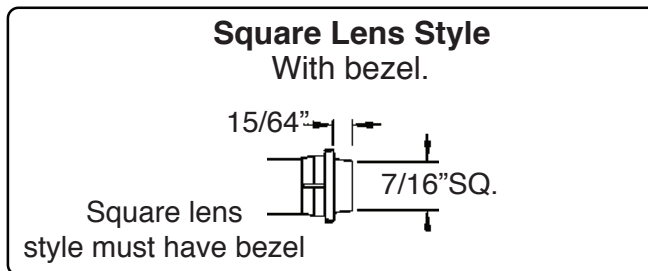

| Part Number 6" Wire Leads | Part Number 3/16" Tab Terminals | Lens Color | Lamp Type | Design Volts | Design Watts or Amps | Life (hrs) |
|------------------------------|------------------------------------|------------|--------------|--------------|-------------------------|------------|
| 32R-2911 | 32R-2911T | Red | Neon | 125 | 1/3W | 25,000 |
| 35R-2911 | 35R-2911T | Red | Neon | 250 | 1/3W | 25,000 |
| 32RG1-2911 | 32RG1-2911T | Red | Incandescent | 6 | .20A | 5,000 |
| 32RG3-2911 | 32RG3-2911T | Red | Incandescent | 14 | .10A | 10,000 |
| 32RG18-2911 | 32RG18-2911T | Red | Incandescent | 28 | .04A | 7,000 |
| 32R-2912 | 32R-2912T | Green | Neon | 125 | 1/3W | 25,000 |
| 35R-2912 | 35R-2912T | Green | Neon | 250 | 1/3W | 25,000 |
| 32RG1-2912 | 32RG1-2912T | Green | Incandescent | 6 | .20A | 5,000 |
| 32RG3-2912 | 32RG3-2912T | Green | Incandescent | 14 | .10A | 10,000 |
| 32RG18-2912 | 32RG18-2912T | Green | Incandescent | 28 | .04A | 7,000 |
| 32R-2913 | 32R-2913T | Amber | Neon | 125 | 1/3W | 25,000 |
| 35R-2913 | 35R-2913T | Amber | Neon | 250 | 1/3W | 25,000 |
| 32RG1-2913 | 32RG1-2913T | Amber | Incandescent | 6 | .20A | 5,000 |
| 32RG3-2913 | 32RG3-2913T | Amber | Incandescent | 14 | .10A | 10,000 |
| 32RG18-2913 | 32RG18-2913T | Amber | Incandescent | 28 | .04A | 7,000 |
| 32R-2914 | 32R-2914T | Blue | Neon | 125 | 1/3W | 25,000 |
| 35R-2914 | 35R-2914T | Blue | Neon | 250 | 1/3W | 25,000 |
| 32RG1-2914 | 32RG1-2914T | Blue | Incandescent | 6 | .20A | 5,000 |
| 32RG3-2914 | 32RG3-2914T | Blue | Incandescent | 14 | .10A | 10,000 |
| 32RG18-2914 | 32RG18-2914T | Blue | Incandescent | 28 | .04A | 7,000 |
| 32R-2915 | 32R-2915T | White | Neon | 125 | 1/3W | 25,000 |
| 35R-2915 | 35R-2915T | White | Neon | 250 | 1/3W | 25,000 |
| 32RG1-2915 | 32RG1-2915T | White | Incandescent | 6 | .20A | 5,000 |
| 32RG3-2915 | 32RG3-2915T | White | Incandescent | 14 | .10A | 10,000 |
| 32RG18-2915 | 32RG18-2915T | White | Incandescent | 28 | .04A | 7,000 |
| 32R-2917 | 32R-2917T | Clear | Neon | 125 | 1/3W | 25,000 |
| 32R-2917 | 32R-2917T | Clear | Neon | 250 | 1/3W | 25,000 |
| 32RG1-2917 | 32RG1-2917T | Clear | Incandescent | 6 | .20A | 5,000 |
| 32RG3-2917 | 32RG3-2917T | Clear | Incandescent | 14 | .10A | 10,000 |
| 32RG18-2917 | 32RG18-2917T | Clear | Incandescent | 28 | .04A | 7,000 |

Flashing Indicators Optional Nickel Plated Bezel

Neon lights are designed with outboard circuitry to provide a flashing action of about 100 times per minute. Flashers are ideal for applications where a warning indicator is desirable. 125 Volt Operation.

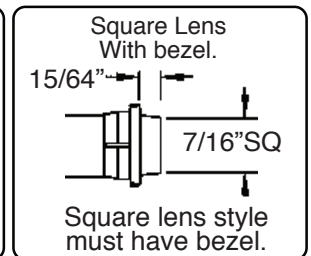
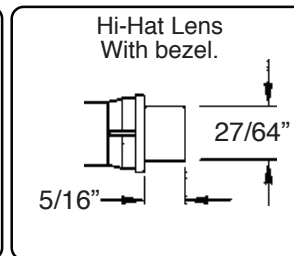
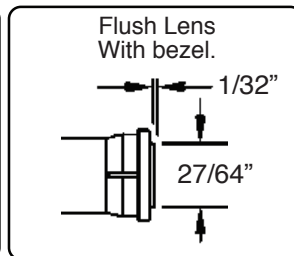
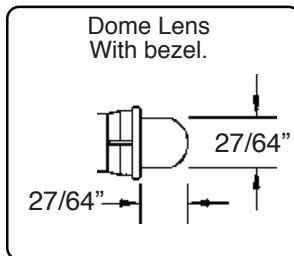
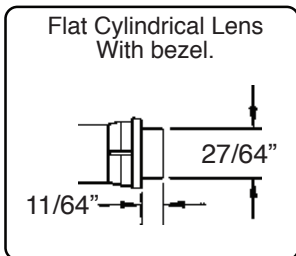

| Part Number Without Bezel | Part Number with Nickel Plated Bezel | Lens Color | Lamp Style | Design Volts | Design Watts or Amps | Life (hrs) |
|---------------------------|--------------------------------------|------------|------------------|--------------|----------------------|------------|
| 32FL-2111 | 32FLR-2111 | Red | Flat Cylindrical | 125 | 1/3W | 25,000 |
| 32FL-2112 | 32FLR-2112 | Green | Flat Cylindrical | 125 | 1/3W | 25,000 |
| 32FL-2113 | 32FLR-2113 | Amber | Flat Cylindrical | 125 | 1/3W | 25,000 |
| 32FL-2114 | 32FLR-2114 | Blue | Flat Cylindrical | 125 | 1/3W | 25,000 |
| 32FL-2115 | 32FLR-2115 | White | Flat Cylindrical | 125 | 1/3W | 25,000 |
| 32FL-2117 | 32FLR-2117 | Clear | Flat Cylindrical | 125 | 1/3W | 25,000 |
| 32FL-2211 | 32FLR-2211 | Red | Dome | 125 | 1/3W | 25,000 |
| 32FL-2212 | 32FLR-2212 | Green | Dome | 125 | 1/3W | 25,000 |
| 32FL-2213 | 32FLR-2213 | Amber | Dome | 125 | 1/3W | 25,000 |
| 32FL-2214 | 32FLR-2214 | Blue | Dome | 125 | 1/3W | 25,000 |
| 32FL-2215 | 32FLR-2215 | White | Dome | 125 | 1/3W | 25,000 |
| 32FL-2217 | 32FLR-2217 | Clear | Dome | 125 | 1/3W | 25,000 |
| 32FL-2311 | 32FLR-2311 | Red | Flush | 125 | 1/3W | 25,000 |
| 32FL-2312 | 32FLR-2312 | Green | Flush | 125 | 1/3W | 25,000 |
| 32FL-2313 | 32FLR-2313 | Amber | Flush | 125 | 1/3W | 25,000 |
| 32FL-2314 | 32FLR-2314 | Blue | Flush | 125 | 1/3W | 25,000 |
| 32FL-2315 | 32FLR-2315 | White | Flush | 125 | 1/3W | 25,000 |
| 32FL-2317 | 32FLR-2317 | Clear | Flush | 125 | 1/3W | 25,000 |
| 32FL-2511 | 32FLR-2511 | Red | Hi-Hat | 125 | 1/3W | 25,000 |
| 32FL-2512 | 32FLR-2512 | Green | Hi-Hat | 125 | 1/3W | 25,000 |
| 32FL-2513 | 32FLR-2513 | Amber | Hi-Hat | 125 | 1/3W | 25,000 |
| 32FL-2514 | 32FLR-2514 | Blue | Hi-Hat | 125 | 1/3W | 25,000 |
| 32FL-2515 | 32FLR-2515 | White | Hi-Hat | 125 | 1/3W | 25,000 |
| 32FL-2517 | 32FLR-2517 | Clear | Hi-Hat | 125 | 1/3W | 25,000 |
| N/A | 32FLR-2911 | Red | Square | 125 | 1/3W | 25,000 |
| N/A | 32FLR-2912 | Green | Square | 125 | 1/3W | 25,000 |
| N/A | 32FLR-2913 | Amber | Square | 125 | 1/3W | 25,000 |
| N/A | 32FLR-2914 | Blue | Square | 125 | 1/3W | 25,000 |
| N/A | 32FLR-2915 | White | Square | 125 | 1/3W | 25,000 |
| N/A | 32FLR-2917 | Clear | Square | 125 | 1/3W | 25,000 |

35XK Series - 600 Design Volts Neon Indicators - White Housing



Square lens style must have bezel.

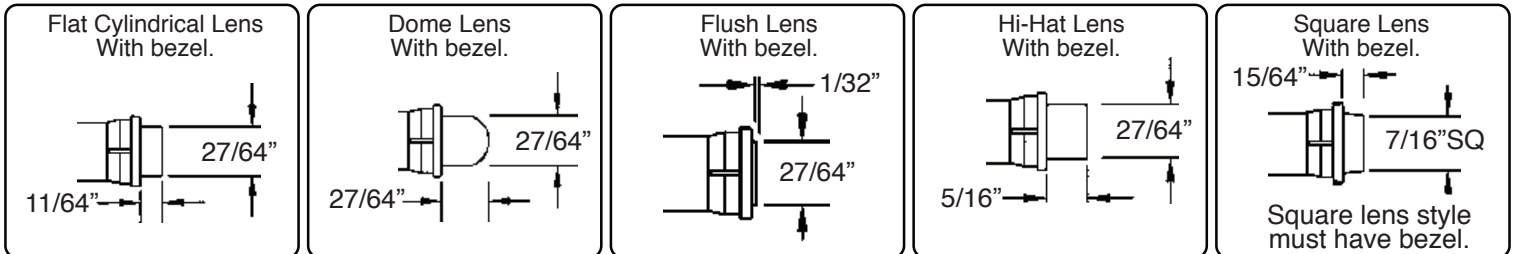

| Part Number Without Bezel | Part Number with Nickel Plated Bezel | Lens Color | Lamp Style | Design Volts | Design Watts | Life (hrs) |
|---------------------------|--------------------------------------|------------|------------------|--------------|--------------|------------|
| 35XK-2111 | 35RXK-2111 | Red | Flat Cylindrical | 600 | 1/3W | 25,000 |
| 35XK-2112 | 35RXK-2112 | Green | Flat Cylindrical | 600 | 1/3W | 25,000 |
| 35XK-2113 | 35RXK-2113 | Amber | Flat Cylindrical | 600 | 1/3W | 25,000 |
| 35XK-2114 | 35RXK-2114 | Blue | Flat Cylindrical | 600 | 1/3W | 25,000 |
| 35XK-2115 | 35RXK-2115 | White | Flat Cylindrical | 600 | 1/3W | 25,000 |
| 35XK-2117 | 35RXK-2117 | Clear | Flat Cylindrical | 600 | 1/3W | 25,000 |
| 35XK-2211 | 35RXK-2211 | Red | Dome | 600 | 1/3W | 25,000 |
| 35XK-2212 | 35RXK-2212 | Green | Dome | 600 | 1/3W | 25,000 |
| 35XK-2213 | 35RXK-2213 | Amber | Dome | 600 | 1/3W | 25,000 |
| 35XK-2214 | 35RXK-2214 | Blue | Dome | 600 | 1/3W | 25,000 |
| 35XK-2215 | 35RXK-2215 | White | Dome | 600 | 1/3W | 25,000 |
| 35XK-2217 | 35RXK-2217 | Clear | Dome | 600 | 1/3W | 25,000 |
| 35XK-2311 | 35RXK-2311 | Red | Flush | 600 | 1/3W | 25,000 |
| 35XK-2312 | 35RXK-2312 | Green | Flush | 600 | 1/3W | 25,000 |
| 35XK-2313 | 35RXK-2313 | Amber | Flush | 600 | 1/3W | 25,000 |
| 35XK-2314 | 35RXK-2314 | Blue | Flush | 600 | 1/3W | 25,000 |
| 35XK-2315 | 35RXK-2315 | White | Flush | 600 | 1/3W | 25,000 |
| 35XK-2317 | 35RXK-2317 | Clear | Flush | 600 | 1/3W | 25,000 |
| 35XK-2511 | 35RXK-2511 | Red | Hi-Hat | 600 | 1/3W | 25,000 |
| 35XK-2512 | 35RXK-2512 | Green | Hi-Hat | 600 | 1/3W | 25,000 |
| 35XK-2513 | 35RXK-2513 | Amber | Hi-Hat | 600 | 1/3W | 25,000 |
| 35XK-2514 | 35RXK-2514 | Blue | Hi-Hat | 600 | 1/3W | 25,000 |
| 35XK-2515 | 35RXK-2515 | White | Hi-Hat | 600 | 1/3W | 25,000 |
| 35XK-2517 | 35RXK-2517 | Clear | Hi-Hat | 600 | 1/3W | 25,000 |
| N/A | 35RXK-2911 | Red | Square | 600 | 1/3W | 25,000 |
| N/A | 35RXK-2912 | Green | Square | 600 | 1/3W | 25,000 |
| N/A | 35RXK-2913 | Amber | Square | 600 | 1/3W | 25,000 |
| N/A | 35RXK-2914 | Blue | Square | 600 | 1/3W | 25,000 |
| N/A | 35RXK-2915 | White | Square | 600 | 1/3W | 25,000 |
| N/A | 35RXK-2917 | Clear | Square | 600 | 1/3W | 25,000 |

L32/35 Series - LED Indicator Light White Housing 2 to 125 Design Volts



| Part Number With Flat Cylindrical Lens | Part Number With Dome Lens | Part Number With Flush Lens | Part Number With Hi-Hat Lens | Part Number With Square Lens | Lens Color | DC Design Volts *AC Design Volts |
|--|----------------------------|-----------------------------|------------------------------|------------------------------|------------|-------------------------------------|
| L32R-A2-2113 | L32R-A2-2213 | L32R-A2-2313 | L32R-A2-2513 | L32R-A2-2913 | Amber | 2 |
| L32R-A6-2113 | L32R-A6-2213 | L32R-A6-2313 | L32R-A6-2513 | L32R-A6-2913 | Amber | 6 |
| L32R-A12-2113 | L32R-A12-2213 | L32R-A12-2313 | L32R-A12-2513 | L32R-A12-2913 | Amber | 12 |
| L32R-A24-2113 | L32R-A24-2213 | L32R-A24-2313 | L32R-A24-2513 | L32R-A24-2913 | Amber | 24 |
| L32R-A125-2113 | L32R-A125-2213 | L32R-A125-2313 | L32R-A125-2513 | L32R-A125-2913 | Amber | 125* |
| L32R-G2-2112 | L32R-G2-2212 | L32R-G2-2312 | L32R-G2-2512 | L32R-G2-2912 | Green | 2 |
| L32R-G6-2112 | L32R-G6-2212 | L32R-G6-2312 | L32R-G6-2512 | L32R-G6-2912 | Green | 6 |
| L32R-G12-2112 | L32R-G12-2212 | L32R-G12-2312 | L32R-G12-2512 | L32R-G12-2912 | Green | 12 |
| L32R-G24-2112 | L32R-G24-2212 | L32R-G24-2312 | L32R-G24-2512 | L32R-G24-2912 | Green | 24 |
| L32R-G125-2112 | L32R-G125-2212 | L32R-G125-2312 | L32R-G125-2512 | L32R-G125-2912 | Green | 125* |
| L32R-R2-2111 | L32R-R2-2211 | L32R-R2-2311 | L32R-R2-2511 | L32R-R2-2911 | Red | 2 |
| L32R-R6-2111 | L32R-R6-2211 | L32R-R6-2311 | L32R-R6-2511 | L32R-R6-2911 | Red | 6 |
| L32R-R12-2111 | L32R-R12-2211 | L32R-R12-2311 | L32R-R12-2511 | L32R-R12-2911 | Red | 12 |
| L32R-R24-2111 | L32R-R24-2211 | L32R-R24-2311 | L32R-R24-2511 | L32R-R24-2911 | Red | 24 |
| L32R-R125-2111 | L32R-R125-2211 | L32R-R125-2311 | L32R-R125-2511 | L32R-R125-2911 | Red | 125* |
| L32R-Y2-2116 | L32R-Y2-2216 | L32R-Y2-2316 | L32R-Y2-2516 | L32R-Y2-2916 | Yellow | 2 |
| L32R-Y6-2116 | L32R-Y6-2216 | L32R-Y6-2316 | L32R-Y6-2516 | L32R-Y6-2916 | Yellow | 6 |
| L32R-Y12-2116 | L32R-Y12-2216 | L32R-Y12-2316 | L32R-Y12-2516 | L32R-Y12-2916 | Yellow | 12 |
| L32R-Y24-2116 | L32R-Y24-2216 | L32R-Y24-2316 | L32R-Y24-2516 | L32R-Y24-2916 | Yellow | 24 |
| L32R-Y125-2116 | L32R-Y125-2216 | L32R-Y125-2316 | L32R-Y125-2516 | L32R-Y125-2916 | Yellow | 125* |

Polarity Determination - Wire Leads: Red wire lead denotes anode(+); black wire lead denote cathode (-).

Terminals: One terminal is tin-plated to denote anode(+); unplated terminal refer to cathode(-)

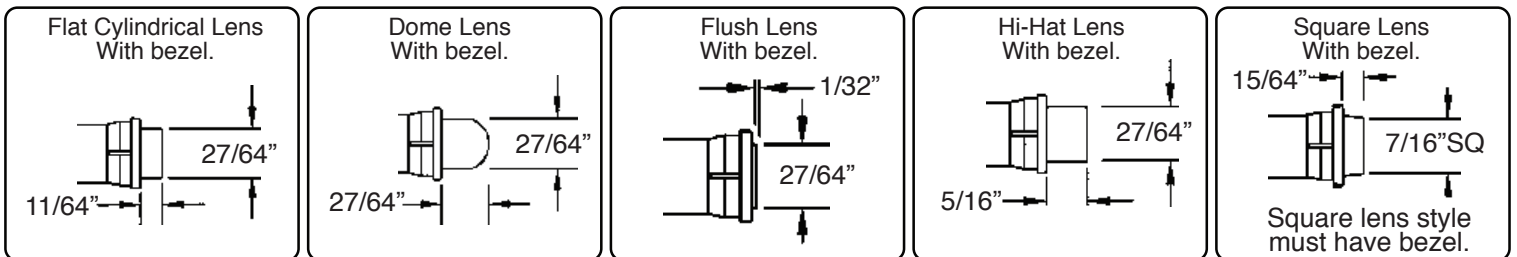

L32 Series - LED Indicator Light White Housing 2 to 24 Design Volts

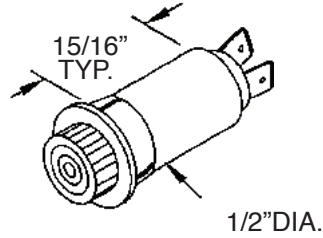

| Part Number With Flat Cylindrical Lens | Part Number With Dome Lens | Part Number With Flush Lens | Part Number With Hi-Hat Lens | Part Number With Square Lens | Lens Color | DC Design Volts |
|--|----------------------------|-----------------------------|------------------------------|------------------------------|------------|-----------------|
| L32R-A2-2113T | L32R-A2-2213T | L32R-A2-2313T | L32R-A2-2513T | L32R-A2-2913T | Amber | 2 |
| L32R-A6-2113T | L32R-A6-2213T | L32R-A6-2313T | L32R-A6-2513T | L32R-A6-2913T | Amber | 6 |
| L32R-A12-2113T | L32R-A12-2213T | L32R-A12-2313T | L32R-A12-2513T | L32R-A12-2913T | Amber | 12 |
| L32R-A24-2113T | L32R-A24-2213T | L32R-A24-2313T | L32R-A24-2513T | L32R-A24-2913T | Amber | 24 |
| L32R-A125-2112T | L32R-A125-2212T | L32R-A125-2312T | L32R-A125-2512T | L32R-A125-2912T | Green | 2 |
| L32R-G2-2112T | L32R-G2-2212T | L32R-G2-2312T | L32R-G2-2512T | L32R-G2-2912T | Green | 6 |
| L32R-G6-2112T | L32R-G6-2212T | L32R-G6-2312T | L32R-G6-2512T | L32R-G6-2912T | Green | 12 |
| L32R-G12-2112T | L32R-G12-2212T | L32R-G12-2312T | L32R-G12-2512T | L32R-G12-2912T | Green | 24 |
| L32R-G24-2111T | L32R-G24-2211T | L32R-G24-2311T | L32R-G24-2511T | L32R-G24-2911T | Red | 2 |
| L32R-G125-2111T | L32R-G125-2211T | L32R-G125-2311T | L32R-G125-2511T | L32R-G125-2911T | Red | 6 |
| L32R-R2-2111T | L32R-R2-2211T | L32R-R2-2311T | L32R-R2-2511T | L32R-R2-2911T | Red | 12 |
| L32R-R6-2111T | L32R-R6-2211T | L32R-R6-2311T | L32R-R6-2511T | L32R-R6-2911T | Red | 24 |
| L32R-R12-2116T | L32R-R12-2216T | L32R-R12-2316T | L32R-R12-2516T | L32R-R12-2916T | Yellow | 2 |
| L32R-R24-2116T | L32R-R24-2216T | L32R-R24-2316T | L32R-R24-2516T | L32R-R24-2916T | Yellow | 6 |
| L32R-R125-2116T | L32R-R125-2216T | L32R-R125-2316T | L32R-R125-2516T | L32R-R125-2916T | Yellow | 12 |
| L32R-Y2-2116T | L32R-Y2-2216T | L32R-Y2-2316T | L32R-Y2-2516T | L32R-Y2-2916T | Yellow | 24 |

Polarity Determination - Wire Leads: Red wire lead denotes anode(+); black wire lead denote cathode (-).
Terminals: One terminal is tin-plated to denote anode(+); unplated terminal refer to cathode(-)

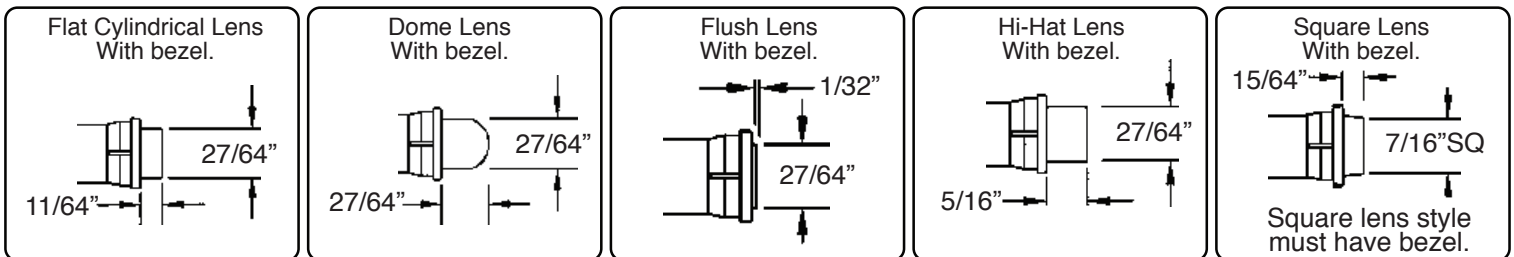



Компания «ЭлектроПласт» предлагает заключение долгосрочных отношений при поставках импортных электронных компонентов на взаимовыгодных условиях!

Наши преимущества:

- Оперативные поставки широкого спектра электронных компонентов отечественного и импортного производства напрямую от производителей и с крупнейших мировых складов;
- Поставка более 17-ти миллионов наименований электронных компонентов;
- Поставка сложных, дефицитных, либо снятых с производства позиций;
- Оперативные сроки поставки под заказ (от 5 рабочих дней);
- Экспресс доставка в любую точку России;
- Техническая поддержка проекта, помощь в подборе аналогов, поставка прототипов;
- Система менеджмента качества сертифицирована по Международному стандарту ISO 9001;
- Лицензия ФСБ на осуществление работ с использованием сведений, составляющих государственную тайну;
- Поставка специализированных компонентов (Xilinx, Altera, Analog Devices, Intersil, Interpoint, Microsemi, Aeroflex, Peregrine, Syfer, Eurofarad, Texas Instrument, Miteq, Cobham, E2V, MA-COM, Hittite, Mini-Circuits, General Dynamics и др.);

Помимо этого, одним из направлений компании «ЭлектроПласт» является направление «Источники питания». Мы предлагаем Вам помощь Конструкторского отдела:

- Подбор оптимального решения, техническое обоснование при выборе компонента;
- Подбор аналогов;
- Консультации по применению компонента;
- Поставка образцов и прототипов;
- Техническая поддержка проекта;
- Защита от снятия компонента с производства.



Как с нами связаться

Телефон: 8 (812) 309 58 32 (многоканальный)

Факс: 8 (812) 320-02-42

Электронная почта: org@eplast1.ru

Адрес: 198099, г. Санкт-Петербург, ул. Калинина, дом 2, корпус 4, литера А.