

Main

Range of product	Zelio Logic
Product or component type	Compact smart relay

Complementary

Local display	With
Number of control scheme lines	0...500 with FBD programming 0...240 with ladder programming
Cycle time	6...90 ms
Backup time	10 years at 77 °F (25 °C)
Clock drift	6 s/month at 77 °F (25 °C) 12 min/year at 32...131 °F (0...55 °C)
Checks	Program memory on each power up
[Us] rated supply voltage	24 V
Supply voltage limits	20.4...28.8 V
Supply frequency	50/60 Hz
Supply current	145 mA (without extension)
Power consumption in VA	4 VA without extension
Isolation voltage	1780 V
Protection type	Against inversion of terminals (control instructions not executed)
Discrete input number	8
Discrete input voltage	24 V AC
Discrete input current	4.4 mA
Discrete input frequency	47...53 Hz 57...63 Hz
Voltage state 1 guaranteed	≥ 14 V for discrete input
Voltage state 0 guaranteed	≤ 5 V for discrete input
Current state 1 guaranteed	≥ 2 mA for discrete input
Current state 0 guaranteed	≤ 0.5 mA for discrete input
Input impedance	4.6 kOhm (discrete input)
Number of outputs	4 relay output(s)
Output voltage limits	24...250 V AC 5...30 V DC (relay output)
Contacts type and composition	NO relay output
Output thermal current	8 A for all 4 outputs (relay output)
Electrical durability	500000 cycles AC-12 at 230 V, 1.5 A for relay output conforming to EN/IEC 60947-5-1 500000 cycles AC-15 at 230 V, 0.9 A for relay output conforming to EN/IEC 60947-5-1 500000 cycles DC-12 at 24 V, 1.5 A for relay output conforming to EN/IEC 60947-5-1 500000 cycles DC-13 at 24 V, 0.6 A for relay output conforming to EN/IEC 60947-5-1
Switching capacity in mA	≥ 10 mA at 12 V (relay output)
Operating rate in Hz	0.1 Hz (at Ie) for relay output 10 Hz (no load) for relay output
Mechanical durability	10000000 cycles (relay output)
[Uimp] rated impulse withstand voltage	4 kV conforming to EN/IEC 60947-1 and EN/IEC 60664-1
Clock	With

The information provided in this documentation contains general descriptions and/or technical characteristics of the performance of the products contained herein. This documentation is not intended as a substitute for and is not to be used for determining suitability or reliability of these products for specific user applications. It is the duty of any such user or integrator to perform the appropriate and complete risk analysis, evaluation and testing of the products with respect to the relevant specific application or use thereof. Neither Schneider Electric Industries SAS nor any of its affiliates or subsidiaries shall be responsible or liable for misuse of the information contained herein.

Response time	10 ms (from state 0 to state 1) relay output 5 ms (from state 1 to state 0) relay output 50 ms with ladder programming (from state 0 to state 1) discrete input 50 ms with ladder programming (from state 1 to state 0) discrete input 50...255 ms with FBD programming (from state 0 to state 1) discrete input 50...255 ms with FBD programming (from state 1 to state 0) discrete input
Connections - terminals	Screw terminals, clamping capacity: 1 x 0.2...1 x 2.5 mm ² AWG 25...AWG 14 semi-solid Screw terminals, clamping capacity: 1 x 0.2...1 x 2.5 mm ² AWG 25...AWG 14 solid Screw terminals, clamping capacity: 1 x 0.25...1 x 2.5 mm ² AWG 24...AWG 14 flexible with cable end Screw terminals, clamping capacity: 2 x 0.2...2 x 1.5 mm ² AWG 24...AWG 16 solid Screw terminals, clamping capacity: 2 x 0.25...2 x 0.75 mm ² AWG 24...AWG 18 flexible with cable end
Tightening torque	4.42 lbf.in (0.5 N.m)
Overvoltage category	III conforming to EN/IEC 60664-1
Product weight	0.55 lb(US) (0.25 kg)

Environment

immunity to microbreaks	<= 10 ms repeated 20 times
product certifications	CSA C-Tick GL GOST UL
standards	EN/IEC 60068-2-27 Ea EN/IEC 60068-2-6 Fc EN/IEC 61000-4-11 EN/IEC 61000-4-12 EN/IEC 61000-4-2 level 3 EN/IEC 61000-4-3 EN/IEC 61000-4-4 level 3 EN/IEC 61000-4-5 EN/IEC 61000-4-6 level 3
IP degree of protection	IP20 (terminal block) conforming to IEC 60529 IP40 (front panel) conforming to IEC 60529
environmental characteristic	EMC directive conforming to EN/IEC 61000-6-2 EMC directive conforming to EN/IEC 61000-6-3 EMC directive conforming to EN/IEC 61000-6-4 EMC directive conforming to EN/IEC 61131-2 zone B Low voltage directive conforming to EN/IEC 61131-2
disturbance radiated/conducted	Class B conforming to EN 55022-11 group 1
pollution degree	2 conforming to EN/IEC 61131-2
ambient air temperature for operation	-4...104 °F (-20...40 °C) in non-ventilated enclosure conforming to IEC 60068-2-1 and IEC 60068-2-2 -4...131 °F (-20...55 °C) conforming to IEC 60068-2-1 and IEC 60068-2-2
ambient air temperature for storage	-40...158 °F (-40...70 °C)
operating altitude	6561.68 ft (2000 m)
altitude transport	<= 10000 ft (3048 m)
relative humidity	95 % without condensation or dripping water

Offer Sustainability

WARNING: This product can expose you to chemicals including:	WARNING: This product can expose you to chemicals including:
Lead and lead compounds, which is known to the State of California to cause cancer and birth defects or other reproductive harm.	Lead and lead compounds, which is known to the State of California to cause cancer and birth defects or other reproductive harm.
For more information go to www.p65warnings.ca.gov	For more information go to www.p65warnings.ca.gov

Contractual warranty

Warranty period	18 months
-----------------	-----------

Compact and Modular Smart Relays

Mounting on 35 mm/1.38 in. DIN Rail

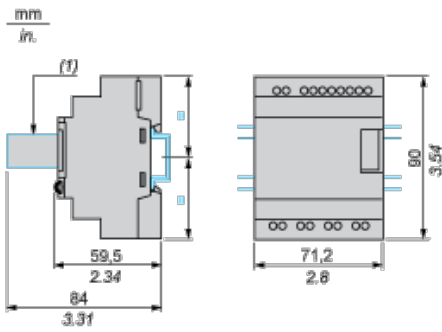

(1) With SR2USB01 or SR2BTC01

Screw Fixing (Retractable Lugs)

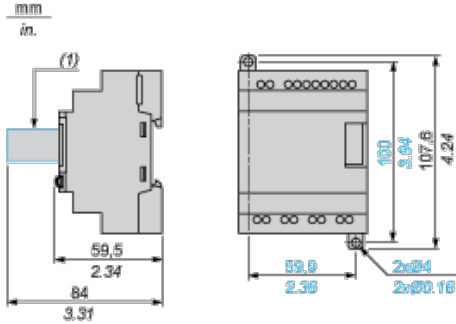

(1) With SR2USB01 or SR2BTC01

Position of Display

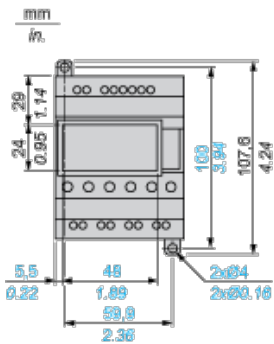

Connection of Smart Relays on AC Supply

SR...1B, SR...1FU

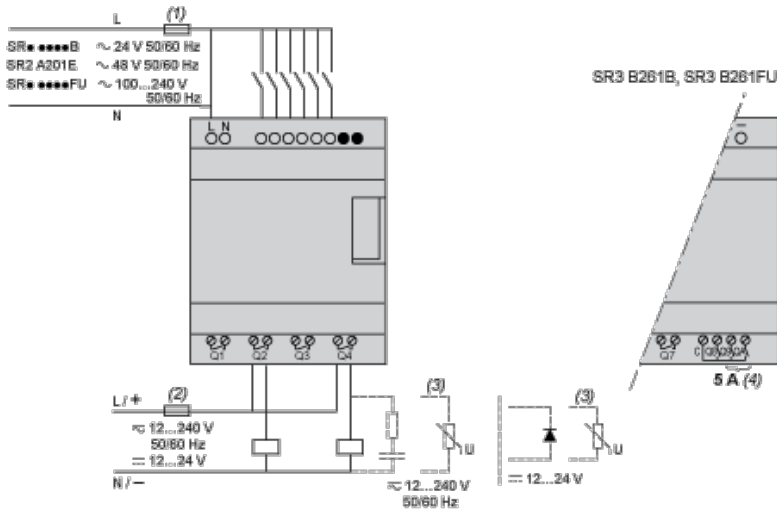

- (1) 1 A quick-blow fuse or circuit-breaker.
- (2) Fuse or circuit-breaker.
- (3) Inductive load.
- (4) Q9 and QA: 5 A (max. current in terminal C: 10 A).

With Discrete I/O Extension Module

SR3B...B + SR3XT...B, SR3B...FU + SR3XT...FU

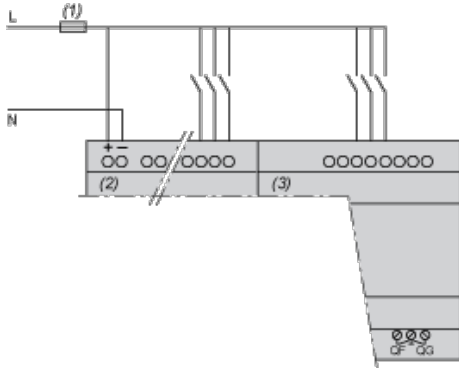

(1) 1 A quick-blow fuse or circuit-breaker.

NOTE: QF and QG: 5 A for SR3XT141..

Compact and Modular Smart Relays

Electrical Durability of Relay Outputs

(in millions of operating cycles, conforming to IEC/EN 60947-5-1)

AC-12 (1)

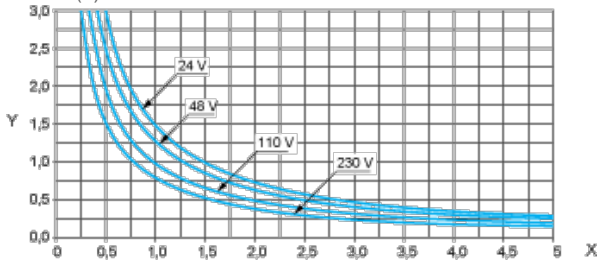

X: Current (A)

Y: Millions of operating cycles

(1) AC-12: switching resistive loads and opto-coupler isolated solid-state loads, $\cos \geq 0.9$.

AC-14 (1)

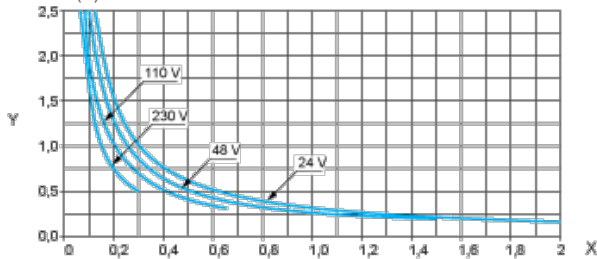

X: Current (A)

Y: Millions of operating cycles

(1) AC-14: switching small electromagnetic loads ≤ 72 VA, make: $\cos = 0.3$, break: $\cos = 0.3$.

AC-15 (1)

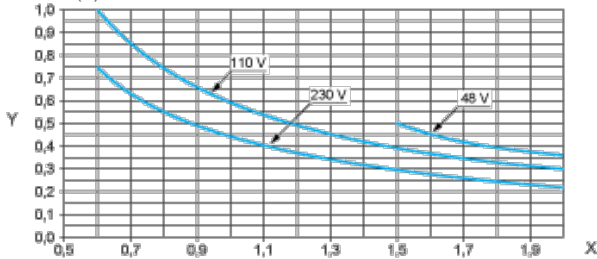

X: Current (A)

Y: Millions of operating cycles

(1) AC-15: switching electromagnetic loads ≥ 72 VA, make: $\cos = 0.7$, break: $\cos = 0.4$.



Компания «ЭлектроПласт» предлагает заключение долгосрочных отношений при поставках импортных электронных компонентов на взаимовыгодных условиях!

Наши преимущества:

- Оперативные поставки широкого спектра электронных компонентов отечественного и импортного производства напрямую от производителей и с крупнейших мировых складов;
- Поставка более 17-ти миллионов наименований электронных компонентов;
- Поставка сложных, дефицитных, либо снятых с производства позиций;
- Оперативные сроки поставки под заказ (от 5 рабочих дней);
- Экспресс доставка в любую точку России;
- Техническая поддержка проекта, помощь в подборе аналогов, поставка прототипов;
- Система менеджмента качества сертифицирована по Международному стандарту ISO 9001;
- Лицензия ФСБ на осуществление работ с использованием сведений, составляющих государственную тайну;
- Поставка специализированных компонентов (Xilinx, Altera, Analog Devices, Intersil, Interpoint, Microsemi, Aeroflex, Peregrine, Syfer, Eurofarad, Texas Instrument, Miteq, Cobham, E2V, MA-COM, Hittite, Mini-Circuits, General Dynamics и др.);

Помимо этого, одним из направлений компании «ЭлектроПласт» является направление «Источники питания». Мы предлагаем Вам помощь Конструкторского отдела:

- Подбор оптимального решения, техническое обоснование при выборе компонента;
- Подбор аналогов;
- Консультации по применению компонента;
- Поставка образцов и прототипов;
- Техническая поддержка проекта;
- Защита от снятия компонента с производства.



Как с нами связаться

Телефон: 8 (812) 309 58 32 (многоканальный)

Факс: 8 (812) 320-02-42

Электронная почта: org@eplast1.ru

Адрес: 198099, г. Санкт-Петербург, ул. Калинина, дом 2, корпус 4, литера А.