

Pb-free
HEAT



PS1102HA

Surface Mount Phototransistor/2125 Type

Features

Package	2125 Type, Water clear epoxy
Product features	<ul style="list-style-type: none">• Outer Dimension 2.0 x 1.25 x 0.8mm (L x W x H)• Small Size• Photo Current : 2mA TYP. ($V_{CE}=5V, E_e=5mW/cm^2$)• Wide Distribution• Lead-free soldering compatible• RoHS compliant
Peak Sensitivity Wavelength	880nm
Half Intensity Angle	$\theta_x = 130 \text{ deg.}, \theta_y = 135 \text{ deg.}$
Die materials	Si
Rank grouping parameter	Sorted by photo current per rank taping
Assembly method	Auto pick & place machine (Auto Mounter)
Soldering methods	Reflow soldering, and manual soldering ※Please refer to Soldering Conditions about soldering.
Taping and reel	4,000pcs per reel in a 8mm width tape. (Standard) Reel diameter: $\phi 180mm$
ESD	2kV (HBM)

Recommended Applications

Car Audio, Electric Household Appliances, OA/FA, PC/Peripheral Equipment, Other General Applications

Absolute Maximum Ratings

(Ta=25°C)

Item	Symbol	Absolute Maximum Ratings	Unit
Collector Dissipation	P _c	75	mW
Collector-Emitter Voltage	V _{CEO}	30	V
Emitter-Collector Voltage	V _{ECO}	5	V
Collector Current	I _c	20	mA
Operating Temperature	T _{opr}	-30~+85	°C
Storage Temperature	T _{stg}	-40~+90	°C

Electro-Optical Characteristics

(Ta=25°C)

Item	Conditions	Symbol	Characteristics		Unit
			Min.	TYP.	
Photo Current	V _{CE} =5V, E _e =5mW/cm ² ※1	I _c	0.4		mA
			2		mA
Response Time	V _{CE} =10V, I _c =2mA, R _L =100Ω	tr/tf	8/9		μs
Dark Current	V _{CEO} =10V	I _{CEO}	0.1		μA
Peak Sensitivity Wavelength	V _{CE} =5V	λ _p	880		nm
Spatial Half Width	V _{CE} =5V	Δθ	TYP.	130(θ _x)	deg.
				135(θ _y)	

※1 Color temperature is 2,856K. Employs a standard tungsten lamp.

Photo Current Rank

(Ta=25°C)

Rank	Ic(mA)		Condition
	MIN.	MAX.	
A	0.4	0.8	$V_{CE} = 5V$ $E_e = 5mW/cm^2$
B	0.7	1.4	
C	1.2	2.4	
D	2.1	4.2	
E	3.6	7.2	

※Please contact our sales staff concerning rank designation.

Technical Data

Relative Sensitivity vs. Sensitivity Wavelength
Condition : $T_a = 25^\circ\text{C}$, $V_{CE} = 5\text{V}$

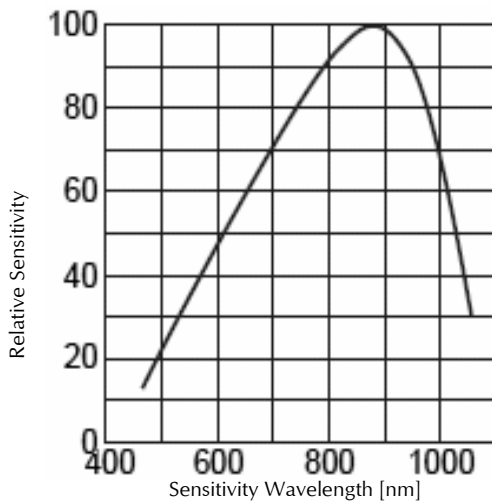

Spatial Distribution Example

Condition : $T_a = 25^\circ\text{C}$

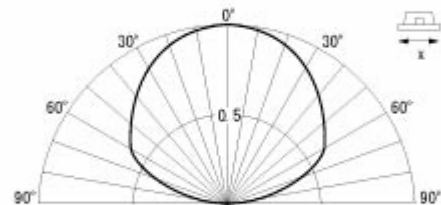

Radiation Luminance vs. Relative Photo Current
Condition : $T_a = 25^\circ\text{C}$, $V_{CE} = 5\text{V}$

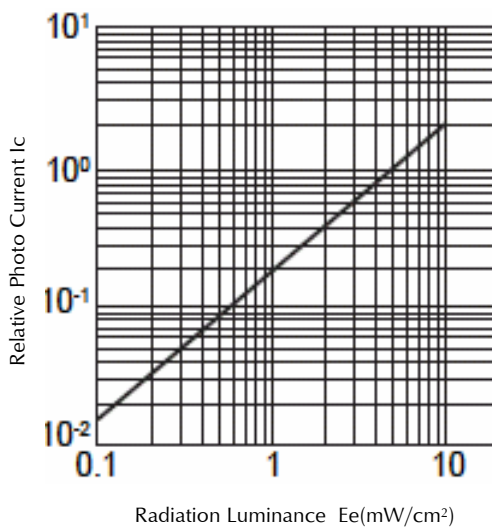

It is based on $E_e = 5\text{mW/cm}^2$.
Employs a standard tungsten lamp of 2,856K.

Collector-Emitter Voltage vs. Photo Current
Condition : $T_a = 25^\circ\text{C}$

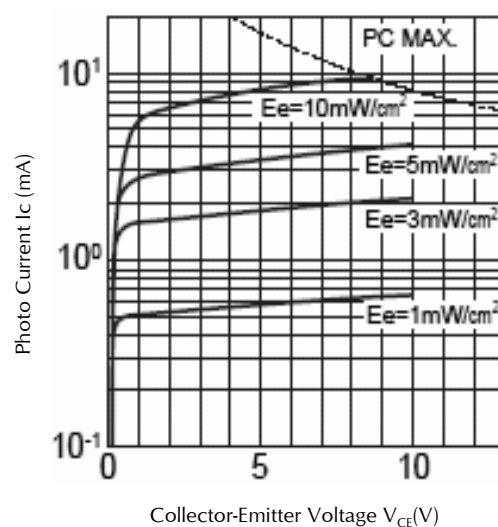

Employs a standard tungsten lamp of 2,856K.

Technical Data

Response Time Measuring Circuit

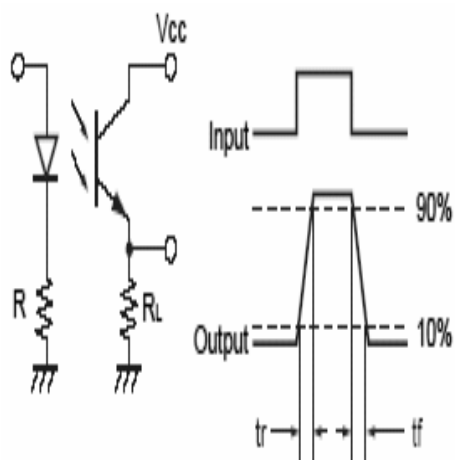

Load Resistance vs. Response Time

Condition : $V_{CE}=10V$, $I_C=2mA$, $T_a=25^\circ C$

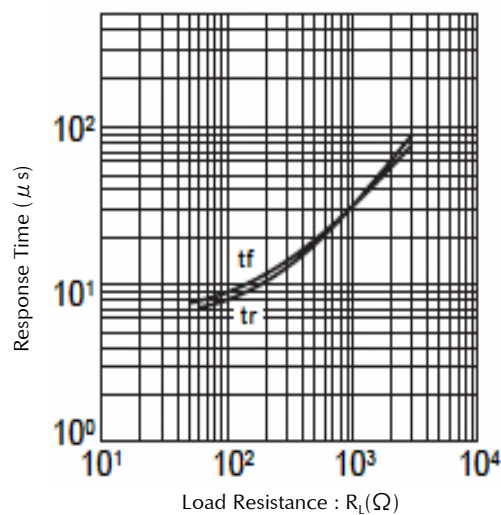

Ambient Temperature vs. Collector Dissipation

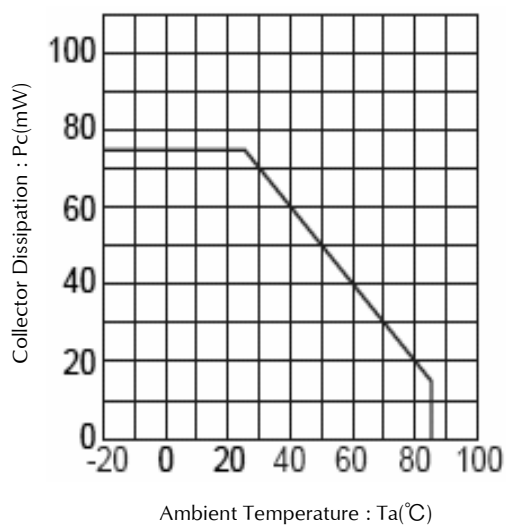

Ambient Temperature vs. Dark Current

Condition : $V_{CE0} = 10V$

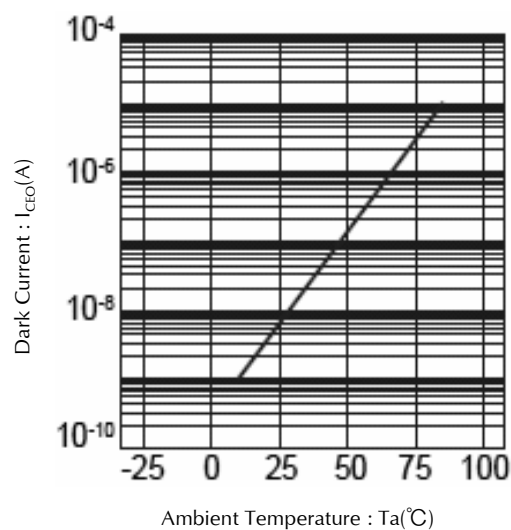

Technical Data

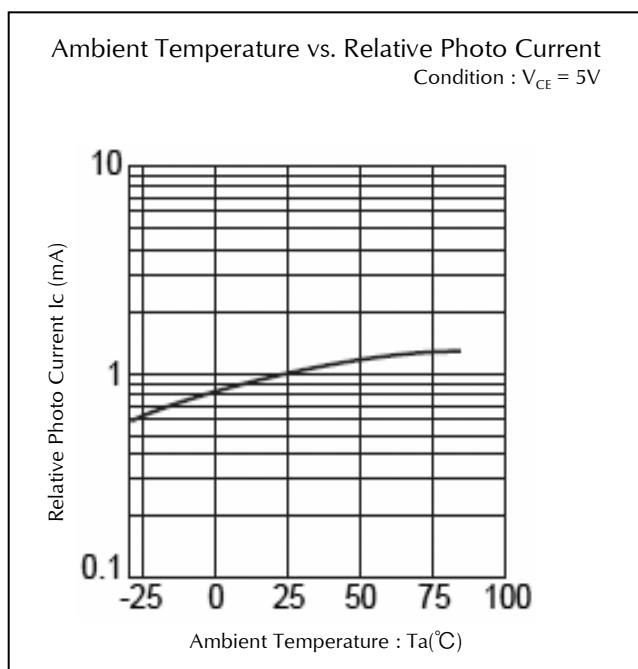

Package Dimensions

(Unit: mm)

Weight: (2.84)mg

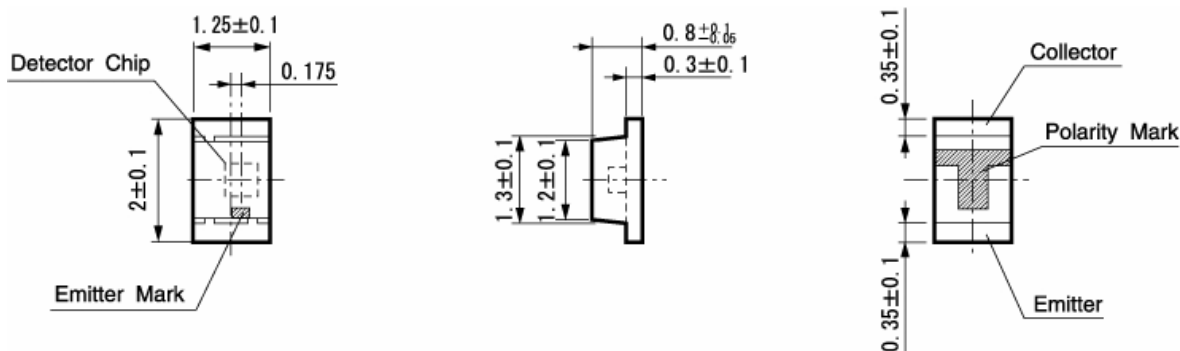

Recommended Soldering Pattern

(Unit: mm)

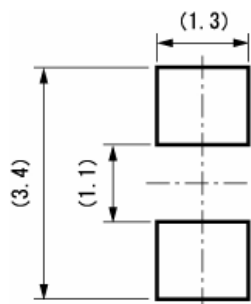

Taping Specification

(Unit: mm)

Quantity: 4,000pcs/ reel (standard)

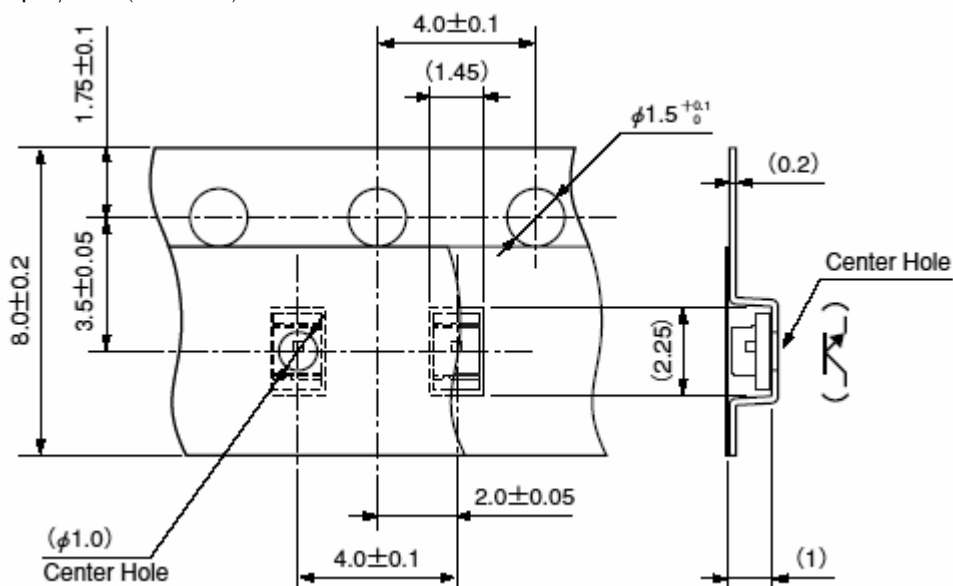

Reflow Soldering Conditions

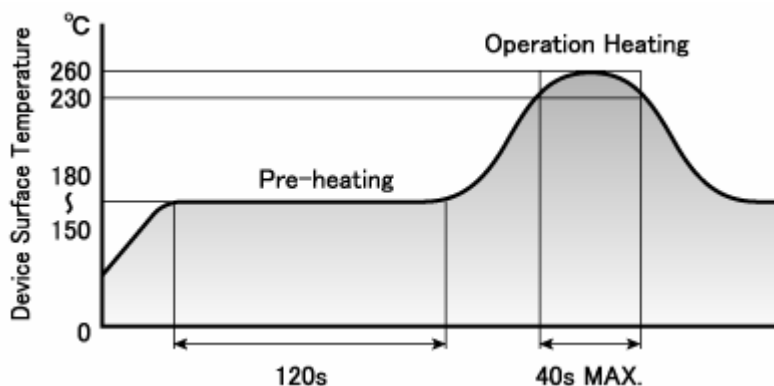

- 1) The above profile temperature gives the maximum temperature of the device resin surface. Please set the temperature so as to avoid exceeding this range.
- 2) Total times of reflow soldering process shall be no more than 2 times. When the second reflow soldering process is performed, intervals between the first and second reflow should be short as possible (while allowing some time for the component to return to normal temperature after the first reflow) in order to prevent the device from absorbing moisture.
- 3) Temperature fluctuation to the device during the pre-heating process shall be minimized.

Manual Soldering Conditions

Iron tip temp.	350 °C	(MAX.) (30 W Max.)
Soldering time and frequency	3 s	(MAX.)
	1 time	(MAX.)

Reliability Testing Result

Reliability Testing Result	Applicable Standard	Testing Conditions	Duration	Failure
Room Temp. Operating Life	EIAJ ED-4701/100(101)	Ta = 25°C, Pc = Maximum Rated Power Dissipation	1,000 h	0/16
Resistance to Soldering Heat	EIAJ ED-4701/300(301)	(Pretreatment) Individual standard (Reflow Soldering) Pre-heating 150°C~180°C 120s Operating Heating 230°C Min. Peak temperature 260°C	Twice	0/16
Temperature Cycling	EIAJ ED-4701/100(105)	Minimum Rated Storage Temperature(30min) ~Normal Temperature(15min) ~Maximum Rated Storage Temperature(30min) ~Normal Temperature(15min)	5 cycles	0/16
Wet High Temp. Storage Life	EIAJ ED-4701/100(103)	Ta = 60 ± 2°C, RH = 90 ± 5%	1,000 h	0/16
High Temp. Storage Life	EIAJ ED-4701/200(201)	Ta = Maximum Rated Storage Temperature	1,000 h	0/16
Low Temp. Storage Life	EIAJ ED-4701/200(202)	Ta = Minimum Rated Storage Temperature	1,000 h	0/16
Vibration, Variable Frequency	EIAJ ED-4701/400(403)	98.1m/s ² (10G), 100 ~ 2KHz sweep for 20min., XYZ each direction	2 h	0/16

Failure Criteria

Items	Symbols	Conditions	Failure criteria
Photo Current	I _c	E _E Value of each product Irradiance of Photo Current V _{CE} Value of each product Collector-emitter Voltage of Photo Current	Testing Max. Value ≥ Initial Value x 1.3 Testing Min. Value ≤ Initial Value x 0.7
Dark Current	I _{CEO}	V _{CEO} Value of each product Collector-emitter Voltage of Dark Current	Testing Max. Value ≥ Spec. Max. Value x 1.2

Special Notice to Customers Using the Products and Technical Information Shown in This Data Sheet

- 1) The technical information shown in the data sheets are limited to the typical characteristics and circuit examples of the referenced products. It does not constitute the warranting of industrial property nor the granting of any license.
- 2) For the purpose of product improvement, the specifications, characteristics and technical data described in the data sheets are subject to change without prior notice. Therefore it is recommended that the most updated specifications be used in your design.
- 3) When using the products described in the data sheets, please adhere to the maximum ratings for operating voltage, heat dissipation characteristics, and other precautions for use. We are not responsible for any damage which may occur if these specifications are exceeded.
- 4) The products that have been described to this catalog are manufactured so that they will be used for the electrical instrument of the benchmark (OA equipment, telecommunications equipment, AV machine, home appliance and measuring instrument).
The application of aircrafts, space borne application, transportation equipment, medical equipment and nuclear power control equipment, etc. needs a high reliability and safety, and the breakdown and the wrong operation might influence the life or the human body. Please consult us beforehand if you plan to use our product for the usages of aircrafts, space borne application, transportation equipment, medical equipment and nuclear power control equipment, etc. except OA equipment, telecommunications equipment, AV machine, home appliance and measuring instrument.
- 5) In order to export the products or technologies described in this data sheet which are under the "Foreign Exchange and Foreign Trade Control Law," it is necessary to first obtain an export permit from the Japanese government.
- 6) No part of this data sheet may be reprinted or reproduced without prior written permission from Stanley Electric Co., Ltd.
- 7) The most updated edition of this data sheet can be obtained from the address below:
<http://www.stanley-components.com>



Компания «ЭлектроПласт» предлагает заключение долгосрочных отношений при поставках импортных электронных компонентов на взаимовыгодных условиях!

Наши преимущества:

- Оперативные поставки широкого спектра электронных компонентов отечественного и импортного производства напрямую от производителей и с крупнейших мировых складов;
- Поставка более 17-ти миллионов наименований электронных компонентов;
- Поставка сложных, дефицитных, либо снятых с производства позиций;
- Оперативные сроки поставки под заказ (от 5 рабочих дней);
- Экспресс доставка в любую точку России;
- Техническая поддержка проекта, помощь в подборе аналогов, поставка прототипов;
- Система менеджмента качества сертифицирована по Международному стандарту ISO 9001;
- Лицензия ФСБ на осуществление работ с использованием сведений, составляющих государственную тайну;
- Поставка специализированных компонентов (Xilinx, Altera, Analog Devices, Intersil, Interpoint, Microsemi, Aeroflex, Peregrine, Syfer, Eurofarad, Texas Instrument, Miteq, Cobham, E2V, MA-COM, Hittite, Mini-Circuits, General Dynamics и др.);

Помимо этого, одним из направлений компании «ЭлектроПласт» является направление «Источники питания». Мы предлагаем Вам помощь Конструкторского отдела:

- Подбор оптимального решения, техническое обоснование при выборе компонента;
- Подбор аналогов;
- Консультации по применению компонента;
- Поставка образцов и прототипов;
- Техническая поддержка проекта;
- Защита от снятия компонента с производства.



Как с нами связаться

Телефон: 8 (812) 309 58 32 (многоканальный)

Факс: 8 (812) 320-02-42

Электронная почта: org@eplast1.ru

Адрес: 198099, г. Санкт-Петербург, ул. Калинина, дом 2, корпус 4, литера А.