

ANGELETTE-M-B

~50° medium beam compatible with BJB connectors

TECHNICAL SPECIFICATIONS:

Dimensions	Ø 110.0 mm
Height	57.3 mm
Fastening	socket
ROHS compliant	yes ⓘ

MATERIAL SPECIFICATIONS:

Component	Type	Material	Colour	Finish	Coating
ANGELETTE-M-B	Reflector	PC	metal		



ORDERING INFORMATION:

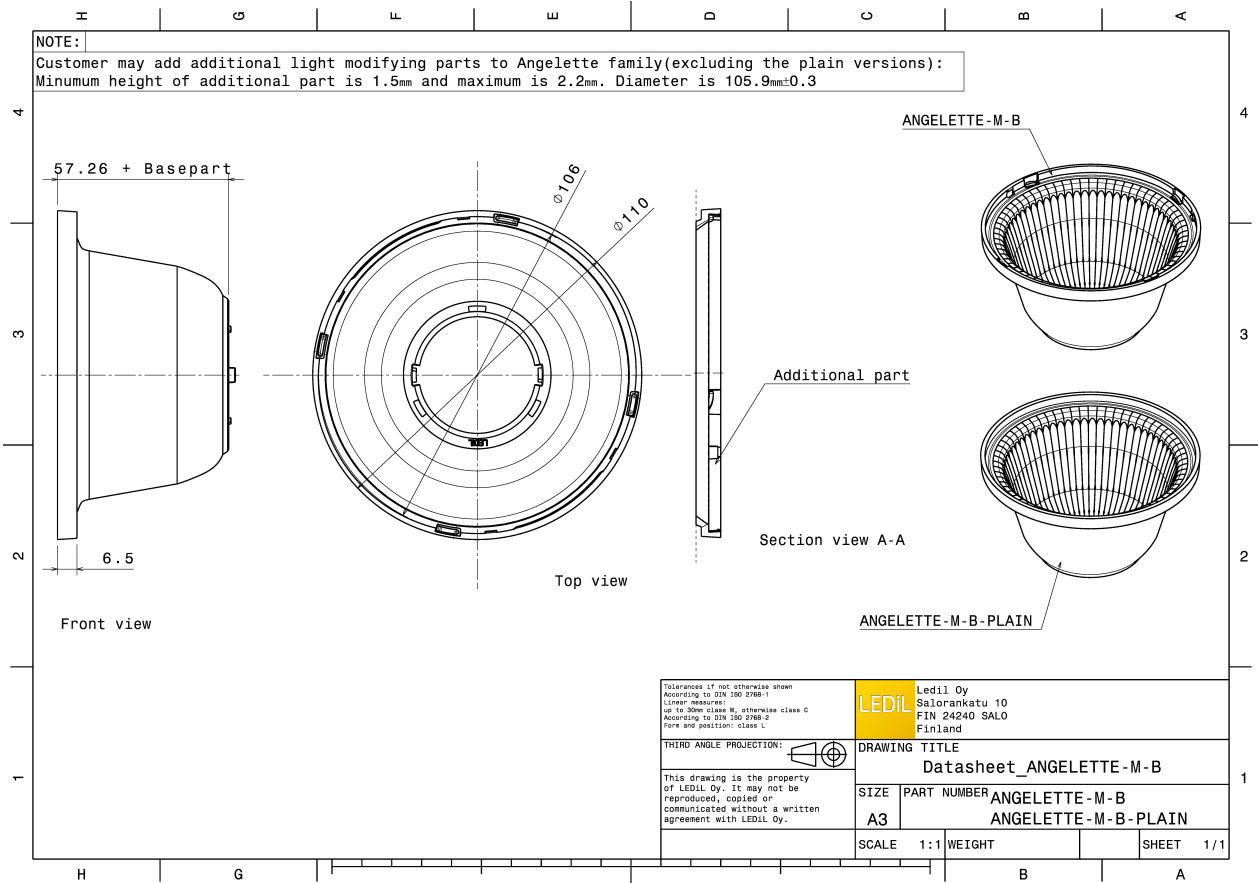

Component	Qty in box	MOQ	MPQ	Box weight (kg)
F14617_ANGELETTE-M-B » Box size: 398 x 298 x 265 mm	160	80	40	7.3

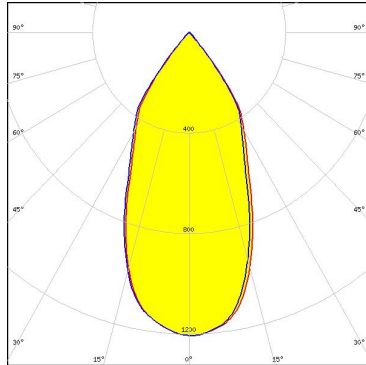
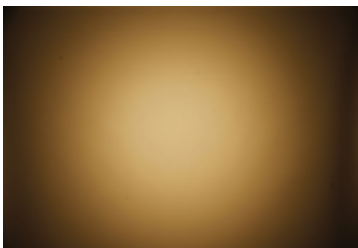
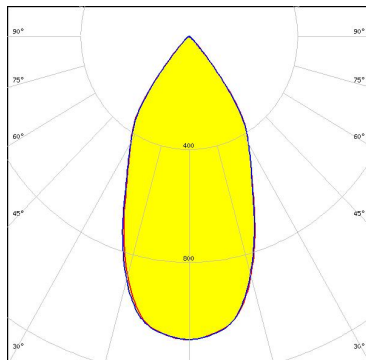
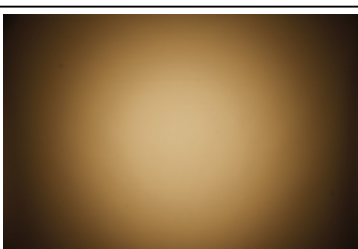
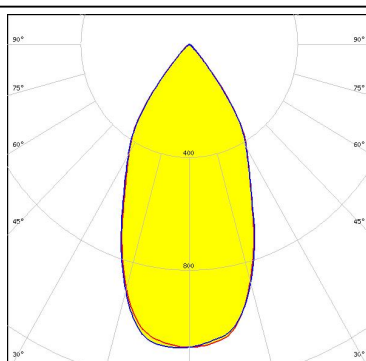
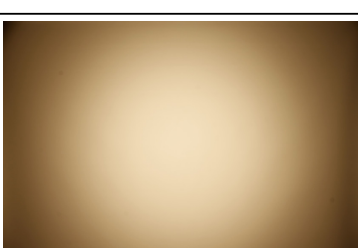
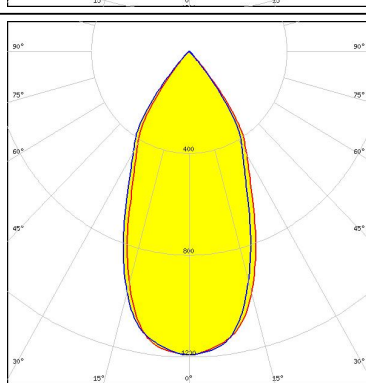

PHOTOMETRIC DATA (MEASURED):

<p>bridgelux.</p> <p>LED V15 Gen6</p> <p>FWHM 48.0°</p> <p>Efficiency 88 %</p> <p>Peak intensity 1.2 cd/lm</p> <p>LEDs/each optic 1</p> <p>Light colour White</p> <p>Required components: BJB: 47.319.2224</p>		
<p>bridgelux.</p> <p>LED V15 Gen6</p> <p>FWHM 51.0°</p> <p>Efficiency 85 %</p> <p>Peak intensity 1.1 cd/lm</p> <p>LEDs/each optic 1</p> <p>Light colour White</p> <p>Required components: F13671_ANGE-RZ-LENS BJB: 47.319.2224</p>		
<p>bridgelux.</p> <p>LED V18 Gen6</p> <p>FWHM 51.0°</p> <p>Efficiency 85 %</p> <p>Peak intensity 1.1 cd/lm</p> <p>LEDs/each optic 1</p> <p>Light colour White</p> <p>Required components: F13671_ANGE-RZ-LENS BJB: 47.319.2274</p>		
<p>bridgelux.</p> <p>LED V18 Gen6</p> <p>FWHM 48.0°</p> <p>Efficiency 88 %</p> <p>Peak intensity 1.2 cd/lm</p> <p>LEDs/each optic 1</p> <p>Light colour White</p> <p>Required components: BJB: 47.319.2274</p>		

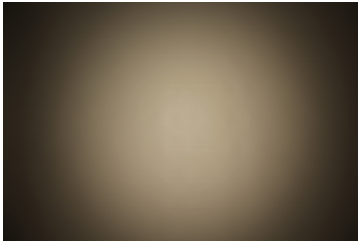
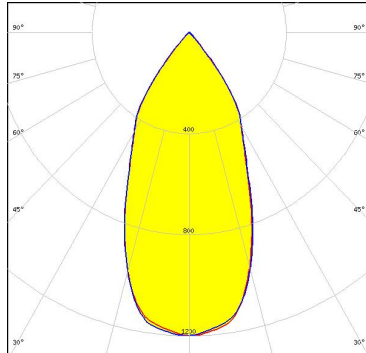
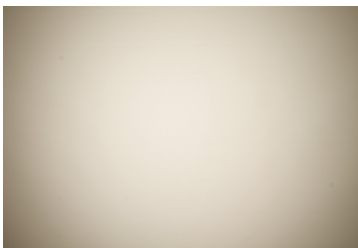
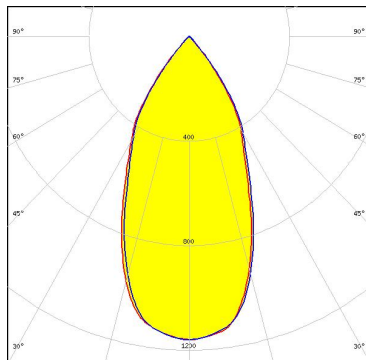
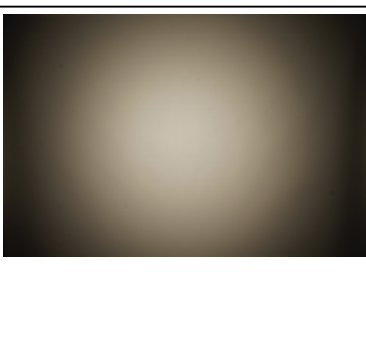
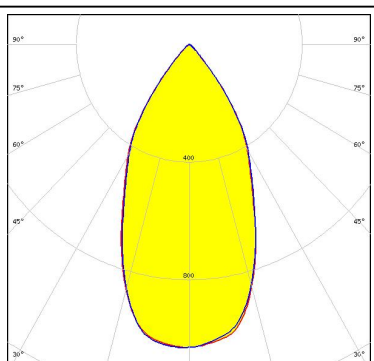
PHOTOMETRIC DATA (MEASURED):

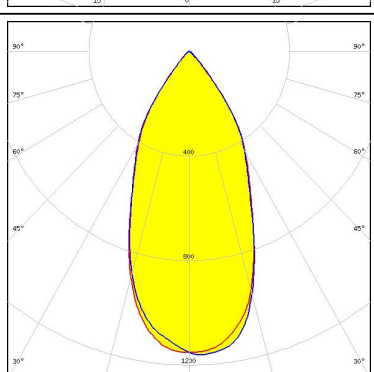
<p>bridgelux.</p> <p>LED V18 Gen7</p> <p>FWHM 48.0°</p> <p>Efficiency 89 %</p> <p>Peak intensity 1.2 cd/lm</p> <p>LEDs/each optic 1</p> <p>Light colour White</p> <p>Required components: BJB: 47.319.2350</p>		
<p>bridgelux.</p> <p>LED V22 Gen6</p> <p>FWHM 49.0°</p> <p>Efficiency 86 %</p> <p>Peak intensity 1.2 cd/lm</p> <p>LEDs/each optic 1</p> <p>Light colour White</p> <p>Required components: A.A.G. STUCCHI: 8102/G2</p>		
<p>bridgelux.</p> <p>LED V22 Gen6</p> <p>FWHM 52.0°</p> <p>Efficiency 82 %</p> <p>Peak intensity 1 cd/lm</p> <p>LEDs/each optic 1</p> <p>Light colour White</p> <p>Required components: F13671_ANGE-RZ-LENS A.A.G. STUCCHI: 8102/G2</p>		
<p>CITIZEN</p> <p>LED CLL03x/CLU03x</p> <p>FWHM 48.0°</p> <p>Efficiency 86 %</p> <p>Peak intensity 1.2 cd/lm</p> <p>LEDs/each optic 1</p> <p>Light colour White</p> <p>Required components: F15412_ANGELETTE-DL BJB: 47.319.2021</p>		

PHOTOMETRIC DATA (MEASURED):

CITIZEN

LED CLL03x/CLU03x
 FWHM 47.0°
 Efficiency 86 %
 Peak intensity 1.2 cd/lm
 LEDs/each optic 1
 Light colour White
 Required components:
 F15176_ANGELETTE-LENS
 BJB: 47.319.2021

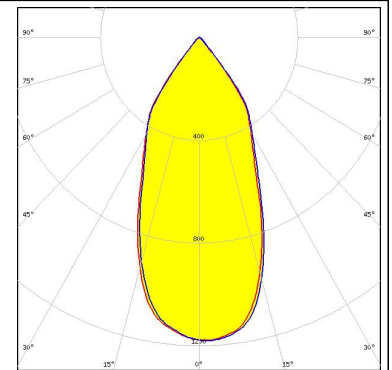

CITIZEN

LED CLL03x/CLU03x
 FWHM 47.0°
 Efficiency 89 %
 Peak intensity 1.2 cd/lm
 LEDs/each optic 1
 Light colour White
 Required components:
 BJB: 47.319.2021

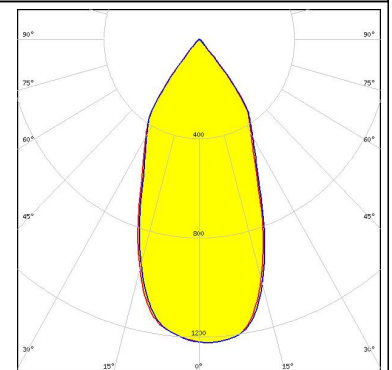
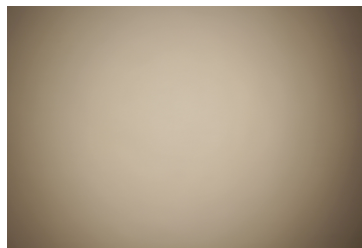

CITIZEN

LED CLL03x/CLU03x
 FWHM 47.0°
 Efficiency 88 %
 Peak intensity 1.2 cd/lm
 LEDs/each optic 1
 Light colour White
 Required components:
 A.A.G. STUCCHI: 8101/G2

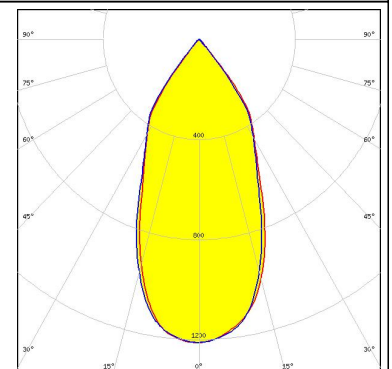
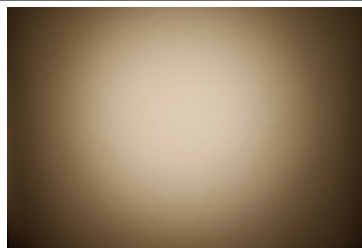

CITIZEN

LED CLL03x/CLU03x
 FWHM 51.0°
 Efficiency 83 %
 Peak intensity 1 cd/lm
 LEDs/each optic 1
 Light colour White
 Required components:
 F13671_ANGE-RZ-LENS
 A.A.G. STUCCHI: 8101/G2

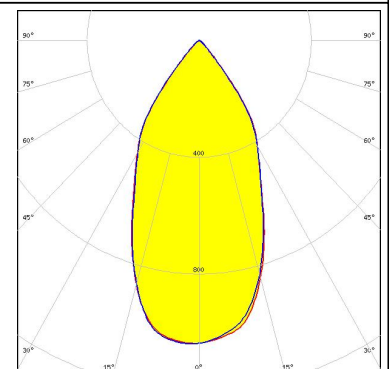
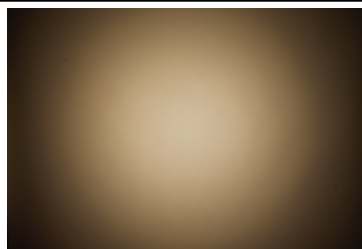

PHOTOMETRIC DATA (MEASURED):



LED CXA/B 1816 & CXA/B 1820 & CXA 1850
 FWHM 48.0°
 Efficiency 89 %
 Peak intensity 1.2 cd/lm
 LEDs/each optic 1
 Light colour White
 Required components:
 A.A.G. STUCCHI: 8403/G2

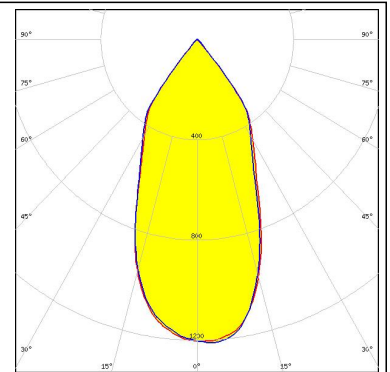
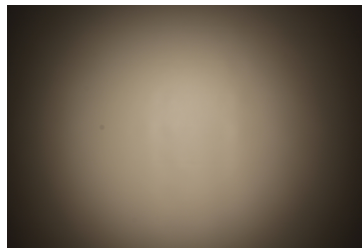

LED CXA/B 25xx
 FWHM 47.0°
 Efficiency 88 %
 Peak intensity 1.2 cd/lm
 LEDs/each optic 1
 Light colour White
 Required components:
 A.A.G. STUCCHI: 8401/G2

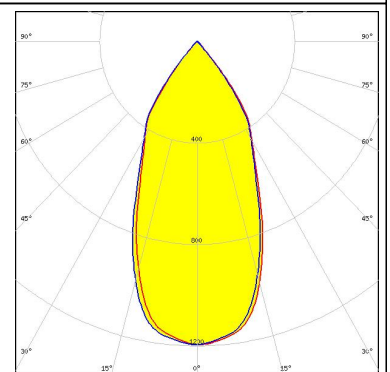
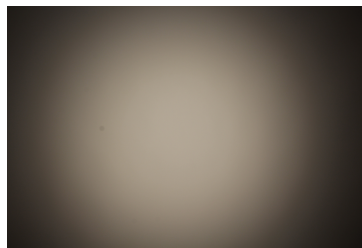

LED LUXEON CoB 1208
 FWHM 47.0°
 Efficiency 88 %
 Peak intensity 1.2 cd/lm
 LEDs/each optic 1
 Light colour White
 Required components:
 A.A.G. STUCCHI: 8301/G2

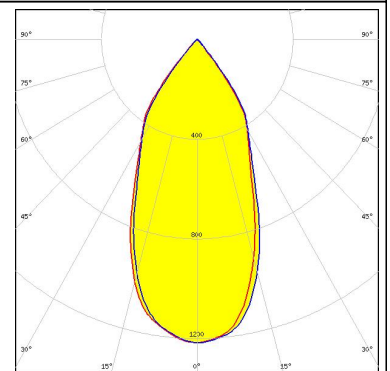
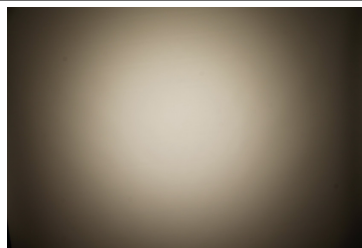

LED LUXEON CoB 1208
 FWHM 47.0°
 Efficiency 88 %
 Peak intensity 1.2 cd/lm
 LEDs/each optic 1
 Light colour White
 Required components:
 A.A.G. STUCCHI: 8301/G2

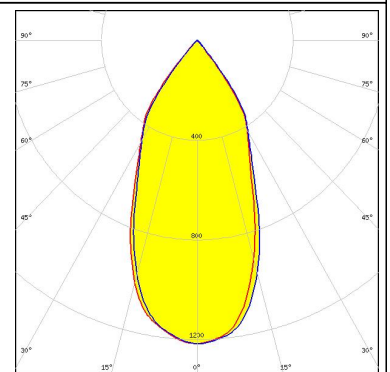
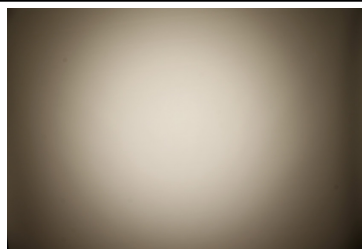

PHOTOMETRIC DATA (MEASURED):



LED LUXEON CoB 1208
FWHM 50.0°
Efficiency 84 %
Peak intensity 1.1 cd/lm
LEDs/each optic 1
Light colour White
Required components:
 F13671_ANGE-RZ-LENS
 A.A.G. STUCCHI: 8301/G2

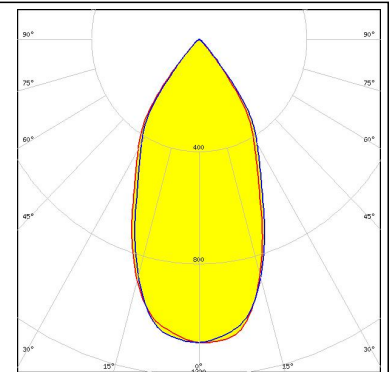
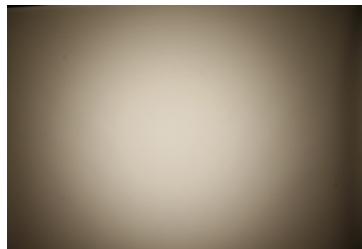

LED Fortimo SLM L19 CoB
FWHM 50.0°
Efficiency 85 %
Peak intensity 1.1 cd/lm
LEDs/each optic 1
Light colour White
Required components:
 F13671_ANGE-RZ-LENS
 BJB: 47.319.2030

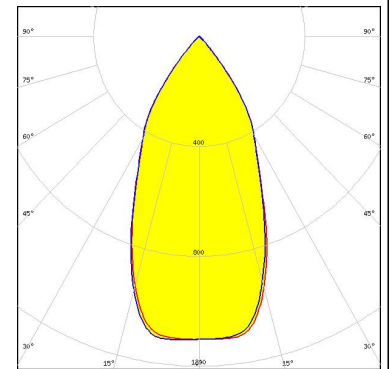
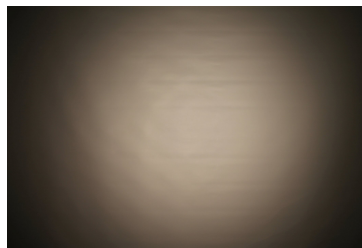

LED Fortimo SLM L19 CoB
FWHM 47.0°
Efficiency 90 %
Peak intensity 1.3 cd/lm
LEDs/each optic 1
Light colour White
Required components:
 BJB: 47.319.2030

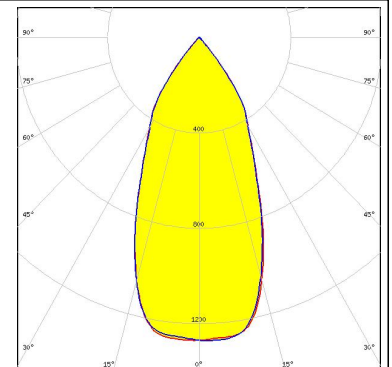
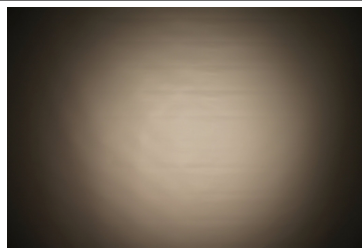

LED Fortimo SLM L23 CoB
FWHM 49.0°
Efficiency 89 %
Peak intensity 1.2 cd/lm
LEDs/each optic 1
Light colour White
Required components:
 BJB: 47.319.2030

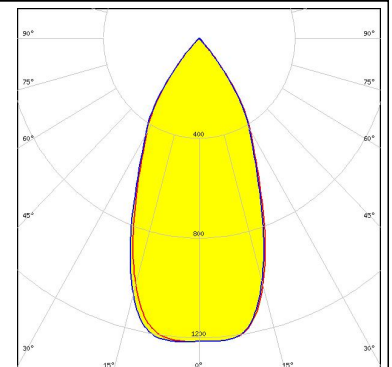
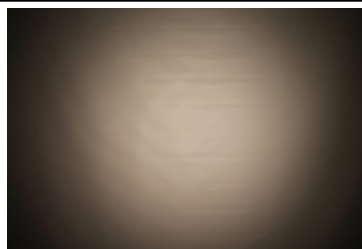

PHOTOMETRIC DATA (MEASURED):

PHILIPS

LED Fortimo SLM L23 CoB
 FWHM 51.0°
 Efficiency 85 %
 Peak intensity 1.1 cd/lm
 LEDs/each optic 1
 Light colour White
 Required components:
 F13671_ANGE-RZ-LENS
 BJB: 47.319.2030

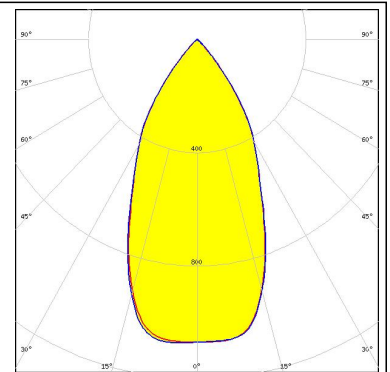
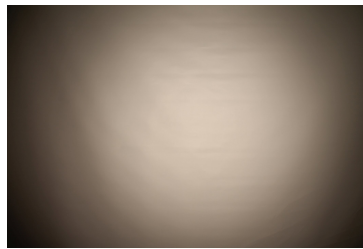

SAMSUNG

LED LC016D / LC019D / LC026D / LC033D
 FWHM 48.0°
 Efficiency 89 %
 Peak intensity 1.2 cd/lm
 LEDs/each optic 1
 Light colour White
 Required components:
 BJB: 47.319.2021

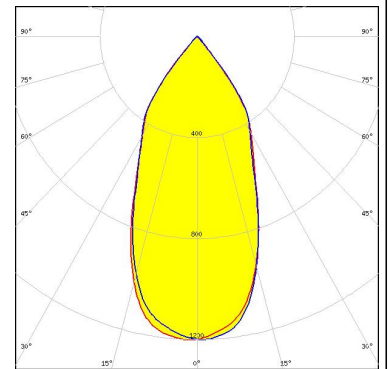
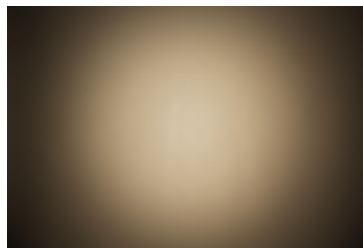

SAMSUNG

LED LC016D / LC019D / LC026D / LC033D
 FWHM 48.0°
 Efficiency 89 %
 Peak intensity 1.2 cd/lm
 LEDs/each optic 1
 Light colour White
 Required components:
 A.A.G. STUCCHI: 8101/G2

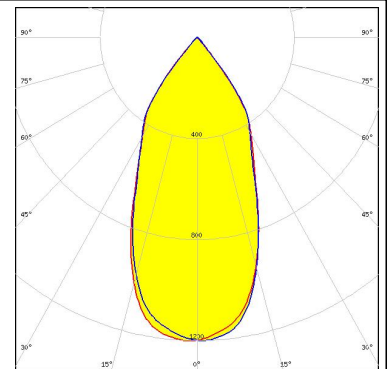
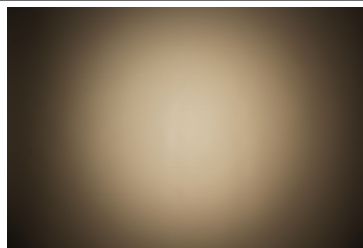

SAMSUNG

LED LC016D / LC019D / LC026D / LC033D
 FWHM 51.0°
 Efficiency 86 %
 Peak intensity 1.1 cd/lm
 LEDs/each optic 1
 Light colour White
 Required components:
 F13671_ANGE-RZ-LENS
 BJB: 47.319.2021

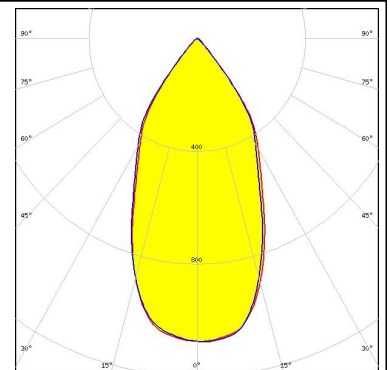
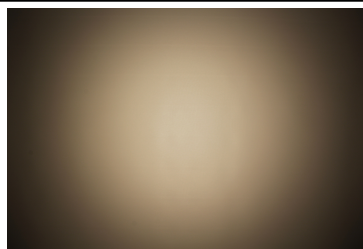

PHOTOMETRIC DATA (MEASURED):

SAMSUNG

LED LC016D / LC019D / LC026D / LC033D
 FWHM 51.0°
 Efficiency 86 %
 Peak intensity 1.1 cd/lm
 LEDs/each optic 1
 Light colour White
 Required components:
 F13671_ANGE-RZ-LENS
 A.A.G. STUCCHI: 8101/G2

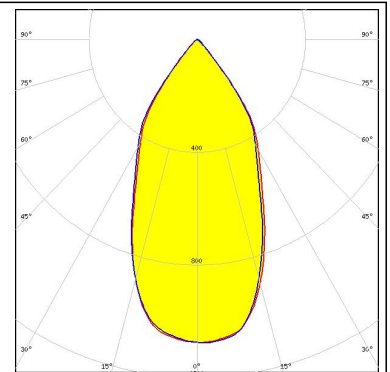
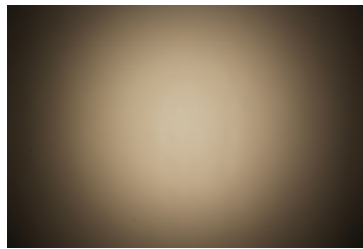

SAMSUNG

LED LC040C
 FWHM 50.0°
 Efficiency 87 %
 Peak intensity 1.2 cd/lm
 LEDs/each optic 1
 Light colour White
 Required components:
 BJB: 47.319.2030

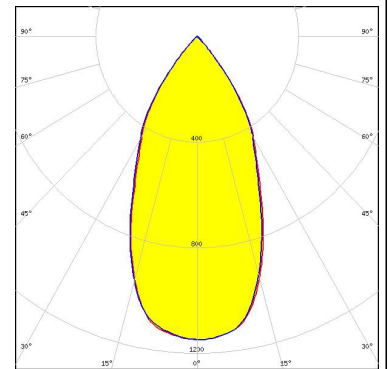
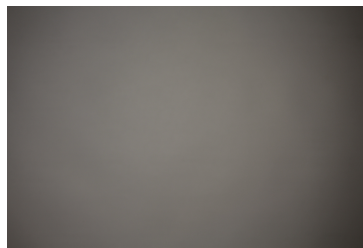

TRIDONIC

LED SLE G7 LES15
 FWHM 47.0°
 Efficiency 89 %
 Peak intensity 1.2 cd/lm
 LEDs/each optic 1
 Light colour White
 Required components:
 BJB: 47.319.2021

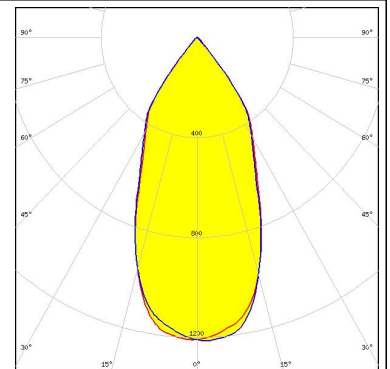
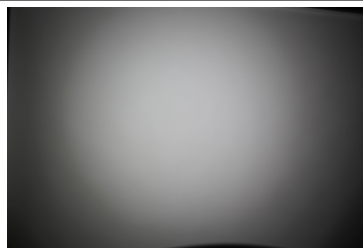

TRIDONIC

LED SLE G7 LES17 H
 FWHM 46.0°
 Efficiency 87 %
 Peak intensity 1.2 cd/lm
 LEDs/each optic 1
 Light colour White
 Required components:

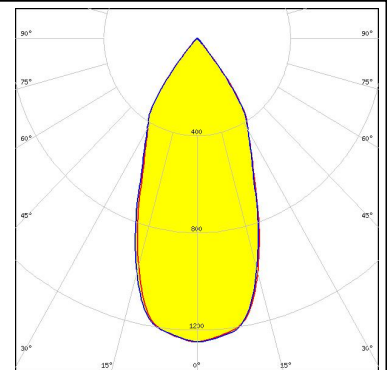
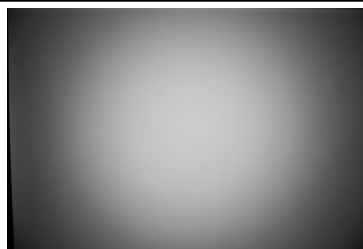

PHOTOMETRIC DATA (MEASURED):

TRIDONIC

LED SLE G7 LES21 H
FWHM 47.0°
Efficiency 87 %
Peak intensity 1.2 cd/lm
LEDs/each optic 1
Light colour White
Required components:

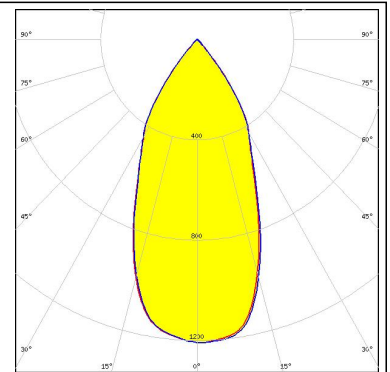
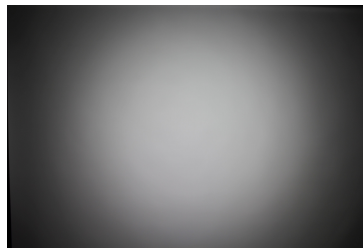

XICATO

LED XOB 14.5 mm
FWHM 48.0°
Efficiency 90 %
Peak intensity 1.2 cd/lm
LEDs/each optic 1
Light colour White
Required components:
BJB: 47.319.2021

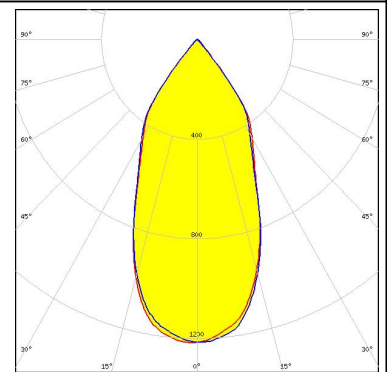
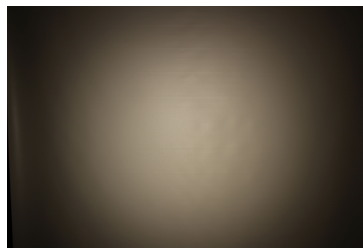

PHOTOMETRIC DATA (SIMULATED):

CITIZEN

LED CLL03x/CLU03x
FWHM 46.0°
Efficiency 89 %
Peak intensity 1.4 cd/lm
LEDs/each optic 1
Light colour White
Required components:
BJB: 47.319.2021

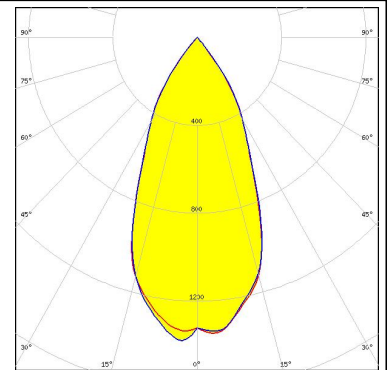

CITIZEN

LED CLL04x/CLU04x
FWHM 47.0°
Efficiency 88 %
Peak intensity 1.4 cd/lm
LEDs/each optic 1
Light colour White
Required components:
BJB: 47.319.2030

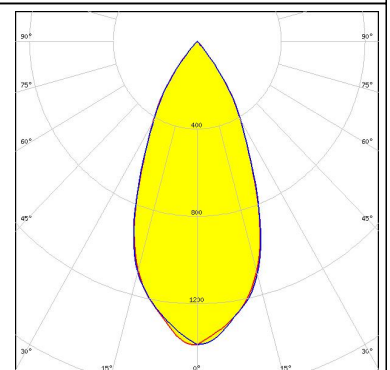

SAMSUNG

LED LC040D / LC060D / LC080D
FWHM 47.0°
Efficiency 87 %
Peak intensity 1.3 cd/lm
LEDs/each optic 1
Light colour White
Required components:
BJB: 47.319.2030

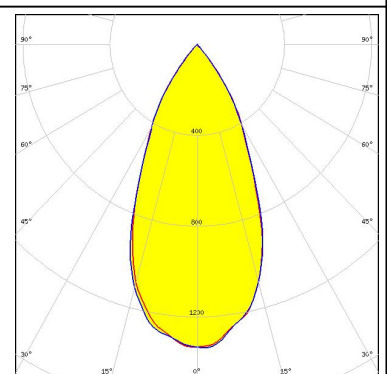

GENERAL INFORMATION:

NOTE: The typical beam angle will be changed by different color, chip size and chip position tolerance. The typical total beam angle is the full angle measured where the luminous intensity is half of the peak value.

Due to use of high power COB's with this product, special attention to proper thermal design is highly recommended. LEDiL has no liability for direct, indirect or consecutive damages arising from the LEDiL products being used outside of the recommended temperature range.

MATERIALS:

As part of our continuous research and improvement processes, and to ensure the best possible quality and availability of our products, LEDiL reserves the right to change material grades without notice.

PRODUCT DATA USER AGREEMENT AND DISCLAIMER:

The measured data in the provided downloadable LEDiL Product Datasheets and Mechanical 2D-Drawings is rounded and provided as reference for planning. LEDiL Oy's optical specifications have been verified by conducting performance testing of the products in accordance with the company's quality system. The reported data are averaged results of multiple measurements with typical variation. LEDiL Oy reserves the right to without prior notification make changes and improvements to its products.

LEDiL Oy assumes neither warranty, nor guarantee nor any other liability of any kind for the contents and correctness of the provided data. The provided data has been generated with highest diligence but the provided data may in reality not represent the complete possible variation range of all intrinsic parameters. Therefore, in certain cases a deviation from the provided data could occur.

LEDiL Oy reserves the right to undertake technical changes of its products without further notification which could lead to changes in the provided data. LEDiL Oy assumes no liability of any kind for the possible deviation from any provided data or any other damage resulting from the usage of the provided data.

The user agrees to this disclaimer and user agreement with the download or usage of the provided files.

LEDiL Oy

Joensuunkatu 13
FI-24240 SALO
Finland

LEDiL Inc.

228 West Page Street
Suite D
Sycamore IL 60178
USA

Local sales and technical support

www.ledil.com/where_to_buy

Shipping locations

Salo, Finland
Hong Kong, China

Distribution Partners

www.ledil.com/where_to_buy



Компания «ЭлектроПласт» предлагает заключение долгосрочных отношений при поставках импортных электронных компонентов на взаимовыгодных условиях!

Наши преимущества:

- Оперативные поставки широкого спектра электронных компонентов отечественного и импортного производства напрямую от производителей и с крупнейших мировых складов;
- Поставка более 17-ти миллионов наименований электронных компонентов;
- Поставка сложных, дефицитных, либо снятых с производства позиций;
- Оперативные сроки поставки под заказ (от 5 рабочих дней);
- Экспресс доставка в любую точку России;
- Техническая поддержка проекта, помощь в подборе аналогов, поставка прототипов;
- Система менеджмента качества сертифицирована по Международному стандарту ISO 9001;
- Лицензия ФСБ на осуществление работ с использованием сведений, составляющих государственную тайну;
- Поставка специализированных компонентов (Xilinx, Altera, Analog Devices, Intersil, Interpoint, Microsemi, Aeroflex, Peregrine, Syfer, Eurofarad, Texas Instrument, Miteq, Cobham, E2V, MA-COM, Hittite, Mini-Circuits, General Dynamics и др.);

Помимо этого, одним из направлений компании «ЭлектроПласт» является направление «Источники питания». Мы предлагаем Вам помощь Конструкторского отдела:

- Подбор оптимального решения, техническое обоснование при выборе компонента;
- Подбор аналогов;
- Консультации по применению компонента;
- Поставка образцов и прототипов;
- Техническая поддержка проекта;
- Защита от снятия компонента с производства.



Как с нами связаться

Телефон: 8 (812) 309 58 32 (многоканальный)

Факс: 8 (812) 320-02-42

Электронная почта: org@eplast1.ru

Адрес: 198099, г. Санкт-Петербург, ул. Калинина, дом 2, корпус 4, литера А.