

## FEATURES

- True 16-bit voltage output DAC,  $\pm 0.5$  LSB INL
- 8 nV/ $\sqrt{\text{Hz}}$  output noise spectral density
- 0.00625 LSB long-term linearity error stability
- $\pm 0.018$  ppm/ $^{\circ}\text{C}$  gain error temperature coefficient
- 2.5  $\mu\text{s}$  output voltage settling time
- 3.5 nV-sec midscale glitch impulse
- Integrated precision reference buffers
- Operating temperature range:  $-40^{\circ}\text{C}$  to  $+125^{\circ}\text{C}$
- 4 mm  $\times$  5 mm LFCSP package
- Wide power supply range of up to  $\pm 16.5$  V
- 35 MHz Schmitt triggered digital interface
- 1.8 V-compatible digital interface

## APPLICATIONS

- Medical instrumentation
- Test and measurement
- Industrial control
- Scientific and aerospace instrumentation
- Data acquisition systems
- Digital gain and offset adjustment
- Power supply control

## GENERAL DESCRIPTION

The AD5760<sup>1</sup> is a true 16-bit, unbuffered voltage output digital-to-analog converter (DAC) that operates from a bipolar supply of up to 33 V. The AD5760 accepts a positive reference input range of 5 V to  $V_{\text{DD}} - 2.5$  V and a negative reference input range of  $V_{\text{SS}} + 2.5$  V to 0 V. The AD5760 offers a relative accuracy specification of  $\pm 0.5$  LSB maximum range, and operation is guaranteed monotonic with a  $\pm 0.5$  LSB differential nonlinearity (DNL) maximum range specification.

The device uses a versatile 3-wire serial interface that operates at clock rates of up to 35 MHz and is compatible with standard serial peripheral interface (SPI), QSPI™, MICROWIRE™, and DSP interface standards. The device incorporates a power-on reset circuit that ensures that the DAC output powers up to 0 V in a known output impedance state and remains in this state until a valid write to the device takes place. The device provides an output clamp feature that places the output in a defined load state.

<sup>1</sup> Protected by U.S. Patent No. 7,884,747 and 8,089,380.

Rev. F

[Document Feedback](#)

Information furnished by Analog Devices is believed to be accurate and reliable. However, no responsibility is assumed by Analog Devices for its use, nor for any infringements of patents or other rights of third parties that may result from its use. Specifications subject to change without notice. No license is granted by implication or otherwise under any patent or patent rights of Analog Devices. Trademarks and registered trademarks are the property of their respective owners.

## FUNCTIONAL BLOCK DIAGRAM

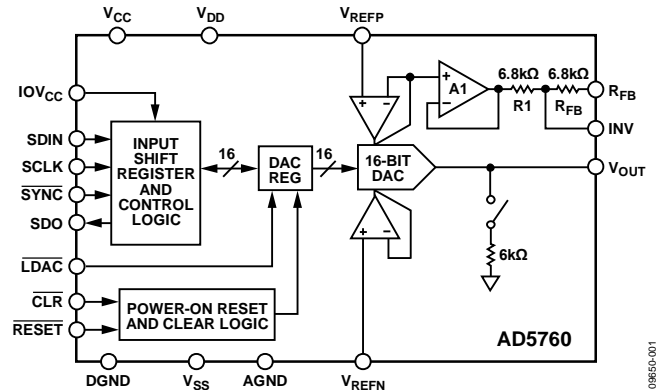

Figure 1.

Table 1. Related Devices

Part No.	Description
<a href="#">AD5790</a>	20-bit, 2 LSB accurate DAC
<a href="#">AD5791</a>	20-bit, 1 LSB accurate DAC
<a href="#">AD5780</a>	18-bit, 1 LSB accurate DAC
<a href="#">AD5781</a>	18-bit, 0.5 LSB INL
<a href="#">AD5541A/AD5542A</a>	16-bit, 1 LSB accurate 5 V DAC

## PRODUCT HIGHLIGHTS

1. True 16-bit accuracy.
2. Wide power supply range of up to  $\pm 16.5$  V.
3.  $-40^{\circ}\text{C}$  to  $+125^{\circ}\text{C}$  operating temperature range.
4. Low 8 nV/ $\sqrt{\text{Hz}}$  noise.
5. Low  $\pm 0.018$  ppm/ $^{\circ}\text{C}$  gain error temperature coefficient.

## COMPANION PRODUCTS

Output Amplifier Buffer: [AD8675](#), [ADA4898-1](#), [ADA4004-1](#)

External Reference: [ADR445](#)

DC-to-DC Design Tool: [ADIsimPower™](#)

Additional companion products on the [AD5780 product page](#).

## TABLE OF CONTENTS

Features .....	1	DAC Architecture.....	18
Applications.....	1	Serial Interface.....	18
Functional Block Diagram .....	1	Hardware Control Pins.....	19
General Description .....	1	On-Chip Registers.....	19
Product Highlights .....	1	AD5760 Features .....	23
Companion Products .....	1	Power-On to 0 V.....	23
Revision History .....	2	Power-Up Sequence .....	23
Specifications.....	3	Configuring the AD5760 .....	23
Timing Characteristics .....	5	DAC Output State .....	23
Absolute Maximum Ratings.....	7	Output Amplifier Configuration.....	23
ESD Caution.....	7	Applications Information .....	25
Pin Configuration and Function Descriptions.....	8	Typical Operating Circuit .....	25
Typical Performance Characteristics .....	9	Evaluation Board .....	26
Terminology .....	17	Outline Dimensions.....	27
Theory of Operation .....	18	Ordering Guide .....	27

## REVISION HISTORY

### 4/2018—Rev. E to Rev. F

Added Power-Up Sequence Section and Figure 50; Renumbered Sequentially .....	23
Updated Outline Dimensions .....	27
Changes to Ordering Guide .....	27

### 10/2016—Rev. D to Rev. E

Changes to Figure 4 and Table 5.....	8
Changes to Figure 42, Figure 43, and Figure 44 .....	15

### 7/2013—Rev. C to Rev. D

Changes to $t_1$ Test Conditions/Comments and Endnote 2 .....	5
Deleted Figure 4.....	7
Changes to Pin 11 Description .....	8
Deleted Daisy-Chain Operation Section.....	20

### 9/2012—Rev. B to Rev. C

Changes to Patent Footnote .....	1
Changes to Figure 46.....	17
Changes to Terminology Section .....	19
Changes to Figure 53.....	25
Changes to Figure 55.....	27
Updated Outline Dimensions and changes to Ordering Guide.....	29

### 2/2012—Rev. A to Rev. B

Deleted Linearity Compensation Section .....	3
--	---

### 12/2011—Rev. 0 to Rev. A

Changes to Table 2.....	3
Changes to Figure 48.....	18
Changes to DAC Register Section.....	22
Changes to Table 10 and Table 11 .....	23

### 11/2011—Revision 0: Initial Version

## SPECIFICATIONS

$V_{DD} = +12.5\text{ V to }+16.5\text{ V}$ ,  $V_{SS} = -16.5\text{ V to }-12.5\text{ V}$ ,  $V_{REFP} = +10\text{ V}$ ,  $V_{REFN} = -10\text{ V}$ ,  $V_{CC} = 2.7\text{ V to }5.5\text{ V}$ ,  $IOV_{CC} = 1.71\text{ V to }5.5\text{ V}$ ,  $s$   
 $R_L = \text{unloaded}$ ,  $C_L = \text{unloaded}$ ,  $T_{MIN}$  to  $T_{MAX}$ , unless otherwise noted.

Table 2.

Parameter	A, B Versions <sup>1</sup>			Unit	Test Conditions/Comments
	Min	Typ	Max		
STATIC PERFORMANCE <sup>2</sup>					
Resolution	16			Bits	
Integral Nonlinearity Error (Relative Accuracy)	-0.5		+0.5	LSB	B grade, $V_{REFX} = \pm 10\text{ V}$ , $+10\text{ V}$ and $+5\text{ V}$
Differential Nonlinearity Error	-2		+2	LSB	A grade, $V_{REFX} = \pm 10\text{ V}$ , $+10\text{ V}$ and $+5\text{ V}$
	-0.5		+0.5	LSB	B grade, $V_{REFX} = \pm 10\text{ V}$ , $+10\text{ V}$ and $+5\text{ V}$
Long-Term Linearity Error Stability <sup>3</sup>	-1		+1	LSB	A grade, $V_{REFX} = \pm 10\text{ V}$ , $+10\text{ V}$ and $+5\text{ V}$
		0.00625		LSB	After 750 hours at $T_A = 135^\circ\text{C}$
Full-Scale Error	-0.75	$\pm 0.2$	+0.75	LSB	$V_{REFP} = +10\text{ V}$ , $V_{REFN} = -10\text{ V}$
	-1.4	$\pm 0.17$	+1.4	LSB	$V_{REFP} = 10\text{ V}$ , $V_{REFN} = 0\text{ V}$
	-2.5	$\pm 0.1$	+2.5	LSB	$V_{REFP} = 5\text{ V}$ , $V_{REFN} = 0\text{ V}$
Full-Scale Error Temperature Coefficient		$\pm 0.026$		ppm/ $^\circ\text{C}$	$V_{REFP} = +10\text{ V}$ , $V_{REFN} = -10\text{ V}$
Zero-Scale Error	-1.2	$\pm 0.0812$	+1.2	LSB	$V_{REFP} = +10\text{ V}$ , $V_{REFN} = -10\text{ V}$
	-2.5	$\pm 0.044$	+2.5	LSB	$V_{REFP} = 10\text{ V}$ , $V_{REFN} = 0\text{ V}$
	-5.2	$\pm 0.056$	+5.2	LSB	$V_{REFP} = 5\text{ V}$ , $V_{REFN} = 0\text{ V}$
Zero-Scale Error Temperature Coefficient		$\pm 0.025$		ppm/ $^\circ\text{C}$	$V_{REFP} = +10\text{ V}$ , $V_{REFN} = -10\text{ V}$
Gain Error	-19	$\pm 2.3$	+19	ppm FSR	$V_{REFP} = +10\text{ V}$ , $V_{REFN} = -10\text{ V}$
	-35	$\pm 1.9$	+35	ppm FSR	$V_{REFP} = 10\text{ V}$ , $V_{REFN} = 0\text{ V}$
	-68	$\pm 0.9$	+68	ppm FSR	$V_{REFP} = 5\text{ V}$ , $V_{REFN} = 0\text{ V}$
Gain Error Temperature Coefficient		$\pm 0.018$		ppm/ $^\circ\text{C}$	$V_{REFP} = +10\text{ V}$ , $V_{REFN} = -10\text{ V}$
$R_1$ , $R_{FB}$ Matching		0.015		%	
OUTPUT CHARACTERISTICS					
Output Voltage Range	$V_{REFN}$		$V_{REFP}$	V	
Output Voltage Settling Time		2.5		$\mu\text{s}$	10 V step to 0.02%, using the <a href="#">ADA4898-1</a> buffer in unity-gain mode
Output Noise Spectral Density		3.5		$\mu\text{s}$	125 code step to $\pm 1\text{ LSB}^4$
		8		nV/ $\sqrt{\text{Hz}}$	At 1 kHz, DAC code = midscale
Output Voltage Noise		8		nV/ $\sqrt{\text{Hz}}$	At 10 kHz, DAC code = midscale
		1.1		$\mu\text{V p-p}$	DAC code = midscale, 0.1 Hz to 10 Hz bandwidth
Midscale Glitch Impulse <sup>4</sup>		14		nV-sec	$V_{REFP} = +10\text{ V}$ , $V_{REFN} = -10\text{ V}$
		3.5		nV-sec	$V_{REFP} = 10\text{ V}$ , $V_{REFN} = 0\text{ V}$
		4		nV-sec	$V_{REFP} = 5\text{ V}$ , $V_{REFN} = 0\text{ V}$
MSB Segment Glitch Impulse <sup>4</sup>		14		nV-sec	$V_{REFP} = +10\text{ V}$ , $V_{REFN} = -10\text{ V}$ , see Figure 42
		3.5		nV-sec	$V_{REFP} = 10\text{ V}$ , $V_{REFN} = 0\text{ V}$ , see Figure 43
		4		nV-sec	$V_{REFP} = 5\text{ V}$ , $V_{REFN} = 0\text{ V}$ , see Figure 44
Output Enabled Glitch Impulse		57		nV-sec	On removal of output ground clamp
Digital Feedthrough		0.27		nV-sec	
DC Output Impedance (Normal Mode)		3.4		k $\Omega$	
DC Output Impedance (Output Clamped to Ground)		6		k $\Omega$	

Parameter	A, B Versions <sup>1</sup>			Unit	Test Conditions/Comments
	Min	Typ	Max		
REFERENCE INPUTS					
$V_{REFP}$ Input Range	5		$V_{DD} - 2.5$	V	$T_A = 0^\circ\text{C}$ to $105^\circ\text{C}$ $V_{REFP}, V_{REFN}$
$V_{REFN}$ Input Range	$V_{SS} + 2.5$		0	V	
Input Bias Current	-20	-0.63	+20	nA	
Input Capacitance	-4	-0.63	+4	pF	
LOGIC INPUTS					
Input Current <sup>5</sup>	-1		+1	$\mu\text{A}$	$\text{IOV}_{CC} = 1.71\text{ V}$ to $5.5\text{ V}$ $\text{IOV}_{CC} = 1.71\text{ V}$ to $5.5\text{ V}$
Input Low Voltage, $V_{IL}$			$0.3 \times \text{IOV}_{CC}$	V	
Input High Voltage, $V_{IH}$	$0.7 \times \text{IOV}_{CC}$			V	
Pin Capacitance		5		pF	
LOGIC OUTPUT (SDO)					
Output Low Voltage, $V_{OL}$			0.4	V	$\text{IOV}_{CC} = 1.71\text{ V}$ to $5.5\text{ V}$ , sinking 1 mA $\text{IOV}_{CC} = 1.71\text{ V}$ to $5.5\text{ V}$ , sourcing 1 mA
Output High Voltage, $V_{OH}$	$\text{IOV}_{CC} - 0.5$			V	
High Impedance Leakage Current			$\pm 1$	$\mu\text{A}$	
High Impedance Output Capacitance		3		pF	
POWER REQUIREMENTS					
$V_{DD}$	7.5		$V_{SS} + 33$	V	All digital inputs at DGND or $\text{IOV}_{CC}$  $\text{IOV}_{CC} \leq V_{CC}$
$V_{SS}$	$V_{DD} - 33$		-2.5	V	
$V_{CC}$	2.7		5.5	V	
$\text{IOV}_{CC}$	1.71		5.5	V	
$I_{DD}$		10.3	14	mA	SDO disabled $\Delta V_{DD} \pm 10\%$ , $V_{SS} = -15\text{ V}$ $\Delta V_{SS} \pm 10\%$ , $V_{DD} = 15\text{ V}$ $\Delta V_{DD} \pm 200\text{ mV}$ , 50 Hz/60 Hz, $V_{SS} = -15\text{ V}$ $\Delta V_{SS} \pm 200\text{ mV}$ , 50 Hz/60 Hz, $V_{DD} = 15\text{ V}$
$I_{SS}$		-10	-14	mA	
$I_{CC}$		600	900	$\mu\text{A}$	
$\text{IOI}_{CC}$		52	140	$\mu\text{A}$	
DC Power Supply Rejection Ratio		$\pm 7.5$		$\mu\text{V/V}$	
		$\pm 1.5$		$\mu\text{V/V}$	
AC Power Supply Rejection Ratio		90		dB	
		90		dB	

<sup>1</sup> Temperature range:  $-40^\circ\text{C}$  to  $+125^\circ\text{C}$ , typical conditions:  $T_A = 25^\circ\text{C}$ ,  $V_{DD} = +15\text{ V}$ ,  $V_{SS} = -15\text{ V}$ ,  $V_{REFP} = +10\text{ V}$ ,  $V_{REFN} = -10\text{ V}$ .

<sup>2</sup> Performance characterized with the AD8675ARZ output buffer.

<sup>3</sup> Linearity error refers to both INL error and DNL error; either parameter can be expected to drift by the amount specified after the length of time specified.

<sup>4</sup> The AD5760 is configured in unity-gain mode with a low-pass RC filter on the output.  $R = 300\ \Omega$ ,  $C = 143\ \text{pF}$  (total capacitance seen by the output buffer, lead capacitance, and so forth).

<sup>5</sup> Current flowing in an individual logic pin.

**TIMING CHARACTERISTICS**

$V_{CC} = 2.7\text{ V to }5.5\text{ V}$ ; all specifications  $T_{MIN}$  to  $T_{MAX}$ , unless otherwise noted.

**Table 3.**

Parameter	Limit <sup>1</sup>		Unit	Test Conditions/Comments
	$IOV_{CC} = 1.71\text{ V to }3.3\text{ V}$	$IOV_{CC} = 3.3\text{ V to }5.5\text{ V}$		
$t_1^2$	40	28	ns min	SCLK cycle time
	92	60	ns min	SCLK cycle time (readback mode)
$t_2$	15	10	ns min	SCLK high time
$t_3$	9	5	ns min	SCLK low time
$t_4$	5	5	ns min	$\overline{SYNC}$ to SCLK falling edge setup time
$t_5$	2	2	ns min	SCLK falling edge to $\overline{SYNC}$ rising edge hold time
$t_6$	48	40	ns min	Minimum $\overline{SYNC}$ high time
$t_7$	8	6	ns min	$\overline{SYNC}$ rising edge to next SCLK falling edge ignore
$t_8$	9	7	ns min	Data setup time
$t_9$	12	7	ns min	Data hold time
$t_{10}$	13	10	ns min	$\overline{LDAC}$ falling edge to $\overline{SYNC}$ falling edge
$t_{11}$	20	16	ns min	$\overline{SYNC}$ rising edge to $\overline{LDAC}$ falling edge
$t_{12}$	14	11	ns min	$\overline{LDAC}$ pulse width low
$t_{13}$	130	130	ns typ	$\overline{LDAC}$ falling edge to output response time
$t_{14}$	130	130	ns typ	$\overline{SYNC}$ rising edge to output response time ( $\overline{LDAC}$ tied low)
$t_{15}$	50	50	ns min	$\overline{CLR}$ pulse width low
$t_{16}$	140	140	ns typ	$\overline{CLR}$ pulse activation time
$t_{17}$	0	0	ns min	$\overline{SYNC}$ falling edge to first SCLK rising edge
$t_{18}$	65	60	ns max	$\overline{SYNC}$ rising edge to SDO tristate ( $C_L = 50\text{ pF}$ )
$t_{19}$	62	45	ns max	SCLK rising edge to SDO valid ( $C_L = 50\text{ pF}$ )
$t_{20}$	0	0	ns min	$\overline{SYNC}$ rising edge to SCLK rising edge ignore
$t_{21}$	35	35	ns typ	$\overline{RESET}$ pulse width low
$t_{22}$	150	150	ns typ	$\overline{RESET}$ pulse activation time

<sup>1</sup> All input signals are specified with  $t_r = t_f = 1\text{ ns/V}$  (10% to 90% of  $IOV_{CC}$ ) and timed from a voltage level of  $(V_{IL} + V_{IH})/2$ .

<sup>2</sup> Maximum SCLK frequency is 35 MHz for write mode and 16 MHz for readback mode.

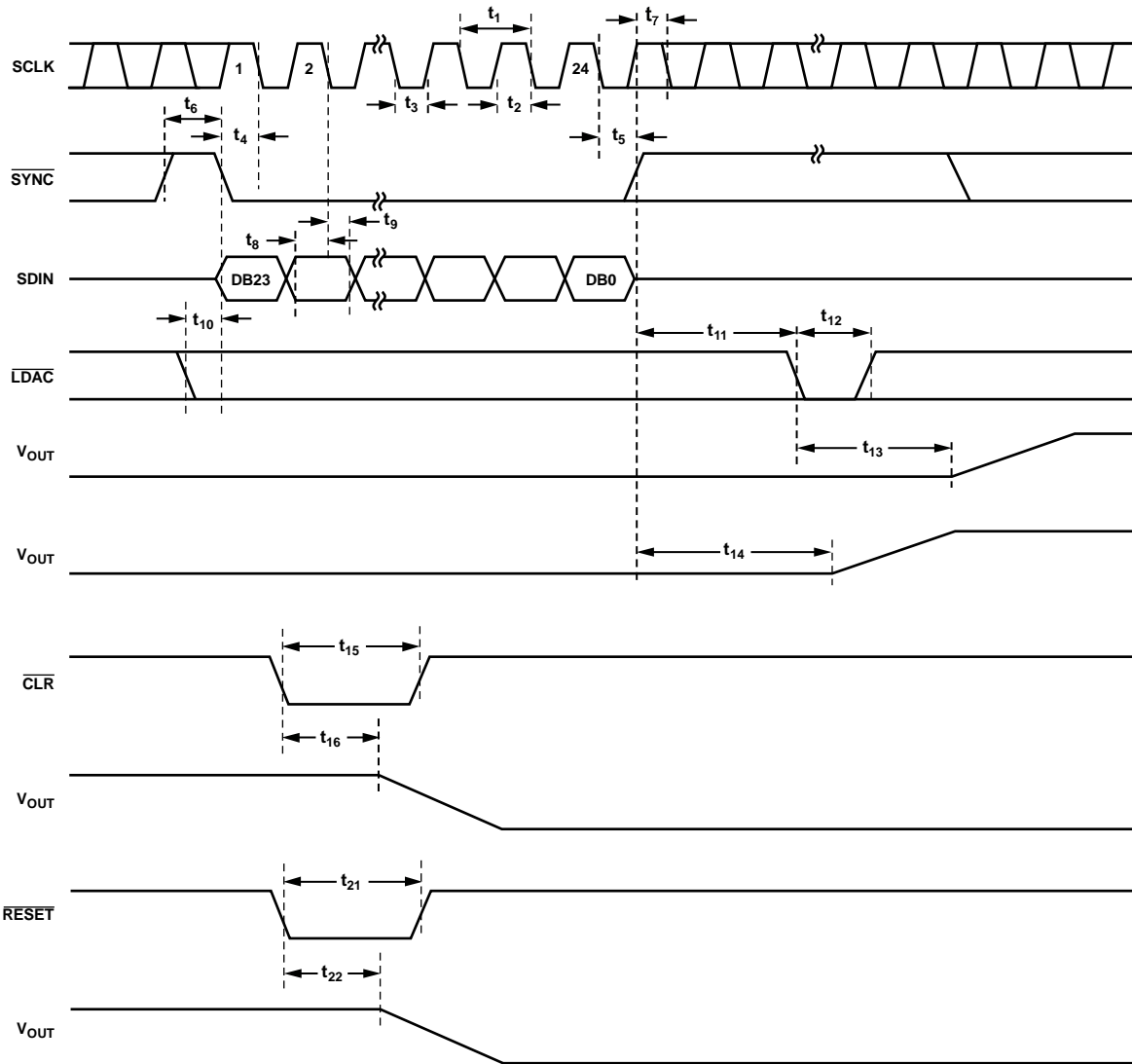

Figure 2. Write Mode Timing Diagram

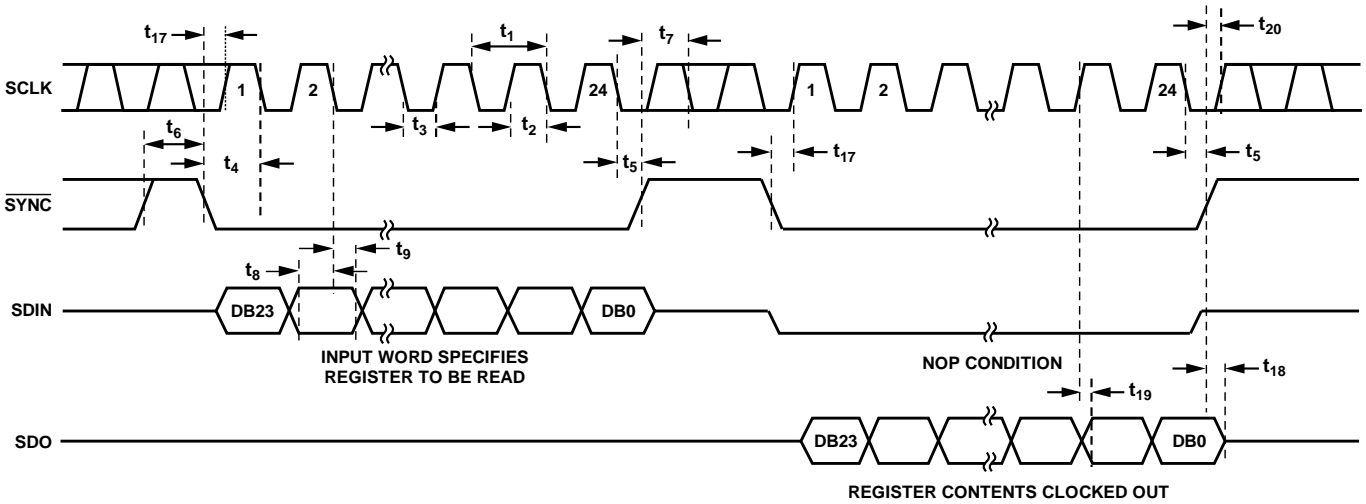

Figure 3. Readback Mode Timing Diagram

## ABSOLUTE MAXIMUM RATINGS

$T_A = 25^\circ\text{C}$ , unless otherwise noted. Transient currents of up to 100 mA do not cause SCR latch-up.

Table 4.

Parameter	Rating
$V_{DD}$ to AGND	-0.3 V to +34 V
$V_{SS}$ to AGND	-34 V to +0.3 V
$V_{DD}$ to $V_{SS}$	-0.3 V to +34 V
$V_{CC}$ to DGND	-0.3 V to +7 V
$IOV_{CC}$ to DGND	-0.3 V to $V_{CC} + 3\text{ V}$ or +7 V (whichever is less)
Digital Inputs to DGND	-0.3 V to $IOV_{CC} + 0.3\text{ V}$ or +7 V (whichever is less)
$V_{OUT}$ to AGND	-0.3 V to $V_{DD} + 0.3\text{ V}$
$V_{REFP}$ to AGND	-0.3 V to $V_{DD} + 0.3\text{ V}$
$V_{REFN}$ to AGND	$V_{SS} - 0.3\text{ V}$ to +0.3 V
DGND to AGND	-0.3 V to +0.3 V
Operating Temperature Range, $T_A$ Industrial	-40°C to +125°C
Storage Temperature Range	-65°C to +150°C
Maximum Junction Temperature, $T_J$ max	150°C
Power Dissipation	$(T_J \text{ max} - T_A)/\theta_{JA}$
LFCSP Package	
$\theta_{JA}$ Thermal Impedance	31.0°C/W
Lead Temperature	JEDEC industry standard
Soldering	J-STD-020
ESD (Human Body Model)	1.6 kV

Stresses at or above those listed under Absolute Maximum Ratings may cause permanent damage to the product. This is a stress rating only; functional operation of the product at these or any other conditions above those indicated in the operational section of this specification is not implied. Operation beyond the maximum operating conditions for extended periods may affect product reliability.

This device is a high performance integrated circuit with an ESD rating of 1.6 kV, and it is ESD sensitive. Proper precautions must be taken for handling and assembly.

### ESD CAUTION



**ESD (electrostatic discharge) sensitive device.** Charged devices and circuit boards can discharge without detection. Although this product features patented or proprietary protection circuitry, damage may occur on devices subjected to high energy ESD. Therefore, proper ESD precautions should be taken to avoid performance degradation or loss of functionality.

## PIN CONFIGURATION AND FUNCTION DESCRIPTIONS

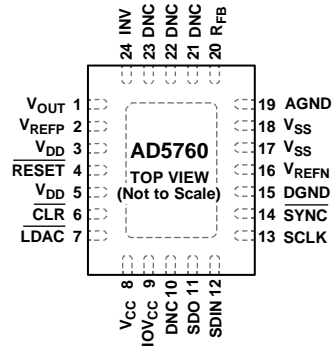

## NOTES

1. DNC = DO NOT CONNECT. DO NOT CONNECT TO THIS PIN.
2. NEGATIVE ANALOG SUPPLY CONNECTION ( $V_{SS}$ ). A VOLTAGE IN THE RANGE OF  $-16.5\text{V}$  TO  $-2.5\text{V}$  CAN BE CONNECTED TO THIS PIN.  $V_{SS}$  MUST BE DECOUPLED TO AGND.
3. EXPOSED PAD. THE EXPOSED PAD CAN BE LEFT ELECTRICALLY UNCONNECTED PROVIDED THAT A SUPPLY CONNECTION IS MADE AT THE  $V_{SS}$  PINS. IT IS RECOMMENDED THAT THE EXPOSED PAD BE THERMALLY CONNECTED TO A COPPER PLANE FOR ENHANCED THERMAL PERFORMANCE.

09650-005

Figure 4. Pin Configuration

Table 5. Pin Function Descriptions

Pin No.	Mnemonic	Description
1	$V_{OUT}$	Analog Output Voltage.
2	$V_{REFP}$	Positive Reference Voltage Input. A voltage in the range of 5 V to $V_{DD} - 2.5\text{V}$ can be connected to this pin.
3, 5	$V_{DD}$	Positive Analog Supply Connection. A voltage in the range of 7.5 V to 16.5 V can be connected to this pin. $V_{DD}$ must be decoupled to AGND.
4	$\overline{\text{RESET}}$	Active Low Reset. Asserting this pin returns the AD5760 to its power-on status.
6	$\overline{\text{CLR}}$	Active Low Input. Asserting this pin sets the DAC register to a user defined value (see Table 12) and updates the DAC output. The output value depends on the DAC register coding that is being used, either binary or twos complement.
7	$\overline{\text{LDAC}}$	Active Low Load DAC Logic Input. This pin is used to update the DAC register and, consequently, the analog output. When tied permanently low, the output is updated on the rising edge of $\overline{\text{SYNC}}$ . If $\overline{\text{LDAC}}$ is held high during the write cycle, the input register is updated, but the output update is held off until the falling edge of $\overline{\text{LDAC}}$ . Do not leave the $\overline{\text{LDAC}}$ pin unconnected.
8	$V_{CC}$	Digital Supply. Voltage range is from 2.7 V to 5.5 V. $V_{CC}$ should be decoupled to DGND.
9	$\text{IOV}_{CC}$	Digital Interface Supply. Digital threshold levels are referenced to the voltage applied to this pin. Voltage range is from 1.71 V to 5.5 V.
10, 21, 22, 23	DNC	Do Not Connect. Do not connect to these pins.
11	SDO	Serial Data Output. Data is clocked out on the rising edge of the serial clock input.
12	SDIN	Serial Data Input. This device has a 24-bit input shift register. Data is clocked into the register on the falling edge of the serial clock input.
13	SCLK	Serial Clock Input. Data is clocked into the input shift register on the falling edge of the serial clock input. Data can be transferred at rates of up to 35 MHz.
14	$\overline{\text{SYNC}}$	Level Triggered Control Input (Active Low). This is the frame synchronization signal for the input data. When $\overline{\text{SYNC}}$ goes low, it enables the input shift register, and data is then transferred in on the falling edges of the following clocks. The DAC is updated on the rising edge of $\overline{\text{SYNC}}$ .
15	DGND	Ground Reference Pin for Digital Circuitry.
16	$V_{REFN}$	Negative Reference Voltage Input.
17, 18	$V_{SS}$	Negative Analog Supply Connection. A voltage in the range of $-16.5\text{V}$ to $-2.5\text{V}$ can be connected to this pin. $V_{SS}$ must be decoupled to AGND.
19	AGND	Ground Reference Pin for Analog Circuitry.
20	$R_{FB}$	Feedback Connection for External Amplifier. See the AD5760 Features section for further details.
24	INV	Inverting Input Connection for External Amplifier. See the AD5760 Features section for further details.
	EPAD ( $V_{SS}$ )	Exposed Pad. The exposed pad can be left electrically unconnected provided that a supply connection is made at the $V_{SS}$ pins. It is recommended that the exposed pad be thermally connected to a copper plane for enhanced thermal performance.



# TYPICAL PERFORMANCE CHARACTERISTICS

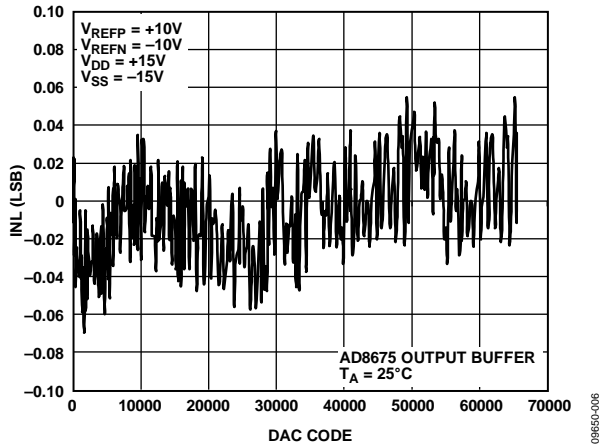

Figure 5. Integral Nonlinearity Error vs. DAC Code, ±10 V Span

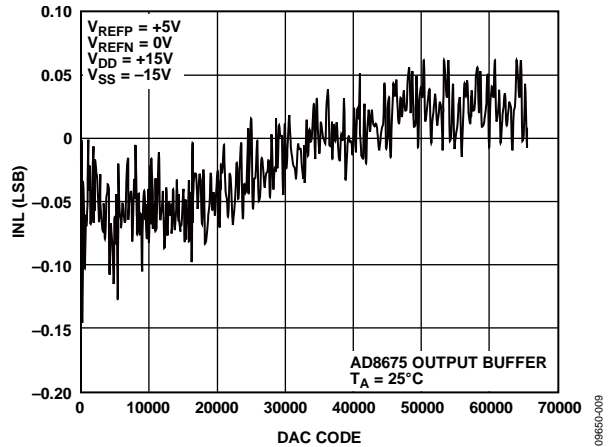

Figure 8. Integral Nonlinearity Error vs. DAC Code, 5 V Span, ×2 Gain Mode

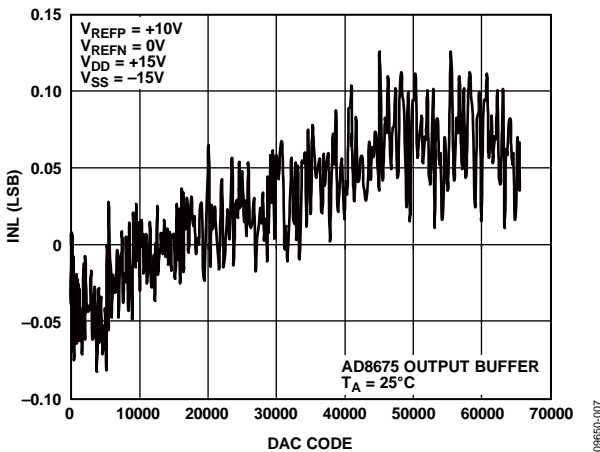

Figure 6. Integral Nonlinearity Error vs. DAC Code, 10 V Span

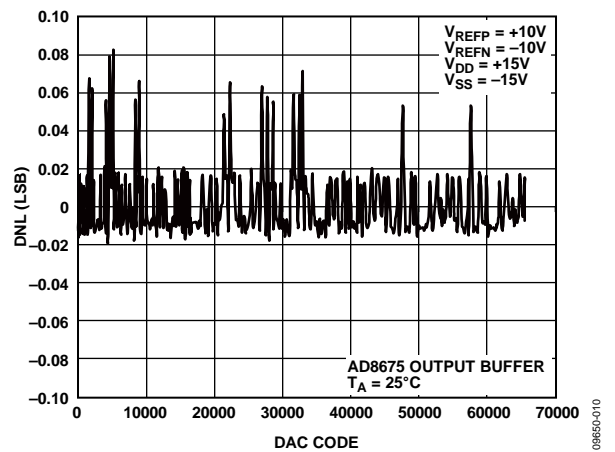

Figure 9. Differential Nonlinearity Error vs. DAC Code, ±10 V Span

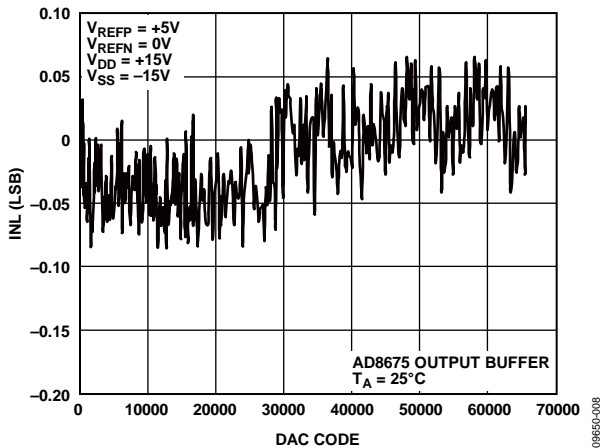

Figure 7. Integral Nonlinearity Error vs. DAC Code, 5 V Span

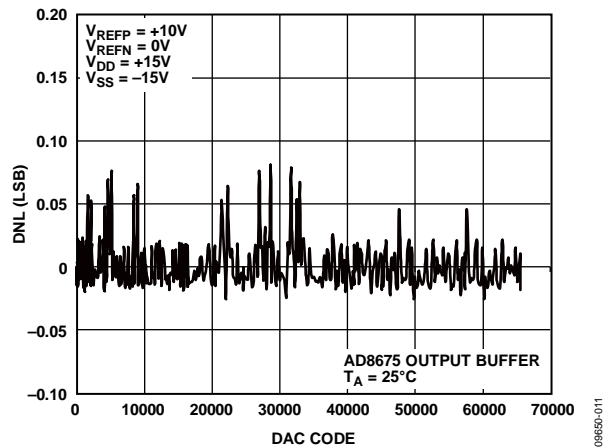

Figure 10. Differential Nonlinearity Error vs. DAC Code, 10 V Span

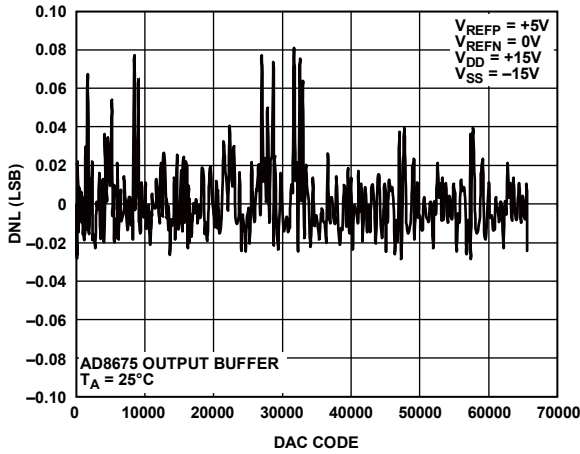

Figure 11. Differential Nonlinearity Error vs. DAC Code, 5 V Span

09850-012

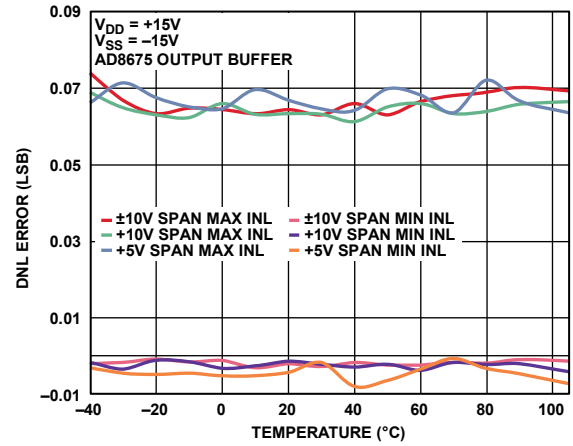

Figure 14. Differential Nonlinearity Error vs. Temperature

09850-014

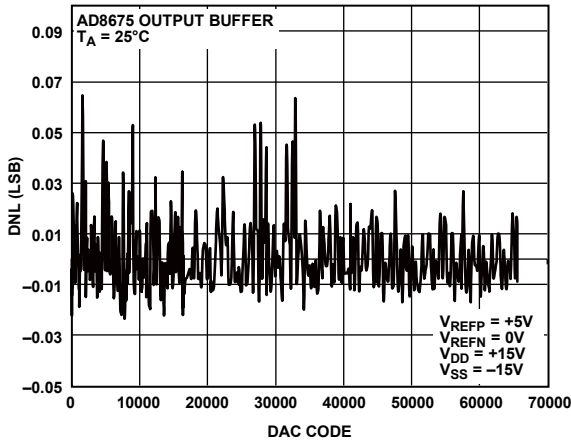

Figure 12. Differential Nonlinearity Error vs. DAC Code, 5 V Span, x2 Gain Mode

09850-013

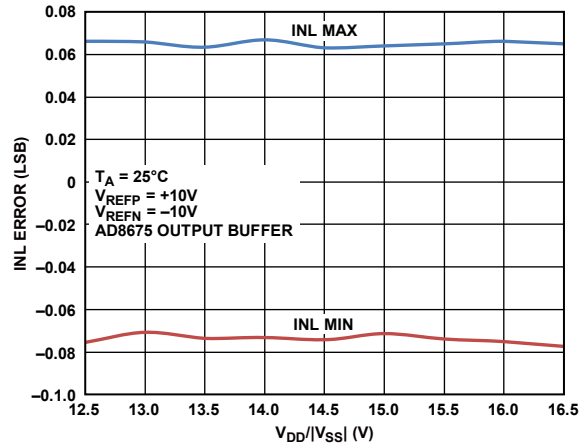

Figure 15. Integral Nonlinearity Error vs. Supply Voltage, ±10 V Span

09850-016

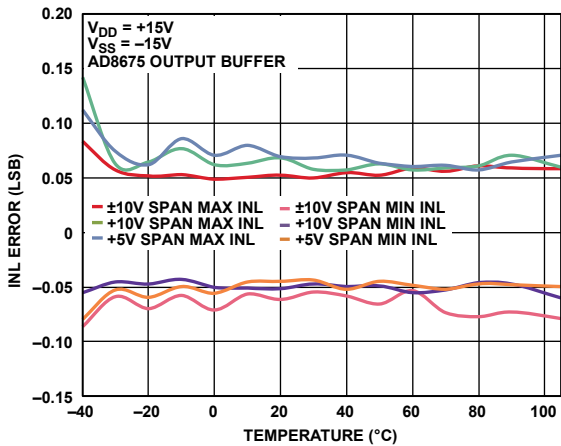

Figure 13. Integral Nonlinearity Error vs. Temperature

09850-015

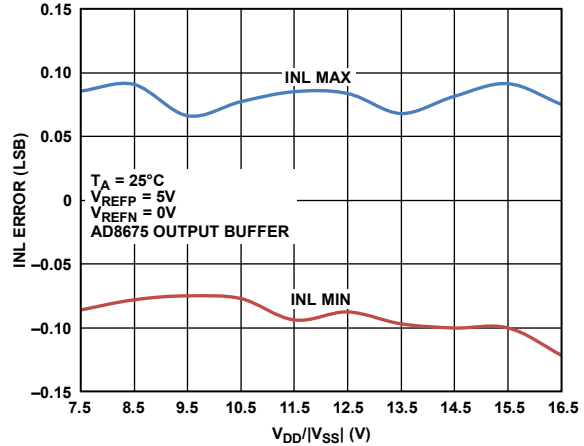

Figure 16. Integral Nonlinearity Error vs. Supply Voltage, 5 V Span

09850-017

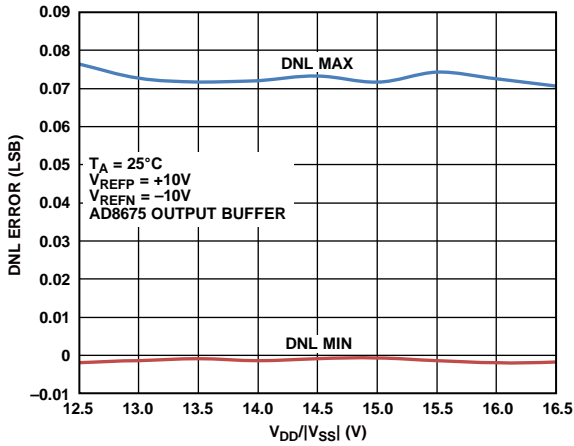

Figure 17. Differential Nonlinearity Error vs. Supply Voltage, ±10 V Span

09850-018

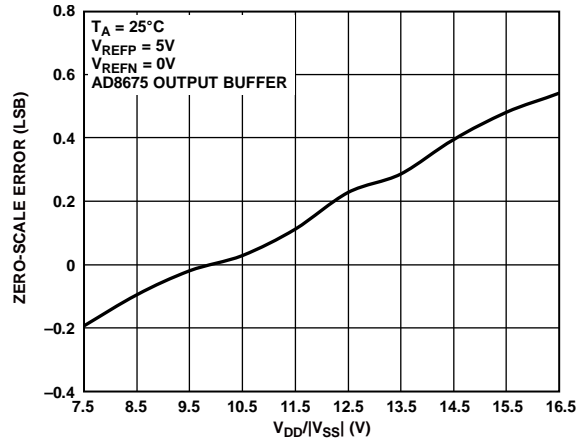

Figure 20. Zero-Scale Error vs. Supply Voltage, 5 V Span

09850-021

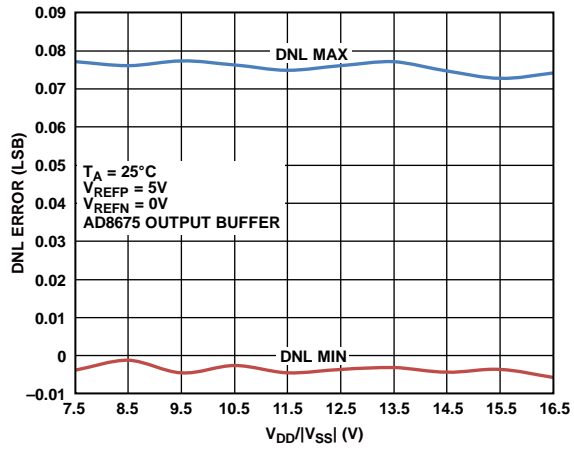

Figure 18. Differential Nonlinearity Error vs. Supply Voltage, 5 V Span

09850-019

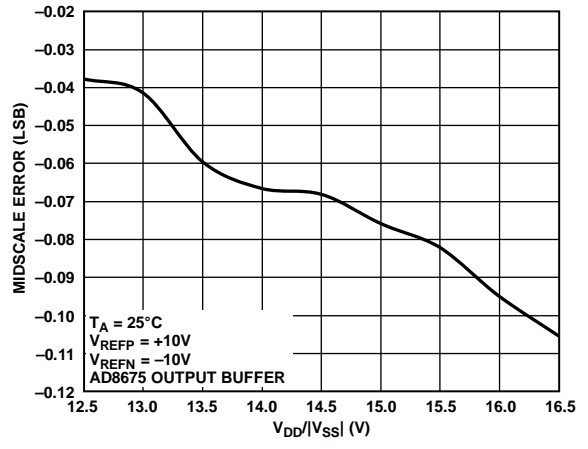

Figure 21. Midscale Error vs. Supply Voltage, ±10 V Span

09850-022

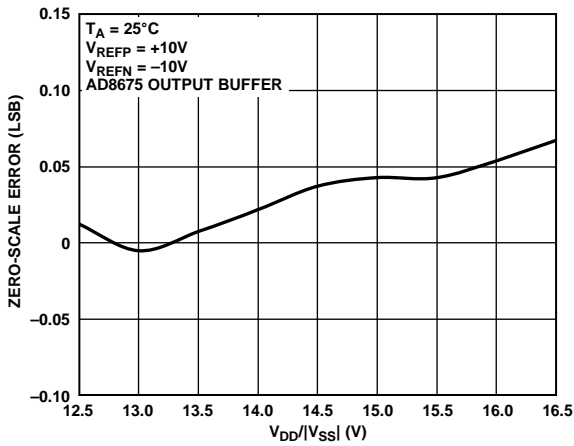

Figure 19. Zero-Scale Error vs. Supply Voltage, ±10 V Span

09850-020

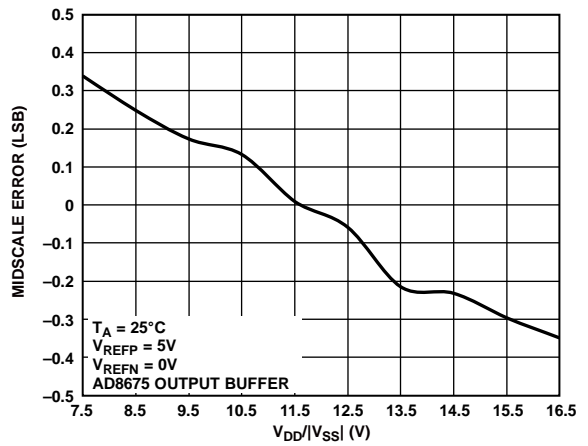

Figure 22. Midscale Error vs. Supply Voltage, 5 V Span

09850-023

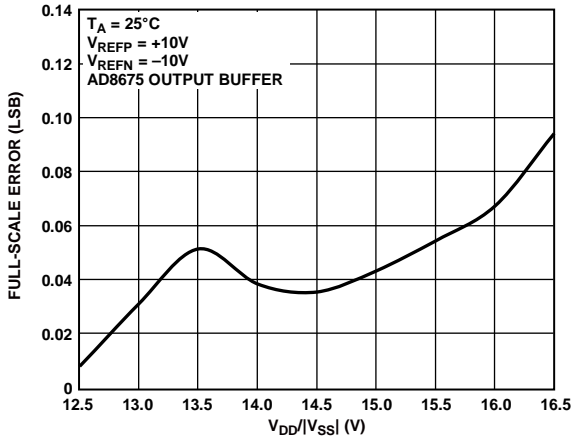

Figure 23. Full-Scale Error vs. Supply Voltage, ±10 V Span

09850-024

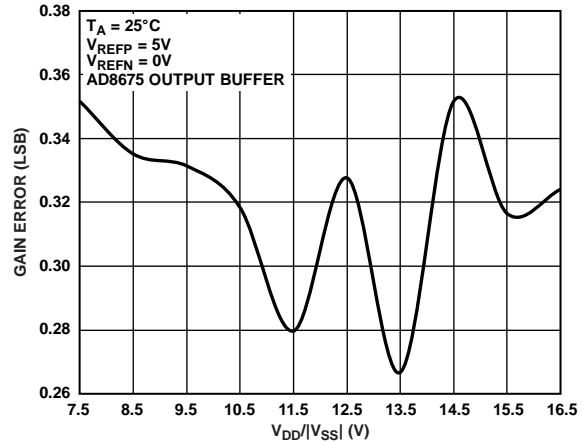

Figure 26. Gain Error vs. Supply Voltage, 5 V Span

09850-027

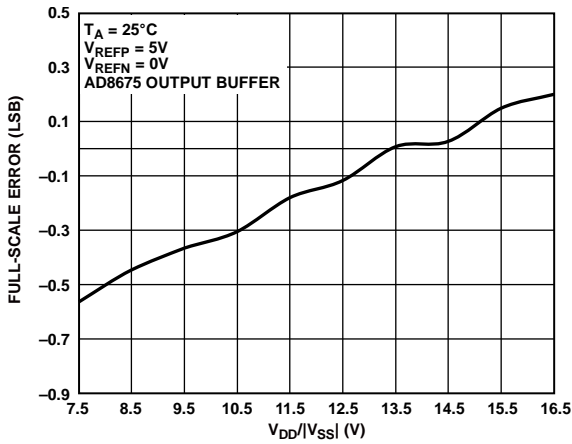

Figure 24. Full-Scale Error vs. Supply Voltage, 5 V Span

09850-025

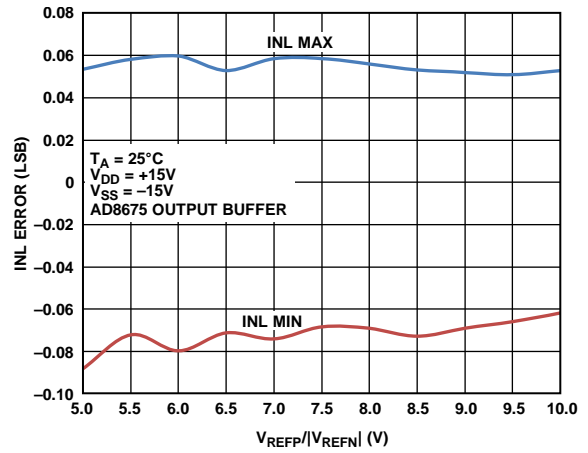

Figure 27. Integral Nonlinearity Error vs. Reference Voltage

09850-028

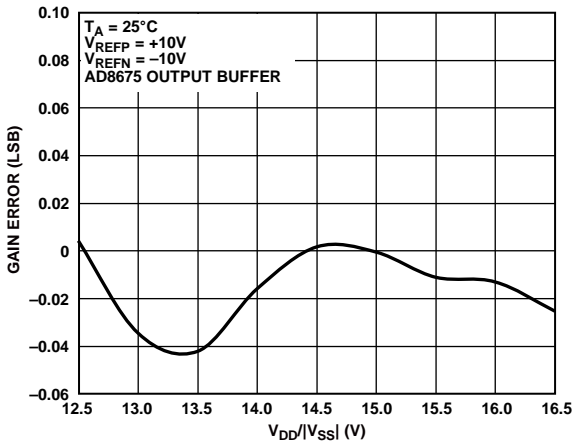

Figure 25. Gain Error vs. Supply Voltage, ±10 V Span

09850-026

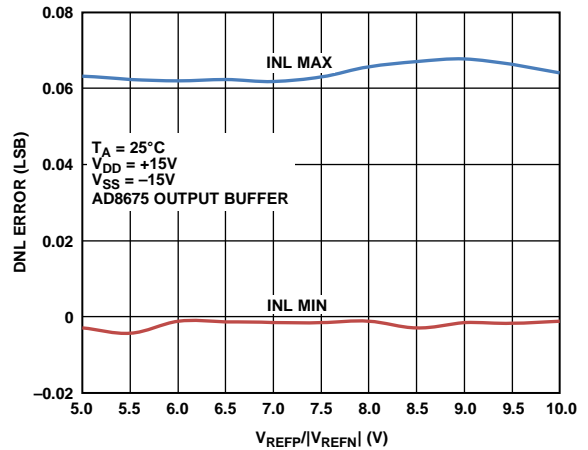

Figure 28. Differential Nonlinearity Error vs. Reference Voltage

09850-029

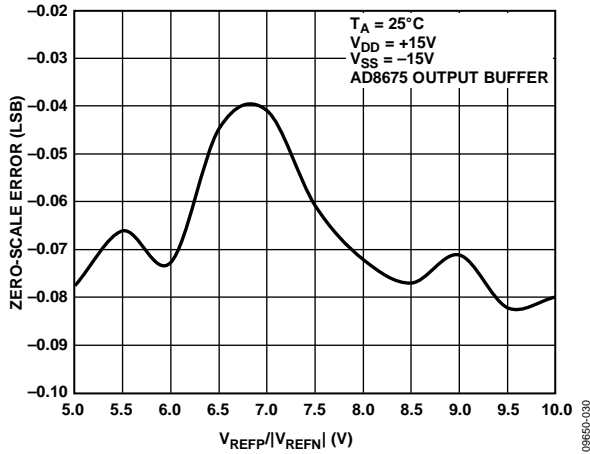

Figure 29. Zero-Scale Error vs. Reference Voltage

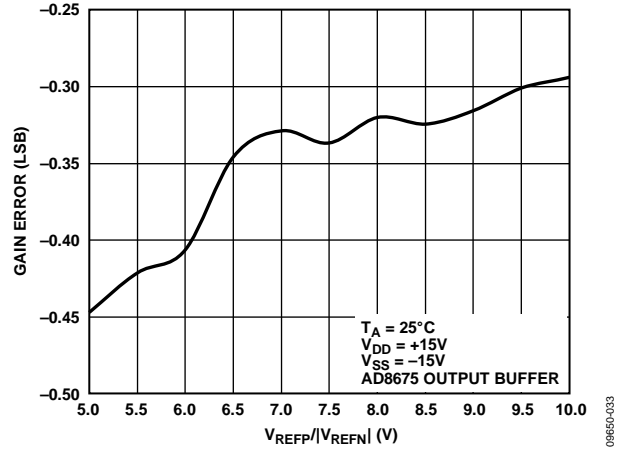

Figure 32. Gain Error vs. Reference Voltage

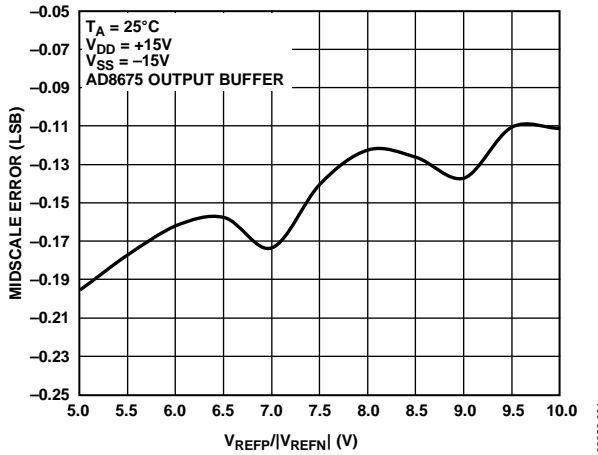

Figure 30. Midscale Error vs. Reference Voltage

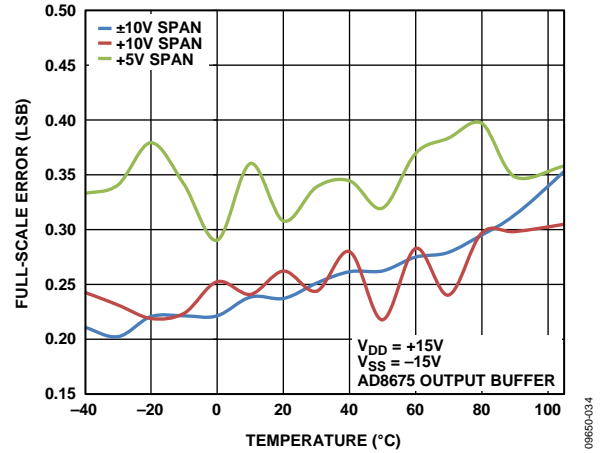

Figure 33. Full-Scale Error vs. Temperature

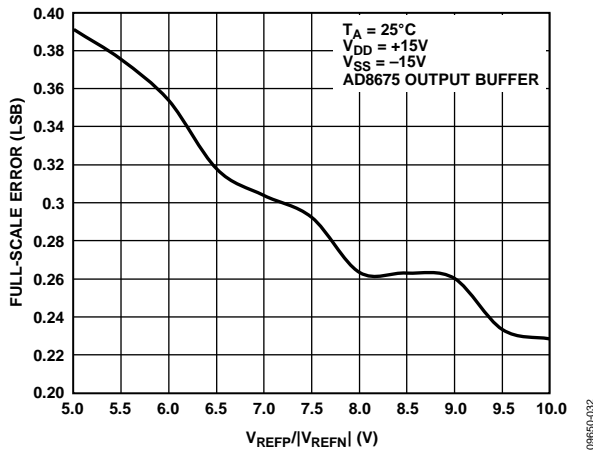

Figure 31. Full-Scale Error vs. Reference Voltage

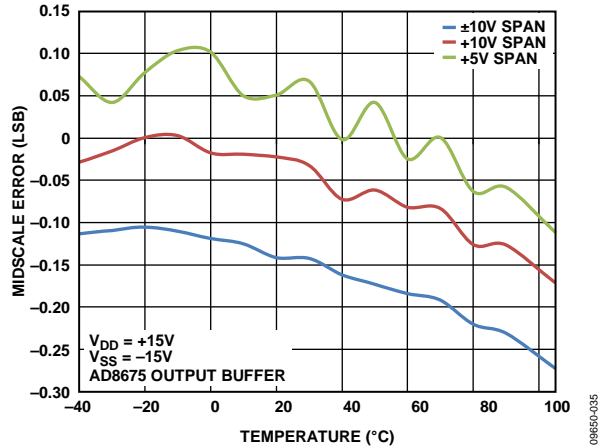

Figure 34. Midscale Error vs. Temperature

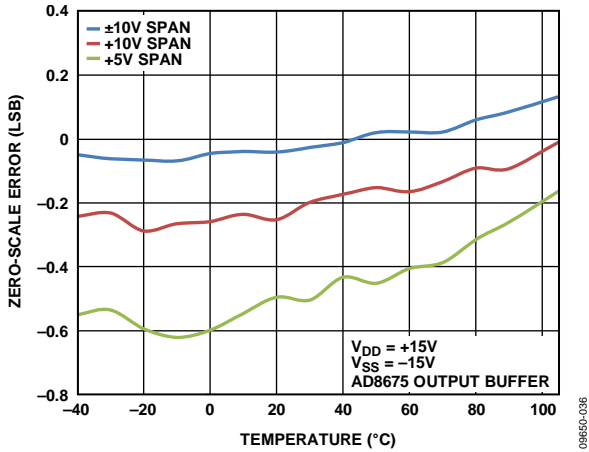

Figure 35. Zero-Scale Error vs. Temperature

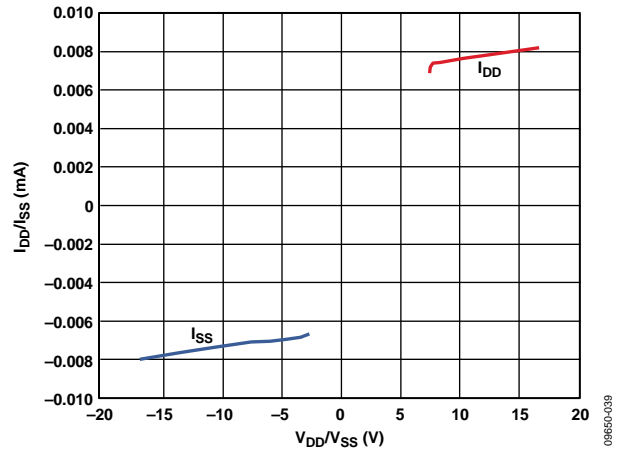

Figure 38. Power Supply Currents vs. Power Supply Voltages

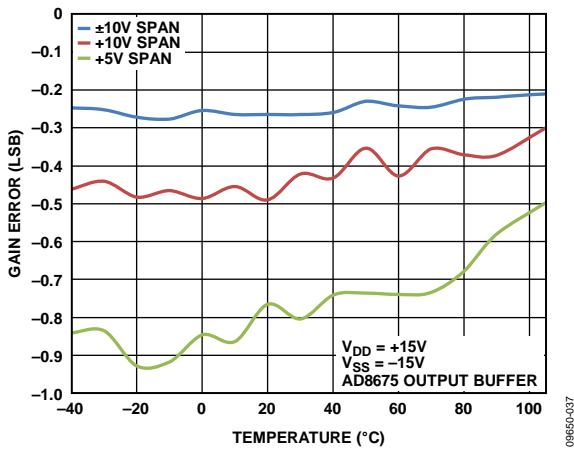

Figure 36. Gain Error vs. Temperature

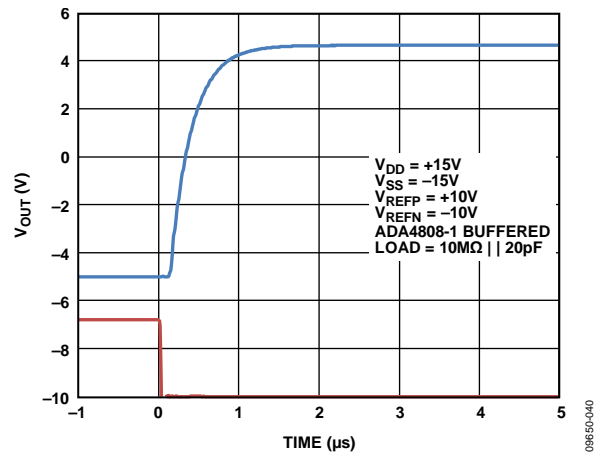

Figure 39. Rising Full-Scale Voltage Step

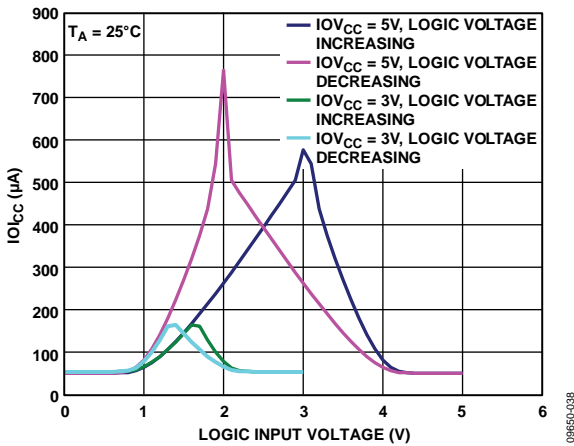

Figure 37.  $IOI_{CC}$  vs. Logic Input Voltage

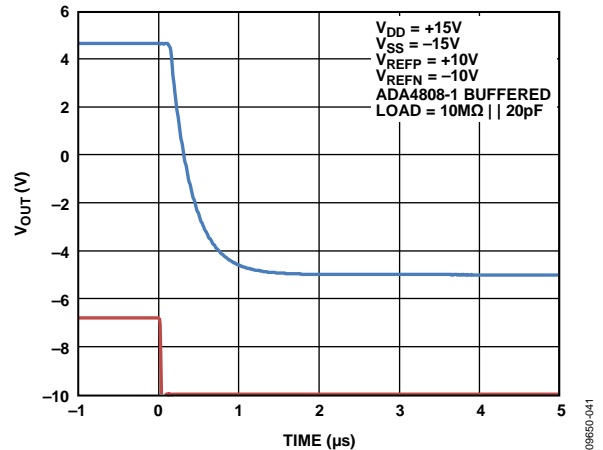

Figure 40. Falling Full-Scale Voltage Step

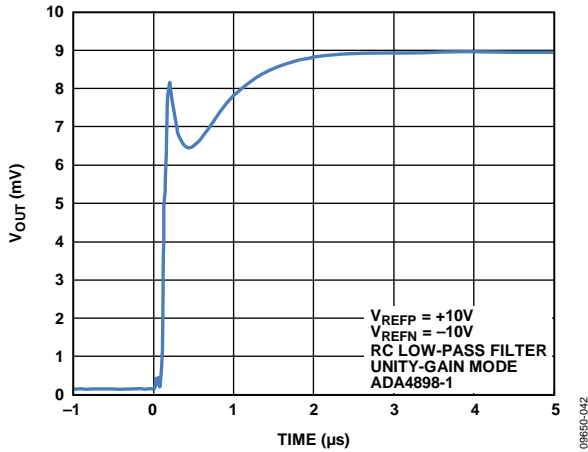

Figure 41. 500 Code Step Settling Time

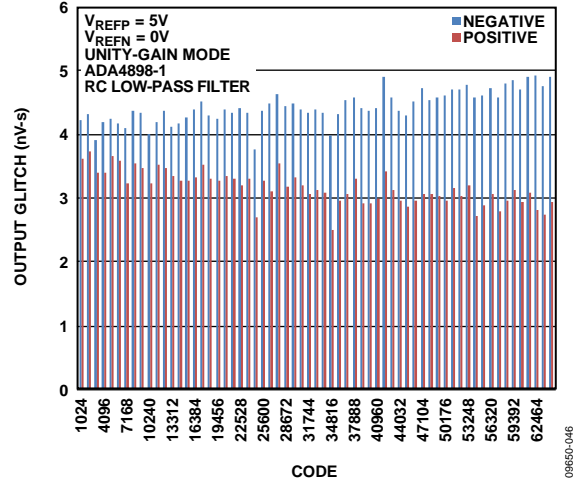

Figure 44. 6 MSB Segment Glitch Energy for 5 V  $V_{REF}$

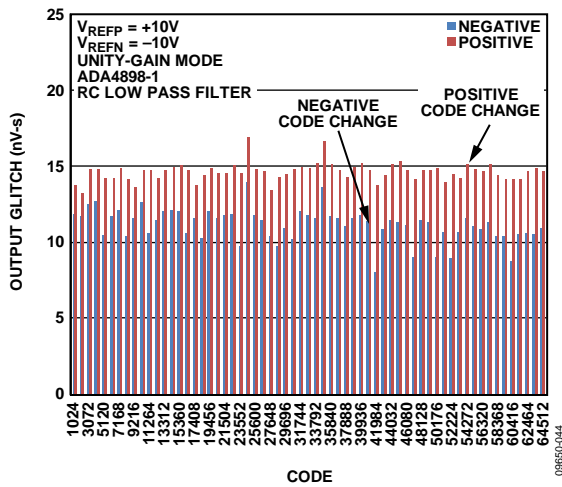

Figure 42. 6 MSB Segment Glitch Energy for  $\pm 10$  V  $V_{REF}$

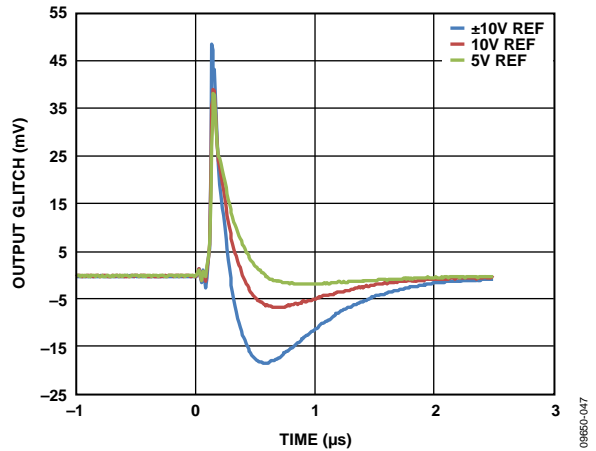

Figure 45. Midscale Peak-to-Peak Glitch for  $\pm 10$  V

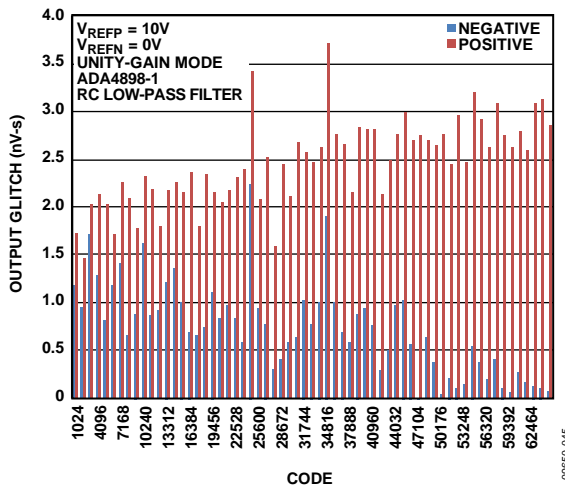

Figure 43. 6 MSB Segment Glitch Energy for 10 V  $V_{RE}$

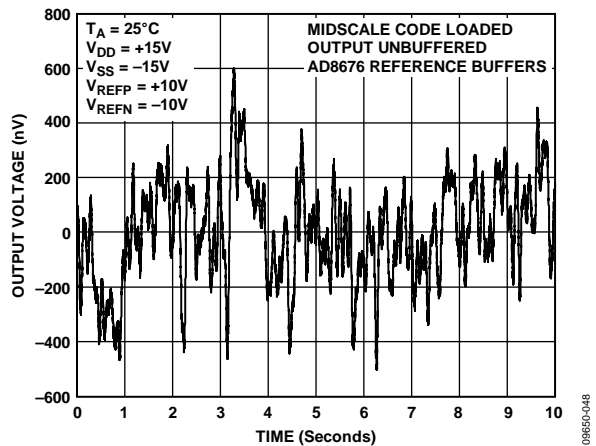

Figure 46. Voltage Output Noise, 0.1 Hz to 10 Hz Bandwidth

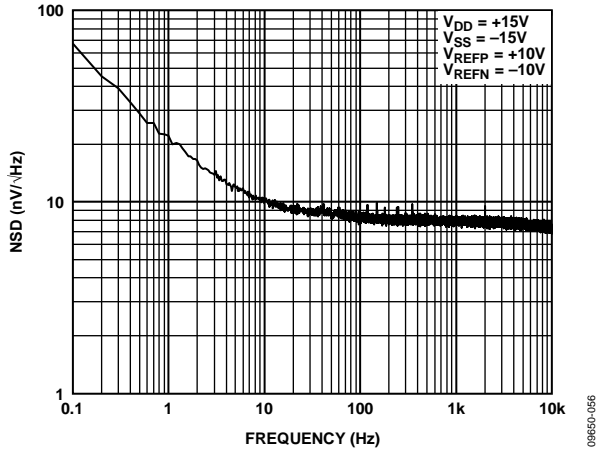

Figure 47. Noise Spectral Density vs. Frequency

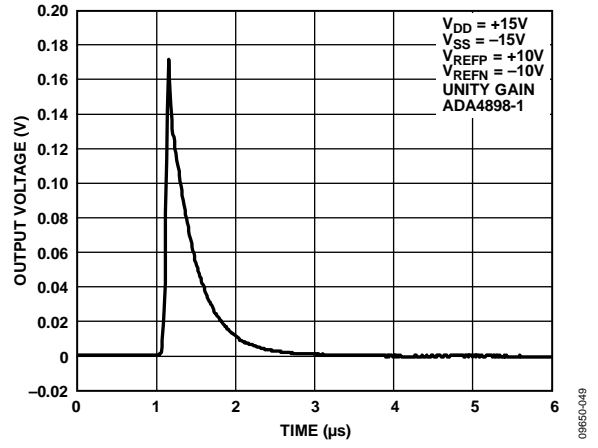

Figure 48. Glitch Impulse on Removal of Output Clamp



## TERMINOLOGY

### Relative Accuracy

Relative accuracy, or integral nonlinearity (INL), is a measure of the maximum deviation, in LSB, from a straight line passing through the endpoints of the DAC transfer function. A typical INL error vs. code plot is shown in Figure 5.

### Differential Nonlinearity (DNL)

Differential nonlinearity is the difference between the measured change and the ideal 1 LSB change between any two adjacent codes. A specified differential nonlinearity of  $\pm 1$  LSB maximum ensures monotonicity. This DAC is guaranteed monotonic. A typical DNL error vs. code plot is shown in Figure 9.

### Linearity Error Long-Term Stability

Linearity error long-term stability is a measure of the stability of the linearity of the DAC over a long period of time. It is specified in LSB for a time period of 500 hours and 1000 hours at an elevated ambient temperature.

### Zero-Scale Error

Zero-scale error is a measure of the output error when zero-scale code (0x00000) is loaded to the DAC register. Ideally, the output voltage should be  $V_{REFN}$ . Zero-scale error is expressed in LSBs.

### Zero-Scale Error Temperature Coefficient

Zero-scale error temperature coefficient is a measure of the change in zero-scale error with a change in temperature. It is expressed in ppm FSR/ $^{\circ}$ C.

### Full-Scale Error

Full-scale error is a measure of the output error when full-scale code (0x0FFFF) is loaded to the DAC register. Ideally, the output voltage should be  $V_{REFP} - 1$  LSB. Full-scale error is expressed in LSBs.

### Full-Scale Error Temperature Coefficient

Full-scale error temperature coefficient is a measure of the change in full-scale error with a change in temperature. It is expressed in ppm FSR/ $^{\circ}$ C.

### Gain Error

Gain error is a measure of the span error of the DAC. It is the deviation in slope of the DAC transfer characteristic from the ideal, expressed in ppm of the full-scale range.

### Gain Error Temperature Coefficient

Gain error temperature coefficient is a measure of the change in gain error with a change in temperature. It is expressed in ppm FSR/ $^{\circ}$ C.

### Midscale Error

Midscale error is a measure of the output error when midscale code (0x08000) is loaded to the DAC register. Ideally, the output voltage should be  $(V_{REFP} - V_{REFN})/2 + V_{REFN}$ . Midscale error is expressed in LSBs.

### Output Voltage Settling Time

Output voltage settling time is the amount of time it takes for the output voltage to settle to a specified level for a specified change in voltage. For fast settling applications, a high speed buffer amplifier is required to buffer the load from the 3.4 k $\Omega$  output impedance of the AD5760, in which case, it is the amplifier that determines the settling time.

### Digital-to-Analog Glitch Impulse

Digital-to-analog glitch impulse is the impulse injected into the analog output when the input code in the DAC register changes state. It is specified as the area of the glitch in nV-sec and is measured when the digital input code is changed by 1 LSB at the major carry transition (see Figure 48).

### Output Enabled Glitch Impulse

Output enabled glitch impulse is the impulse injected into the analog output when the clamp to ground on the DAC output is removed. It is specified as the area of the glitch in nV-sec (see Figure 48).

### Digital Feedthrough

Digital feedthrough is a measure of the impulse injected into the analog output of the DAC from the digital inputs of the DAC but is measured when the DAC output is not updated. It is specified in nV-sec and measured with a full-scale code change on the data bus, that is, from all 0s to all 1s, and vice versa.

### Total Harmonic Distortion (THD)

Total harmonic distortion is the ratio of the rms sum of the harmonics of the DAC output to the fundamental value. Only the second to fifth harmonics are included.

### DC Power Supply Rejection Ratio.

DC power supply rejection ratio is a measure of the rejection of the output voltage to dc changes in the power supplies applied to the DAC. It is measured for a given dc change in power supply voltage and is expressed in  $\mu$ V/V.

### AC Power Supply Rejection Ratio (AC PSRR)

AC power supply rejection ratio is a measure of the rejection of the output voltage to ac changes in the power supplies applied to the DAC. It is measured for a given amplitude and frequency change in power supply voltage and is expressed in decibels.

## THEORY OF OPERATION

The **AD5760** is a high accuracy, fast settling, single, 16-bit, serial input, voltage output DAC. It operates from a  $V_{DD}$  supply voltage of 7.5 V to 16.5 V and a  $V_{SS}$  supply of  $-16.5$  V to  $-2.5$  V. Data is written to the **AD5760** in a 24-bit word format via a 3-wire serial interface. The **AD5760** incorporates a power-on reset circuit that ensures the DAC output powers up to 0 V with the  $V_{OUT}$  pin clamped to AGND through a  $\sim 6$  k $\Omega$  internal resistor.

### DAC ARCHITECTURE

The architecture of the **AD5760** consists of two matched DAC sections. A simplified circuit diagram is shown in Figure 49. The six MSBs of the 16-bit data-word are decoded to drive 63 switches, E0 to E62. Each of these switches connects one of 63 matched resistors to either the buffered  $V_{REFP}$  or buffered  $V_{REFN}$  voltage. The remaining 10 bits of the data-word drive the S0 to S9 switches of a 10-bit voltage mode R-2R ladder network.

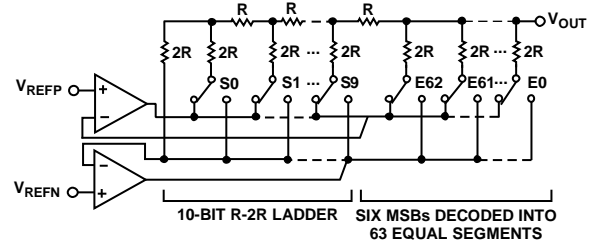

Figure 49. DAC Ladder Structure Serial Interface

### SERIAL INTERFACE

The **AD5760** has a 3-wire serial interface ( $\overline{\text{SYNC}}$ , SCLK, and SDIN) that is compatible with SPI, QSPI, and MICROWIRE interface standards, as well as most DSPs (see Figure 2 for a timing diagram).

#### Input Shift Register

The input shift register is 24 bits wide. Data is loaded into the device MSB first as a 24-bit word under the control of a serial clock input, SCLK, which can operate at up to 35 MHz. The input register consists of a R/W bit, three address bits, and 20 data bits as shown in Table 6. The timing diagram for this operation is shown in Figure 2.

Table 6. Input Shift Register Format

MSB				LSB
DB23	DB22	DB21	DB20	DB19 to DB0
R/W	Register address			Register data

Table 7. Decoding the Input Shift Register

R/W	Register Address			Description
X <sup>1</sup>	0	0	0	No operation (NOP). Used in readback operations.
0	0	0	1	Write to the DAC register.
0	0	1	0	Write to the control register.
0	0	1	1	Write to the clearcode register.
0	1	0	0	Write to the software control register.
1	0	0	1	Read from the DAC register.
1	0	1	0	Read from the control register.
1	0	1	1	Read from the clearcode register.

<sup>1</sup> X is don't care.

### Standalone Operation

The serial interface works with both a continuous and noncontinuous serial clock. A continuous SCLK source can be used only if SYNC is held low for the correct number of clock cycles.

In gated clock mode, a burst clock containing the exact number of clock cycles must be used, and SYNC must be taken high after the final clock to latch the data. The first falling edge of SYNC starts the write cycle. Exactly 24 falling clock edges must be applied to SCLK before SYNC is brought high again. If SYNC is brought high before the 24<sup>th</sup> falling SCLK edge, the data written is invalid. If more than 24 falling SCLK edges are applied before SYNC is brought high, the input data is also invalid.

The input shift register is updated on the rising edge of SYNC. For another serial transfer to take place, SYNC must be brought low again. After the end of the serial data transfer, data is automatically transferred from the input shift register to the addressed register. When the write cycle is complete, the output can be updated by taking LDAC low while SYNC is high.

### Readback

The contents of all the on-chip registers can be read back via the SDO pin. Table 7 outlines how the registers are decoded. After a register has been addressed for a read, the next 24 clock cycles clock the data out on the SDO pin. The clocks must be applied while SYNC is low. When SYNC is returned high, the SDO pin is placed in tristate. For a read of a single register, the NOP function can be used to clock out the data. Alternatively, if more than one register is to be read, the data of the first register to be addressed can be clocked out at the same time that the second register to be read is being addressed. The SDO pin must be enabled to complete a readback operation. The SDO pin is enabled by default.

## HARDWARE CONTROL PINS

### Load DAC Function (LDAC)

After data has been transferred into the input register of the DAC, there are two ways to update the DAC register and DAC output. Depending on the status of both SYNC and LDAC, one of two update modes is selected: synchronous DAC update or asynchronous DAC update.

### Synchronous DAC Update

In this mode, LDAC is held low while data is being clocked into the input shift register. The DAC output is updated on the rising edge of SYNC.

### Asynchronous DAC Update

In this mode, LDAC is held high while data is being clocked into the input shift register. The DAC output is asynchronously updated by taking LDAC low after SYNC has been taken high. The update now occurs on the falling edge of LDAC.

### Reset Function (RESET)

The AD5760 can be reset to its power-on state by two means: either by asserting the RESET pin or by using the reset function in the software control register (see Table 13). If the RESET pin is not used, hardwire it to IOV<sub>CC</sub>.

### Asynchronous Clear Function (CLR)

The CLR pin is an active low clear that allows the output to be cleared to a user defined value. The 16-bit clearcode value is programmed to the clearcode register (see Table 12). It is necessary to maintain CLR low for a minimum amount of time to complete the operation (see Figure 2). When the CLR signal is returned high, the output remains at the clear value (if LDAC is high) until a new value is loaded to the DAC register. The output cannot be updated with a new value while the CLR pin is low. A clear operation can also be performed by setting the CLR bit in the software control register (see Table 13).

## ON-CHIP REGISTERS

### DAC Register

Table 9 outlines how data is written to and read from the DAC register.

The following equation describes the ideal transfer function of the DAC:

$$V_{OUT} = \frac{(V_{REFP} - V_{REFN}) \times D}{2^{16}} + V_{REFN}$$

where:

$V_{REFN}$  is the negative voltage applied at the  $V_{REFN}$  input pin.

$V_{REFP}$  is the positive voltage applied at the  $V_{REFP}$  input pin.

$D$  is the 16-bit code programmed to the DAC.

Table 8. Hardware Control Pins Truth Table

LDAC	CLR	RESET	Function
X <sup>1</sup>	X <sup>1</sup>	0	The AD5760 is in reset mode. The device cannot be programmed.
X <sup>1</sup>	X <sup>1</sup>	$\uparrow$	The AD5760 is returned to its power-on state. All registers are set to their default values.
0	0	1	The DAC register is loaded with the clearcode register value, and the output is set accordingly.
0	1	1	The output is set according to the DAC register value.
1	0	1	The DAC register is loaded with the clearcode register value, and the output is set accordingly.
$\downarrow$	1	1	The output is set according to the DAC register value.
$\downarrow$	0	1	The output remains at the clearcode register value.
$\uparrow$	1	1	The output remains set according to the DAC register value.
$\uparrow$	0	1	The output remains at the clearcode register value.
1	$\downarrow$	1	The DAC register is loaded with the clearcode register value and the output is set accordingly.
0	$\downarrow$	1	The DAC register is loaded with the clearcode register value and the output is set accordingly.
1	$\uparrow$	1	The output remains at the clearcode register value.
0	$\uparrow$	1	The output is set according to the DAC register value.

<sup>1</sup> X is don't care.

Table 9. DAC Register

MSB							LSB	
DB23	DB22	DB21	DB20	DB19 to DB4	DB3	DB2	DB1	DB0
R/W	Register address			DAC register data				
R/W	0	0	1	16 bits of data	X <sup>1</sup>	X <sup>1</sup>	X <sup>1</sup>	X <sup>1</sup>

<sup>1</sup> X is don't care.

**Control Register**

The control register controls the mode of operation of the [AD5760](#).

**Clearcode Register**

The clearcode register sets the value to which the DAC output is set when the CLR pin or CLR bit in the software control register is asserted. The output value depends on the DAC coding that is being used, either binary or twos complement. The default register value is 0.

**Table 10. Control Register**

MSB													LSB		
DB23	DB22	DB21	DB20	DB19 to DB11	DB10	DB9	DB8	DB7	DB6	DB5	DB4	DB3	DB2	DB1	DB0
R/W	Register address			Control register data											
R/W	0	1	0	Reserved	Reserved	0000			SDODIS	BIN/2sC	DACTRI	OPGND	RBUF	Reserved	

**Table 11. Control Register Functions**

Bit Name	Description
Reserved	These bits are reserved and should be programmed to zero.
RBUF	Output amplifier configuration control. 0: the internal amplifier, A1, is powered up and Resistors $R_{FB}$ and R1 are connected in series, as shown in Figure 53. This allows an external amplifier to be connected in a gain of two configuration. See the AD5760 Features section for further details. 1: (default) the internal amplifier, A1, is powered down and Resistors $R_{FB}$ and R1 are connected in parallel, as shown in Figure 52, so that the resistance between the RFB and INV pins is 3.4 k $\Omega$ , equal to the resistance of the DAC. This allows the $R_{FB}$ and INV pins to be used for input bias current compensation for an external unity-gain amplifier. See the AD5760 Features section for further details.
OPGND	Output ground clamp control. 0: the DAC output clamp to ground is removed, and the DAC is placed in normal mode. 1: (default) the DAC output is clamped to ground through a ~6 k $\Omega$ resistance, and the DAC is placed in tristate mode. Resetting the device puts the DAC in OPGND mode, where the output ground clamp is enabled and the DAC is tristated. Setting the OPGND bit to 1 in the control register overrules any write to the DACTRI bit.
DACTRI	DAC tristate control. 0: the DAC is in normal operating mode. 1: (default) the DAC is in tristate mode.
BIN/2sC	DAC register coding selection. 0: (default) the DAC register uses twos complement coding. 1: the DAC register uses offset binary coding.
SDODIS	SDO pin enable/disable control. 0: (default) the SDO pin is enabled. 1: the SDO pin is disabled (tristate).
R/W	Read/write select bit. 0: <a href="#">AD5760</a> is addressed for a write operation. 1: <a href="#">AD5760</a> is addressed for a read operation.

**Table 12. Clearcode Register**

MSB										LSB	
DB23	DB22	DB21	DB20	DB19 to DB4	DB3	DB2	DB1	DB0			
R/W	Register address			Clearcode register data							
R/W	0	1	1	16 bits of data			X <sup>1</sup>	X <sup>1</sup>	X <sup>1</sup>	X <sup>1</sup>	

<sup>1</sup> X is don't care.

**Software Control Register**

This is a write only register in which writing a 1 to a particular bit has the same effect as pulsing the corresponding pin low.

**Table 13. Software Control Register**

MSB				LSB			
DB23	DB22	DB21	DB20	DB19 to DB3	DB2	DB1	DB0
R/W	Register address			Software control register data			
0	1	0	0	Reserved	Reset	CLR <sup>1</sup>	LDAC <sup>2</sup>

<sup>1</sup> The CLR function has no effect when the  $\overline{\text{LDAC}}$  pin is low.

<sup>2</sup> The LDAC function has no effect when the CLR pin is low.

**Table 14. Software Control Register Functions**

Bit Name	Description
LDAC	Setting this bit to 1 updates the DAC register and, consequently, the DAC output.
CLR	Setting this bit to 1 sets the DAC register to a user defined value (see Table 12) and updates the DAC output. The output value depends on the DAC register coding that is being used, either binary or twos complement.
Reset	Setting this bit to 1 returns the <a href="#">AD5760</a> to its power-on state.

## AD5760 FEATURES

### POWER-ON TO 0 V

The AD5760 contains a power-on reset circuit that, as well as resetting all registers to their default values, controls the output voltage during power-up. Upon power-on, the DAC is placed in tristate (its reference inputs are disconnected), and its output is clamped to AGND through a ~6 kΩ resistor. The DAC remains in this state until programmed otherwise via the control register. This is a useful feature in applications where it is important to know the state of the DAC output while it is in the process of powering up.

### POWER-UP SEQUENCE

To power up the device in a known safe state, power up the V<sub>DD</sub> supply before powering up the V<sub>CC</sub> supply. This step ensures that V<sub>CC</sub> does not come up while V<sub>DD</sub> is unpowered during power-on. If the device cannot be powered-up in a safe state, connect an external Schottky diode across the V<sub>DD</sub> and V<sub>CC</sub> supplies as shown in Figure 50.

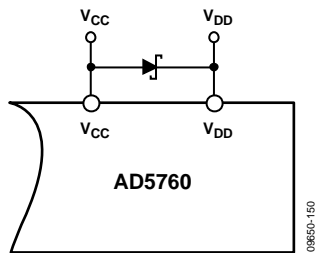

Figure 50. Schottky Diode Connection

### CONFIGURING THE AD5760

After power-on, the AD5760 must be configured to put it into normal operating mode before programming the output. To do this, the control register must be programmed. The DAC is removed from tristate by clearing the DACTRI bit, and the output clamp is removed by clearing the OPGND bit. At this point, the output goes to V<sub>REFN</sub> unless an alternative value is first programmed to the DAC register.

### DAC OUTPUT STATE

The DAC output can be placed in one of three states, controlled by the DACTRI and OPGND bits of the control register, as shown in Table 15.

Table 15. Output State Truth Table

DACTRI	OPGND	Output State
0	0	Normal operating mode.
0	1	Output is clamped via ~6 kΩ to AGND.
1	0	Output is in tristate.
1	1	Output is clamped via ~6 kΩ to AGND.

### OUTPUT AMPLIFIER CONFIGURATION

There are a number of different ways that an output amplifier can be connected to the AD5760, depending on the voltage references applied and the desired output voltage span.

#### Unity-Gain Configuration

Figure 51 shows an output amplifier configured for unity gain. In this configuration, the output spans from V<sub>REFN</sub> to V<sub>REFP</sub>.

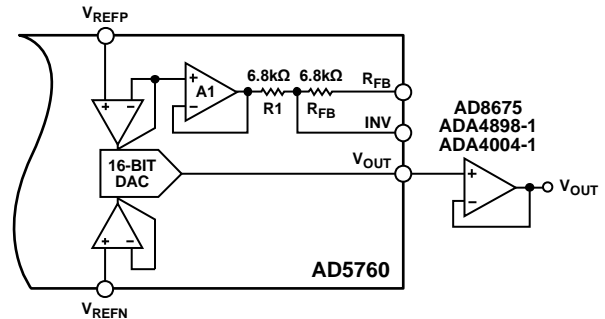

Figure 51. Output Amplifier in Unity-Gain Configuration

A second unity-gain configuration for the output amplifier is one that removes an offset from the input bias currents of the amplifier. It does this by inserting a resistance in the feedback path of the amplifier that is equal to the output resistance of the DAC. The DAC output resistance is 3.4 kΩ. By connecting R1 and R<sub>FB</sub> in parallel, a resistance equal to the DAC resistance is available on chip. Because the resistors are all on one piece of silicon, they are temperature coefficient matched. To enable this mode of operation, the RBUF bit of the control register must be set to Logic 1. Figure 52 shows how the output amplifier is connected to the AD5760. In this configuration, the output amplifier is in unity gain, and the output spans from V<sub>REFN</sub> to V<sub>REFP</sub>. This unity-gain configuration allows a capacitor to be placed in the amplifier feedback path to improve dynamic performance.

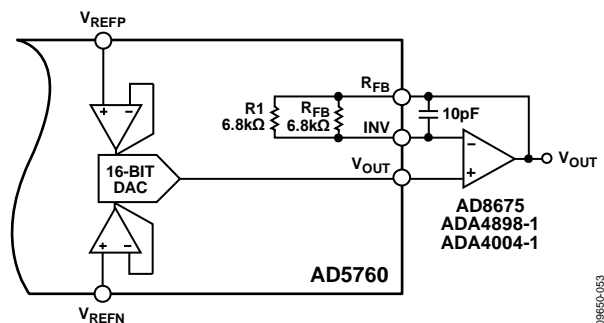

Figure 52. Output Amplifier in Unity-Gain with Amplifier Input Bias Current Compensation

### Gain of Two Configuration ( $\times 2$ Gain Mode)

Figure 53 shows an output amplifier configured for a gain of two. The gain is set by the internal matched  $6.8\text{ k}\Omega$  resistors, which are exactly twice the DAC resistance, having the effect of removing an offset from the input bias current of the external amplifier. In this configuration, the output spans from  $2 \times V_{\text{REFN}} - V_{\text{REFP}}$  to  $V_{\text{REFP}}$ . This configuration is used to generate a bipolar output span from a single-ended reference input, with  $V_{\text{REFN}} = 0\text{ V}$ . For this mode of operation, the RBUF bit of the control register must be cleared to Logic 0.

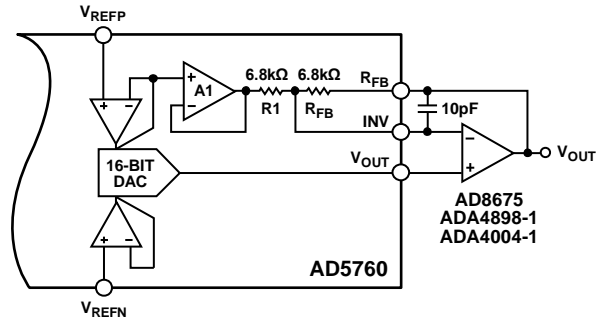

Figure 53. Output Amplifier in Gain of Two Configuration

08650-054



APPLICATIONS INFORMATION  
TYPICAL OPERATING CIRCUIT

590-05960

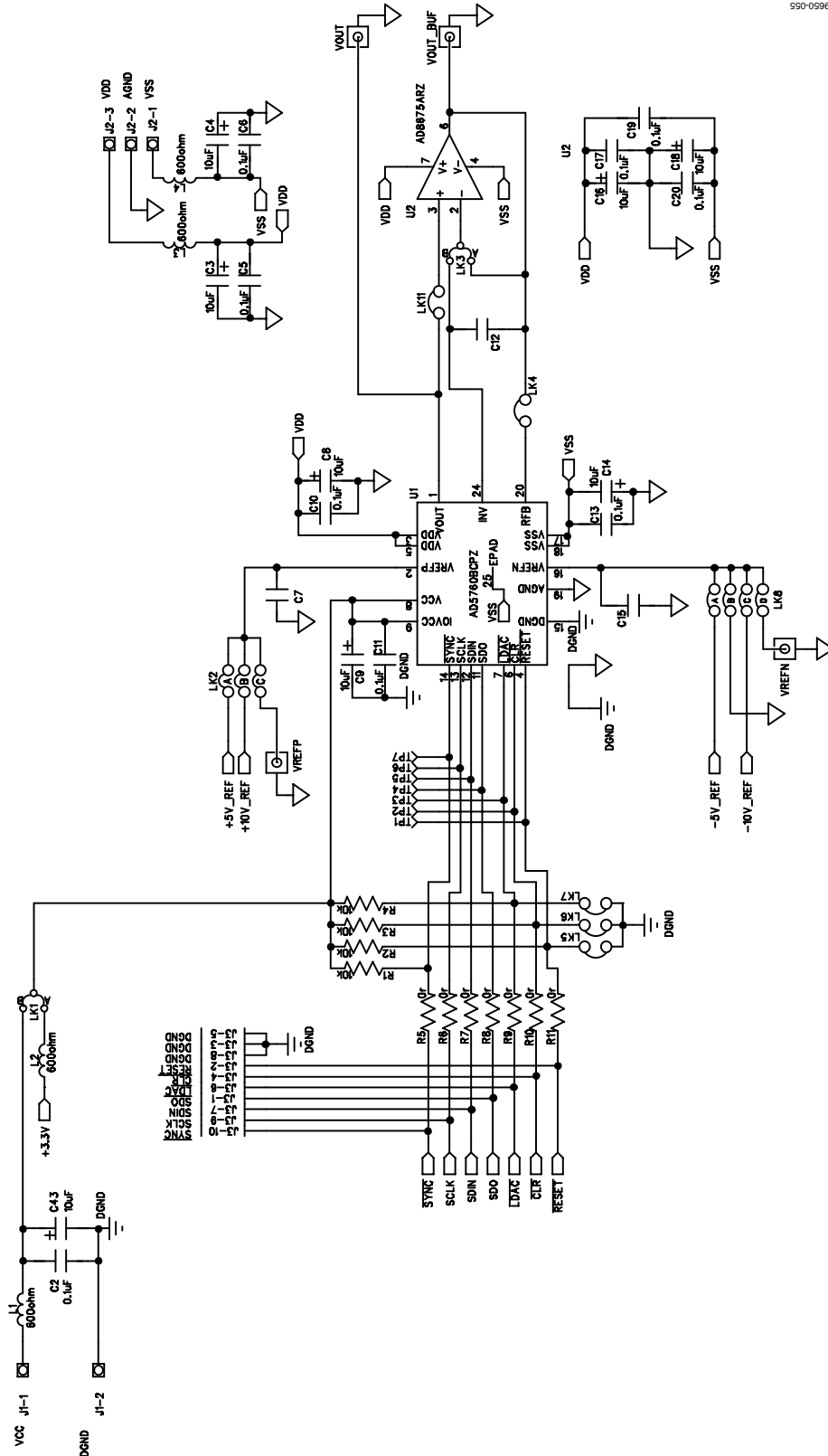

Figure 54. Typical Operating Circuit

Figure 54 shows a typical operating circuit for the [AD5760](#) using an [AD8675](#) as an output buffer. Because the output impedance of the [AD5760](#) is 3.4 k $\Omega$ , an output buffer is required for driving low resistive, high capacitive loads.

#### **EVALUATION BOARD**

Refer to the evaluation board available for the [AD5780](#) or [AD5790](#) to evaluate a 18-bit version or 20-bit version of the [AD5760](#). An evaluation board is available for the [AD5780](#)

to aid designers in evaluating the high performance of the device with minimum effort. The evaluation kit includes a populated and tested [AD5780](#) printed circuit board (PCB). The evaluation board interfaces to the USB port of a PC. Software is available with the evaluation board to allow the user to easily program the [AD5780](#). The software runs on any PC that has Microsoft® Windows® XP (SP2), Vista (32-bit or 64-bit), or Windows 7 installed. The [UG-256](#) is available, which gives full details on the operation of the evaluation board

OUTLINE DIMENSIONS

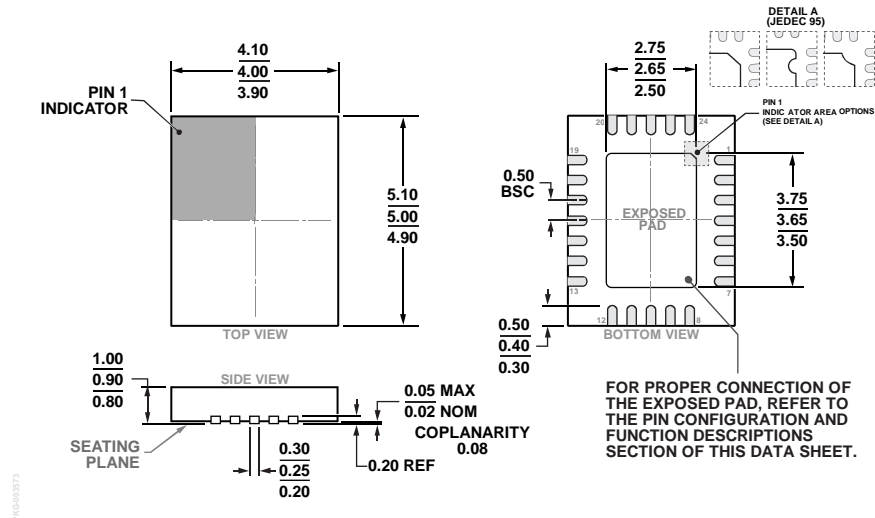

Figure 55. 24-Lead Lead Frame Chip Scale Package [LFCSP]  
 4 mm × 5 mm Body and 0.90 mm Package Height  
 (CP-24-5)  
 Dimensions shown in millimeters

ORDERING GUIDE

Model <sup>1</sup>	Temperature Range	INL	Package Description	Package Option
AD5760BCPZ	−40°C to +125°C	±0.5 LSB	24-Lead Lead Frame Chip Scale Package [LFCSP]	CP-24-5
AD5760BCPZ-REEL7	−40°C to +125°C	±0.5 LSB	24-Lead Lead Frame Chip Scale Package [LFCSP]	CP-24-5
AD5760ACPZ	−40°C to +125°C	±2 LSB	24-Lead Lead Frame Chip Scale Package [LFCSP]	CP-24-5
AD5760ACPZ-REEL7	−40°C to +125°C	±2 LSB	24-Lead Lead Frame Chip Scale Package [LFCSP]	CP-24-5
EVAL-AD5760SDZ			Evaluation Board	

<sup>1</sup> Z = RoHS Compliant Part.



Компания «ЭлектроПласт» предлагает заключение долгосрочных отношений при поставках импортных электронных компонентов на взаимовыгодных условиях!

Наши преимущества:

- Оперативные поставки широкого спектра электронных компонентов отечественного и импортного производства напрямую от производителей и с крупнейших мировых складов;
- Поставка более 17-ти миллионов наименований электронных компонентов;
- Поставка сложных, дефицитных, либо снятых с производства позиций;
- Оперативные сроки поставки под заказ (от 5 рабочих дней);
- Экспресс доставка в любую точку России;
- Техническая поддержка проекта, помощь в подборе аналогов, поставка прототипов;
- Система менеджмента качества сертифицирована по Международному стандарту ISO 9001;
- Лицензия ФСБ на осуществление работ с использованием сведений, составляющих государственную тайну;
- Поставка специализированных компонентов (Xilinx, Altera, Analog Devices, Intersil, Interpoint, Microsemi, Aeroflex, Peregrine, Syfer, Eurofarad, Texas Instrument, Miteq, Cobham, E2V, MA-COM, Hittite, Mini-Circuits, General Dynamics и др.);

Помимо этого, одним из направлений компании «ЭлектроПласт» является направление «Источники питания». Мы предлагаем Вам помощь Конструкторского отдела:

- Подбор оптимального решения, техническое обоснование при выборе компонента;
- Подбор аналогов;
- Консультации по применению компонента;
- Поставка образцов и прототипов;
- Техническая поддержка проекта;
- Защита от снятия компонента с производства.



#### Как с нами связаться

**Телефон:** 8 (812) 309 58 32 (многоканальный)

**Факс:** 8 (812) 320-02-42

**Электронная почта:** [org@eplast1.ru](mailto:org@eplast1.ru)

**Адрес:** 198099, г. Санкт-Петербург, ул. Калинина, дом 2, корпус 4, литера А.