

COMPACT HIGH POWER RELAY

1 POLE—30 A

(FOR AUTOMOTIVE APPLICATIONS)

FBR56 SERIES

RoHS compliant

■ FEATURES

- High power contact capacity
(carrying current: 40 A/10 minutes, 30 A/1 hour)
- High heat resistance and extended operating voltage
- RoHS compliant since date code: 0627
Please see page 8 for more information



■ ORDERING INFORMATION

[Example] $\frac{\text{FBR56}}{\text{(a)}} \frac{\text{N}}{\text{(b)}} \frac{\text{D12}}{\text{(c)}} - \frac{\text{W1}}{\text{(d)}} \frac{\text{**}}{\text{(e)}}$

(a)	Series Name	FBR56 : FBR56 Series relay for 12 V battery (contact gap 0.4 mm)
(b)	Enclosure	N : Plastic sealed type
(c)	Nominal Voltage	D06 : 6 VDC D09 : 9 VDC D12 : 12 VDC
(d)	Contact Material	W1: Silver-tin oxide indium Y: Silver-tin oxide
(e)	Custom Designation	To be assigned custom specification

FBR56 SERIES

■ SPECIFICATIONS

Item		Specifications	
Contact	Arrangement	1 form C	
	Material	Silver-tin oxide indium (-W1 type), silver tin oxide (-Y type)	
	Voltage Drop (resistance)	Maximum 100 mV (at 1A, 12VDC)	
	Ratings	14 VDC 30 A (locked motor load) 14 VDC inrush 27A, break 4A (motor free load)	
	Maximum Carrying Current	40A/10 minutes, 30A/1 hour (25°C, 100% rated coil voltage)	
	Maximum Inrush Current	70A (reference)	
	Maximum Switching Current	40A, 16VDC (reference)	
	Minimum Switching Load*1	6VDC, 1A	
Coil	Operating Temperature	-40°C to +85°C (no frost) (refer to the CHARACTERISTIC DATA)	
	Storage Temperature	-40°C to +100°C (no frost)	
Time Value	Operate (at nominal voltage)	Maximum 10 ms	
	Release (at nominal voltage)	Maximum 5 ms	
Life	Mechanical	10 × 10 ⁶ operations minimum	
	Electrical	100 × 10 ³ operations minimum (locked motor load) 1 × 10 ⁶ operations minimum (motor free load)	
Other	Vibration Resistance		10 to 55 Hz (double amplitude of 1.5 mm)
	Shock Resistance	Misoperation	100 m/s ²
		Endurance	1,000 m/s ²
	Weight		Approximately 9.4 g

*1 Values when switching a resistive load at normal room temperature and humidity, and in a clean environment.
The minimum switching load varies with the switching frequency and operating environment.

■ COIL DATA CHART

MODEL		Nominal voltage	Coil resistance (±10%) (at 20°C)	Must operate voltage	Release voltage
W1 contact	Y contact				
FBR56ND06-W1	FBR56ND06-Y	6 VDC	42 Ω	3.6 VDC (at 20°C) 4.5 VDC (at 85°C)	0.5VDC(at 20°C) 0.6 VDC (at 85°C)
FBR56ND09-W1	FBR56ND09-Y	9 VDC	95 Ω	5.4 VDC (at 20°C) 6.8 VDC (at 85°C)	0.7 VDC (at 20°C) 0.8 VDC (at 85°C)
FBR56ND12-W1	FBR56ND12-Y	12 VDC	170 Ω	7.3 VDC (at 20°C) 9.2 VDC (at 85°C)	1.0 VDC (at 20°C) 1.2 VDC (at 85°C)

FBR56 SERIES

■ PRINCIPAL APPLICATIONS

Application		Normal load current	Life x 10 ³	Recommended model (Example)
For 12 V battery	Power Windows	20 to 30 A (switching at motor locking)	100	FBR56N□-Y
	Automatic Door Lock	18 to 30 A/4 to 5 door (switching at motor locking)	100	FBR56N□-Y
	Intermittent Wipers	INRUSH 15 to 30 A BREAK 2 to 8 A (motor free)	300	FBR56N□-W1
	Tilt-Lock Wheel	INRUSH 15 A BREAK 2.5 A (motor free)	100	FBR56N□-Y
	Sunroof	20 to 30 A (switching at motor locking)	100	FBR56N□-Y
	Others	Car audio system, etc.	—	FBR56N□-Y

■ CHARACTERISTIC DATA

1. MAXIMUM BREAK CAPACITY

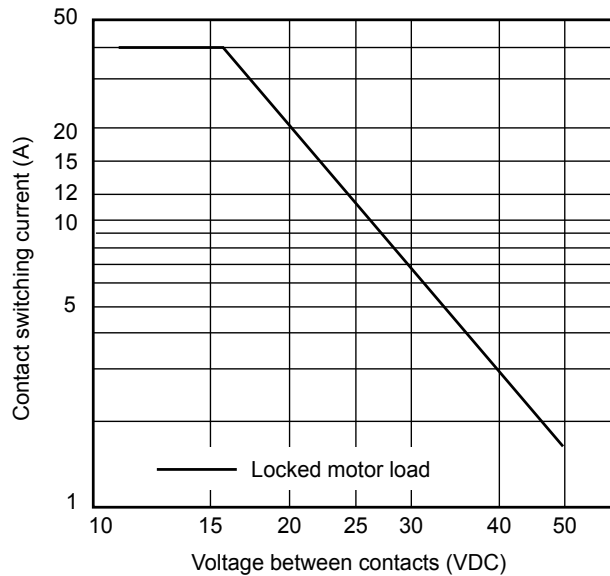

2. LIFE

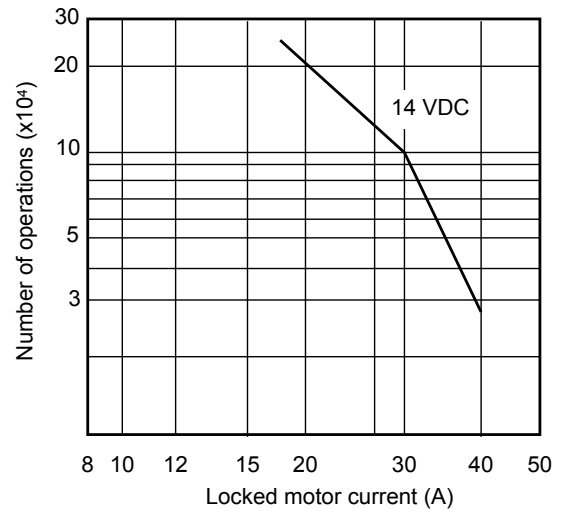

3. LIFE TEST (EXAMPLE)

- Test item
14 V DC-20 A
Motor lock
200,000 operations minimum
(FBR56 □-W1 type)
- Test circuit

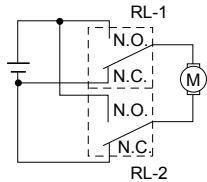

- Shift of pick-up and drop-out voltage

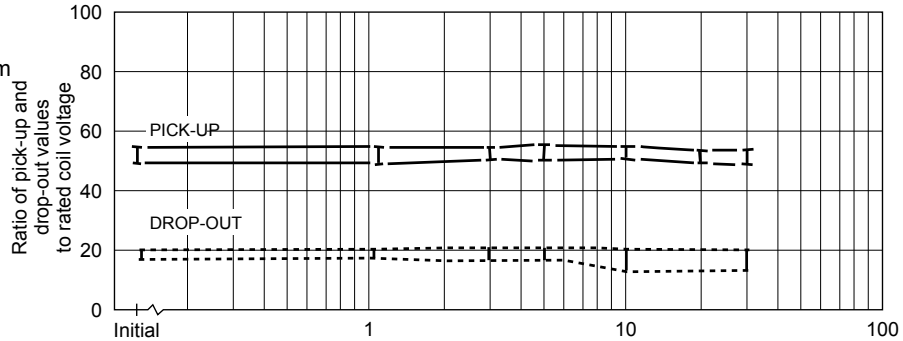

- Current wave form

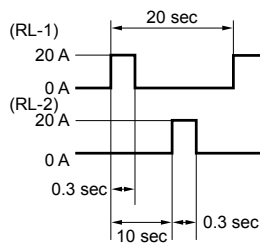

- Shift of contact resistance

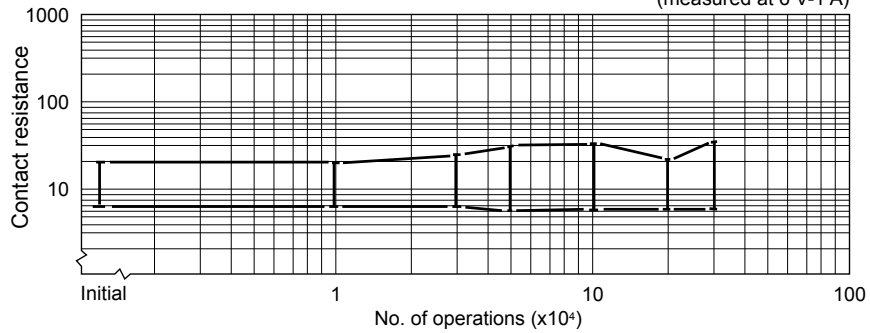

- Test item
14 V DC-30 A
Motor lock
100,000 operations minimum
(FBR56 □-W1 type)
- Test circuit

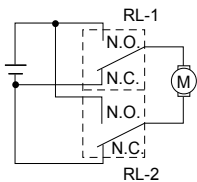

- Shift of pick-up and drop-out voltage

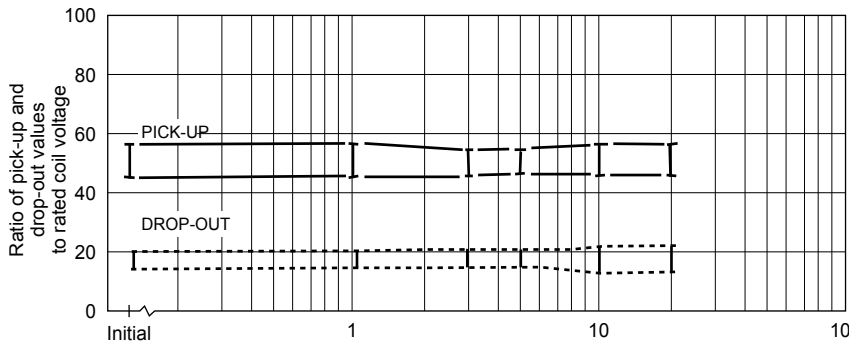

- Current wave form

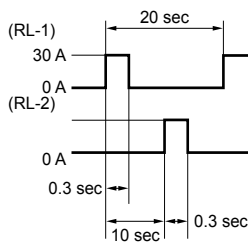

- Shift of contact resistance

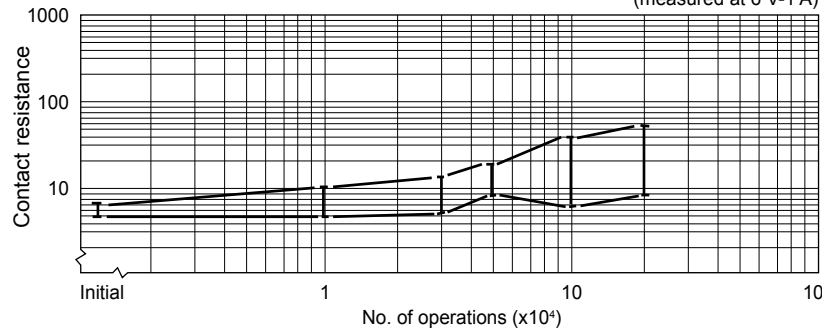

(Continued)

FBR56 SERIES

(Continued)

- Test item
14V DC- 27A INRUSH 4A break
Motor free
400,000 operations minimum
(FBR56 □-W1 type)

• Test circuit

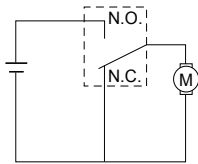

• Shift of pick-up and drop-out voltage

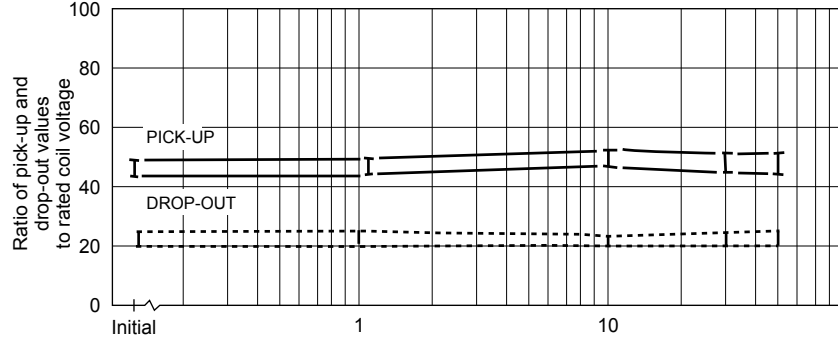

• Current wave form

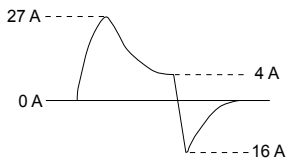

• Shift of contact resistance

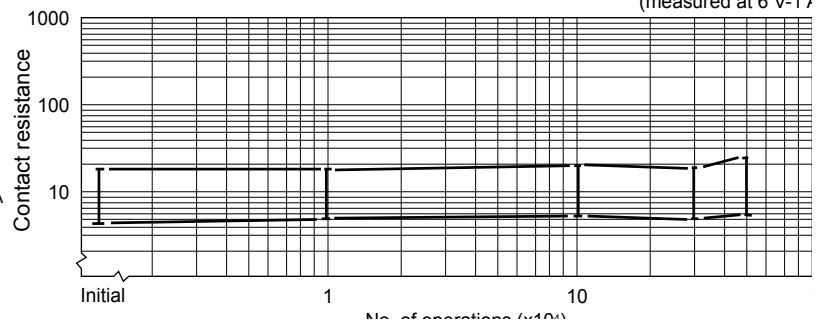

4. COIL TEMPERATURE RISE

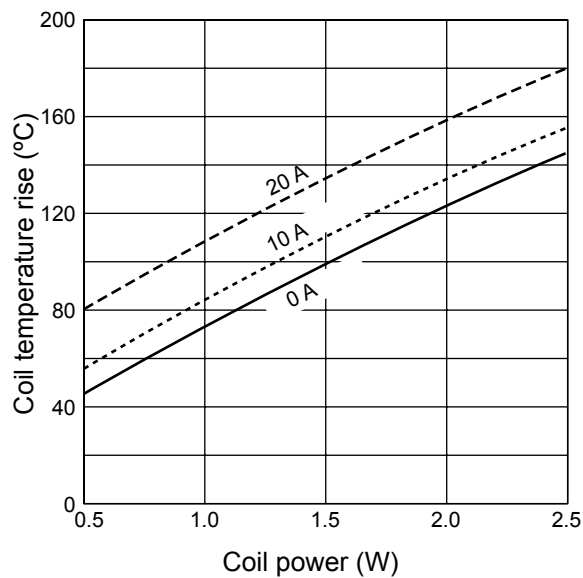

5. OPERATING COIL VOLTAGE RANGE (EXAMPLE)

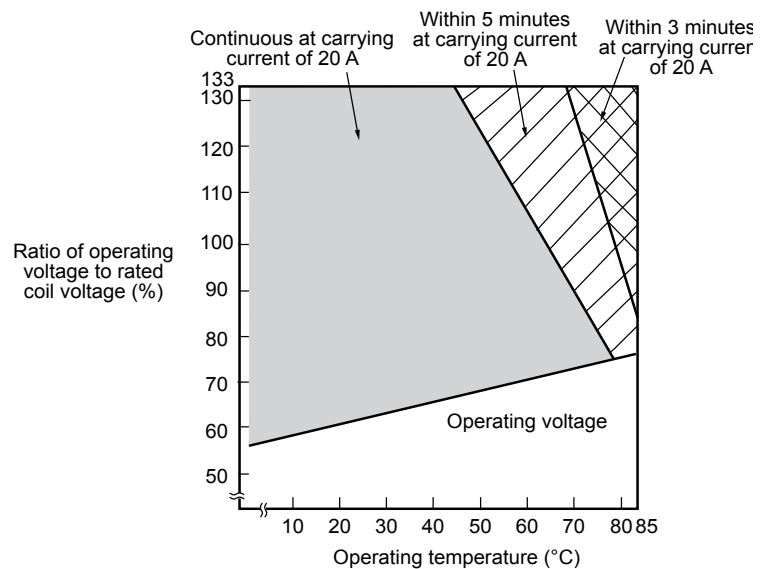

FBR56 SERIES

6. VIBRATION RESISTANCE CHARACTERISTICS

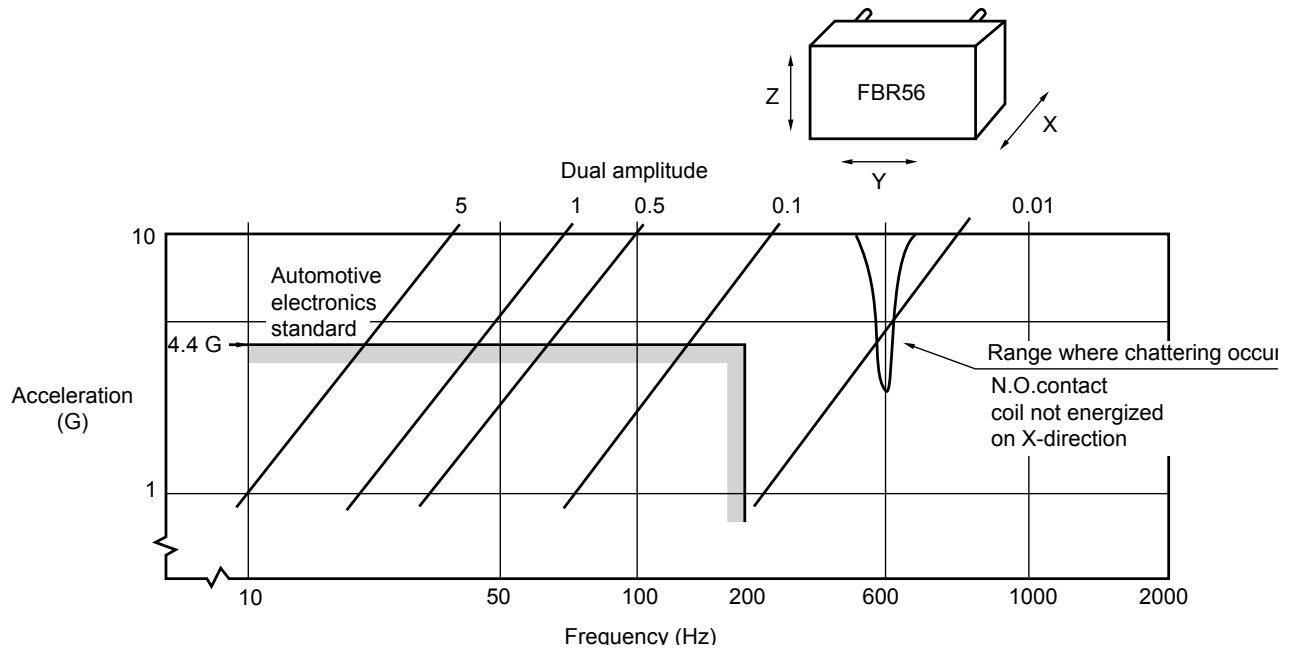

7. SHOCK RESISTANCE CHARACTERISTICS

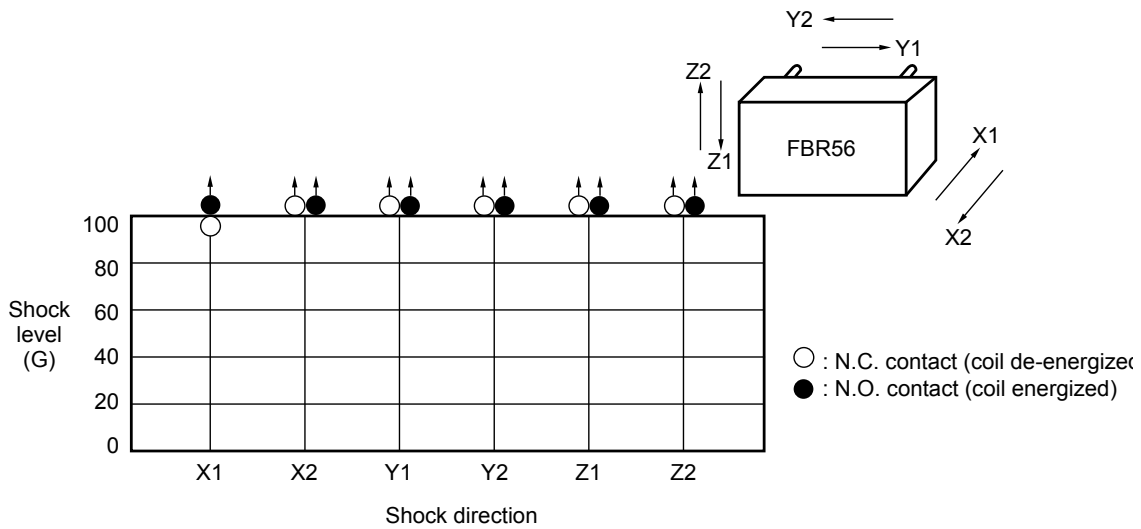

FBR56 SERIES

REFERENCE DATA

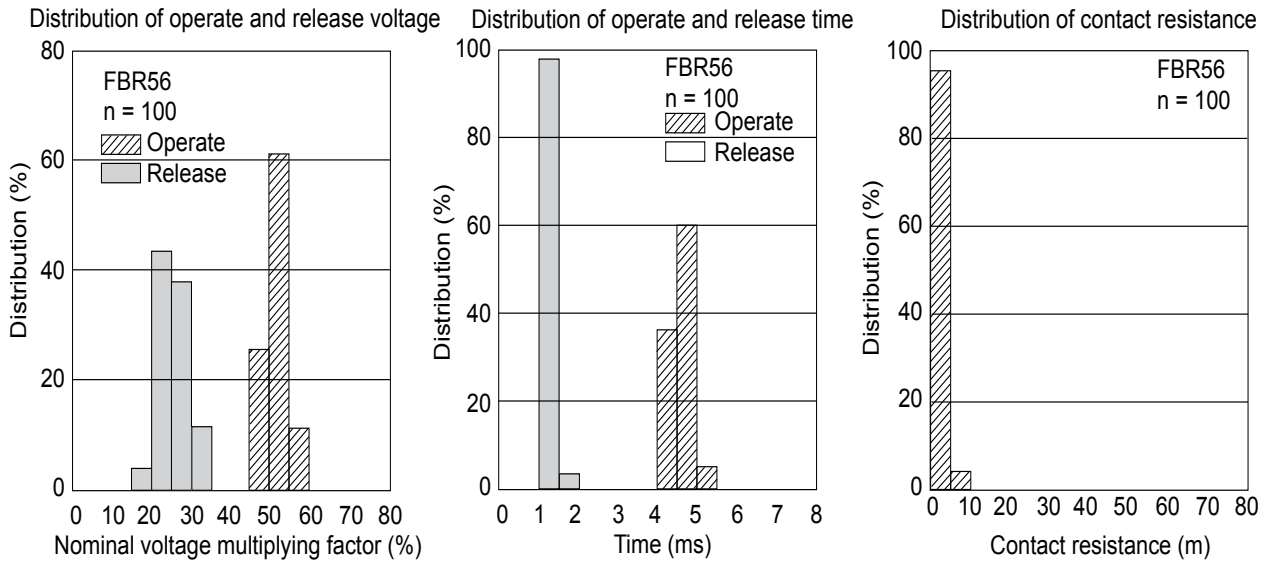

DIMENSIONS

Dimensions

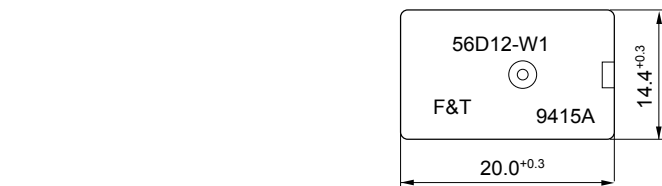

PC board mounting hole layout (BOTTOM VIEW)

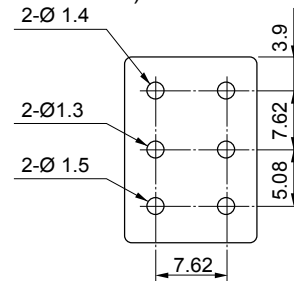

Schematics (BOTTOM VIEW)

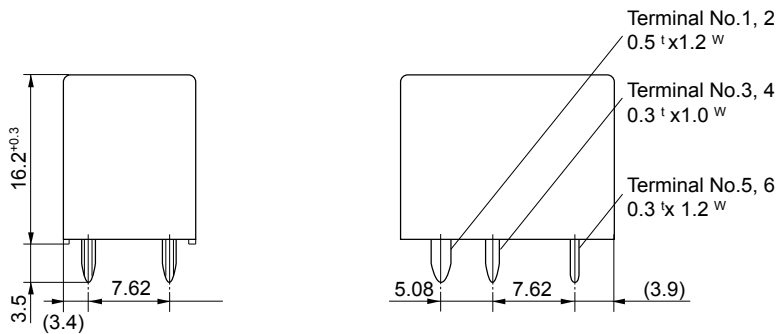
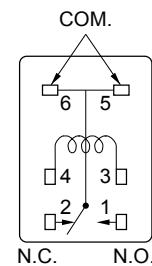

Tube carrier

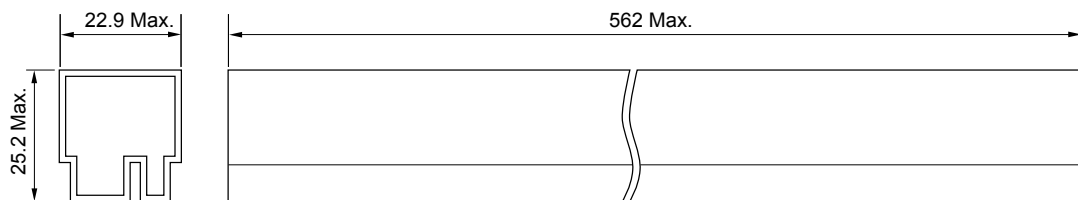

35 pcs/tube

Unit : mm

RoHS Compliance and Lead Free Relay Information

1. General Information

- Relays produced after the specific date code that is indicated on each data sheet are lead-free now. Most of our signal and power relays are lead-free. Please refer to Lead-Free Status Info. (<http://www.fujitsu.com/us/downloads/MICRO/fcai/relays/lead-free-letter.pdf>)
- Lead free solder paste currently used in relays is Sn-3.0Ag-0.5Cu.
- All signal and most power relays also comply with RoHS. Please refer to individual data sheets. Relays that are RoHS compliant do not contain the 5 hazardous materials that are restricted by RoHS directive (lead, mercury, chromium IV, PBB, PBDE).
- It has been verified that using lead-free relays in leaded assembly process will not cause any problems (compatible).
- "LF" is marked on each outer and inner carton. (No marking on individual relays).
- To avoid leaded relays (for lead-free sample, etc.) please consult with area sales office.
- We will ship leaded relays as long as the leaded relay inventory exists.

Note: Cadmium was exempted from RoHS on October 21, 2005. (Amendment to Directive 2002/95/EC)

2. Recommended Lead Free Solder Profile

- Recommended solder paste Sn-3.0Ag-0.5Cu.

Reflow Solder condition

Flow Solder condition:

Pre-heating: maximum 120°C
Soldering: dip within 5 sec. at
260°C solder bath

Solder by Soldering Iron:

Soldering Iron
Temperature: maximum 360°C
Duration: maximum 3 sec.

We highly recommend that you confirm your actual solder conditions

3. Moisture Sensitivity

- Moisture Sensitivity Level standard is not applicable to electromechanical relays.

4. Tin Whisker

- Dipped SnAgCu solder is known as low risk tin whisker. No considerable length whisker was found by our in house test.

Fujitsu Components International Headquarter Offices

Japan

Fujitsu Component Limited
Gotanda-Chuo Building
3-5, Higashigotanda 2-chome, Shinagawa-ku
Tokyo 141 8630, Japan
Tel: (81-3) 5449-7010
Fax: (81-3) 5449-2626
Email: promothq@fcl.fujitsu.com
Web: www.fcl.fujitsu.com

North and South America

Fujitsu Components America, Inc.
250 E. Caribbean Drive
Sunnyvale, CA 94089 U.S.A.
Tel: (1-408) 745-4900
Fax: (1-408) 745-4970
Email: components@us.fujitsu.com
Web: <http://www.fujitsu.com/us/services/edevice/components/>

Europe

Fujitsu Components Europe B.V.
Diamantlaan 25
2132 WV Hoofddorp
Netherlands
Tel: (31-23) 5560910
Fax: (31-23) 5560950
Email: info@fceu.fujitsu.com
Web: emea.fujitsu.com/components/

Asia Pacific

Fujitsu Components Asia Ltd.
102E Pasir Panjang Road
#01-01 Citilink Warehouse Complex
Singapore 118529
Tel: (65) 6375-8560
Fax: (65) 6273-3021
Email: fcal@fcal.fujitsu.com
Web: <http://www.fujitsu.com/sg/services/micro/components/>

©2008 Fujitsu Components America, Inc. All rights reserved. All trademarks or registered trademarks are the property of their respective owners.

Fujitsu Components America or its affiliates do not warrant that the content of datasheet is error free. In a continuing effort to improve our products Fujitsu Components America, Inc. or its affiliates reserve the right to change specifications/datasheets without prior notice.
Rev. January 3, 2008.



Компания «ЭлектроПласт» предлагает заключение долгосрочных отношений при поставках импортных электронных компонентов на взаимовыгодных условиях!

Наши преимущества:

- Оперативные поставки широкого спектра электронных компонентов отечественного и импортного производства напрямую от производителей и с крупнейших мировых складов;
- Поставка более 17-ти миллионов наименований электронных компонентов;
- Поставка сложных, дефицитных, либо снятых с производства позиций;
- Оперативные сроки поставки под заказ (от 5 рабочих дней);
- Экспресс доставка в любую точку России;
- Техническая поддержка проекта, помощь в подборе аналогов, поставка прототипов;
- Система менеджмента качества сертифицирована по Международному стандарту ISO 9001;
- Лицензия ФСБ на осуществление работ с использованием сведений, составляющих государственную тайну;
- Поставка специализированных компонентов (Xilinx, Altera, Analog Devices, Intersil, Interpoint, Microsemi, Aeroflex, Peregrine, Syfer, Eurofarad, Texas Instrument, Miteq, Cobham, E2V, MA-COM, Hittite, Mini-Circuits, General Dynamics и др.);

Помимо этого, одним из направлений компании «ЭлектроПласт» является направление «Источники питания». Мы предлагаем Вам помощь Конструкторского отдела:

- Подбор оптимального решения, техническое обоснование при выборе компонента;
- Подбор аналогов;
- Консультации по применению компонента;
- Поставка образцов и прототипов;
- Техническая поддержка проекта;
- Защита от снятия компонента с производства.



Как с нами связаться

Телефон: 8 (812) 309 58 32 (многоканальный)

Факс: 8 (812) 320-02-42

Электронная почта: org@eplast1.ru

Адрес: 198099, г. Санкт-Петербург, ул. Калинина, дом 2, корпус 4, литера А.