



The Future of Analog IC Technology®

# MP4088

## Non-Isolated, High PFC, TRIAC Dimmable LED Driver for 230VAC, Up to 10W LEDs

### DESCRIPTION

The MP4088 is a highly integrated, TRIAC dimmable LED driver with an integrated 500V MOSFET that regulates precise LED currents in non-isolated lighting applications and requires only a single winding inductor. The MP4088 features MPS' proprietary hybrid operation mode, which is designed to achieve optimal dimming performance. The MP4088 is designed specifically for high-line input (230VAC) and TRIAC dimmable LED lighting applications, especially for low-cost and small form-factor applications.

The accurate output LED current is achieved by an internal averaging current feedback loop. An internal high-voltage regulator makes the MP4088 start up quickly without a perceptible delay. The power de-rating at high temperatures makes the system flicker-free when the ambient temperature is high.

Full protections features include VCC under-voltage lockout (UVLO), over-voltage protection (OVP), and short-circuit protection (SCP). All of these features make the MP4088 an ideal solution for simple, offline, and non-isolated TRIAC dimmable LED lighting applications.

The MP4088 is available in TSOT23-5, SOIC8-7A, and SOIC-8 EP packages.

### FEATURES

- Excellent TRIAC Dimming Performance
- Lowest BOM Cost
- Constant Current LED Driver
- Integrated 500V MOSFET
- Internal HV Fast Start-Up
- Single Winding Inductor
- High Power Factor (>0.7)
- Good LED Current Accuracy
- Supports Buck and Buck-Boost Topology
- LED Current Foldback at High Temperature
- Thermal Shutdown (Auto-Restart with Hysteresis)
- VCC Under-Voltage Lockout with Hysteresis (UVLO)
- Programmable Over-Voltage Protection (OVP)
- Output Short-Circuit Protection (SCP)
- Auto-Restart Function
- Available in TSOT23-5, SOIC8-7A, and SOIC-8 EP Packages

### APPLICATIONS

- 230VAC, Up to 10W LED Lighting
- Residential and Commercial Lighting
- TRIAC Dimmable LED Lighting, A19, GU10, PAR Lamps

All MPS parts are lead-free, halogen-free, and adhere to the RoHS directive. For MPS green status, please visit the MPS website under Quality Assurance. "MPS" and "The Future of Analog IC Technology" are registered trademarks of Monolithic Power Systems, Inc.

### TYPICAL APPLICATION (BUCK)

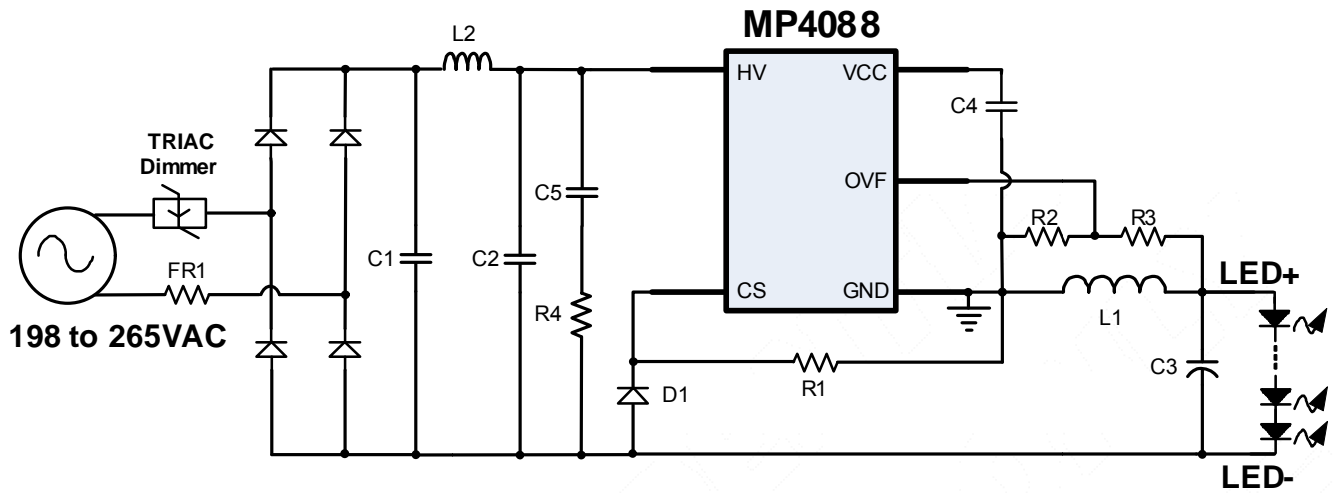

### TYPICAL APPLICATION (BUCK-BOOST)

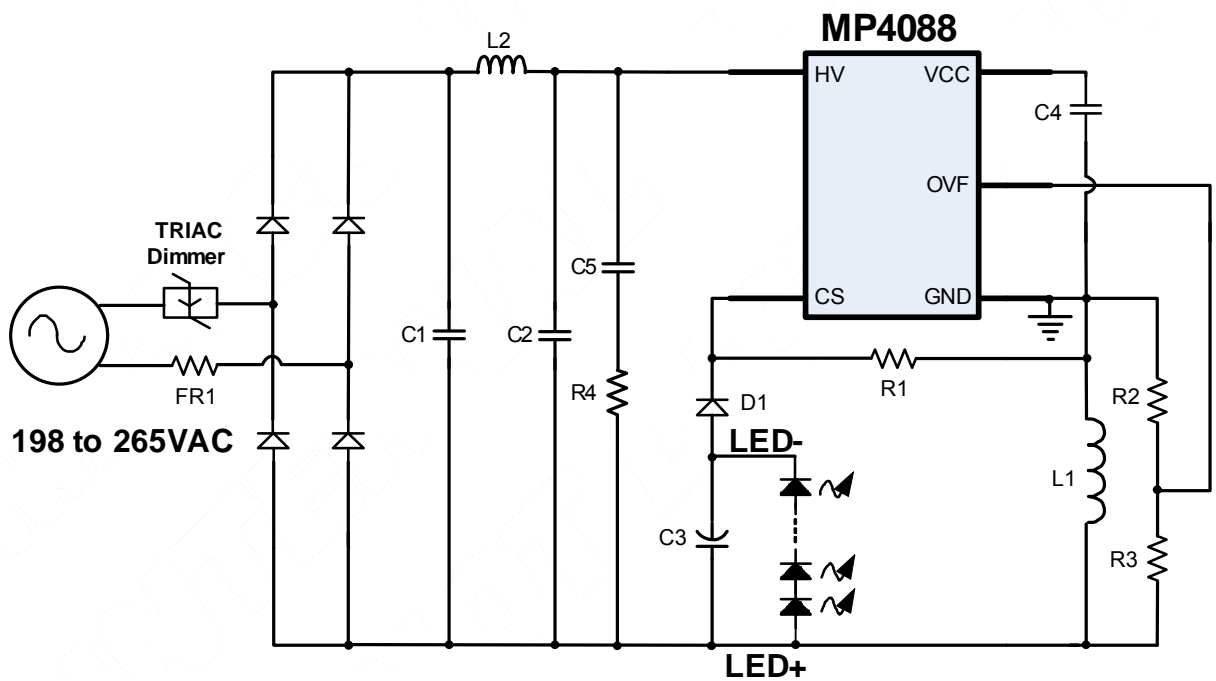

**ORDERING INFORMATION**

Part Number	Package	Top Marking
MP4088GJ*	TSOT23-5	See Below
MP4088GS**	SOIC8-7A	See Below
MP4088GN***	SOIC-8 EP	See Below

\* For Tape & Reel, add suffix -Z (e.g. MP4088GN-Z)

\*\* For Tape & Reel, add suffix -Z (e.g. MP4088GS-Z)

\*\*\* For Tape & Reel, add suffix -Z (e.g. MP4088GN-Z)

**TOP MARKING (MP4088GJ)**

| ARNY

ARN: Product code of MP4088GJ

Y: Year code

**TOP MARKING (MP4088GS)**

MP4088  
 LLLLLLLL  
 MPSYWW

MP4088: Product code of MP4088GS

LLLLLLLL: Lot number

MPS: MPS prefix

Y: Year code

WW: Week code

**TOP MARKING (MP4088GN)**

MP4088  
 LLLLLLLL  
 MPSYWW

MP4088: Product code of MP4088GN

LLLLLLLL: Lot number

MPS: MPS prefix

Y: Year code

WW: Week code

### PACKAGE REFERENCE

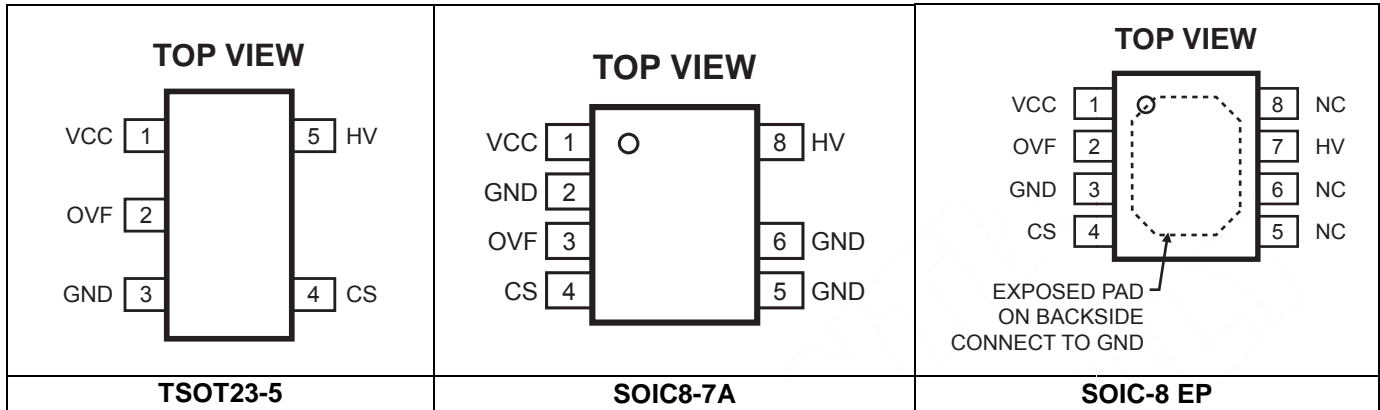

#### Absolute Maximum Ratings <sup>(1)</sup>

HV to CS.....	-0.3V to 500V
VCC, CS to GND .....	-0.3V to 6.5V
OVF to GND .....	-0.7V to 6.5V
Source current on OVF .....	4mA

#### Continuous power dissipation (T<sub>A</sub> = +25°C) <sup>(2)</sup>

TSOT23-5.....	1.25W
SOIC8-7A .....	1.6W
SOIC-8 EP.....	2.6W

Lead temperature .....	260°C
Storage temperature.....	-60°C to +150°C
ESD capability human body mode .....	2.0kV
CDM ESD capability	

TSOT23-5.....	1.5kV
SOIC8-7A/SOIC-8 EP.....	2kV

#### Recommended Operating Conditions <sup>(3)</sup>

Operating VCC range .....	4.5V to 5V
---------------------------	------------

#### Thermal Resistance <sup>(4)</sup>

	$\theta_{JA}$	$\theta_{JC}$
TSOT23-5 .....	100	55
SOIC8-7A.....	76	35
SOIC-8 EP .....	48	10

#### NOTES:

- 1) Exceeding these ratings may damage the device.
- 2) The maximum allowable power dissipation is a function of the maximum junction temperature T<sub>J</sub> (MAX), the junction-to-ambient thermal resistance  $\theta_{JA}$ , and the ambient temperature T<sub>A</sub>. The maximum allowable continuous power dissipation at any ambient temperature is calculated by P<sub>D</sub> (MAX) = (T<sub>J</sub> (MAX)-T<sub>A</sub>)/ $\theta_{JA}$ . Exceeding the maximum allowable power dissipation produces an excessive die temperature, causing the regulator to go into thermal shutdown. Internal thermal shutdown circuitry protects the device from permanent damage.
- 3) The device is not guaranteed to function outside of its operating conditions.
- 4) Measured on JESD51-7, 4-layer PCB.

## ELECTRICAL CHARACTERISTICS

Typical values are  $V_{CC} = 5V$ ,  $T_J = 25^\circ C$ , unless otherwise noted.

Minimum and maximum values are  $V_{CC} = 5V$ ,  $T_J = -40^\circ C$  to  $+125^\circ C$ , unless otherwise noted, guaranteed by characterization.

Parameter	Symbol	Condition	Min	Typ	Max	Units
<b>Start-Up Current Source (HV)</b>						
Internal regulator supply current	$I_{REGULATOR}$	$V_{CC} = 0V$ , $V_{HV} = 100V$	3.8	5	6.1	mA
Leakage current from HV	$I_{HV\_LKG}$	$V_{CC} = 5V$ , $V_{HV} = 400V$		14	22	$\mu A$
<b>Supply Voltage Management (VCC)</b>						
VCC upper threshold for internal regulator turn-off	$V_{CC\_OFF}$	VCC rising edge	4	4.35	4.7	V
VCC normal level	$V_{CC\_NOR}$	Normal operation		4.25		V
VCC lower threshold for internal regulator turn-on	$V_{CC\_ON}$	VCC falling edge	3.8	4.1	4.45	V
VCC hysteresis between regulator on/off	$V_{CC\_OFF-ON}$		0.12	0.21	0.3	V
VCC lower threshold for IC shutdown	$V_{CC\_STOP}$	VCC falling edge	3.0	3.4	3.8	V
VCC hysteresis between regulator off/IC shutdown	$V_{CC\_OFF-STOP}$		0.5	0.95	1.4	V
VCC lower threshold where protection phase ends	$V_{CC\_PRO}$	VCC falling edge	1.90	2.35	2.80	V
Internal IC consumption	$I_{CC}$	$V_{CC} = 4.3V$ , $f_{sw} = 33kHz$ , duty = 84%		350	400	$\mu A$
Internal IC consumption, latch-off phase	$I_{CC\_LATCH}$	$V_{CC} = 5V$		18	32	$\mu A$
<b>Internal MOSFET (HV to CS)</b>						
Breakdown voltage	$V_{BR}$	$I_{HV} = 80\mu A$	500			V
On-state resistance	$R_{DS(ON)}$	$I_{HV} = 10mA$ , $T_J = 25^\circ C$		8.5	12	$\Omega$
		$V_{CC} = V_{CC\_STOP} + 50mV$ , $I_{HV} = 10mA$ , $T_J = 25^\circ C$		8.5	12	$\Omega$
<b>Current Sampling Management (CS)</b>						
Peak current limit at normal operation	$V_{CS\_LIMIT}$		0.40	0.46	0.52	V
Leading edge blanking	$t_{LEB}$			200		ns
Feedback threshold to turn on MOSFET	$V_{REF}$		0.186	0.195	0.204	V
Minimum off-time limitation at normal operation	$t_{OFF\_MIN}$		7.1	9.3	11.8	$\mu s$
Maximum on-time limitation	$t_{ON\_MAX}$		3.3	4.5	6	$\mu s$
Ratio of $t_{ON\_MAX}/t_{OFF\_MIN}$	$\sigma$		0.42	0.48	0.58	

**ELECTRICAL CHARACTERISTICS *(continued)***

Typical values are  $V_{CC} = 5V$ ,  $T_J = 25^{\circ}C$ , unless otherwise noted.

Minimum and maximum values are at  $V_{CC} = 5V$ ,  $T_J = -40^{\circ}C$  to  $+125^{\circ}C$ , unless otherwise noted, guaranteed by characterization.

Parameter	Symbol	Condition	Min	Typ	Max	Units
<b>Protection Input (OVF)</b>						
Threshold to trigger OVP	$V_{OVP}$		1.85	2.0	2.15	V
Time constraint on OVP comparator	$t_{OVP}$			21	32	$\mu s$
<b>Thermal Protection</b>						
Power de-rating threshold <sup>(5)</sup>	$T_{START}$			145		$^{\circ}C$
Thermal shutdown threshold <sup>(5)</sup>	$T_{SD}$			160		$^{\circ}C$
Thermal shutdown recovery hysteresis <sup>(5)</sup>	$T_{HYS}$			50		$^{\circ}C$

**NOTE:**

5) Guaranteed by characterization.

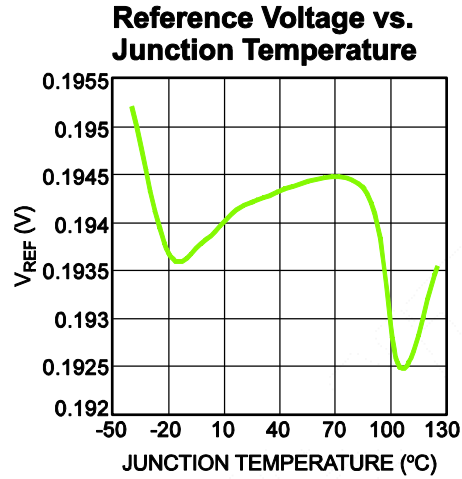
**TYPICAL CHARACTERISTICS**

## TYPICAL PERFORMANCE CHARACTERISTICS

Performance waveforms are tested on the evaluation board of the Design Example section.  
 $V_{IN} = 230V_{AC}$ ,  $V_{OUT} = 50V$ ,  $I_{LED} = 160mA$ ,  $T_A = 25^{\circ}C$ , unless otherwise noted.

### Line Regulation

$V_{IN}=(198-265)V_{AC}/50Hz$ , Full Load

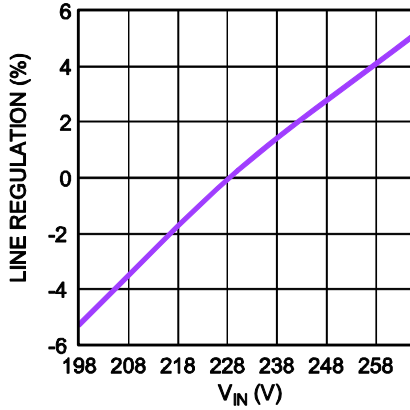

### Load Regulation

$V_{IN}=(198-265)V_{AC}/50Hz$

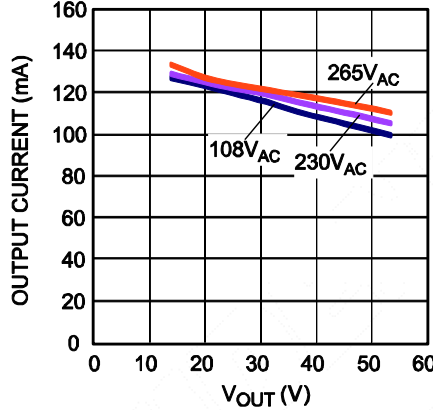

### Efficiency

$V_{IN}=(198-265)V_{AC}/50Hz$ , Full Load

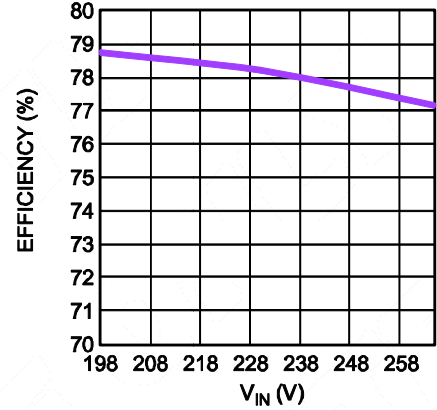

### PF vs. $V_{IN}$

$V_{IN}=(198-265)V_{AC}/50Hz$ , Full Load

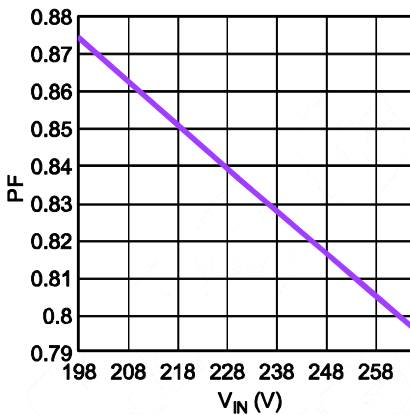

### THD vs. $V_{IN}$

$V_{IN}=(198-265)V_{AC}/50Hz$ , Full Load

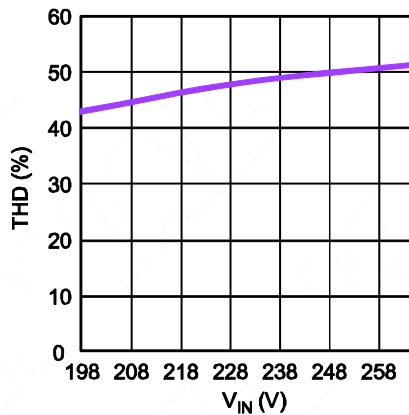

### Dimming Curve

$V_{IN}=230V_{AC}/50Hz$ , Full Load,  
with Different Dimmers

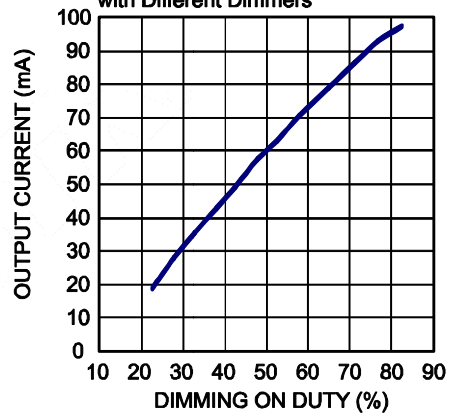

### Conducted EMI, L-Line

$V_{IN}=230V_{AC}$ , RBW=9kHz, MT=20ms

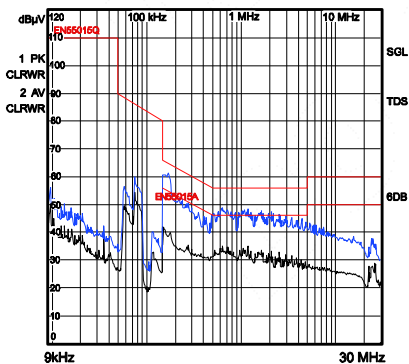

### Conducted EMI, N-Line

$V_{IN}=230V_{AC}$ , RBW=9kHz, MT=20ms

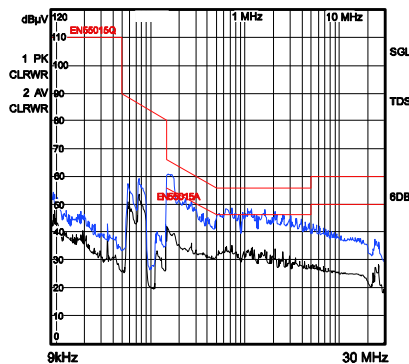

### CDN Test

$V_{IN}=230V_{AC}$ , RBW=120kHz, MT=1ms

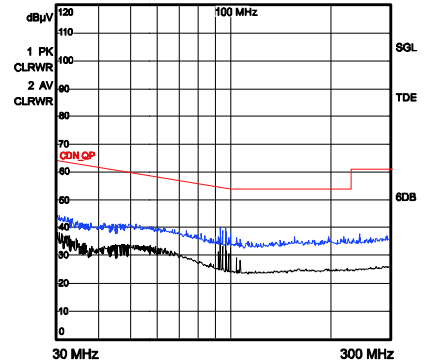



**TYPICAL PERFORMANCE CHARACTERISTICS (continued)**

Performance waveforms are tested on the evaluation board of the Design Example section.  
 $V_{IN} = 230V_{AC}$ ,  $V_{OUT} = 50V$ ,  $I_{LED} = 160mA$ ,  $T_A = 25^{\circ}C$ , unless otherwise noted.

**Steady State**

$V_{IN}=230V_{AC}/50Hz$ , Full Load

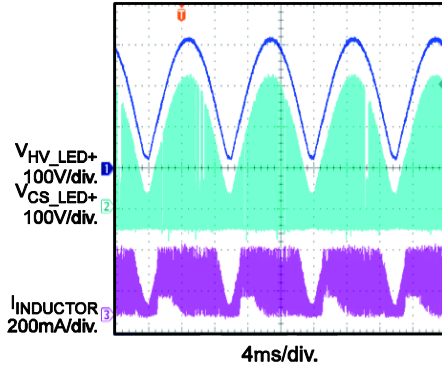

**Steady State**

$V_{IN}=230V_{AC}/50Hz$ , Full Load

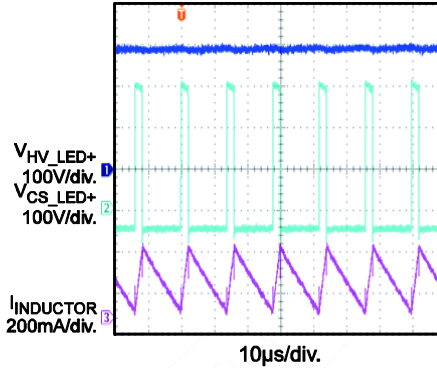

**Steady State**

$V_{IN}=230V_{AC}/50Hz$ , Full Load

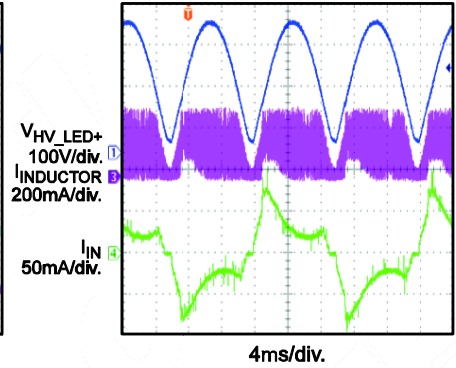

**$V_{IN}$  Start-Up**

$V_{IN}=230V_{AC}/50Hz$ , Full Load

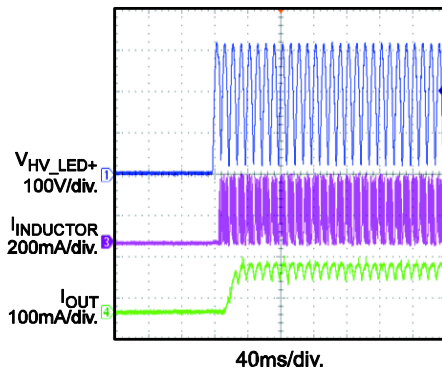

**$V_{IN}$  Shutdown**

$V_{IN}=230V_{AC}/50Hz$ , Full Load

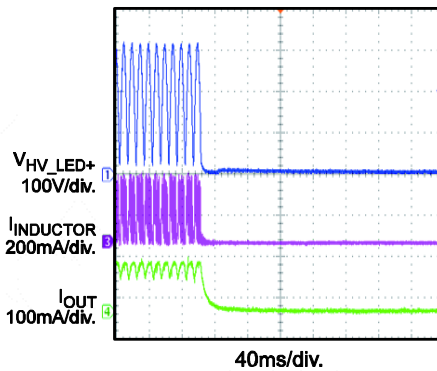

**Dimming Performance**

Max Dmimg On Phase with Leading-Edge Dimmer  
 $V_{IN}=230V_{AC}/50Hz$

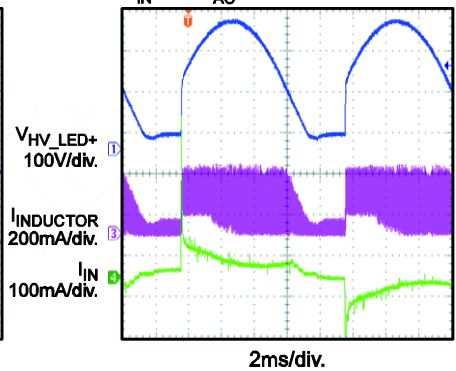

**Dimming Performance**

Min Dmimg On Phase with Leading-Edge Dimmer  
 $V_{IN}=230V_{AC}/50Hz$

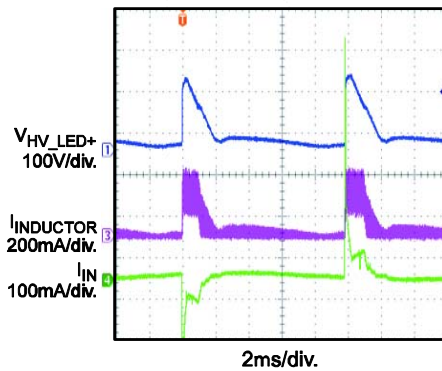

**Dimming Performance**

Max Dmimg On Phase with Trailing-Edge Dimmer  
 $V_{IN}=230V_{AC}/50Hz$

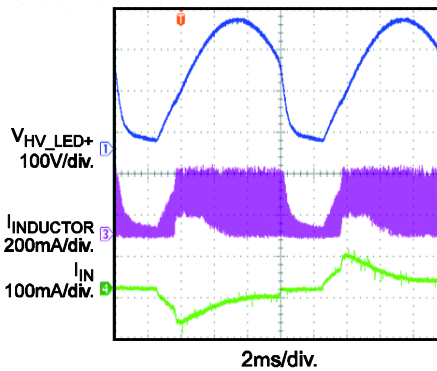

**Dimming Performance**

Min Dmimg On Phase with Trailing-Edge Dimmer  
 $V_{IN}=230V_{AC}/50Hz$

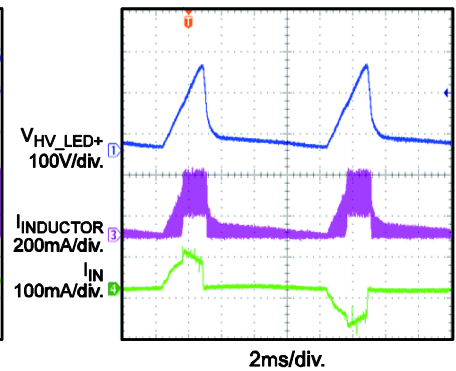

**TYPICAL PERFORMANCE CHARACTERISTICS (continued)**

Performance waveforms are tested on the evaluation board of the Design Example section.  
 $V_{IN} = 230V_{AC}$ ,  $V_{OUT} = 50V$ ,  $I_{LED} = 160mA$ ,  $T_A = 25^{\circ}C$ , unless otherwise noted.

**SCP**

LED+ Short to LED- and then Recovery  
 $V_{IN}=230V_{AC}/50Hz$

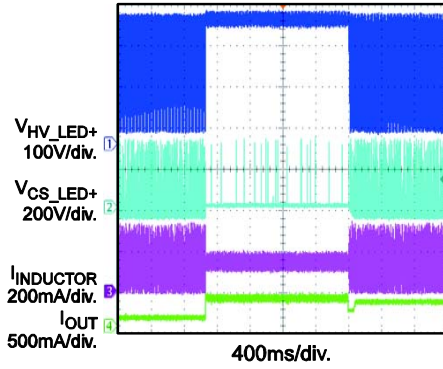

**OVP**

LED Load Open, then Recovery  
 $V_{IN}=230V_{AC}/50Hz$

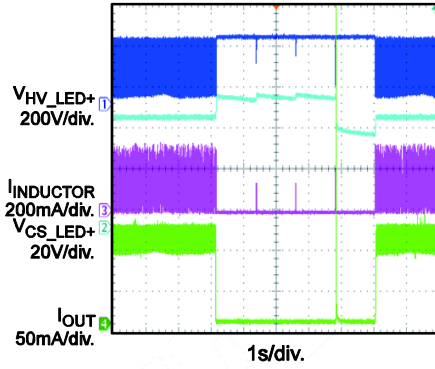

**Output Current Thermal Foldback Curve**

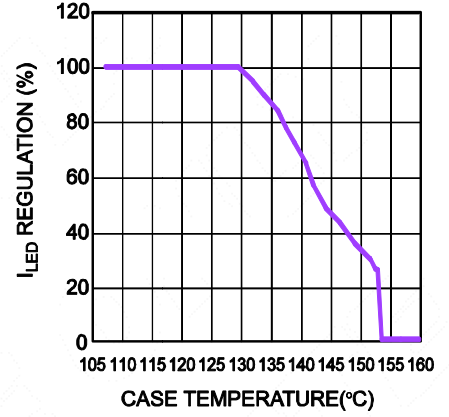

**PIN FUNCTIONS**

Pin #			Name	Description
TSOT23-5	SOIC8-7A	SOIC-8 EP		
1	1	1	VCC	<b>Power supply.</b> VCC is the supply power for all of the control circuits. Connect VCC to an external bulk capacitor.
3	2, 5, 6	3	GND	<b>Ground.</b> GND is the virtual ground of the IC.
2	3	2	OVF	<b>Output voltage feedback.</b> The over-voltage condition is detected on OVF. When the voltage on OVF exceeds $V_{OVP}$ after a blanking time, OVP is triggered, and the chip shuts down.
4	4	4	CS	<b>Current sense of the internal power MOSFET.</b> Connect a resistor from CS to GND to sense the current through the inductor. When the voltage on CS exceeds $V_{CS\_LIMIT}$ , the internal MOSFET is turned off. If the start-up time exceeds the maximum on-time, the internal MOSFET is turned off, even though the voltage on CS has not reached $V_{CS\_LIMIT}$ .
5	8	7	HV	<b>High-voltage input of the internal power MOSFET.</b> HV is also the input of the internal high-voltage current source.
--	--	5, 6, 8	NC	<b>Not connected.</b>
			Exposed Pad	<b>The exposed pad should be connected to the GND plane for optimal thermal performance.</b>

**BLOCK DIAGRAM**

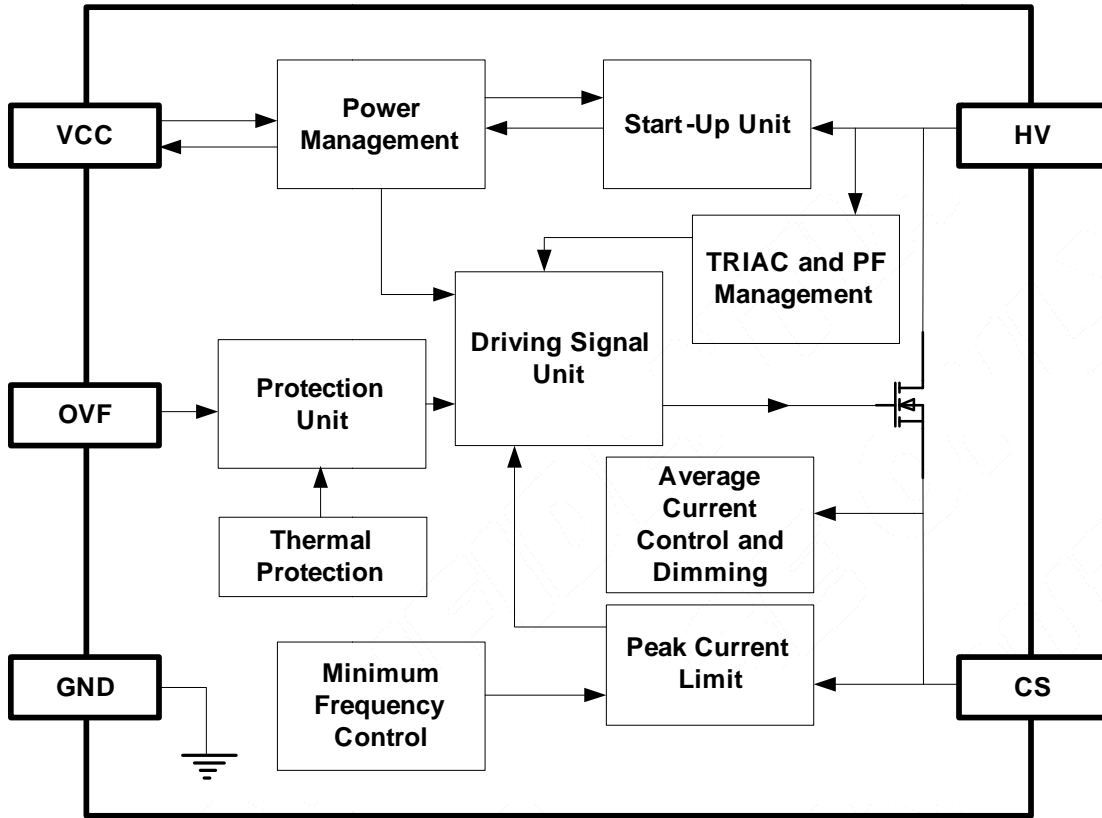

Figure 1: Functional Block Diagram

## OPERATION

The MP4088 is a highly integrated, cost-effective, TRIAC dimmable LED driver. The MP4088 requires only a minimal number of external components, making it a competitive IC in high-line (230VAC) input and non-isolated applications, especially for small form-factor applications. Hybrid operation mode achieves both good dimming performance and accurate output current. The power factor exceeds 0.7 in most applications to eliminate harmonic pollution on the AC line. The integrated high-voltage regulator enables fast start-up without any perceptible delay. The power de-rating function at high temperatures protects the IC from thermal damage.

### Hybrid Operation Mode

To achieve smooth TRIAC dimming, the MP4088 implements proprietary hybrid operation mode, in which the IC self-adjusts the internal switching mode between CCM and DCM during different times of the AC cycle. The hybrid operation mode actively maintains the latching current and holding current of the leading edge TRIAC to enable a good power factor.

The hybrid operation mode also achieves a small dimming duty condition. The IC works in CCM during the entire dimming on time when the dimmer is set to a small dimming duty. A higher and smoother input current can achieve excellent dimming performance.

### Power Supply

The IC is self-supplied by the internal high-voltage regulator, which is drawn from HV. The IC begins switching, and the internal high-voltage regulator turns off once the voltage on VCC reaches  $V_{CC\_OFF}$ . When the voltage on VCC falls below  $V_{CC\_ON}$ , the internal high-voltage regulator turns on again to charge the external VCC capacitor. VCC is regulated at  $V_{CC\_NOR}$  for normal operation.

In TRIAC dimming applications, the internal high-voltage regulator only works when the dimmer is on. To maintain a sufficient driving capacity, a capacitor of 10 $\mu$ F or larger is recommended for VCC. If a single VCC capacitor cannot provide enough power supply for the chip, an external charging circuit is recommended (see Figure 2).

When VCC drops below  $V_{CC\_STOP}$ , the IC stops working, and the internal high-voltage regulator recharges the VCC capacitor.

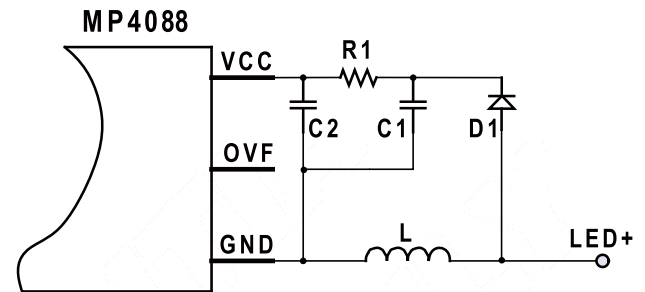
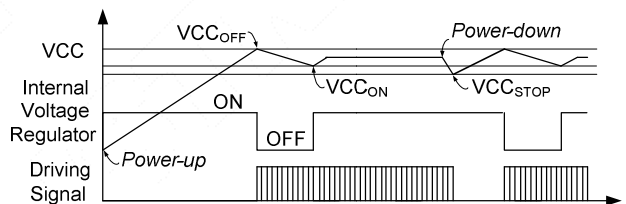

**Figure 2: VCC Charging Circuit**

When a fault conditions occurs, such as OVP or OTP, the MP4088 stops working, and an internal current source ( $I_{CC\_LATCH}$ ) discharges the VCC capacitor. After VCC drops below  $V_{CC\_PRO}$ , the internal high-voltage regulator recharges the VCC capacitor. The restart time can be calculated with Equation (1):

$$t_{RESTART} = C_{VCC} \times \frac{V_{CC\_NOR} - V_{CC\_PRO}}{I_{CC\_LATCH}} + C_{VCC} \times \frac{V_{CC\_OFF} - V_{CC\_PRO}}{I_{REGULATOR}} \quad (1)$$

Figure 3 shows the typical waveform with VCC under-voltage lockout.



**Figure 3: VCC Under-Voltage Lockout (UVLO)**

### Constant Current Operation

The MP4088 is a highly integrated driver. The internal feedback logic responds to the internal sample and hold circuit to achieve constant output-current regulation. The voltage of the internal sampling capacitor ( $V_{FB}$ ) is compared to the internal reference ( $V_{REF}$ ). When the sampling capacitor voltage ( $V_{FB}$ ) falls below the reference voltage, indicating an insufficient output current, the integrated MOSFET is turned on. The on period is determined by the peak current limit. After the on period elapses, the integrated MOSFET turns off (see Figure 4).

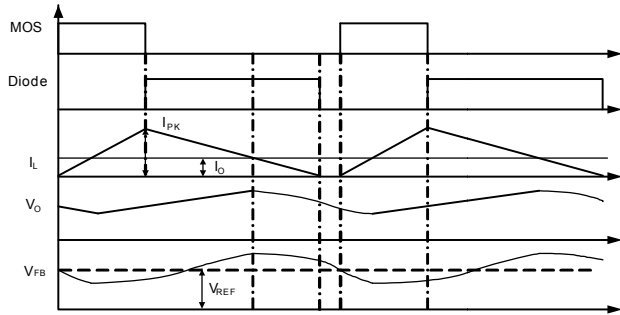
**Figure 4:  $V_{FB}$  vs.  $I_{OUT}$** 

The inductor's average current can be regulated by monitoring the internal sampling capacitor voltage. The inductor average current can be calculated with Equation (2):

$$I_{L\_AVG} = \frac{V_{REF}}{R_S} \quad (2)$$

The peak inductor current can be calculated with Equation (3):

$$I_{PK} = \frac{V_{CS\_LIMIT}}{R_S} \quad (3)$$

Where  $R_S$  is the sense resistor connected from CS to GND.

### Minimum Operating Frequency Limit

The MP4088 incorporates a minimum operating frequency (22kHz) to eliminate audible noise. When the operating frequency is less than 22kHz, the internal peak current regulator decreases the peak current value to keep the operating frequency constant at about 22kHz.

### Minimum Off-Time Limit

The MP4088 implements a minimum off-time limit. During normal operation, the minimum off-time limit is 9.3 $\mu$ s. In the start-up period, the minimum off-time limit is shortened gradually from 3.5 times to 1.2 times the normal minimum off-time (see Figure 5). Each minimum off-time limit lasts for 32 switching cycles. This process ensures a soft-start function of the IC to safely start up the part.

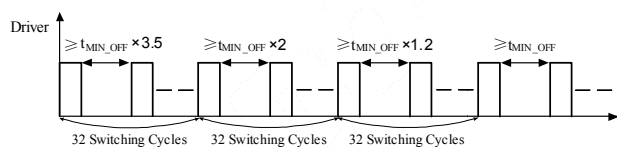
**Figure 5:  $t_{OFF\_MIN}$  at Start-Up**

### Thermal Protection

To protect the IC and the system from thermal damage, the MP4088 reduces the reference to decrease the output current. This limits the temperature rising speed of the IC when the junction temperature exceeds 145°C. The output current drops to around 20% when the IC temperature rises to 160°C. Once the junction temperature exceeds 160°C, the MP4088 shuts down the switching cycle. Once the junction temperature drops below 110°C, the power supply resumes operation. During thermal shutdown, VCC is discharged to VCC<sub>PRO</sub>, and then it is recharged by the internal high-voltage regulator.

### Over-Voltage Protection (OVP)

If  $V_{OVF}$  is higher than  $V_{OVP}$  when the MOSFET turns off, the MP4088 stops working and a restart cycle begins. When OVP occurs, the chip works in hiccup mode. The MP4088 monitors the OVF voltage continuously, and VCC discharges and recharges repeatedly. The MP4088 resumes operation once the fault is removed.

### Short-Circuit Protection (SCP)

When an LED short circuit occurs, the switching off-time is extended. Due to the minimum operating frequency limit, the IC reduces the switching frequency automatically and achieves a closed loop control. The output power at this condition is limited at a safe range. The MP4088 resumes normal operation once the short circuit is released.

### Leading Edge Blanking (LEB)

Internal leading edge blanking (LEB) is employed to prevent a switching pulse from terminating prematurely due to parasitic capacitance discharging when the MOSFET turns on. During the blanking time, the path from CS to the current comparator input is blocked. Figure 6 shows the leading-edge blanking time.

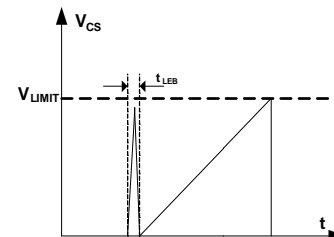
**Figure 6: Leading Edge Blanking (LEB)**

## APPLICATION INFORMATION

### Selecting the Inductor

The MP4088 has a minimum off-time limit. The inductor current ripple at CCM is determined by the inductor value and the minimum off-time limit. The current ripple is limited to 80% to achieve a tradeoff between the power factor and the dimming performance. The inductance value can be calculated with Equation (4):

$$L = \frac{V_{OUT} \times t_{OFF\_MIN}}{0.8 \times I_{PEAK}} \quad (4)$$

If the inductance value is too large, then the switching frequency is low and the EMI performance is good. However, the TRIAC dimming performance is poor in this condition. If the inductance value is too small, the TRIAC dimming performance is good, but the system may work in an open-loop condition, making the current consistency poor. Therefore, a tradeoff must be made.

### Freewheeling Diode

The diode should have a maximum reverse-voltage rating greater than the maximum input voltage. The current rating of the diode is determined by the output current, which should be larger than 1.5 to 2 times the output current.

Slow diodes cause excessive and unwanted leading edge current spikes during start-up. A long reverse-recovery time of the freewheeling diode can affect efficiency and circuit operation as well. An ultrafast diode ( $t_r < 75\text{ns}$ ), such as WUGC10JH or ES1G, is recommended.

### Over-Voltage Protection (OVP) Point Set

A feedback resistor is used to detect an over-voltage condition. Figure 7 shows the connection of the feedback resistor.

The MP4088 employs an over-voltage protection (OVP). When OVP is triggered, the maximum output voltage can be calculated with Equation (5):

$$V_{OUT\_OVP} = V_{OVP} \cdot \frac{R2 + R3}{R2} - V_D \quad (5)$$

Where  $V_D$  is the freewheeling diode forward voltage drop.

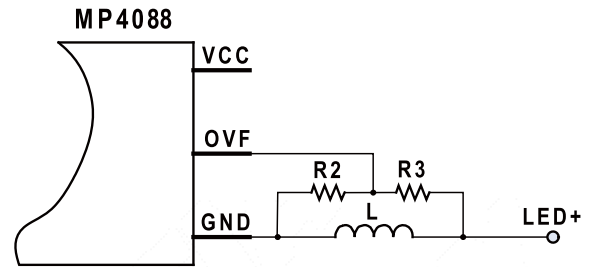

**Figure 7: Feedback Resistor Connection**

The upper feedback resistor (R3) should be larger than 100kΩ to avoid an efficiency reduction in the application. A 1% tolerance type is recommended to achieve accurate protection.

### Dummy Load

The dummy load is used to consume the power transferred to the output capacitor when OVP occurs. The IC works in hiccup mode without any power consumption.

Normally, a dummy load less than 1mA is recommended. This does not deteriorate the system efficiency but can guarantee normal over-voltage protection.

### Surge

Place an appropriate RCD snubber beside the diode rectifier bridge for optimal surge performance. For most applications, a 1μF/400V electrolytic capacitor with a 1000V diode is recommended. The resistor can be as large as 1MΩ to reduce power loss during normal operation.

### PCB Layout Guidelines

Efficient PCB layout is critical for stable operation, good EMI, and good thermal performance, especially in very small LED applications. For best results, refer to Figure 8 and follow the guidelines below:

1. Keep the loop formed between the MP4088, the inductor, the freewheeling diode, and the output capacitor as small as possible for better EMI.
2. Place the AC input far away from the switching nodes to minimize the noise coupling that may bypass the input filter.
3. Place the VCC capacitor as close to VCC and GND as possible.
4. Place the feedback resistor as close to OVF as possible to minimize the feedback sampling loop and minimize the noise coupling route.
5. If using SOIC-8 EP package IC, remember to connect the exposed pad to GND plane.

### Design Example

Table 1 is a design example following the application guidelines based on the following specifications:

**Table 1: Design Example**

$V_{IN}$	198VAC to 265VAC
$V_{OUT}$	55V
$I_{OUT}$	100mA

Figure 9 shows the detailed application schematic. This circuit is used for the typical performance and circuit waveforms. For more device applications, please refer to the related evaluation board datasheets.

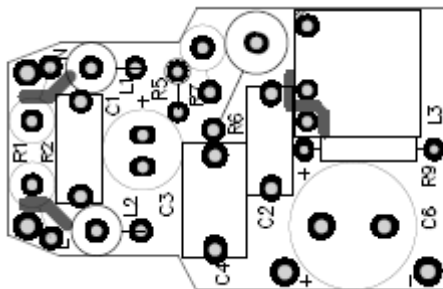

Top Layer

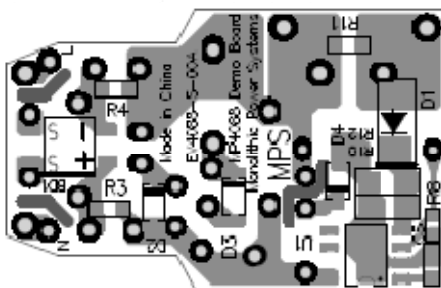

Bottom Layer

**Figure 8: Recommended PCB Layout**



## TYPICAL APPLICATION CIRCUITS

Figure 9 shows a typical application example of a 55V, 100mA, non-isolated, buck-boost topology LED driver with the MP4088.

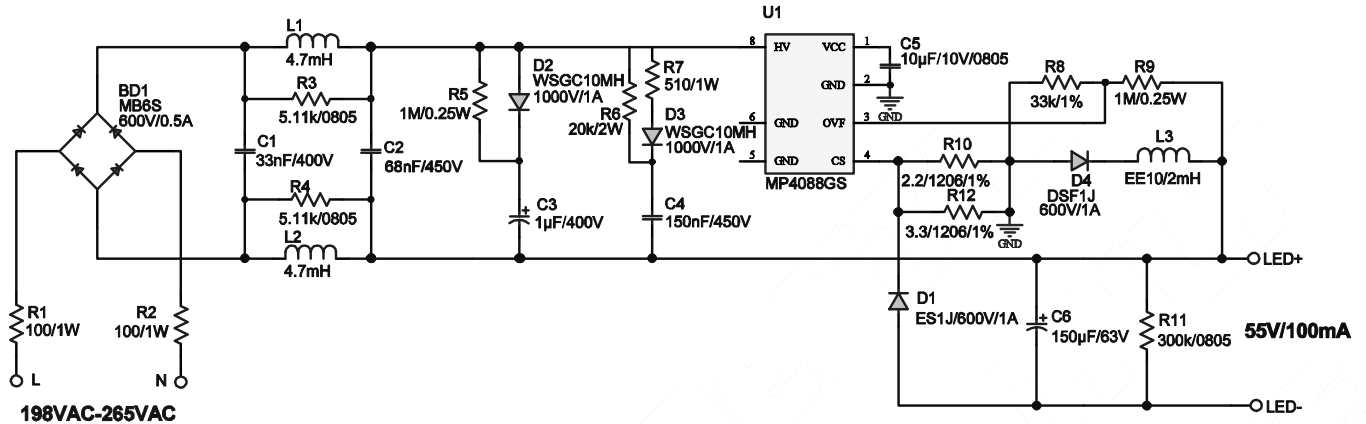

**Figure 9: Typical Buck-Boost Converter Application**

# PACKAGE INFORMATION

## TSOT23-5

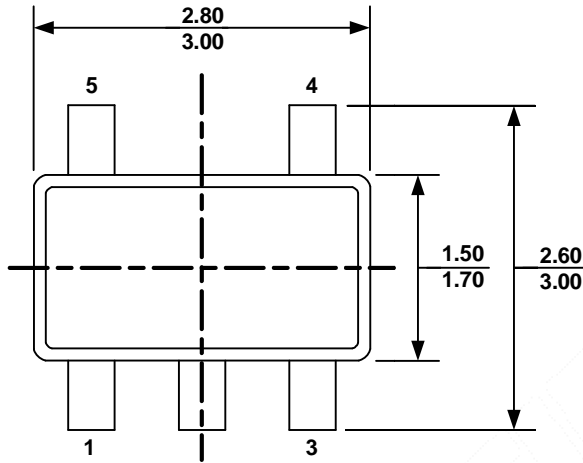

**TOP VIEW**

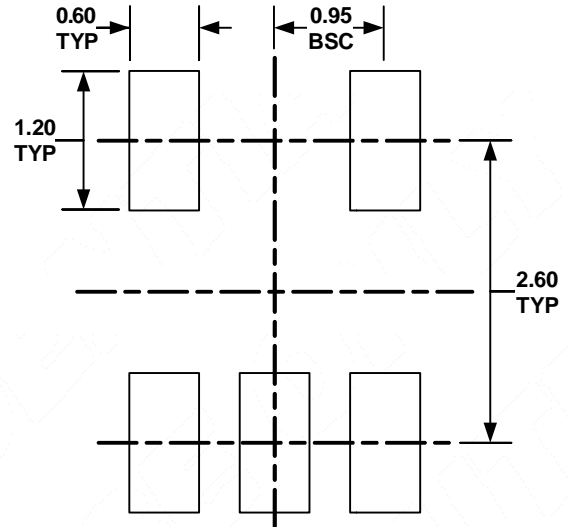

**RECOMMENDED LAND PATTERN**

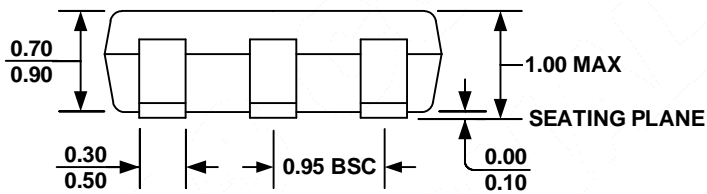

**FRONT VIEW**

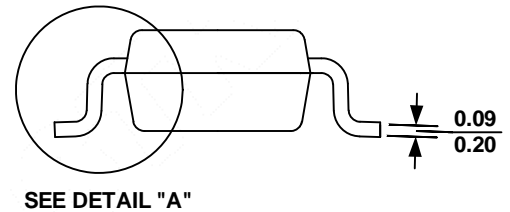

**SIDE VIEW**

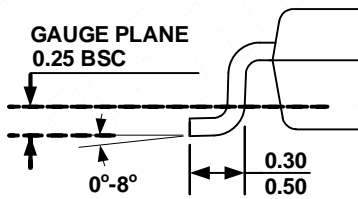

**DETAIL "A"**

**NOTE:**

- 1) ALL DIMENSIONS ARE IN MILLIMETERS
- 2) PACKAGE LENGTH DOES NOT INCLUDE MOLD FLASH, PROTRUSION OR GATE BURR.
- 3) PACKAGE WIDTH DOES NOT INCLUDE INTERLEAD FLASH OR PROTRUSION.
- 4) LEAD COPLANARITY (BOTTOM OF LEADS AFTER FORMING) SHALL BE 0.10 MILLIMETERS MAX
- 5) DRAWING CONFORMS TO JEDEC MO-193, VARIATION AA
- 6) DRAWING IS NOT TO SCALE

PACKAGE INFORMATION (continued)

SOIC8-7A

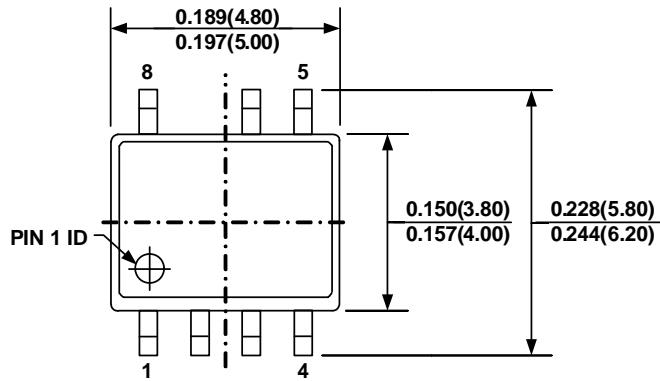

TOP VIEW

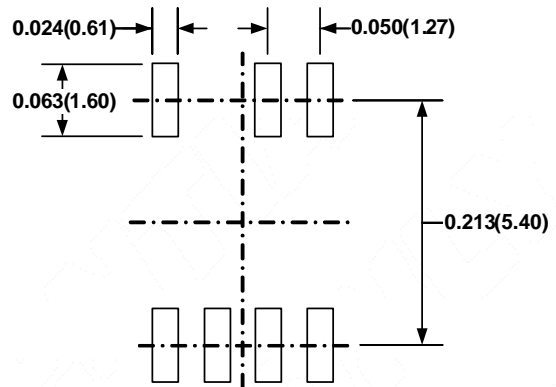

RECOMMENDED LAND PATTERN

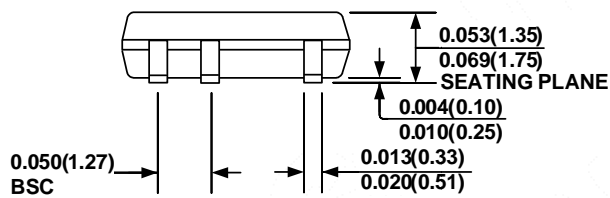

FRONT VIEW

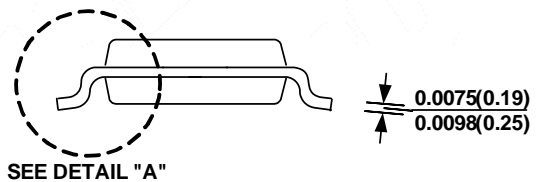

SIDE VIEW

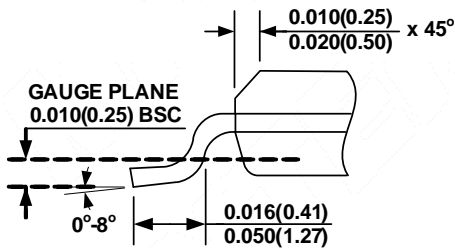

DETAIL "A"

NOTE:

- 1) CONTROL DIMENSION IS IN INCHES DIMENSION IN BRACKET IS IN MILLIMETERS
- 2) PACKAGE LENGTH DOES NOT INCLUDE MOLD FLASH, PROTRUSIONS OR GATE BURRS
- 3) PACKAGE WIDTH DOES NOT INCLUDE INTERLEAD FLASH OR PROTRUSIONS.
- 4) LEAD COPLANARITY (BOTTOM OF LEADS AFTER FORMING) SHALL BE 0.004" INCHES MAX.
- 5) JEDEC REFERENCE IS MS-012
- 6) DRAWING IS NOT TO SCALE

PACKAGE INFORMATION (continued)

SOIC-8 EP

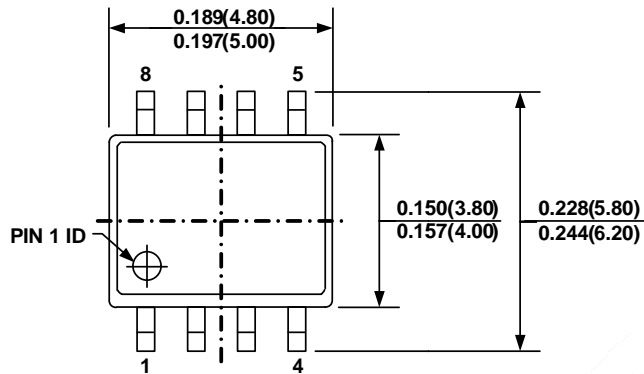

TOP VIEW

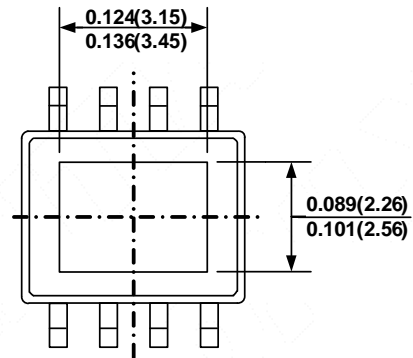

BOTTOM VIEW

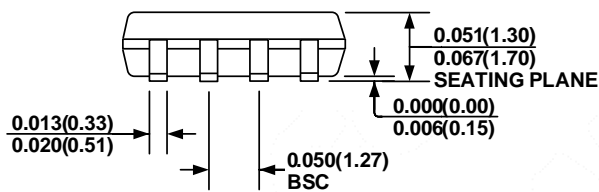

FRONT VIEW

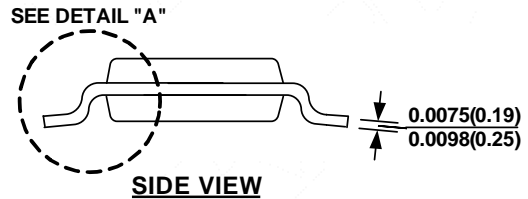

SIDE VIEW

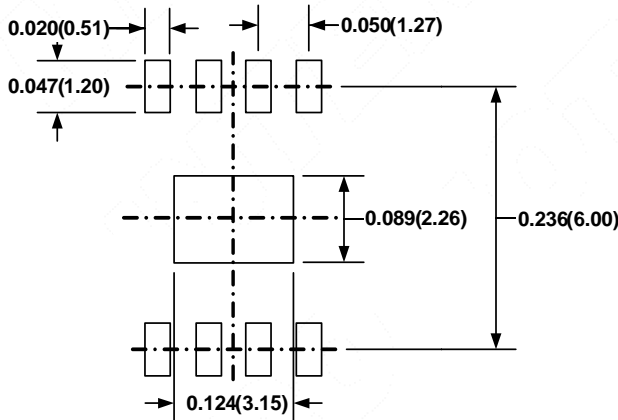

RECOMMENDED LAND PATTERN

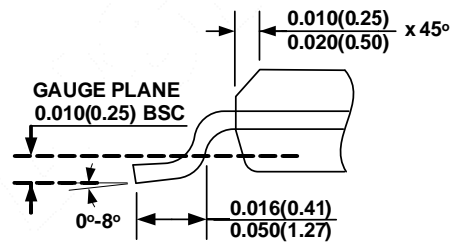

DETAIL "A"

NOTE:

- 1) CONTROL DIMENSION IS IN INCHES DIMENSION IN BRACKET IS IN MILLIMETERS
- 2) PACKAGE LENGTH DOES NOT INCLUDE MOLD FLASH, PROTRUSIONS OR GATE BURRS
- 3) PACKAGE WIDTH DOES NOT INCLUDE INTERLEAD FLASH OR PROTRUSIONS.
- 4) LEAD COPLANARITY(BOTTOM OF LEADS AFTER FORMING) SHALL BE 0.004" INCHES MAX.
- 5) DRAWING CONFORMS TO JEDEC MS012, VARIATION BA.
- 6) DRAWING IS NOT TO SCALE

**NOTICE:** The information in this document is subject to change without notice. Users should warrant and guarantee that third party Intellectual Property rights are not infringed upon when integrating MPS products into any application. MPS will not assume any legal responsibility for any said applications.



Компания «ЭлектроПласт» предлагает заключение долгосрочных отношений при поставках импортных электронных компонентов на взаимовыгодных условиях!

Наши преимущества:

- Оперативные поставки широкого спектра электронных компонентов отечественного и импортного производства напрямую от производителей и с крупнейших мировых складов;
- Поставка более 17-ти миллионов наименований электронных компонентов;
- Поставка сложных, дефицитных, либо снятых с производства позиций;
- Оперативные сроки поставки под заказ (от 5 рабочих дней);
- Экспресс доставка в любую точку России;
- Техническая поддержка проекта, помощь в подборе аналогов, поставка прототипов;
- Система менеджмента качества сертифицирована по Международному стандарту ISO 9001;
- Лицензия ФСБ на осуществление работ с использованием сведений, составляющих государственную тайну;
- Поставка специализированных компонентов (Xilinx, Altera, Analog Devices, Intersil, Interpoint, Microsemi, Aeroflex, Peregrine, Syfer, Eurofarad, Texas Instrument, Miteq, Cobham, E2V, MA-COM, Hittite, Mini-Circuits, General Dynamics и др.);

Помимо этого, одним из направлений компании «ЭлектроПласт» является направление «Источники питания». Мы предлагаем Вам помощь Конструкторского отдела:

- Подбор оптимального решения, техническое обоснование при выборе компонента;
- Подбор аналогов;
- Консультации по применению компонента;
- Поставка образцов и прототипов;
- Техническая поддержка проекта;
- Защита от снятия компонента с производства.



#### Как с нами связаться

**Телефон:** 8 (812) 309 58 32 (многоканальный)

**Факс:** 8 (812) 320-02-42

**Электронная почта:** [org@eplast1.ru](mailto:org@eplast1.ru)

**Адрес:** 198099, г. Санкт-Петербург, ул. Калинина, дом 2, корпус 4, литера А.