

SURFACE MOUNT ZENER DIODE

VOLTAGE RANGE 2.4 to 91 Volts POWER RATING 500 mWatts

FEATURES

- * Planar Die Construction
- * 500mW Power Dissipation
- * General Purpose, Medium Current
- * Ideally Suited for Automated Assembly Processes
- * ESD Rating of Class 3(> 16kV) per Human Body Model
- * MSL: Level 1
- * P/N suffix V means AEC-Q101 qualified, e.g:MMSZ5221BV
- * Halogen-free

MECHANICAL DATA

- * Case: Molded plastic
- * Epoxy: UL 94V-O rate flame retardant
- * Lead: MIL-STD-202E method 208C guaranteed
- * Mounting position: Any
- * Weight: 0.01 gram

MAXIMUM RATINGS AND ELECTRICAL CHARACTERISTICS

Ratings at 25 °C ambient temperature unless otherwise specified.

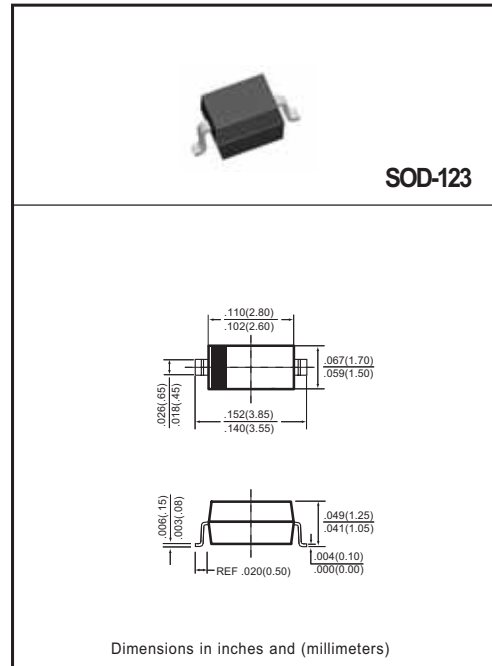

MAXIMUM RATINGS (@ TA = 25°C unless otherwise noted)

RATINGS	SYMBOL	VALUE	UNITS
Max. Steady State Power Dissipation @TA=25°C (Note 1)	PD	500	mW
Max. Operating Temperature Range	TJ	-65 to +150	°C
Storage Temperature Range	TSTG	-65 to +150	°C

ELECTRICAL CHARACTERISTICS (@ TA = 25°C unless otherwise noted)

CHARACTERISTICS	SYMBOL	MIN.	TYP.	MAX.	UNITS
Thermal Resistance Junction to Ambient (Note 1)	R θJA	-	-	350	°C/W
Max. Instantaneous Forward Voltage at IF= 10mA	VF	-	-	0.9	Volts

Note 1. Device mounted on ceramic PCB; 7.6mm x 9.4mm x 0.87mm with pad areas 25 mm².

2020-03/08
REV: G

ELECTRICAL CHARACTERISTICS (@TA=25°C unless otherwise specified)

TYPE	MARKING	Zener voltage Range (Note 1) Vz (V) @ IZT			Test current IZT (mA)	Maximum Zener impedance			Maximum Reverse leakage current	
		Nom	Min	Max		ZzT at IZT (Ω)	Zzk (Ω)	at Izk (mA)	IR (μA)	at VR (V)
		Volts	Volts	Volts						
MMSZ5221B	C1	2.4	2.28	2.52	20	30	1200	0.25	100	1.0
MMSZ5222B	C2	2.5	2.38	2.63	20	30	1250	0.25	100	1.0
MMSZ5223B	C3	2.7	2.57	2.84	20	30	1300	0.25	75	1.0
MMSZ5225B	C5	3.0	2.85	3.15	20	30	1600	0.25	50	1.0
MMSZ5226B	G1	3.3	3.14	3.47	20	28	1600	0.25	25	1.0
MMSZ5227B	G2	3.6	3.42	3.78	20	24	1700	0.25	15	1.0
MMSZ5228B	G3	3.9	3.71	4.10	20	23	1900	0.25	10	1.0
MMSZ5229B	G4	4.3	4.09	4.52	20	22	2000	0.25	5.0	1.0
MMSZ5230B	G5	4.7	4.47	4.94	20	19	1900	0.25	5.0	2.0
MMSZ5231B	E1	5.1	4.85	5.36	20	17	1600	0.25	5.0	2.0
MMSZ5232B	E2	5.6	5.32	5.88	20	11	1600	0.25	5.0	3.0
MMSZ5233B	E3	6.0	5.70	6.30	20	7	1600	0.25	5.0	3.5
MMSZ5234B	E4	6.2	5.89	6.51	20	7	1000	0.25	5.0	4.0
MMSZ5235B	E5	6.8	6.46	7.14	20	5	750	0.25	3.0	5.0
MMSZ5236B	F1	7.5	7.13	7.88	20	6	500	0.25	3.0	6.0
MMSZ5237B	F2	8.2	7.79	8.61	20	8	500	0.25	3.0	6.5
MMSZ5238B	F3	8.7	8.27	9.14	20	8	600	0.25	3.0	6.5
MMSZ5239B	F4	9.1	8.65	9.56	20	10	600	0.25	3.0	7.0
MMSZ5240B	F5	10	9.50	10.50	20	17	600	0.25	3.0	8.0
MMSZ5241B	H1	11	10.45	11.55	20	22	600	0.25	2.0	8.4
MMSZ5242B	H2	12	11.40	12.60	20	30	600	0.25	1.0	9.1
MMSZ5243B	H3	13	12.35	13.65	9.5	13	600	0.25	0.5	9.9
MMSZ5244B	H4	14	13.3	14.7	9.0	15	600	0.25	0.1	10
MMSZ5245B	H5	15	14.25	15.75	8.5	16	600	0.25	0.1	11
MMSZ5246B	J1	16	15.20	16.80	7.8	17	600	0.25	0.1	12
MMSZ5247B	J2	17	16.15	17.85	7.4	19	600	0.25	0.1	13
MMSZ5248B	J3	18	17.10	18.90	7.0	21	600	0.25	0.1	14
MMSZ5250B	J5	20	19.00	21.00	6.2	25	600	0.25	0.1	15
MMSZ5251B	K1	22	20.90	23.10	5.6	29	600	0.25	0.1	17
MMSZ5252B	K2	24	22.80	25.20	5.2	33	600	0.25	0.1	18
MMSZ5254B	K4	27	25.65	28.35	5.0	41	600	0.25	0.1	21
MMSZ5255B	K5	28	26.60	29.40	4.5	44	600	0.25	0.1	21
MMSZ5256B	M1	30	28.50	31.50	4.2	49	600	0.25	0.1	23
MMSZ5257B	M2	33	31.35	34.65	3.8	58	700	0.25	0.1	25
MMSZ5258B	M3	36	34.20	37.80	3.4	70	700	0.25	0.1	27
MMSZ5259B	M4	39	37.05	40.95	3.2	80	800	0.25	0.1	30
MMSZ5260B	M5	43	40.85	45.15	3.0	93	900	0.25	0.1	33
MMSZ5261B	N1	47	44.65	49.35	2.7	105	1000	0.25	0.1	36
MMSZ5262B	N2	51	48.45	53.55	2.5	125	1100	0.25	0.1	39
MMSZ5263B	N3	56	53.20	58.80	2.2	150	1300	0.25	0.1	43
MMSZ5264B	N4	60	57.00	63.00	2.1	170	1400	0.25	0.1	46
MMSZ5265B	N5	62	58.90	65.10	2.0	185	1400	0.25	0.1	47
MMSZ5266B	P1	68	64.60	71.40	1.8	230	1600	0.25	0.1	52
MMSZ5267B	P2	75	71.25	78.75	1.7	270	1700	0.25	0.1	56
MMSZ5268B	P3	82	77.90	86.10	1.5	330	2000	0.25	0.1	62
MMSZ5269B	P4	87	82.65	91.35	1.4	370	2200	0.25	0.1	68
MMSZ5270B	P5	91	86.45	95.55	1.4	400	2300	0.25	0.1	69

Note 1. Tested with pulses, Tp≤1.0ms.

RATING AND CHARACTERISTICS CURVES (MMSZ5221B-MMSZ5270B)

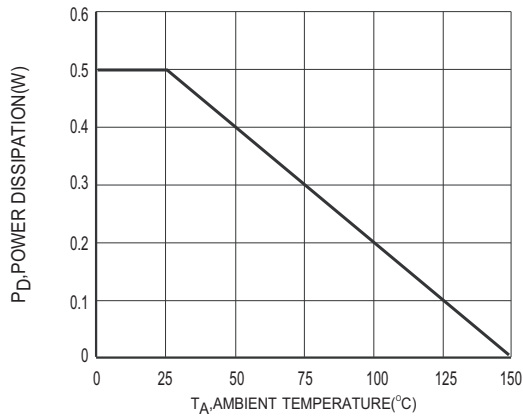

Figure 1 Power Dissipation vs Ambient Temperature

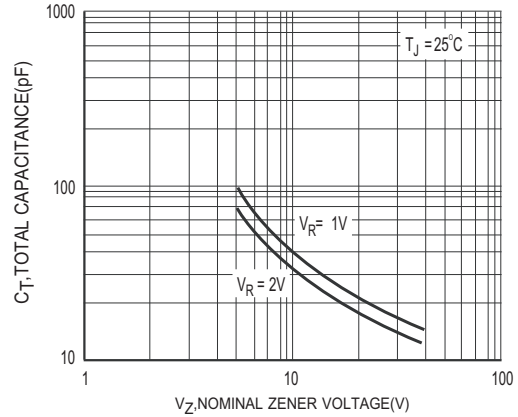

Figure 2 Typical Capacitance

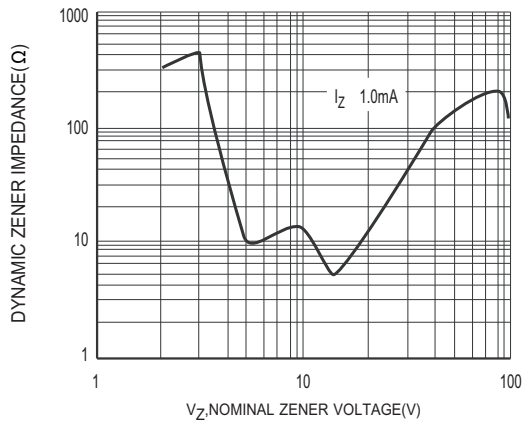

Figure 3 Zener Voltage vs Zener Impedance

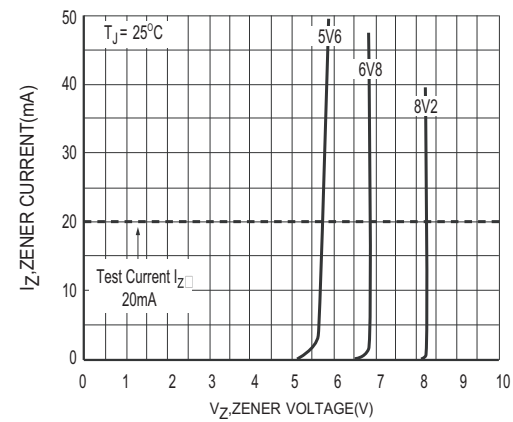

Figure 4 Zener Breakdown Characteristics

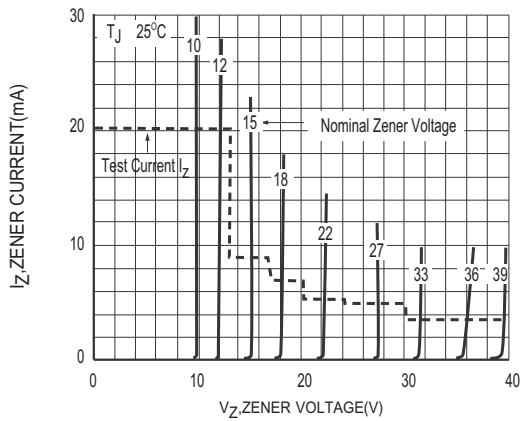

Figure 5 Zener Breakdown Characteristics

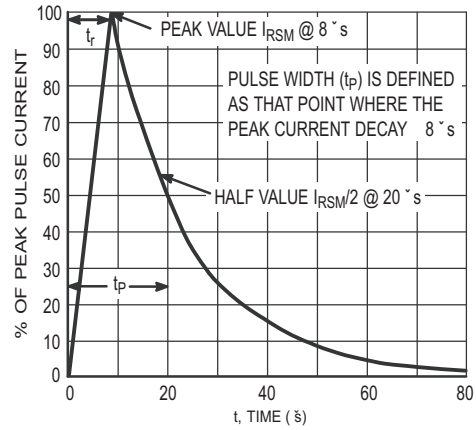

Figure 6. 8x20s Pulse Waveform

RATING AND CHARACTERISTICS CURVES (MMSZ5221B-MMSZ5270B)

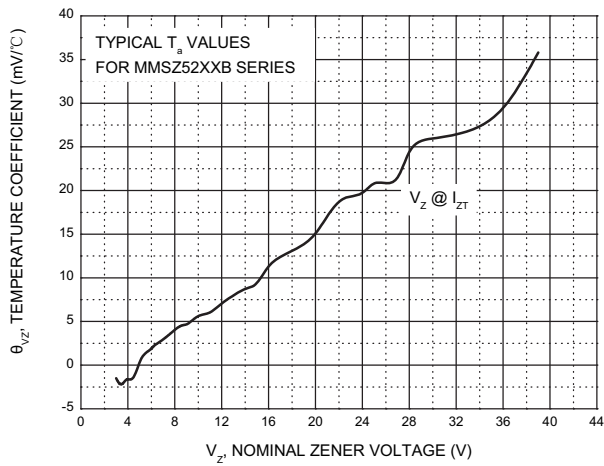

Figure 7 Typical Capacitance

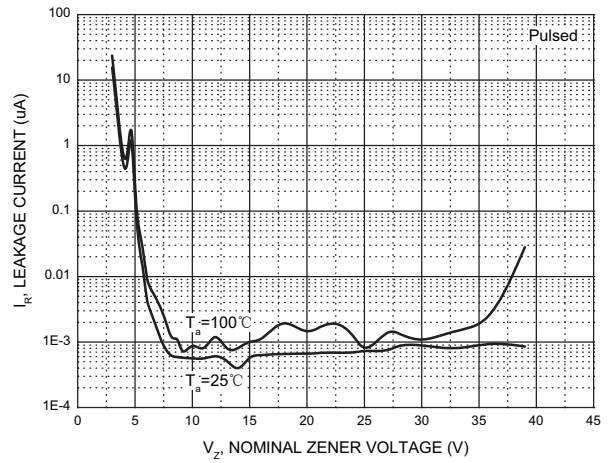

Figure 8 Effect of Zener Voltage on Zener Impedance

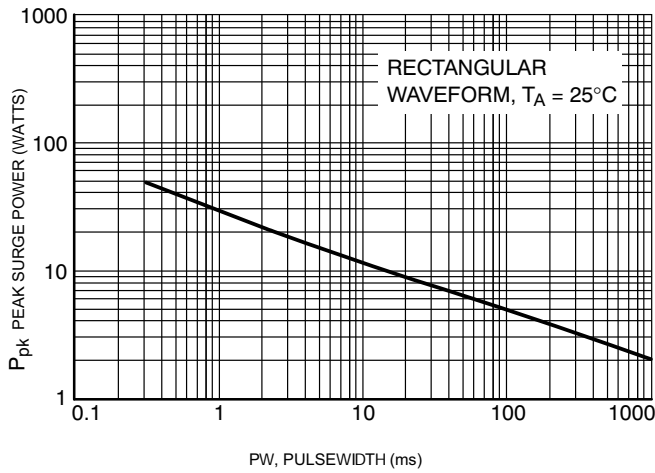

Figure 9. Maximum Nonrepetitive Surge Power

REEL TAPING SPECIFICATIONS FOR SURFACE MOUNT DEVICES-SOD-123

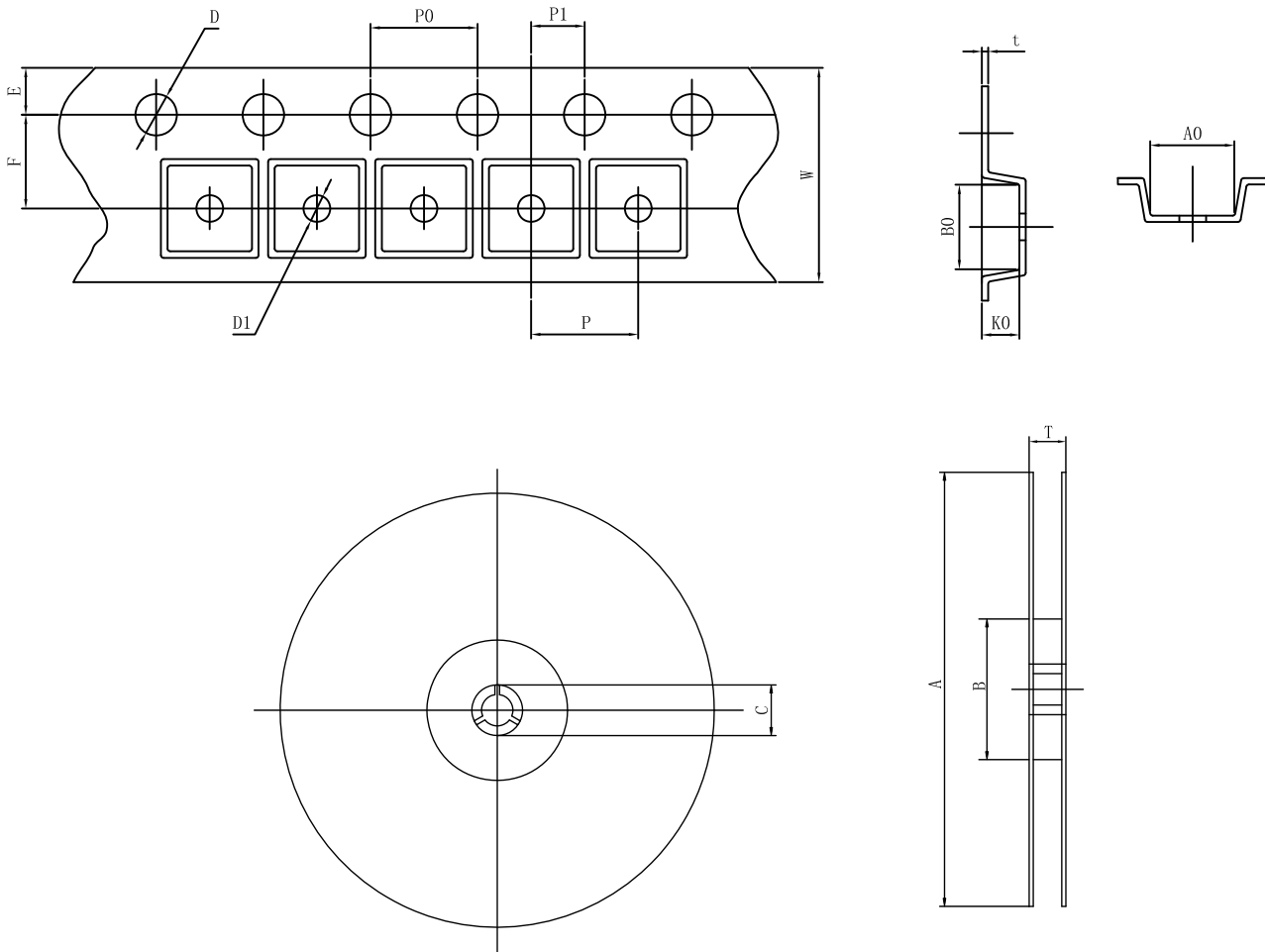

Fig.: Configuration of SOD-123 TAPING

ITEM	SYMBOL	SPECIFICATIONS (mm)	SPECIFICATIONS (inch)
Carrier width	A0	1.95 Max.	0.077 Max.
Carrier length	B0	4.04 Max.	0.159 Max.
Carrier depth	K0	1.67 Max.	0.066 Max.
Sprocket hole	D	1.55±0.05	0.061±0.002
Reel outside diameter	A	178±1.0	7.009±0.039
Reel inner diameter	B	54 Min.	2.126 Min.
Feed hole diameter	C	13.0±0.20	0.512±0.008
Strocket hole position	E	1.75±0.10	0.069±0.004
Punch hole position	F	3.5±0.05	0.138±0.002
Punch hole pitch	P	4.0±0.10	0.158±0.004
Sprocket hole pitch	P0	4.0±0.10	0.158±0.004
Embossment center	P1	2.0±0.05	0.079±0.002
Overall tape thickness	t	0.216 Max.	0.009 Max.
Tape width	W	8.0+0.2/-0.1	0.315+0.008/-0.004
Reel width	T	12.5 Max.	0.492 Max.
Punch hole diameter	D1	1.25 Max.	0.049 Max.

Note : Devices are packed in accordance with EIA standard RS-481-D and specification given above. Available only for SOD-123 devices.

PACKAGING OF DIODE

REEL PACK

PACKAGE	PACKING CODE	REEL (EA)	COMPONENT SPACE(mm)	TAPE SPACE (mm)	REEL DIA (mm)	CARTON SIZE (mm)	EA PER CARTON	GROSS WEIGHT(Kg)
SOD-123	-T	3,000	---	---	178	390*205*310	120,000	5.29

DISCLAIMER NOTICE

Rectron Inc reserves the right to make changes without notice to any product specification herein, to make corrections, modifications, enhancements or other changes. Rectron Inc or anyone on its behalf assumes no responsibility or liability for any errors or inaccuracies. Data sheet specifications and its information contained are intended to provide a product description only. "Typical" parameters which may be included on RECTRON data sheets and/ or specifications can and do vary in different applications and actual performance may vary over time. Rectron Inc does not assume any liability arising out of the application or use of any product or circuit.

Rectron products are not designed, intended or authorized for use in medical, life-saving implant or other applications intended for life-sustaining or other related applications where a failure or malfunction of component or circuitry may directly or indirectly cause injury or threaten a life without expressed written approval of Rectron Inc. Customers using or selling Rectron components for use in such applications do so at their own risk and shall agree to fully indemnify Rectron Inc and its subsidiaries harmless against all claims, damages and expenditures.



Компания «ЭлектроПласт» предлагает заключение долгосрочных отношений при поставках импортных электронных компонентов на взаимовыгодных условиях!

Наши преимущества:

- Оперативные поставки широкого спектра электронных компонентов отечественного и импортного производства напрямую от производителей и с крупнейших мировых складов;
- Поставка более 17-ти миллионов наименований электронных компонентов;
- Поставка сложных, дефицитных, либо снятых с производства позиций;
- Оперативные сроки поставки под заказ (от 5 рабочих дней);
- Экспресс доставка в любую точку России;
- Техническая поддержка проекта, помощь в подборе аналогов, поставка прототипов;
- Система менеджмента качества сертифицирована по Международному стандарту ISO 9001;
- Лицензия ФСБ на осуществление работ с использованием сведений, составляющих государственную тайну;
- Поставка специализированных компонентов (Xilinx, Altera, Analog Devices, Intersil, Interpoint, Microsemi, Aeroflex, Peregrine, Syfer, Eurofarad, Texas Instrument, Miteq, Cobham, E2V, MA-COM, Hittite, Mini-Circuits, General Dynamics и др.);

Помимо этого, одним из направлений компании «ЭлектроПласт» является направление «Источники питания». Мы предлагаем Вам помощь Конструкторского отдела:

- Подбор оптимального решения, техническое обоснование при выборе компонента;
- Подбор аналогов;
- Консультации по применению компонента;
- Поставка образцов и прототипов;
- Техническая поддержка проекта;
- Защита от снятия компонента с производства.



Как с нами связаться

Телефон: 8 (812) 309 58 32 (многоканальный)

Факс: 8 (812) 320-02-42

Электронная почта: org@eplast1.ru

Адрес: 198099, г. Санкт-Петербург, ул. Калинина, дом 2, корпус 4, литера А.