

## Inverter Grade Thyristors (Stud Version), 330 A

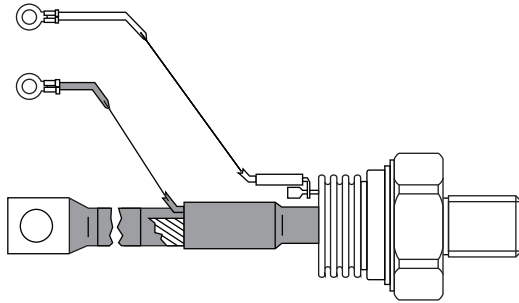

TO-209AE (TO-118)

**FEATURES**

- Center amplifying gate
- High surge current capability
- Low thermal impedance
- High speed performance
- Compression bonding
- Designed and qualified for industrial level
- Material categorization: For definitions of compliance please see [www.vishay.com/doc?99912](http://www.vishay.com/doc?99912)

**RoHS  
COMPLIANT**
**TYPICAL APPLICATIONS**

- Inverters
- Choppers
- Induction heating
- All types of force-commutated converters

**PRODUCT SUMMARY**

$I_{T(AV)}$	330 A
$V_{DRM}/V_{RRM}$	400 V, 2000 V
$V_{TM}$	1.96 V
$I_{TSM}$ at 50 Hz	11 000 A
$I_{TSM}$ at 60 Hz	11 520 A
$I_{GT}$	200 mA
$T_J$	-40 °C to 125 °C
Package	TO-209AE (TO-118)
Diode variation	Single SCR

**MAJOR RATINGS AND CHARACTERISTICS**

PARAMETER	TEST CONDITIONS	VALUES	UNITS
$I_{T(AV)}$		330	A
	$T_C$	75	°C
$I_{T(RMS)}$		518	A
$I_{TSM}$	50 Hz	11 000	
	60 Hz	11 520	
$I^2t$	50 Hz	605	kA <sup>2</sup> s
	60 Hz	550	
$V_{DRM}/V_{RRM}$		400 to 800	V
$t_q$		15	μs
$T_J$		-40 to 125	°C

**ELECTRICAL SPECIFICATIONS**
**VOLTAGE RATINGS**

TYPE NUMBER	VOLTAGE CODE	$V_{DRM}/V_{RRM}$ , MAXIMUM REPETITIVE PEAK VOLTAGE V	$V_{RSM}$ , MAXIMUM NON-REPETITIVE PEAK VOLTAGE V	$I_{DRM}/I_{RRM}$ MAXIMUM AT $T_J = T_J$ MAXIMUM mA
VS-ST333S	04	400	500	50
	08	800	900	



CURRENT CARRYING CAPABILITY							
FREQUENCY							UNITS
50 Hz	840	600	1280	1040	5430	4350	A
400 Hz	650	450	1280	910	2150	1560	
1000 Hz	430	230	1090	730	1080	720	
2500 Hz	140	60	490	250	400	190	
Recovery voltage $V_R$	50		50		50		V
Voltage before turn-on $V_D$	$V_{DRM}$		$V_{DRM}$		$V_{DRM}$		
Rise of on-state current $di/dt$	50		-		-		A/μs
Case temperature	50	75	50	75	50	75	°C
Equivalent values for RC circuit	10/0.47		10/0.47		10/0.47		Ω/μF

ON-STATE CONDUCTION					
PARAMETER	SYMBOL	TEST CONDITIONS		VALUES	UNITS
Maximum average on-state current at case temperature	$I_{T(AV)}$	180° conduction, half sine wave		330	A
				75	°C
Maximum RMS on-state current	$I_{T(RMS)}$	DC at 63 °C case temperature		518	A
Maximum peak, one half cycle, non-repetitive surge current	$I_{TSM}$	t = 10 ms	No voltage reapplied	11 000	
		t = 8.3 ms	No voltage reapplied	11 520	
		t = 10 ms	100 % $V_{RRM}$ reapplied	9250	
		t = 8.3 ms	100 % $V_{RRM}$ reapplied	9700	
Maximum $I^2t$ for fusing	$I^2t$	t = 10 ms	No voltage reapplied	605	kA <sup>2</sup> s
		t = 8.3 ms	No voltage reapplied	550	
		t = 10 ms	100 % $V_{RRM}$ reapplied	430	
		t = 8.3 ms	100 % $V_{RRM}$ reapplied	390	
Maximum $I^2\sqrt{t}$ for fusing	$I^2\sqrt{t}$	t = 0.1 ms to 10 ms, no voltage reapplied		6050	kA <sup>2</sup> √s
Maximum peak on-state voltage	$V_{TM}$	$I_{TM} = 1810$ A, $T_J = T_J$ maximum, $t_p = 10$ ms sine wave pulse		1.96	V
Low level value of threshold voltage	$V_{T(TO)1}$	$(16.7 \% \times \pi \times I_{T(AV)} < I < \pi \times I_{T(AV)})$ , $T_J = T_J$ maximum		0.91	
High level value of threshold voltage	$V_{T(TO)2}$	$(I > \pi \times I_{T(AV)})$ , $T_J = T_J$ maximum		0.92	
Low level value of forward slope resistance	$r_{t1}$	$(16.7 \% \times \pi \times I_{T(AV)} < I < \pi \times I_{T(AV)})$ , $T_J = T_J$ maximum		0.58	mΩ
High level value of forward slope resistance	$r_{t2}$	$(I > \pi \times I_{T(AV)})$ , $T_J = T_J$ maximum		0.58	
Maximum holding current	$I_H$	$T_J = 25$ °C, $I_T > 30$ A		600	mA
Typical latching current	$I_L$	$T_J = 25$ °C, $V_A = 12$ V, $R_a = 6$ Ω, $I_G = 1$ A		1000	

SWITCHING					
PARAMETER	SYMBOL	TEST CONDITIONS		VALUES	UNITS
Maximum non-repetitive rate of rise of turned-on current	$di/dt$	$T_J = T_J$ maximum, $V_{DRM} = \text{Rated } V_{DRM}$ $I_{TM} = 2 \times di/dt$		1000	A/μs
Typical delay time	$t_d$	$T_J = 25$ °C, $V_{DM} = \text{Rated } V_{DRM}$ , $I_{TM} = 50$ A DC, $t_p = 1$ μs Resistive load, gate pulse: 10 V, 5 Ω source		1.0	μs
Maximum turn-off time	$t_q$	$T_J = T_J$ maximum, $I_{TM} = 550$ A, commutating $di/dt = 40$ A/μs $V_R = 50$ V, $t_p = 500$ μs, $dV/dt = 200$ V/μs		15	



BLOCKING				
PARAMETER	SYMBOL	TEST CONDITIONS	VALUES	UNITS
Maximum critical rate of rise of off-state voltage	dV/dt	$T_J = T_J$ maximum, linear to 80 % $V_{DRM}$ , higher value available on request	500	V/ $\mu$ s
Maximum peak reverse and off-state leakage current	$I_{RRM}$ , $I_{DRM}$	$T_J = T_J$ maximum, rated $V_{DRM}/V_{RRM}$ applied	50	mA

TRIGGERING				
PARAMETER	SYMBOL	TEST CONDITIONS	VALUES	UNITS
Maximum peak gate power	$P_{GM}$	$T_J = T_J$ maximum, $f = 50$ Hz, $d\% = 50$	60	W
Maximum average gate power	$P_{G(AV)}$		10	
Maximum peak positive gate current	$I_{GM}$	$T_J = T_J$ maximum, $t_p \leq 5$ ms	10	A
Maximum peak positive gate voltage	+ $V_{GM}$		20	V
Maximum peak negative gate voltage	- $V_{GM}$		5	
Maximum DC gate current required to trigger	$I_{GT}$	$T_J = 25$ °C, $V_A = 12$ V, $R_a = 6$ $\Omega$	200	mA
Maximum DC gate voltage required to trigger	$V_{GT}$		3	V
Maximum DC gate current not to trigger	$I_{GD}$	$T_J = T_J$ maximum, rated $V_{DRM}$ applied	20	mA
Maximum DC gate voltage not to trigger	$V_{GD}$		0.25	V

THERMAL AND MECHANICAL SPECIFICATIONS				
PARAMETER	SYMBOL	TEST CONDITIONS	VALUES	UNITS
Maximum operating junction temperature range	$T_J$		-40 to 125	°C
Maximum storage temperature range	$T_{Stg}$		-40 to 150	
Maximum thermal resistance, junction to case	$R_{thJC}$	DC operation	0.10	K/W
Maximum thermal resistance, case to heatsink	$R_{thCS}$	Mounting surface, smooth, flat and greased	0.03	
Mounting torque, $\pm 10$ %		Non-lubricated threads	48.5 (425)	N · m (lbf · in)
Approximate weight			535	g
Case style		See dimensions - link at the end of datasheet	TO-209AE (TO-118)	

$\Delta R_{thJ-hs}$ CONDUCTION				
CONDUCTION ANGLE	SINUSOIDAL CONDUCTION	RECTANGULAR CONDUCTION	TEST CONDITIONS	UNITS
180°	0.011	0.008	$T_J = T_J$ maximum	K/W
120°	0.013	0.014		
90°	0.017	0.018		
60°	0.025	0.026		
30°	0.041	0.042		

**Note**

- The table above shows the increment of thermal resistance  $R_{thJ-hs}$  when devices operate at different conduction angles than DC

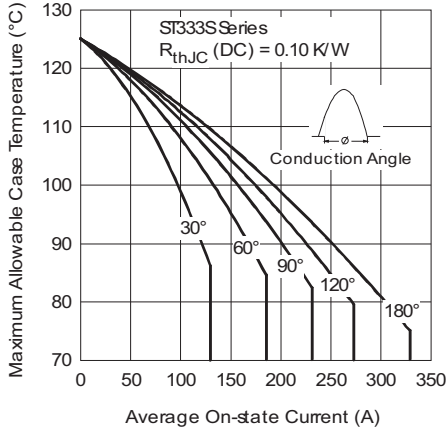

Fig. 1 - Current Ratings Characteristics

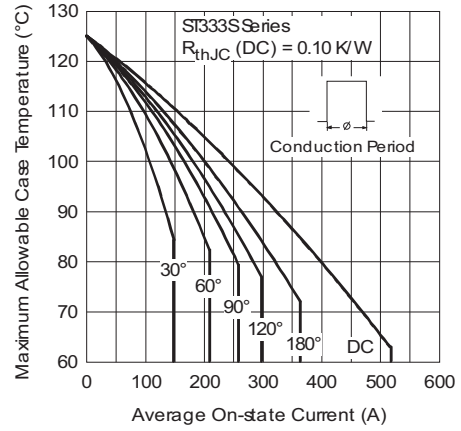

Fig. 2 - Current Ratings Characteristics

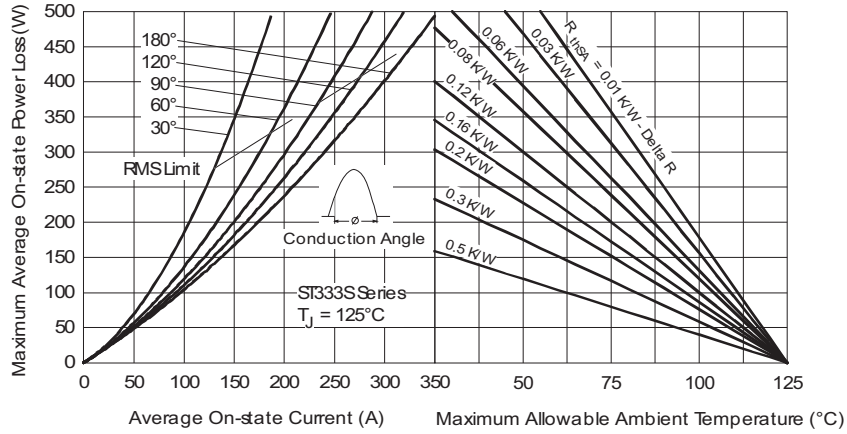

Fig. 3 - On-State Power Loss Characteristics

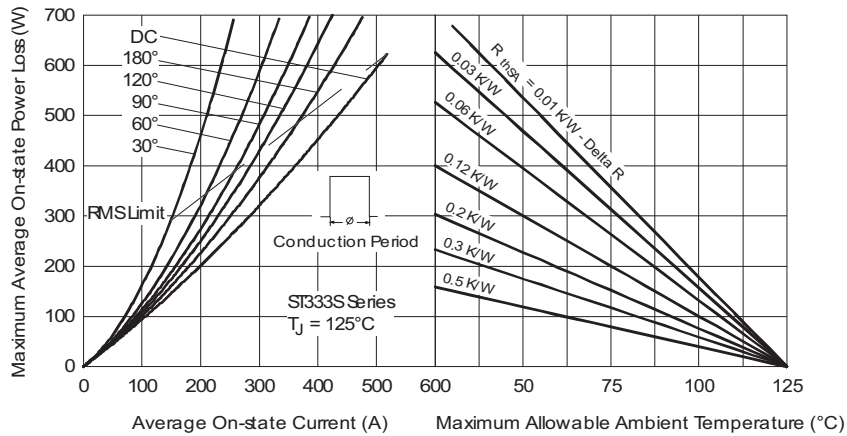

Fig. 4 - On-State Power Loss Characteristics

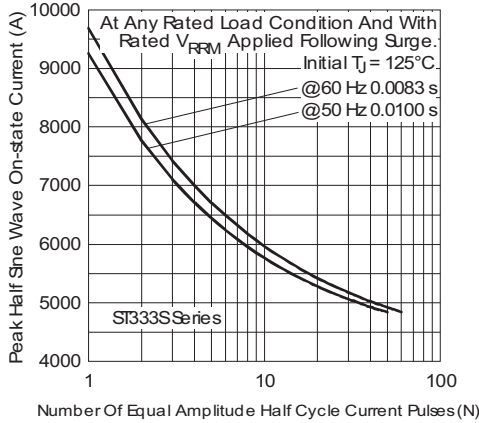

Fig. 5 - Maximum Non-Repetitive Surge Current

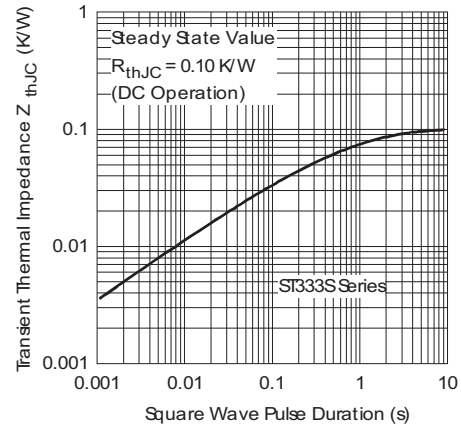

Fig. 8 - Thermal Impedance  $Z_{thJC}$  Characteristics

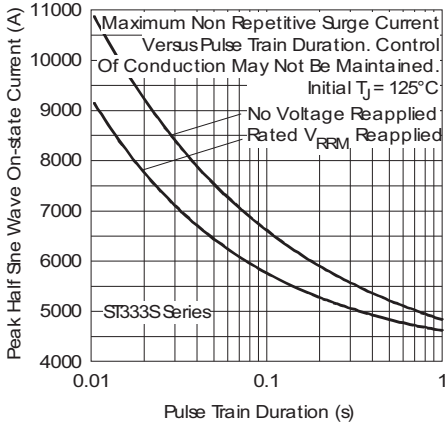

Fig. 6 - Maximum Non-Repetitive Surge Current

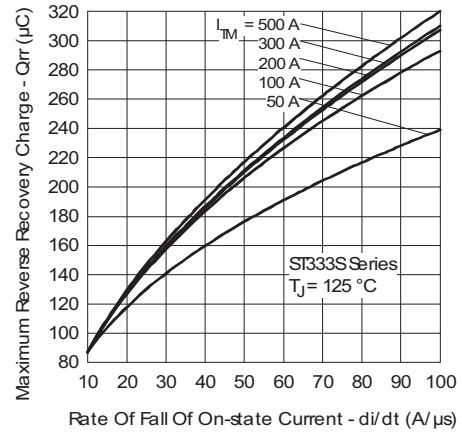

Fig. 9 - Reverse Recovered Charge Characteristics

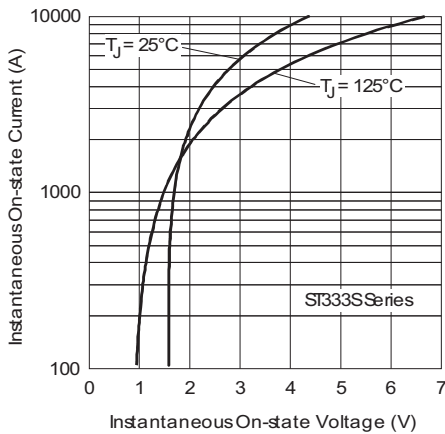

Fig. 7 - On-State Voltage Drop Characteristics

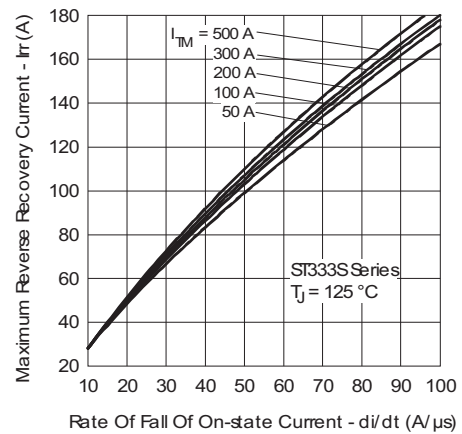

Fig. 10 - Reverse Recovery Current Characteristics

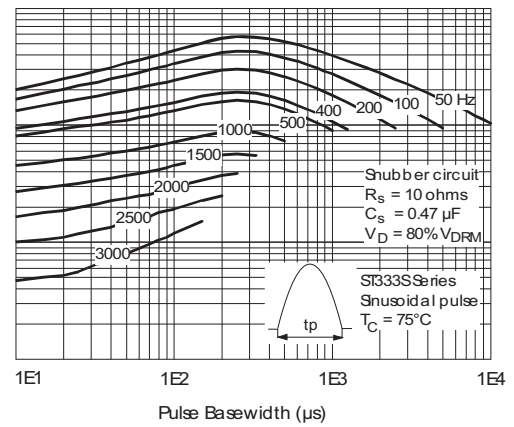
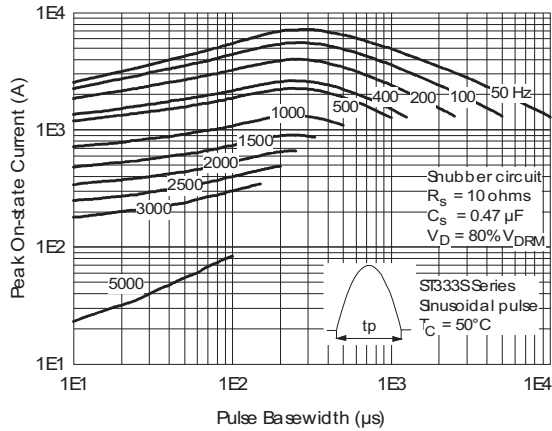

Fig. 11 - Frequency Characteristics

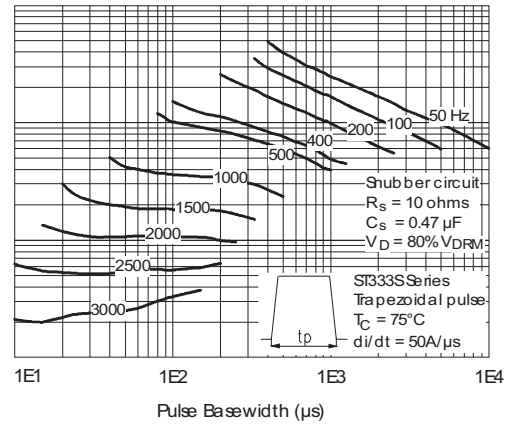
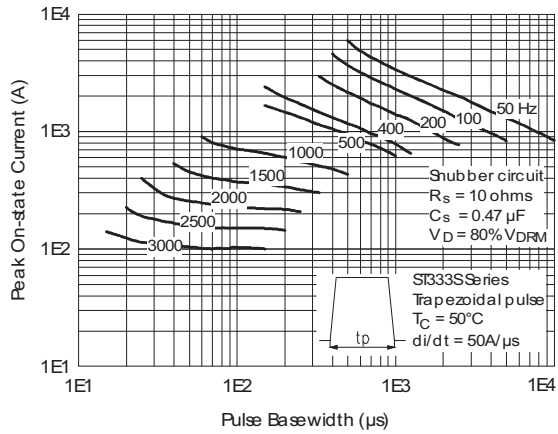

Fig. 12 - Frequency Characteristics

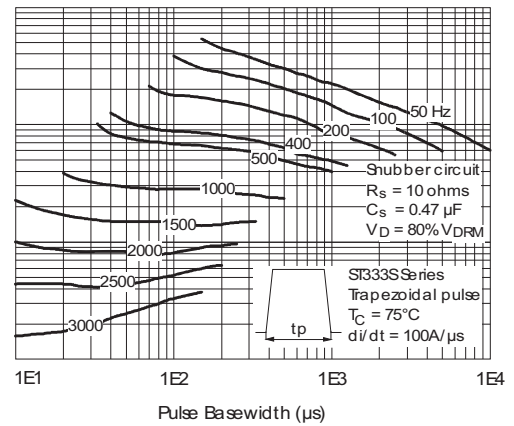
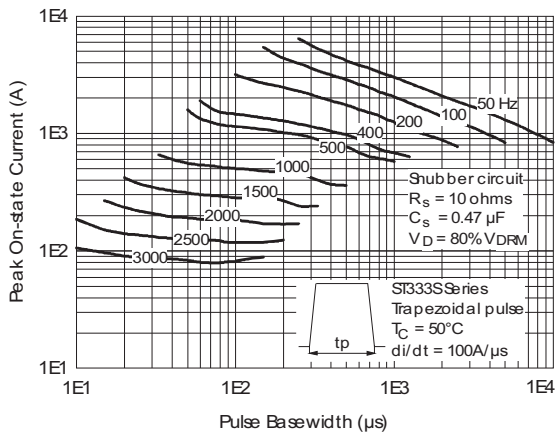

Fig. 13 - Frequency Characteristics

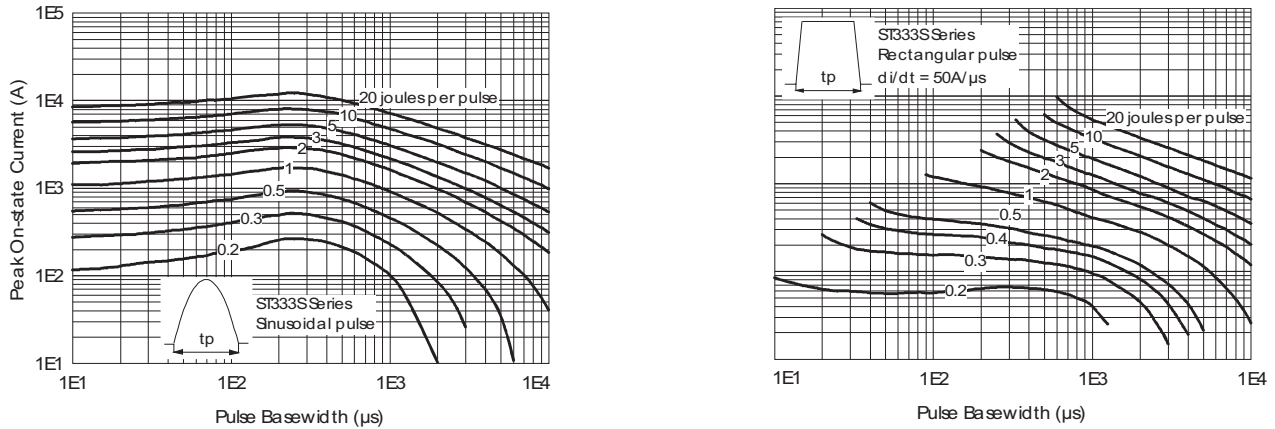

Fig. 14 - Maximum On-State Energy Power Loss Characteristics

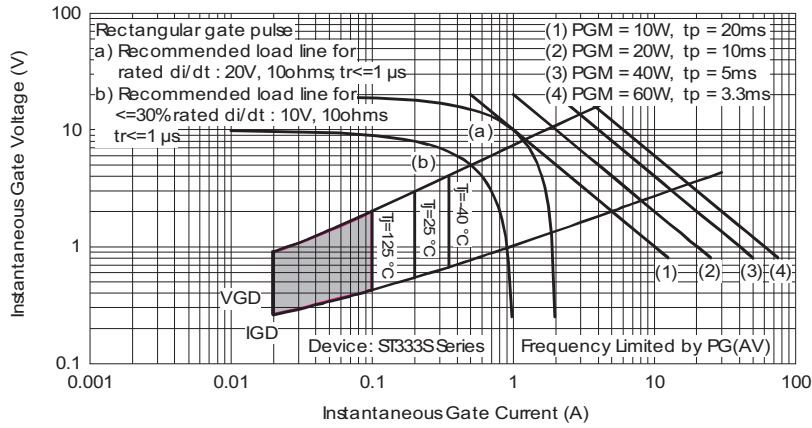
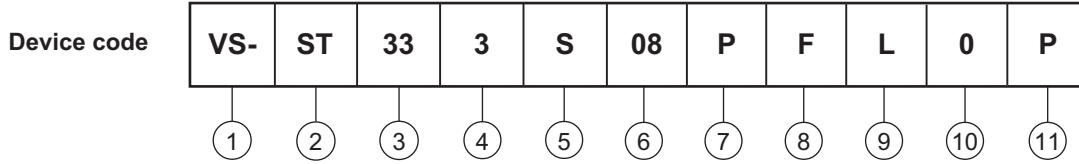

Fig. 15 - Gate Characteristics



## ORDERING INFORMATION TABLE



- 1** - Vishay Semiconductors product
- 2** - Thyristor
- 3** - Essential part number
- 4** - 3 = Fast turn-off
- 5** - S = Compression bonding stud
- 6** - Voltage code x 100 =  $V_{RRM}$   
(see Voltage Ratings table)
- 7** - P = Stud base 3/4" 16UNF-2A
- 8** - Reapplied dV/dt code (for  $t_q$  test condition) F = 200 V/ $\mu$ s
- 9** -  $t_q$  code (L = 15  $\mu$ s)
- 10** - 0 = Eyelet terminals  
(gate and auxiliary cathode leads)  
1 = Fast-on terminals  
(gate and auxiliary cathode leads)
- 11** - None = Standard production  
- P = Lead (Pb)-free

Note: For metric device M24 x 1.5 contact factory

LINKS TO RELATED DOCUMENTS	
Dimensions	<a href="http://www.vishay.com/doc?95080">www.vishay.com/doc?95080</a>



## TO-209AE (TO-118)

**DIMENSIONS** in millimeters (inches)

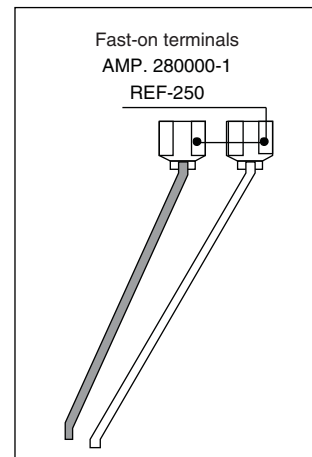
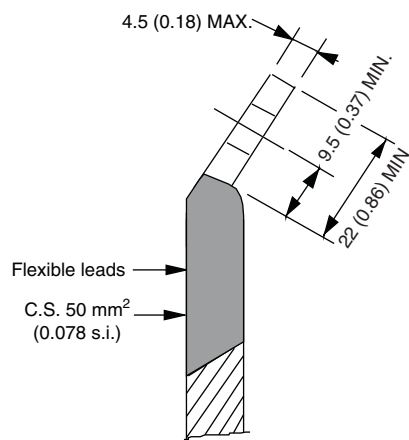

**Note**

<sup>(1)</sup> For metric device: M24 x 1.5 - length 21 (0.83) maximum



## Disclaimer

ALL PRODUCT, PRODUCT SPECIFICATIONS AND DATA ARE SUBJECT TO CHANGE WITHOUT NOTICE TO IMPROVE RELIABILITY, FUNCTION OR DESIGN OR OTHERWISE.

Vishay Intertechnology, Inc., its affiliates, agents, and employees, and all persons acting on its or their behalf (collectively, "Vishay"), disclaim any and all liability for any errors, inaccuracies or incompleteness contained in any datasheet or in any other disclosure relating to any product.

Vishay makes no warranty, representation or guarantee regarding the suitability of the products for any particular purpose or the continuing production of any product. To the maximum extent permitted by applicable law, Vishay disclaims (i) any and all liability arising out of the application or use of any product, (ii) any and all liability, including without limitation special, consequential or incidental damages, and (iii) any and all implied warranties, including warranties of fitness for particular purpose, non-infringement and merchantability.

Statements regarding the suitability of products for certain types of applications are based on Vishay's knowledge of typical requirements that are often placed on Vishay products in generic applications. Such statements are not binding statements about the suitability of products for a particular application. It is the customer's responsibility to validate that a particular product with the properties described in the product specification is suitable for use in a particular application. Parameters provided in datasheets and/or specifications may vary in different applications and performance may vary over time. All operating parameters, including typical parameters, must be validated for each customer application by the customer's technical experts. Product specifications do not expand or otherwise modify Vishay's terms and conditions of purchase, including but not limited to the warranty expressed therein.

Except as expressly indicated in writing, Vishay products are not designed for use in medical, life-saving, or life-sustaining applications or for any other application in which the failure of the Vishay product could result in personal injury or death. Customers using or selling Vishay products not expressly indicated for use in such applications do so at their own risk. Please contact authorized Vishay personnel to obtain written terms and conditions regarding products designed for such applications.

No license, express or implied, by estoppel or otherwise, to any intellectual property rights is granted by this document or by any conduct of Vishay. Product names and markings noted herein may be trademarks of their respective owners.

## Material Category Policy

**Vishay Intertechnology, Inc. hereby certifies that all its products that are identified as RoHS-Compliant fulfill the definitions and restrictions defined under Directive 2011/65/EU of The European Parliament and of the Council of June 8, 2011 on the restriction of the use of certain hazardous substances in electrical and electronic equipment (EEE) - recast, unless otherwise specified as non-compliant.**

**Please note that some Vishay documentation may still make reference to RoHS Directive 2002/95/EC. We confirm that all the products identified as being compliant to Directive 2002/95/EC conform to Directive 2011/65/EU.**

**Vishay Intertechnology, Inc. hereby certifies that all its products that are identified as Halogen-Free follow Halogen-Free requirements as per JEDEC JS709A standards. Please note that some Vishay documentation may still make reference to the IEC 61249-2-21 definition. We confirm that all the products identified as being compliant to IEC 61249-2-21 conform to JEDEC JS709A standards.**



Компания «ЭлектроПласт» предлагает заключение долгосрочных отношений при поставках импортных электронных компонентов на взаимовыгодных условиях!

Наши преимущества:

- Оперативные поставки широкого спектра электронных компонентов отечественного и импортного производства напрямую от производителей и с крупнейших мировых складов;
- Поставка более 17-ти миллионов наименований электронных компонентов;
- Поставка сложных, дефицитных, либо снятых с производства позиций;
- Оперативные сроки поставки под заказ (от 5 рабочих дней);
- Экспресс доставка в любую точку России;
- Техническая поддержка проекта, помощь в подборе аналогов, поставка прототипов;
- Система менеджмента качества сертифицирована по Международному стандарту ISO 9001;
- Лицензия ФСБ на осуществление работ с использованием сведений, составляющих государственную тайну;
- Поставка специализированных компонентов (Xilinx, Altera, Analog Devices, Intersil, Interpoint, Microsemi, Aeroflex, Peregrine, Syfer, Eurofarad, Texas Instrument, Miteq, Cobham, E2V, MA-COM, Hittite, Mini-Circuits, General Dynamics и др.);

Помимо этого, одним из направлений компании «ЭлектроПласт» является направление «Источники питания». Мы предлагаем Вам помощь Конструкторского отдела:

- Подбор оптимального решения, техническое обоснование при выборе компонента;
- Подбор аналогов;
- Консультации по применению компонента;
- Поставка образцов и прототипов;
- Техническая поддержка проекта;
- Защита от снятия компонента с производства.



#### Как с нами связаться

**Телефон:** 8 (812) 309 58 32 (многоканальный)

**Факс:** 8 (812) 320-02-42

**Электронная почта:** [org@eplast1.ru](mailto:org@eplast1.ru)

**Адрес:** 198099, г. Санкт-Петербург, ул. Калинина, дом 2, корпус 4, литера А.