

A3C

Pushbutton Switch (Lighted/Non-Lighted) (Cylindrical 12-dia.)

CSM_A3C_DS_E_2_1

Pushbutton Switch Series with Cylindrical 20-mm × 12-dia. Body

- High-intensity uniform surface lighting.
- Round body enables easy hole making.
- Miniature size with excellent feeling of operation.

RoHS Compliant

⚠ Refer to *Safety Precautions for All Pushbutton Switches* and *Safety Precautions* on page 12.

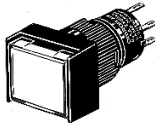
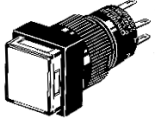
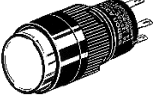

List of Models

| Appearance | Model |
|--|-------|
| Rectangular Models  | A3CJ |
| Square Models  | A3CA |
| Round Models  | A3CT |

■ Specifications: Refer to page 8. ■ Dimensions: Refer to page 10. ■ Accessories: Refer to page 7.
■ Precautions for correct use and safety precautions: Refer to page 12.

Model Number LegendWhen placing your order, specify the individual component part model numbers of the Pushbutton, Lamp (lighted models only), and Switch, as listed in the ordering tables below.

For information on combinations, refer to *Ordering Information* on page 3.



Ordering Information

Ordering as a Set The model numbers used to order sets of Units are given in the following tables. One set comprises the Pushbutton, Lamp (lighted models only), and Switch.



Lighted Pushbutton Switches (SPST-NO+SPST-NC Solder Terminals)

| Shape | Operation Lighting | Standard load | | Microload | Pushbutton color symbol (Color) |
|-----------------------|-----------------------|--------------------------------------|------------------------------------|--------------------------------------|--|
| | | Momentary operation (Self-resetting) | Alternate operation (Self-holding) | Momentary operation (Self-resetting) | |
| | | Set | Set | Set | |
| Rectangular (A3CJ) | LED lamp | A3CJ-90A1-05E□ | A3CJ-90B1-05E□ | A3CJ-90E1-05E□ | R: red Y: yellow G: green W: white |
| | | A3CJ-90A1-12E□ | A3CJ-90B1-12E□ | A3CJ-90E1-12E□ | |
| | | A3CJ-90A1-24E□ | A3CJ-90B1-24E□ | A3CJ-90E1-24E□ | |
| | Incandescent lamp | A3CJ-90A1-06□ | --- | --- | R: red Y: yellow G: green W: white A: blue B: black * |
| | | A3CJ-90A1-14□ | | | |
| | | A3CJ-90A1-28□ | A3CJ-90B1-28□ | | |
| Non-lighted | A3CJ-90A0-□ | A3CJ-90B0-□ | A3CJ-90E0-□ | | |
| Square (A3CA) | LED lamp | A3CA-90A1-05E□ | A3CA-90B1-05E□ | A3CA-90E1-05E□ | R: red Y: yellow G: green W: white |
| | | A3CA-90A1-12E□ | A3CA-90B1-12E□ | A3CA-90E1-12E□ | |
| | | A3CA-90A1-24E□ | A3CA-90B1-24E□ | A3CA-90E1-24E□ | |
| | Incandescent lamp | A3CA-90A1-06□ | --- | --- | R: red Y: yellow G: green W: white A: blue B: black * |
| | | A3CA-90A1-14□ | | | |
| | | A3CA-90A1-28□ | A3CA-90B1-28□ | | |
| Non-lighted | A3CA-90A0-□ | A3CA-90B0-□ | A3CA-90E0-□ | | |
| Round (A3CT) | LED lamp | A3CT-90A1-05E□ | A3CT-90B1-05E□ | A3CT-90E1-05E□ | R: red Y: yellow G: green W: white |
| | | A3CT-90A1-12E□ | A3CT-90B1-12E□ | A3CT-90E1-12E□ | |
| | | A3CT-90A1-24E□ | A3CT-90B1-24E□ | A3CT-90E1-24E□ | |
| | Incandescent lamp | A3CT-90A1-06□ | --- | --- | R: red Y: yellow G: green W: white A: blue B: black * |
| | | A3CT-90A1-14□ | | | |
| | | A3CT-90A1-28□ | A3CT-90B1-28□ | | |
| Non-lighted | A3CT-90A0-□ | A3CT-90B0-□ | A3CT-90E0-□ | | |

Note: 1. Enter the desired color symbol for the Pushbutton in the □ at the end of the model number.
 2. There are also alternate-operation models that can be used for microloads. Refer to the Switch table on page 6.
 * Black ("B") Pushbuttons are only available for non-lighted models.

Individual models: Refer to pages 5 to 6.
 (The Pushbutton, Lamp, and Switch can be ordered separately.)

■ Specifications: Refer to page 8. ■ Dimensions: Refer to page 10.
 ■ Accessories: Refer to page 7.

Ordering Information

Illumination-only and Colored-illumination LED Models

"Illumination only" describes LED models for which the screen color is the same whether the LED is lit or not.

Example: Red LED

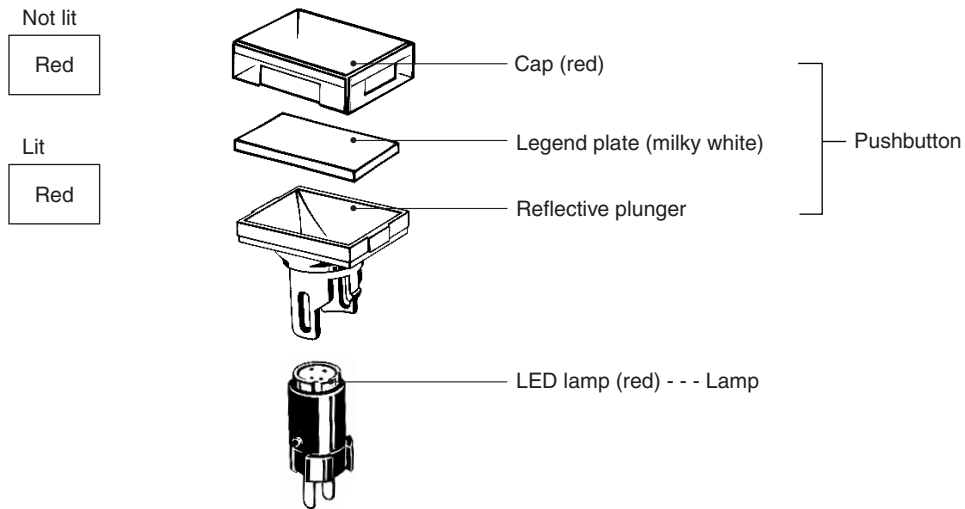

"Colored illumination" describes LED models for which the screen color is white when the LED is not lit and changes to the color of the LED lamp when the LED is lit.

Example: Red LED

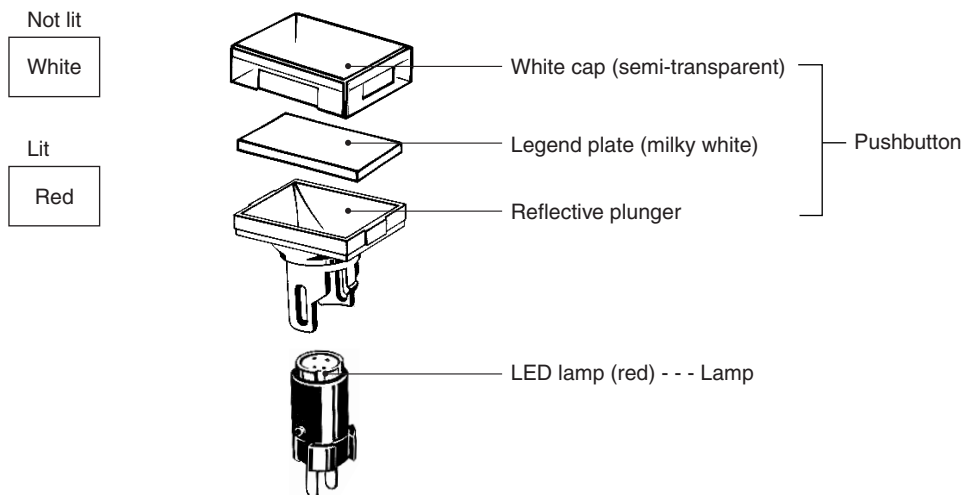

Ordering: With colored-illumination models, order the Pushbutton, Lamp, and Switch as shown in the following table.

| Illuminated color | Pushbutton | Lamp (LED) | | Switch |
|-------------------|--|----------------|--|---|
| Red | IP40 A3C□-500W Enter one of the following symbols in □. J: Rectangular A: Square T: Round | A16-□DR | Enter one of the following symbols in □. 5: 5 VDC 12: 12 VDC 24: 24 VDC | Refer to page 6. Make the selection according to the shape of the Pushbutton. |
| Yellow | | A16-□DY | | |
| Green | | A16-□DG | | |

Ordering Information

Ordering Individually Pushbuttons, Lamps, and Switches can be ordered separately. Combinations that are not available as sets can be created using individual Units. Also, store the parts as spares for maintenance and repairs.

Ordering: Specify a model number from the following page.

LED Lamp



Non-lighted Models

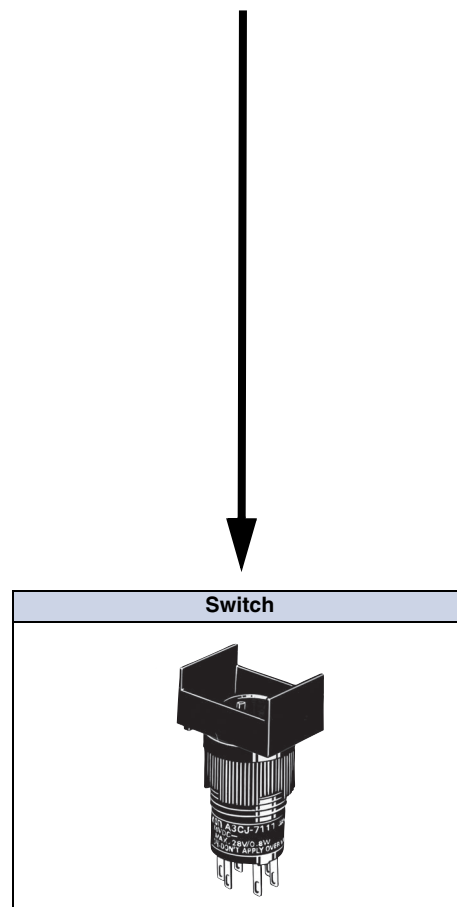
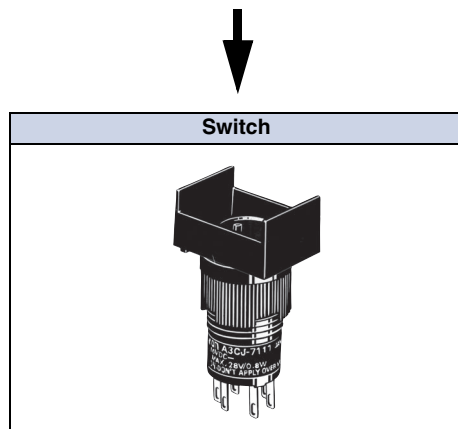
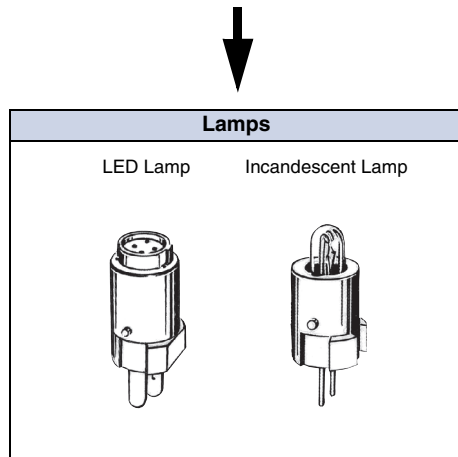
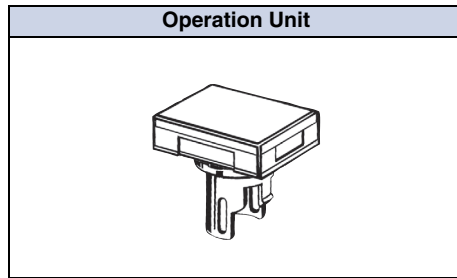

Ordering set combinations: Refer to page 3.

■ Specifications: Refer to page 8. ■ Dimensions: Refer to page 10.
■ Accessories: Refer to page 7.

Ordering Information

Ordering Individually Pushbuttons, Lamps, and Switches can be ordered separately. Combinations that are not available as sets can be created using individual Units. Also, store the parts as spares for maintenance and repairs.

Pushbuttons

LED Lamp

| Shape | Rectangular | Square | Round |
|--------------|---|---|---|
| Button color |  |  |  |
| Red | A3CJ-500R | A3CA-500R | A3CT-500R |
| Yellow | A3CJ-500Y | A3CA-500Y | A3CT-500Y |
| Green | A3CJ-500GY | A3CA-500GY | A3CT-500GY |
| White | A3CJ-500W | A3CA-500W | A3CT-500W |

Note: The red, yellow, and white Pushbuttons listed above can be used with either LED lamp-lighted models or incandescent lamp-lighted models.

Non-lighted Models

| Shape | Rectangular | Square | Round |
|--------------|--|---|---|
| Button color |  |  |  |
| Red | A3CJ-500R | A3CA-500R | A3CT-500R |
| Yellow | A3CJ-500Y | A3CA-500Y | A3CT-500Y |
| Green | A3CJ-500G | A3CA-500G | A3CT-500G |
| White | A3CJ-500W | A3CA-500W | A3CT-500W |
| Blue | A3CJ-500A | A3CA-500A | A3CT-500A |
| Black | A3CJ-501B | A3CA-501B | A3CT-501B |

Note: Models other than black can also be used with incandescent lamps.

Incandescent Lamp

| Shape | Rectangular | Square | Round |
|--------------|---|---|---|
| Button color |  |  |  |
| Red | A3CJ-500R | A3CA-500R | A3CT-500R |
| Yellow | A3CJ-500Y | A3CA-500Y | A3CT-500Y |
| Green | A3CJ-500G | A3CA-500G | A3CT-500G |
| White | A3CJ-500W | A3CA-500W | A3CT-500W |
| Blue | A3CJ-500A | A3CA-500A | A3CT-500A |

Lamps

LED Lamp

| Color Rated voltage | Red | Yellow | Green | White |
|------------------------|----------|----------|----------|----------|
| 5 VDC | A16-5DR | A16-5DY | A16-5DG | A16-5DW |
| 12 VDC | A16-12DR | A16-12DY | A16-12DG | A16-12DW |
| 24 VDC | A16-24DR | A16-24DY | A16-24DG | A16-24DW |

Incandescent Lamp

| Rated voltage | Model |
|---------------|--------|
| 6 VAC/DC | A16-5 |
| 14 VAC/DC | A16-12 |
| 28 VAC/DC | A16-24 |

Switches

| Sealing | | | | Degree of protection: IP40 | | |
|---------------|---------------------|-----------|--------|---|--|---|
| Shape | | | | Rectangular | Square | Round |
| Contact type | | | |  |  |  |
| Standard load | SPST-NO+ SPST NC | Momentary | Solder | A3CJ-7011 | A3CA-7011 | A3CT-7011 |
| | | Alternate | | A3CJ-7021 | A3CA-7021 | A3CT-7021 |
| Microload | | Momentary | Solder | A3CJ-7111 | A3CA-7111 | A3CT-7111 |
| | | Alternate | | A3CJ-7121 | A3CA-7121 | A3CT-7121 |



Ordering set combinations: Refer to page 3.

■ Specifications: Refer to page 8. ■ Dimensions: Refer to page 10.
■ Accessories: Refer to page 7.

Ordering Information

Accessories, Replacements, and Tools

Accessories

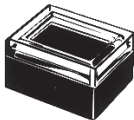
| Name | Appearance | Classification | Model | Remarks |
|------------------|---|--------------------------|------------------|--|
| Socket |  | Wire-wrap terminal | A3C-4101 | Cannot be used with Insulation Cover. |
| | | PCB terminal | A3C-4102 | |
| | | Solder terminal | A3C-4103 | |
| Insulation Cover |  | --- | A3C-3002 | Cannot be used with Socket. |
| Switch Guard |  | For rectangular models | A3CJ-5050 | Cannot be used with Dust Cover. |
| | | For square, round models | A3CA-5050 | |
| Dust Cover |  | For rectangular models | A3CJ-5060 | Cannot be used with Switch Guard. Can be used with Dust Cover attached. |

Tools

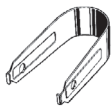
| Name | Appearance | Classification | Model | Remarks |
|-----------------|---|----------------|------------------|--|
| Tightening Tool |  | --- | A3C-3004 | The tightening torque is 0.20 to 0.39 N·m. |
| Extractor |  | --- | A3PJ-5080 | --- |

Replacements

| Name | Appearance | Classification | Model | Remarks |
|--------------|---|------------------------|------------------|--|
| Legend Plate |  | For rectangular models | A3CJ-5201 | One Legend Plate (milk-white) is supplied per standard Switch. |
| | | For square models | A3CA-5201 | |
| | | For round models | A3CT-5201 | |

■ Specifications: Refer to page 8. ■ Dimensions: Refer to page 10.

Approved Standard Ratings

UL (File No. E41515), CSA (File No. LR45258)

Standard Load: 0.5 A at 250 VAC
1 A at 125 VAC
1 A at 30 VDC

Microload: 0.1 A at 125 VAC
0.1 A at 30 VDC

Note: Certification has been obtained for the Switch Unit.
For detailed information on individual products that have received certification, consult your supplier.

CCC (GB14048.5)

Standard Load: 0.5 A at 250 VAC
Microload: 0.1 A at 250 VAC

Ratings

| Model | Item | AC resistive load | DC resistive load |
|---------------|-------------|------------------------------------|-------------------|
| Standard load | | 0.5 A at 250 VAC 1 A at 125 VAC | 1 A at 30 VDC |
| | Microload * | 0.1 A at 125 VAC | 0.1 A at 30 VDC |

Note: The above ratings are for testing under the following conditions:

- 1) Load: Resistive load
- 2) Mounting conditions: No vibrations or shock
- 3) Temperature: 20°C ± 2°C
- 4) Operation frequency: 20 operations/minute

* The minimum permissible load is 1 mA, 5 VDC.

LED Lamp

| Rated voltage | Rated current | Operating voltage | Internal limiting resistance |
|---------------|---------------|-------------------|------------------------------|
| 5 VDC | 30 mA | 5 VDC ± 5% | 33 Ω |
| 12 VDC | 15 mA | 12 VDC ± 5% | 270 Ω |
| 24 VDC | 10 mA | 24 VDC ± 5% | 1,600 Ω |

Incandescent Lamp

| Rated voltage | Rated current | Operating voltage |
|---------------|---------------|-------------------|
| 6 VAC/DC | 60 mA | 5 VAC/DC |
| 14 VAC/DC | 40 mA | 12 VAC/DC |
| 28 VAC/DC | 24 mA | 24 VAC/DC |

Characteristics

| | | |
|---------------------------------|---|---|
| Operating frequency | Mechanical | Momentary-action models: 120 operations/minute max. Alternate-action models: 60 operations/minute max. *1 |
| | Electrical | 20 operations/minute max. |
| Contact Resistance | Standard load | 50mΩ max. |
| | Microload | 100mΩ max. |
| Insulation resistance | | 100 MΩ min. (at 500 VDC) |
| Dielectric strength | Between terminals of same polarity | 1,000 VAC, 50/60 Hz for 1 min |
| | Between terminals of different polarity | 2,000 VAC, 50/60 Hz for 1 min |
| | Between each terminal and ground | 2,000 VAC, 50/60 Hz for 1 min |
| | Between lamp terminals | 1,000 VAC, 50/60 Hz for 1 min *2 |
| Vibration resistance | Malfunction | 10 to 55 Hz, 1.5-mm double amplitude *3 |
| Shock resistance | Destruction | 500 m/s ² |
| | Malfunction | 150 m/s ² *3 |
| Durability | Mechanical | Momentary-operation models: 1,000,000 operations min. Alternate-operation models: 100,000 operations min. *1 |
| | Electrical | 100,000 operations min. |
| Weight | | Approx. 5 g <The weight indicated here applies to the lighted models (SPST-NO+SPST-NC).> |
| Ambient operating temperature | | -10°C to +55°C (with no icing or condensation) |
| Ambient operating humidity | | 35% to 85%RH |
| Ambient storage temperature | | -25°C to +65°C (with no icing or condensation) |
| Degree of protection | | IP40 |
| Electric shock protection class | | Class II |
| PTI (proof tracking index) | | 175 |
| Pollution degree | | 3 (IEC60947-5-1) |

*1. With alternate-operation models, one operation cycle consists of set and reset operations.

*2. The figure given above for the dielectric strength between lamp terminals is for when there is no LED lamp or incandescent lamp mounted.

*3. No malfunction for more than 1s.

Operating Characteristics

| | | |
|-----------------------|------------|-----------------|
| Operating force | OF max. | 2.45 N {250 gf} |
| Releasing force | RF min. | 0.29 N {30 gf} |
| Total travel | TT | Approx. 3.5 mm |
| Lock travel alternate | LTA min. * | 0.5 mm |
| Pretravel | PT max. | 2.5 mm |

* Alternate operation models only.

Contact Form

| Contact name | Contact form |
|--------------|--------------|
| SPDT | |

Nomenclature
Model Structure
Display Unit Structure



Note: The A3CJ model is shown here as a representative example.

| | Type | Specifications |
|-----|--|--|
| (1) | Shape of Pushbutton Rectangular (A3CJ) Square (A3CA) Round (A3CT) | ----- |
| (2) | LED lamp-lighted Models: Red, Yellow, Green, White Incandescent lamp-lighted Models: Red, Yellow, Green, White, Blue Non-lighted Models: Red, Yellow, Green, White, Blue, Black | ----- |
| (3) | LED Lamp Incandescent Lamp | |
| (4) | Standard load Microload | 0.5 A at 250 VAC 1 A at 125 VAC 1 A at 30 VDC 0.1 A at 125 VAC 0.1 A at 30 VDC Minimum applicable load: 1 mA at 5 VDC |

Dimensions



Terminal Connections



Panel Cutout (Top View)



• If the panel is to be finished (e.g., coated), make sure that the panel meets the specified dimensions after the coating.

Dimensions

Accessory Mounting Dimensions

Dimensions with Socket Mounted (The diagrams below show the external dimensions for rectangular models as representative models.)



Switch Guard



Dust Cover A3CJ-5060

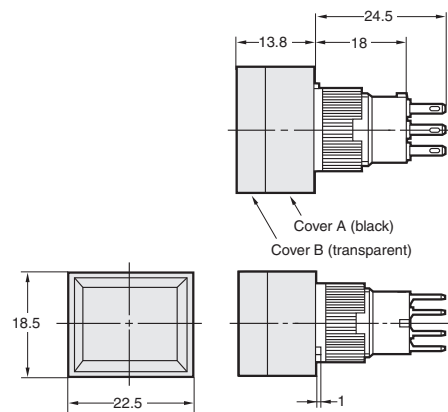

Legend Plate

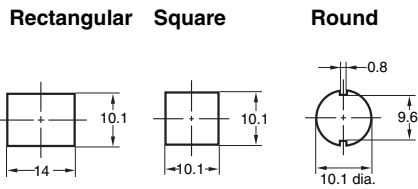

Note: 1. The thickness is 0.8 mm.
2. Since the Legend Plate is made of polycarbonate, use alcohol-based paints such as melanin, phthalic acid, or acrylic paint when marking the legend.

Insulation Cover A3C-3002

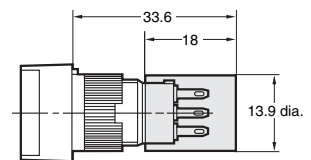

Safety Precautions

Refer to *Safety Precautions for All Pushbutton Switches*.

CAUTION

Do not apply a voltage higher than the maximum rated operating voltage between the lamp terminals, as there is a risk that the incandescent lamp or LED lamp will be damaged, and the Pushbutton will be ejected.



When replacing the incandescent lamp, first turn OFF the power supply, and then wait 10 minutes before performing replacement, as the lamp is still hot immediately after the power is turned OFF, so there is a risk of burns.



Precautions for Correct Use

Mounting

- To prevent electric shock or a fire, always make sure that the power is turned OFF before mounting, removing, or wiring the Switch, or performing maintenance.
- Do not tighten the mounting ring excessively using pliers or a similar tool. Excessive tightening may damage the mounting ring. (Tightening torque: 0.20 to 0.39 N·m {20 gf to 40 gf})

Wiring

- When wiring, use wires of a size appropriate for the applied voltage and carry current. Perform soldering correctly under the conditions given below. Using the Switch with the wires soldered incorrectly may cause the terminals to become abnormally hot and cause a fire.

1. Soldering iron tip temperature: 350°C max. within 3 seconds.
2. Dip soldering: At 350°C within 3 seconds.

Wait for one minute after soldering before exerting any external force on the solder.

- Use a non-corrosive rosin liquid for the flux.
- Perform wiring so that the wire sheaths do not come into contact with the Switch. If this is unavoidable, use wires that can withstand temperatures of 100°C min.
- After wiring to the Switch has been completed, ensure an appropriate insulation distance.

Operating Environment

- Do not use in locations that are subject to dust, oil, or metal filings as these may penetrate the interior of the Switch and cause malfunction.

Using Microloads

- Using a standard load switch for opening and closing a microload circuit may cause wear on the contacts. Use the switch within the operating range. (Refer to the diagram below.) Even when using microload models within the operating range shown below, if inrush current occurs when the contact is opened or closed, it may cause the contact surface to become rough, and so decrease life expectancy. Therefore, insert a contact protection circuit where necessary. The minimum applicable load is the N-level reference value. This value indicates the malfunction reference level for the reliability level of 60% ($\lambda 60$) (conforming to JIS C5003). The equation, $\lambda 60 = 0.5 \times 10^{-6}/\text{times}$ indicates that the estimated malfunction rate is less than 1/2,000,000 with a reliability level of 60%.

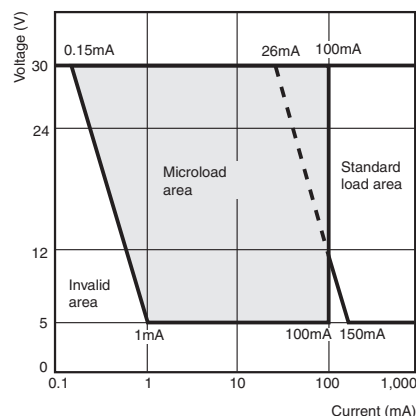

LED

- Resistance to limit the LED current is provided internally and so an external resistance is not required.

| Rated voltage | Internal limiting resistance |
|---------------|------------------------------|
| 5 VDC | 33 Ω |
| 12 VDC | 270 Ω |
| 24 VDC | 1,600 Ω |

Application

Mounting and Replacing the Pushbutton

(1) Mounting Direction for the Pushbutton/Display and Lamp Lighted Pushbutton Switch

- Insert the Lamp (incandescent lamp or LED lamp) into the Pushbutton so that the lamp guide fits into the wider gap between the projections on the Pushbutton.



Indicator

- With Indicators, the Lamp is inserted facing the opposite direction (i.e., at 180°) to that for Lighted Pushbutton Switches.



Note: Push the projections on the Lamp into the grooves on the Pushbutton/Display. The Lamp for Lighted Pushbutton Switches moves, but the Lamp for Indicators is fixed.

(2) Mounting Direction for the Pushbutton/Display and Switch

- Insert the Pushbutton/Display into the Switch so that the lamp guide is aligned with the non-projecting part of the Switch.
- Apply a pressure between 9.8 and 24.5 N.



- Note: 1. The mounting direction for Indicators is 180° to that for Lighted Pushbutton Switches. Be sure to insert the Legend Plate and other parts with the correct orientation.
 2. If the terminals of the Lamp become bent, it may be impossible to fit them into the lamp terminal holes. Ensure that the terminals are straight when they are inserted.
 3. Take particular care about the mounting direction with the round models (A3CT).

(3) Removing the Pushbutton/Display

Hold the recessed portions on the cap of the Pushbutton and pull.



Note: Do not use tools such as pliers to remove the Pushbutton as this may damage the cap.

Panel Mounting

- Insert the Switch from the front of the panel. Mount the mounting nut from the terminal end of the Switch and tighten it.
- There are projections on the terminal end of the Switch which may, depending on the orientation, block the nut. In this case, turn the nut until it is possible to mount it. Tighten the nut to a torque between 0.20 and 0.39 N-m.
- If soldering is used, mount the mounting nut first. Lead wires and mounds of solder may make it impossible to mount the nut after soldering.



Socket Mounting

- After securing the Switch to the panel using the mounting nut, insert the Socket into the Switch.
- Align the positioning holes of the Socket with the projections of the Switch before inserting the Socket.

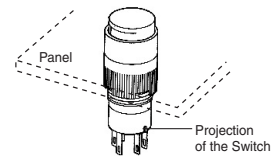

Mounting the Insulation Cover

- After securing the Switch to the panel using the mounting nut, pass the lead wires through the holes in the Insulation Cover and then perform wiring. Hold the Insulation Cover so that the cylindrical hole is facing the Switch, and insert the lead wires from the end with the barriers.
- After wiring is completed, mount the Insulation Cover by pushing it into the Switch.



Mounting the Dust Cover

1. The Dust Cover separates into 2 parts: the cap and the mounting frame.
2. Insert the Switch into the mounting frame. (Align the lock projection with the recess on the mounting frame.)
3. Insert the Switch in the state described in step 2 into the panel. (Align the lock protrusion on the mounting frame with the hole in the panel.)
4. Mount the mounting nut from the back of the panel and tighten it.
5. Insert the cap into the mounting frame. Ensure that the entire perimeter of the cap is properly inserted into the mounting frame by pressing down on the cap from different directions.



Mounting the Switch Guard

1. Insert the Switch into the Switch Guard.
2. Insert the Switch into the panel in the state described in step 1.
3. Mount the mounting nut from the back of the panel and tighten it.



- Application examples provided in this document are for reference only. In actual applications, confirm equipment functions and safety before using the product.
- Consult your OMRON representative before using the product under conditions which are not described in the manual or applying the product to nuclear control systems, railroad systems, aviation systems, vehicles, combustion systems, medical equipment, amusement machines, safety equipment, and other systems or equipment that may have a serious influence on lives and property if used improperly. Make sure that the ratings and performance characteristics of the product provide a margin of safety for the system or equipment, and be sure to provide the system or equipment with double safety mechanisms.

Note: Do not use this document to operate the Unit.

OMRON Corporation

ELECTRONIC AND MECHANICAL COMPONENTS COMPANY

Contact: www.omron.com/ecb

Cat. No. A030-E1-05

0812(0207)(O)



Компания «ЭлектроПласт» предлагает заключение долгосрочных отношений при поставках импортных электронных компонентов на взаимовыгодных условиях!

Наши преимущества:

- Оперативные поставки широкого спектра электронных компонентов отечественного и импортного производства напрямую от производителей и с крупнейших мировых складов;
- Поставка более 17-ти миллионов наименований электронных компонентов;
- Поставка сложных, дефицитных, либо снятых с производства позиций;
- Оперативные сроки поставки под заказ (от 5 рабочих дней);
- Экспресс доставка в любую точку России;
- Техническая поддержка проекта, помощь в подборе аналогов, поставка прототипов;
- Система менеджмента качества сертифицирована по Международному стандарту ISO 9001;
- Лицензия ФСБ на осуществление работ с использованием сведений, составляющих государственную тайну;
- Поставка специализированных компонентов (Xilinx, Altera, Analog Devices, Intersil, Interpoint, Microsemi, Aeroflex, Peregrine, Syfer, Eurofarad, Texas Instrument, Miteq, Cobham, E2V, MA-COM, Hittite, Mini-Circuits, General Dynamics и др.);

Помимо этого, одним из направлений компании «ЭлектроПласт» является направление «Источники питания». Мы предлагаем Вам помощь Конструкторского отдела:

- Подбор оптимального решения, техническое обоснование при выборе компонента;
- Подбор аналогов;
- Консультации по применению компонента;
- Поставка образцов и прототипов;
- Техническая поддержка проекта;
- Защита от снятия компонента с производства.



Как с нами связаться

Телефон: 8 (812) 309 58 32 (многоканальный)

Факс: 8 (812) 320-02-42

Электронная почта: org@eplast1.ru

Адрес: 198099, г. Санкт-Петербург, ул. Калинина, дом 2, корпус 4, литера А.