

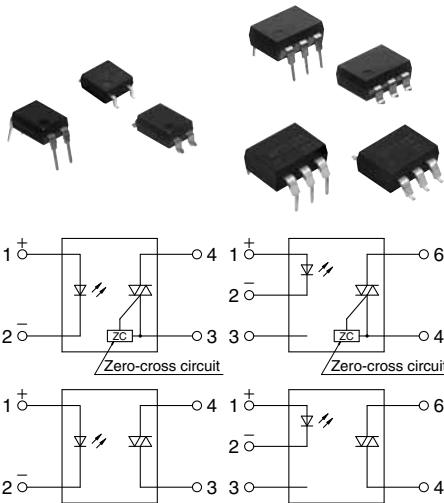

**Phototriac coupler
ideal for triac driver
with wide variation**

APT
Phototriac Coupler



RoHS compliant

FEATURES

- 1. Low zero-cross voltage (max. 15 V) type added to lineup. Approximately 1/3 of previous product**
Helps reduce device noises even further.
- 2. Two types available: Random type and zero-cross type**
- 3. Many package sizes available.** (Wide terminal type with 10.16 mm pitch between I/O terminals available.)
- 4. High dielectric strength.** (Between input and output: SOP 3, 750 V; DIP 5,000 V)
- 5. Handles both 100 and 200 Vrms loads**
This relay handles both voltages in a single product it is not necessary for users that use both types to manage separate part numbers.

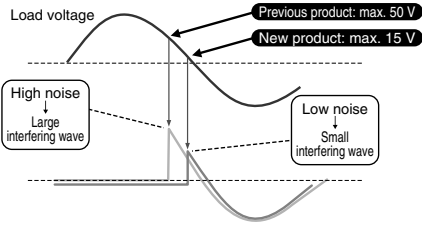

- 6. Terminal 5 of the DIP 6-pin type is completely molded.**
- 7. Complies with safety standards**
SOP4pin:
C-UL (UL1577) Certified
VDE (EN60747-5-5) Certified
DIP4/6pin:
C-UL (UL1577) Certified
VDE (EN60747-5-5) Certified
VDE (EN62368-1) Reinforced insulation certified

TYPICAL APPLICATIONS

- 1. For triac driver in heater controls of products such as office equipment, home appliances, and industrial machines.** (For 100 V/200 V, 50/60 Hz lines)
- 2. Triac driver for SSRs**

ORDERING INFORMATION

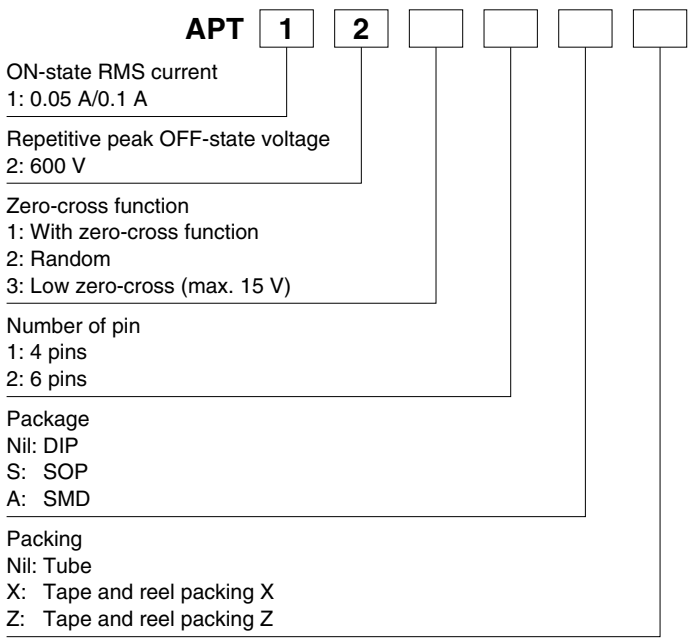

TYPES

1. SOP4 Type

Type	Output rating		Type	Package size	Part No.			Packing quantity	
	Repetitive peak OFF-state voltage	ON-state RMS current			Tube packing style	Tape and reel packing style		Tube	Tape and reel
						Picked from the 1/2-pin side	Picked from the 3/4-pin side		
AC type	600 V	50 mA	Zero-cross (max. 50 V)	SOP4pin	APT1211S	APT1211SX	APT1211SZ	1 tube contains: 100 pcs. 1 batch contains: 2,000 pcs.	1,000 pcs.
			Zero-cross (max. 15 V)		APT1231S	APT1231SX	APT1231SZ		
			Random		APT1221S	APT1221SX	APT1221SZ		

Note: For space reasons, the initial letters of the product number "APT" and "S" are omitted on the product seal.
The package type indicator "X" and "Z" are omitted from the seal. (Ex. the label for product number APT1221SZ is 1221).

2. DIP4/6 Type

Type	Output rating		Type	Package size	Part No.				Packing quantity	
	Repetitive peak OFF-state voltage	ON-state RMS current			Through hole terminal	Surface-mount terminal		Tube	Tape and reel	
						Tube packing style	Tape and reel packing style			
						Picked from the 1/2-pin side 1/2/3-pin side	Picked from the 3/4-pin side 4/6-pin side			
AC type	600 V	100 mA	Zero-cross (max. 50 V)	DIP4pin	APT1211	APT1211A	APT1211AX	APT1211AZ	[DIP4pin] 1 tube contains: 100 pcs. 1 batch contains: 1,000 pcs.	[DIP4pin] [DIP6pin] 1,000 pcs.
			Zero-cross (max. 15 V)		APT1231	APT1231A	APT1231AX	APT1231AZ		
			Random		APT1221	APT1221A	APT1221AX	APT1221AZ		
			Zero-cross (max. 50 V)	DIP6pin	APT1212	APT1212A	APT1212AX	APT1212AZ	[DIP6pin] 1 tube contains: 50 pcs. 1 batch contains: 500 pcs.	
			Zero-cross (max. 15 V)		APT1232	APT1232A	APT1232AX	APT1232AZ		
			Random		APT1222	APT1222A	APT1222AX	APT1222AZ		

Note: For space reasons the initial letters "APT" of the product number for the DIP 4-pin type, the letter "A", which indicates the SMD terminal shape for the DIP 4-pin and 6-pin types, and the package type indications "X" and "Z" have been omitted from the product label. (Example: The label for product number APT1221AZ is 1221.)

3. DIP6 Wide Terminal Type

Type	Output rating*		Type	Package size	Part No.				Packing quantity	
	Repetitive peak OFF-state voltage	ON-state RMS current			Through hole terminal	Surface-mount terminal		Tube	Tape and reel	
						Tube packing style	Tape and reel packing style			
						Picked from the 1/6-pin side	Picked from the 3/4-pin side			
AC type	600 V	100 mA	Zero-cross (max. 50 V)	DIP6pin	APT1212W	APT1212WA	APT1212WAY	APT1212WAW	1 tube contains: 50 pcs. 1 batch contains: 500 pcs.	1,000 pcs.
			Zero-cross (max. 15 V)		APT1232W	APT1232WA	APT1232WAY	APT1232WAW		
			Random		APT1222W	APT1222WA	APT1222WAY	APT1222WAW		

Note: For space reasons the initial letters the letter "WA", which indicates the SMD terminal shape for the DIP 6-pin types, and the package type indications "Y" and "W" have been omitted from the product label. (Example: The label for product number APT1212WAY is 1212.)

RATING

1. Absolute maximum ratings (Ambient temperature: 25°C 77°F)

1) SOP4 types

Item		Symbol	APT1211S, APT1221S, APT1231S	Remarks
Input	LED forward current	I _F	50 mA	
	LED reverse voltage	V _R	6 V	
	Peak forward current	I _{FP}	1 A	f = 100 Hz, Duty Ratio = 0.1%
Output	Repetitive peak OFF-state voltage	V _{DRM}	600 V	
	ON-state RMS current*	I _{T(RMS)}	0.05 A	AC
	Non-repetitive surge current	I _{TSM}	0.6 A	In one cycle at 60 Hz
Total power dissipation		P _T	350 mW	
I/O isolation voltage		V _{iso}	3,750 Vrms	
Temperature limits	Operating	T _{opr}	-40 to +100°C -40 to +212°F	Non-condensing at low temperatures
	Storage	T _{stg}	-40 to +125°C -40 to +257°F	

Note: "X" and "Z" at the end of the part numbers have been omitted.

2) DIP4/6 type and DIP6 Wide terminal type

Item		Symbol	APT1211, APT1221, APT1231, APT1212(W), APT1222(W), APT1232(W)	Remarks
Input	LED forward current	I _F	50 mA	
	LED reverse voltage	V _R	6 V	
	Peak forward current	I _{FP}	1 A	f = 100 Hz, Duty Ratio = 0.1%
Output	Repetitive peak OFF-state voltage	V _{DRM}	600 V	
	ON-state RMS current*	I _{T(RMS)}	0.1 A	AC
	Non-repetitive surge current	I _{TSM}	1.2 A	In one cycle at 60 Hz
Total power dissipation		P _T	500 mW	
I/O isolation voltage		V _{iso}	5,000 Vrms	
Temperature limits	Operating	T _{opr}	-40 to +100°C -40 to +212°F	Non-condensing at low temperatures
	Storage	T _{stg}	-40 to +125°C -40 to +257°F	

Note: "A", "AX", "AZ" "AY" and "AW" at the end of the part numbers have been omitted.

* Do not exceed 0.05 A of ON state RMS current in case of following load voltage condition.

DIP4pin (APT1211, APT1221, APT1231): more than 100 Vrms;

DIP6pin (APT1212, APT1222, APT1232) and DIP6pin wide terminal type (APT1212W, APT1222W, APT1232W): more than 120 Vrms.

2. Characteristics (Ambient temperature: 25°C 77°F)

1) Zero-cross type (max. 50 V) and random type

Item		Symbol	APT1211S, APT1211, APT1212(W)	APT1221S, APT1221, APT1222(W)	Condition
Input	LED dropout voltage	Typical	1.21 V		$I_F = 20 \text{ mA}$
		Maximum	1.3 V		
	LED reverse current	Typical	—		$V_R = 6 \text{ V}$
		Maximum	10 μA		
Output	Repetitive peak OFF-state current	Typical	—		$I_F = 0 \text{ mA}$ $V_{DRM} = 600 \text{ V}$
		Maximum	1 μA		
	Repetitive peak On-state voltage	Typical	1.3 V		$I_F = 10 \text{ mA}$ $I_{TM} = 0.05 \text{ A}$
		Maximum	2.5 V		
Holding current	Typical	0.3 mA			
	Maximum	3.5 mA			
	Critical rate of rise of OFF-state voltage	Minimum	500 V/ μs		$V_{DRM} = 600 \text{ V} \times 1/\sqrt{2}$
Transfer characteristics	Trigger LED current	Maximum	10 mA		$V_D = 6 \text{ V}$ $R_L = 100 \Omega$
	Zero-cross voltage	Maximum	50 V	—	$I_F = 10 \text{ mA}$
	Turn on time*	Maximum	100 μs		$I_F = 20 \text{ mA}$ $V_D = 6 \text{ V}$ $R_L = 100 \Omega$
	I/O capacitance	Maximum	1.5 pF		$f = 1 \text{ MHz}$ $V_B = 0 \text{ V}$
	I/O isolation resistance	Minimum	50 G Ω		500 V DC

Note: 1. For type of connection, see "SCHEMATIC AND WIRING DIAGRAMS".

*Turn on time



2) Zero-cross type (max. 15 V)

Item		Symbol	APT1231S, APT1231, APT1232(W)		Condition
Input	LED dropout voltage	Typical	1.21 V		$I_F = 20 \text{ mA}$
		Maximum	1.3 V		
	LED reverse current	Typical	—		$V_R = 6 \text{ V}$
		Maximum	10 μA		
Output	Repetitive peak OFF-state current	Typical	—		$I_F = 0 \text{ mA}$ $V_{DRM} = 600 \text{ V}$
		Maximum	1 μA		
	Repetitive peak On-state voltage	Typical	1.2 V		$I_F = 10 \text{ mA}$ $I_{TM} = 0.03 \text{ A}$
		Maximum	2 V		
Holding current	Typical	0.3 mA			
	Maximum	3.5 mA			
	Critical rate of rise of OFF-state voltage	Minimum	500 V/ μs		$V_{DRM} = 600 \text{ V} \times 1/\sqrt{2}$
Transfer characteristics	Trigger LED current	Maximum	10 mA		$I_{TM} = 0.03 \text{ A}$
	Zero-cross voltage	Maximum	15 V		$I_F = 10 \text{ mA}$
	Turn on time*	Maximum	100 μs		$I_F = 20 \text{ mA}$ $I_{TM} = 0.03 \text{ A}$
	I/O capacitance	Maximum	1.5 pF		$f = 1 \text{ MHz}$ $V_B = 0 \text{ V}$
	I/O isolation resistance	Minimum	50 G Ω		500 V DC

Note: 1. For type of connection, see "SCHEMATIC AND WIRING DIAGRAMS".

*Turn on time



RECOMMENDED OPERATING CONDITIONS

Please use under recommended operating conditions to obtain expected characteristics.

Item	Symbol	Min.	Max.	Unit
Input LED current	I_F	15	25	mA

REFERENCE DATA

1-(1). ON-state RMS current vs. ambient temperature characteristics

Allowable ambient temperature: -40 to +100°C
-40 to +212°F

Tested sample: APT1211S, APT1221S



1-(2). ON-state RMS current vs. ambient temperature characteristics

Allowable ambient temperature: -40 to +100°C
-40 to +212°F

Tested sample: APT1231S



1-(3). ON-state RMS current vs. ambient temperature characteristics

Allowable ambient temperature: -40 to +100°C
-40 to +212°F

Tested sample: APT1211(A), APT1221(A)



1-(4). ON-state RMS current vs. ambient temperature characteristics

Allowable ambient temperature: -40 to +100°C
-40 to +212°F

Tested sample: APT1231(A)



1-(5). ON-state RMS current vs. ambient temperature characteristics

Allowable ambient temperature: -40 to +100°C
-40 to +212°F

Tested sample: APT1212(A), APT1222(A),
APT1212W(A), APT1222W(A)



1-(6). ON-state RMS current vs. ambient temperature characteristics

Allowable ambient temperature: -40 to +100°C
-40 to +212°F

Tested sample: APT1232(A), APT1232W(A)



2. On voltage vs. ambient temperature characteristics



3. Trigger LED current vs. ambient temperature characteristics



4. LED dropout voltage vs. ambient temperature characteristics



5. Turn on time vs. LED current characteristics



6. Repetitive peak OFF-state current vs. Load voltage characteristics



7. Hold current vs. ambient temperature characteristics



8. Zero-cross voltage vs. ambient temperature characteristics



DIMENSIONS (mm inch)

The CAD data of the products with a **CAD** mark can be downloaded from: <https://industrial.panasonic.com/ac/e/>

1. SOP Type

APT1211S, APT1221S, APT1231S

CAD



External dimensions



Recommended mounting pad (TOP VIEW)



Tolerance: $\pm 0.1 \pm 0.004$

Terminal thickness = 0.15 ± 0.006

General tolerance: $\pm 0.1 \pm 0.004$

2. DIP4 Type

APT1211(A), APT1221(A), APT1231(A)

CAD



External dimensions

Through hole terminal type



Surface mount terminal type



Terminal thickness = 0.20 ± 0.008

General tolerance: $\pm 0.1 \pm 0.004$

PC board pattern (BOTTOM VIEW)

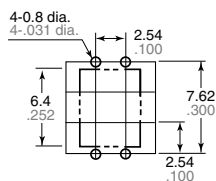

Tolerance: $\pm 0.1 \pm 0.004$

Recommended mounting pad (TOP VIEW)

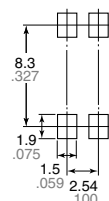

Tolerance: $\pm 0.1 \pm 0.004$

3. DIP6 Type

APT1212(A), APT1222(A), APT1232(A)

CAD



External dimensions

Through hole terminal type



Surface mount terminal type



Terminal thickness = 0.25 ± 0.010
 General tolerance: $\pm 0.1 \pm 0.004$

PC board pattern (BOTTOM VIEW)



Tolerance: $\pm 0.1 \pm 0.004$

Recommended mounting pad (TOP VIEW)



Tolerance: $\pm 0.1 \pm 0.004$

4. DIP6 Wide Terminal Type

APT1212W(A), APT1222W(A), APT1232W(A)

CAD



External dimensions

Through hole terminal type



Surface mount terminal type



PC board pattern (BOTTOM VIEW)

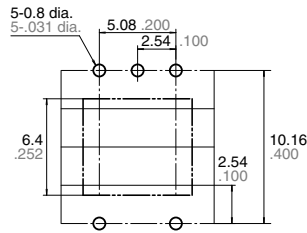

Recommended mounting pad (TOP VIEW)

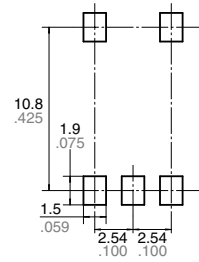

Tolerance: ±0.1 ±.004

Tolerance: ±0.1 ±.004

SCHEMATIC AND WIRING DIAGRAMS

Schematic	Output configuration	Load	Wiring diagram
<p>Zero-cross circuit</p>	1 Form A	AC	<p>Power source at input side</p>
			<p>Power source at input side</p>
<p>Zero-cross circuit</p>			<p>Power source at input side</p>
			<p>Power source at input side</p>

Please contact

Panasonic Corporation

Electromechanical Control Business Division

■ 1006, Oaza Kadoma, Kadoma-shi, Osaka 571-8506, Japan
industrial.panasonic.com/ac/e/

Panasonic[®]

©Panasonic Corporation 2018

Mouser Electronics

Authorized Distributor

Click to View Pricing, Inventory, Delivery & Lifecycle Information:

Panasonic:

[APT1211](#) [APT1211AX](#) [APT1211AZ](#) [APT1211SX](#) [APT1211SZ](#) [APT1211W](#) [APT1211WA](#) [APT1211WAW](#)
[APT1211WAY](#) [APT1212A](#) [APT1212AX](#) [APT1212AZ](#) [APT1212W](#) [APT1212WA](#) [APT1212WAW](#) [APT1212WAY](#)
[APT1221AX](#) [APT1221AZ](#) [APT1221SX](#) [APT1221SZ](#) [APT1221W](#) [APT1221WA](#) [APT1221WAW](#) [APT1221WAY](#)
[APT1222A](#) [APT1222AX](#) [APT1222AZ](#) [APT1222W](#) [APT1222WA](#) [APT1222WAW](#) [APT1222WAY](#) [APT1232A](#)
[APT1212D05](#) [APT1222D05](#)



Компания «ЭлектроПласт» предлагает заключение долгосрочных отношений при поставках импортных электронных компонентов на взаимовыгодных условиях!

Наши преимущества:

- Оперативные поставки широкого спектра электронных компонентов отечественного и импортного производства напрямую от производителей и с крупнейших мировых складов;
- Поставка более 17-ти миллионов наименований электронных компонентов;
- Поставка сложных, дефицитных, либо снятых с производства позиций;
- Оперативные сроки поставки под заказ (от 5 рабочих дней);
- Экспресс доставка в любую точку России;
- Техническая поддержка проекта, помощь в подборе аналогов, поставка прототипов;
- Система менеджмента качества сертифицирована по Международному стандарту ISO 9001;
- Лицензия ФСБ на осуществление работ с использованием сведений, составляющих государственную тайну;
- Поставка специализированных компонентов (Xilinx, Altera, Analog Devices, Intersil, Interpoint, Microsemi, Aeroflex, Peregrine, Syfer, Eurofarad, Texas Instrument, Miteq, Cobham, E2V, MA-COM, Hittite, Mini-Circuits, General Dynamics и др.);

Помимо этого, одним из направлений компании «ЭлектроПласт» является направление «Источники питания». Мы предлагаем Вам помощь Конструкторского отдела:

- Подбор оптимального решения, техническое обоснование при выборе компонента;
- Подбор аналогов;
- Консультации по применению компонента;
- Поставка образцов и прототипов;
- Техническая поддержка проекта;
- Защита от снятия компонента с производства.



Как с нами связаться

Телефон: 8 (812) 309 58 32 (многоканальный)

Факс: 8 (812) 320-02-42

Электронная почта: org@eplast1.ru

Адрес: 198099, г. Санкт-Петербург, ул. Калинина, дом 2, корпус 4, литера А.