

# Amphenol

## 162GB Series

Miniature Bayonet Lock Connectors



### CONTENTS

	Pages
• <b>Introduction to 162GB Crimp Connectors</b>	2
• Audio Applications	2
• Cable Assembly Facilities at Amphenol Ltd	2
• MIL-C-26482 Qualification Approval Tests	3-4
• DEF 5325 Qualification Approval Tests	5
• Table of Shell Styles	6-7
• Insert Availability and Voltage Ratings	8
• How to Order 162GB Crimp Connectors	9-10
• Box Mounting Receptacles	11-12
• Single Hole Fixing Receptacles	13-14
• Cable Mounting Receptacles	15-16
• Plugs	17-18
• Plugs with optional Coupling Rings	19
• Cable Accessories	20
• Cables to DEF 10	21-28
• Accessories	29-31
• Dust Caps	32-33
• AIA Backshells – Interconnection Accessories	34
• Interconnection Accessories Installation Procedure	35
• Interconnection Accessories Shield Term Process	36
• Key/keyway Orientations	37-42
• Insert Orientations	
• 162GB Crimp Assembly Instructions	



# Amphenol 162GB Crimp Connectors

DESIGNED TO COMPLY WITH MIL-C-26482  
AND BS 9522-N0001, THE SUCCESSOR TO  
DEF 5326 Patt. 603

Development and manufacture of 162GB miniature bayonet lock connectors has been closely coordinated with the solder version. The entire programme has been carried out at Amphenol's Whitstable Plant. The precision machinery and measurement control processes used for the production of 162GB crimp connectors are the same as those used to produce 62GB solder connectors.

Full intermountability and intermateability are absolutely guaranteed.

162GB Series crimp connectors share many of the features of 62GB solder connectors. Coupling is achieved with a triple-track bayonet locking system which gives positive alignment on all shell sizes. When connector halves are fully mated there is a definite click. Inspection holes in the coupling ring will then reveal the bayonet pins on the receptacle which are clearly marked in yellow.

The Amphenol design means simplified removal of coupling rings for servicing or replacement as they are *front demountable*. In addition there is a rough grip heavy duty style for arduous conditions and a lever coupling ring which allows extremely close mounting of connectors.

The method of sealing is the same as for 62GB connectors; using peripheral seals on the rubber inserts and sealing the mating shells with a square section gasket. Wire sealing is by multiple risers in the rear grommet.

## Derating

Connectors must be derated under the following operating temperatures:

1. At elevated temperatures, the current ratings are reduced as show in the table on page 10.
2. At high altitudes, revised voltage ratings become effective as shown on page 11.
3. When connectors to different specifications are intermated (e.g. BS 9522-N001 and MIL-C-26482), the combination must not be operated under conditions more severe than the less stringent clause of either specification.

*Amphenol 162GB connectors are designed to meet the most stringent requirements of both specifications.*

## Audio Applications

Contacts are suitable for tinsel cord applications.



## Cable Assemblies

Amphenol is fully equipped to undertake the preparation of all types of cable assemblies complying with the military vehicles and engineering establishments and fighting vehicles requirements of the Ministry of Defence – the Ministry of Environment (Motorways) for motorway control equipment – the Post Office manufacturing code and to the British Standards Institute when applicable to Cable systems. Control procedures carried out in accordance with MIN DEF 05-21. Approval numbers BS 9000, 1043/M and CAA AD/1450/58. Moulded terminations form a specialised service by the company. The process offers such advantages as a waterproof seal between cable and connector back-end, mechanical protection, and a homogeneous joint between moulding and cable.

## Other Amphenol Products

Amphenol products include: printed circuit, rack and panel, microminiature, audio; hermetic and R.F. connectors; integrated circuit components; trimming and precision potentiometers; concentric and digital microdials; cable, cable assemblies; fans and blowers; relays and keys; chokes and coils; R.F. coaxial switches.

# Amphenol 162GB Series

DESIGNED TO COMPLY WITH MIL-26482  
SCHEDULE OF TESTS REQUIRED FOR  
QUALIFICATION APPROVAL

Tests	Brief Description												
<b>Examination of Product</b>													
Maintenance Ageing	Crimp only There is no damage to the contacts or connectors after 10 removals and insertions of the contacts												
Contact Insertion and Removal Forces	Crimp only Insertion – does not exceed 66.7 N (15lbf.) For individual contacts. Removal – does not exceed 44.5N (10lbf.)												
Contact Retention	Crimp Contact Contact locking mechanisms withstands the following minimum axial forces: <table border="1" style="margin-left: 40px;"> <tr> <td>CONTACT SIZE</td> <td>20</td> <td>16</td> <td>12</td> </tr> <tr> <td>FORCE (N)</td> <td>89</td> <td>111</td> <td>133</td> </tr> <tr> <td>FORCE (LBF)</td> <td>20</td> <td>25</td> <td>30</td> </tr> </table> <p>Axial displacement does not exceed 0.304mm (0.012in) when pressure is applied from face side.</p>	CONTACT SIZE	20	16	12	FORCE (N)	89	111	133	FORCE (LBF)	20	25	30
CONTACT SIZE	20	16	12										
FORCE (N)	89	111	133										
FORCE (LBF)	20	25	30										
Operating Forces	Torque measurement of mating and unmating. Ranges from 0.905 Nm. (8 lbf. in.) on shell size 8 to 4.971 Nm. (44 lbf. in.) on shell size 24 couplings.												
Insulation Resistance, Room Temperature	Unmated connectors tested in accordance with Method 302 test condition B of MIL-STD-202.												
Dielectric Withstanding Voltage (Sea Level)	Mated and unmated connectors tested in accordance with Method 301 of MIL-STD-202.												
Dielectric Withstanding Voltage (Altitude)	Tested in accordance with Method 105, test condition C of MIL-STD-202. After 30 minutes tested in accordance with Method 301 of MIL-STD-202 unmated and mated.												
Initial Contact Resistance	Between 45 and 95 millivolts drop on wire sizes from 24 to 12. Crimp contacts to meet MIL-C-23216.												
Thermal Shock	Unmated connectors tested in accordance with Method 107, condition B of MIL-STD-202 except min. temp is –55°C.												
Insulation Resistance at Elevated Temps (Short Time)	Greater than 3 megohms 250 hr at 125°C												
(Long Time)	Greater than 12 megohms 1000 hr at 105°C												
Durability	500 cycles of coupling and uncoupling												
Vibration	In accordance with Method 204 Condition B of MIL-STD-202												
Shock	Impulses of 50 G's duration of 11 ±1 milliseconds												
Moisture Resistance	In accordance with Method 106 of MIL-STD-202												
Corrosion	Salt Spray to Method 101 Condition B of MIL-STD-202												
Operating Forces	From 0.905 Nm. (8 lb. In.) for shell size 8 to 4.971 Nm. (44 lb. in.) for shell size 24.												
Contact Resistance	As per contact resistance test of MIL-C-23216.												
(a) Solvent Immersion Hydraulic Fluid	Conforming to MIL-H-5606 20 hrs												
(b) Solvent Immersion Lubricating Oil	Conforming to MIL-H-7808 20 hrs												
Insert Retention	Effective pressure differential of 5 17.0 KN/m <sup>2</sup> (75 p.s.i.)												
Insert Retention Hermetic	Effective pressure differential of 13 80.0 KN/m <sup>2</sup> 200 (p.s.i.)												
Contact Retention Crimp	Axial loads between 6 6.67 N (15 lbf.) and 111.2 N (25 lbf.)												

Protective Covers and Storage	
Tests	Brief Description
<b>Examination of Product</b>	<b>Components suitability after storage and use of recommended Protective Covers</b>
Operating Forces	Measurement of Receptacles, Plugs and Protective Covers mating and unmating forces.
Moisture Resistance	Crimp Contacts to Method 106 of MIL-STD-202.
Corrosion	Salt Spray to Method 101, Condition B of MIL-STD-202.
Cover Chains Tensile Strength	111.2 N (25 lbf.) from various directions
Air Leakage	69.0 KN/m <sup>2</sup> (10 p.s.i.) applied to inside of Protective Covers

Crimp Contact Retention Feature	
Tests	Brief Description
<b>Examination of Product</b>	<b>Test to establish Crimp effectiveness</b>
Maintenance Ageing (Contacts only)	Involves repeated insertion/removal of contacts and mating and unmating of connectors.
Contact Retention	Loads applied in both directions.

Connector Assembly – Class J	
Tests	Brief Description
<b>Examination of Product</b>	
Thermal Shock	In accordance with Method 107 Condition B of MIL-STD-202
Water Pressure	Immersion 1.829 m (6 ft.) under water for solder type connectors
Air Leakage	Solder Receptacles 206.9 KN/m <sup>2</sup> (30 p.s.i.) across connectors. Others to Method 112 Condition C, Procedure 1 of MIL-STD-202

# Table of Shell Styles

	BOX MOUNTING RECEPTACLES (4-hole Fixing) Page	BOX MOUNTING RECEPTACLES (4-hole Fixing) Page	SINGLE HOLE FIXING RECEPTACLES Page
<b>PLAIN SHELL</b>		 162GB 12E	
<b>THREADED SHELL</b>	 162GB 30T		 162GB 37T
<b>GROMMET SEAL</b>	 162GB 10E		 162GB 14E
<b>STRAIN RELIEF CLAMP</b> (For details of Right Angle Strain Relief Clamps, see Page 20)	 162GB 10F		 162GB 14F

	CABLE MOUNTING RECEPTACLES Page	NON GROUNDED PLUGS Page	GROUNDED PLUGS Page
<b>THREADED SHELL</b>	 162GB 31T	 162GB 36T	 162GB 36TG
<b>GROMMET SEAL</b>	 162GB 11E	 162GB 16E	
<b>STRAIN RELIEF CLAMP</b> (For details of Right Angle Strain Relief Clamps, see Page 20)	 162GB 11F	 162GB 16F	

# Insert Availability

8	10	12	14	16	18	20
8-03 	10-06 	12-10 	14-12† 	16-23* 	18-32 	20-41 
8-33 	10-07 	12-08 	14-15 	16-26 		
8-98 			14-19 			
	10-02 	12-03 	14-05 	16-08 	18-11 	20-16 
				16-04 		

## Notes

\* These insert arrangements are not included in Pattern 105 but are available and listed in MIL-C-26482.

† Due to the arrangement of contacts in the 14-12 insert arrangement it is classified, for current derating, in the shell size range 18-24.

Lettering of inserts shown above corresponds to views of front (mating) surface of pin inserts or rear face (cable accessory end) of socket inserts.

KEY ? No. 16 size contacts  
 ? No. 20 size contacts  
 No. 12 size contacts



# Insert Availability



Working Voltage			
Altitude	dc Working Voltage	ac Working Voltage r.m.s.	Proof Voltage
<b>Rating 1</b>			
Sea Level	<b>700</b>	<b>500</b>	<b>500</b>
300mb at 20°C 8.500m (27,800 ft)	375	265	265
44 mb at 20°C 20,000 m (66,000 ft)	200	140	140
<b>Rating 2</b>			
Sea Level	<b>1250</b>	<b>900</b>	<b>3250</b>
300mb at 20°C 8.500m (27,800 ft)	550	390	1750
44 mb at 20°C 20,000 m (66,000 ft)	300	210	775
<b>Rating 3</b>			
	<b>Sea Level 1013 mbart</b>	<b>8500m (27,900 ft) 320 mbar</b>	<b>21,340m (70,000 ft) 44 mbart</b>
<b>Working Voltage</b>	III	III	III
<b>Working Voltages ** (nominal) d.c. or a.c. peak</b>	1500	800	450
<b>Voltage Proof d.c. or a.c. peak</b>	3000	1300	750

(Figures in bold type are from DEF STAN 59-35 (Part 1) Sec. 3 Patt. 105)



## NOTES

Because safe working voltages at altitude above sea-level are dependent upon individual conditions of use, these values are not specified in DEF STAN 59-35 (Part 1) Sec. 3 Patt. 105 but approximate values are included here for the guidance of designs.

## VOLTAGE RATINGS

Two categories of voltage rating are specified in DEF STAN 59-35 (Part 1) Sec. 3 Patt. 105.

### Rating 1 (700V d.c. working at sea-level)

Applicable to the high contact density inserts shown in the upper section of the insert availability diagram above.

### Rating 2 (1250V d.c. working at sea-level)

Applicable to the inserts shown in the lower section of the insert availability diagram.

### Rating 3 (1500V d.c. working at sea-level)

- (a) Maximum current per individual contact (in isolation)\* at ambient temperature of 85°C  
Contact Size 12: 23A
- (b) Maximum current per contact through all contacts simultaneously at an ambient temperature of 85°C  
Contact Size 12: 20A

## Altitude Derating

Information on voltage derating for operation at altitudes above sea-level can be obtained from the flashover voltage altitude curves on the left.

# Ordering Amphenol 162GB Series Connectors



## HOW TO ORDER FROM MS CONNECTOR NUMBERS

Connector numbers in the AMPHENOL and MS numbering systems. Only alternative insert orientations are specified in MIL-C-26482 which does not include alternative key/keyway orientations

<b>MS31</b>	-	<b>24</b>	<b>E</b>	<b>18-11</b>	<b>P</b>	<b>X</b>
<b>162GB</b>	-	<b>14</b>	<b>E</b>	<b>18-11</b>	<b>P</b>	<b>X</b>



# Box Mounting Receptacles

		Description	Amphenol Part No	Military No
	<b>30T</b>	4-hole flange mounting with threaded shell to accept standard cable accessories	<b>162 Series</b> 162GB-30T etc	
	<b>10E</b>	4-hole flange mounting with grommet and grommet nut	<b>162 Series</b> 162GB-10E etc	MS3120E etc
	<b>10F</b>	4-hole flange mounting with grommet and grommet nut fitted with integral strain relief clamp	<b>162 Series</b> 162GB-10F etc	MS 3120F etc
	<b>12E</b>	4-hole flange mounting with plain shell for direct wiring to exposed solder buckets. Film wire terminations available on 62 Series as deviation (219). 162 Series style has integral grommet	<b>162 Series</b> 162GB-12E etc	MS 3122E etc

# Dimensions and Mounting Details

## 162 OVERALL MATED DIMENSIONS



Add the two relevant plug and receptacle overall dimensions and deduct:

- 0.365 (9.271mm) for shell sizes 20, 22, 24
- 0.303 (7.696mm) for all other sizes

Panel



← W

When receptacles are mounted on the rear face of the panel, the maximum value for dimension W must not be exceeded otherwise the receptacle cannot be mated to a plug

Panel thickness with screw head W max.

Shell Size	in mm	Shell Size	in mm
08-18	0.100	20-24	0.210
	2.540		5.330

Shell Size	'A' Overall Length Max				'L' Shell Lengths
	30T in mm	(162) 10E in mm	(162) 10F in mm	(162) 12E in mm	(162) 12E in mm
08	1.286	1.320	1.759	1.286	0.917
	32.665	33.53	44.68	32.665	23.29
10	1.286	1.320	1.759	1.286	0.917
	32.665	33.53	44.68	32.665	23.29
12	1.286	1.320	1.759	1.286	0.917
	32.665	33.53	44.68	32.665	23.29
14	1.286	1.320	1.733	1.286	0.917
	32.665	33.53	44.02	32.665	23.29
16	1.286	1.320	1.873	1.286	0.917
	32.665	33.53	47.575	32.665	23.29
18	1.286	1.320	1.873	1.286	0.917
	32.665	33.53	47.575	32.665	23.29
20	1.348	1.382	2.115	1.348	0.980
	34.24	35.10	53.72	34.24	24.89
22	1.348	1.382	2.115	1.348	0.980
	34.24	35.10	53.72	34.24	24.89
24	1.348	1.382	2.247	1.348	1.023
	34.24	35.10	57.075	34.24	29.895

Shell Size	Flange thickness ±0.005 (±0.127)	Flange dim. max. sq.	Flange hole centres TP	Flange holes dia. ±0.005 (±0.127) -0.002 (-0.051)	Mtg. Flange location ±0.005 (±0.127)	Overall Rear dia. max.				Cable sleeve int. dia. ±0.005 (±0.127)	Thread	Shell ext. dia. Max.
	B	C	D	E	F	30T	12E	10E	10F	H	X	Y
	in mm	in mm	in mm	in mm	in mm	in mm	in mm	in mm	in mm	in mm	in mm	in mm
08	0.062	0.817	0.594	0.120	0.445	0.434	0.434	0.561	0.828	0.156	7/16-28 UNEF	0.473
	1.575	20.75	15.09	3.05	11.3	11.02	11.02	14.25	21.03	3.96		12.015
10	0.062	0.942	0.719	0.120	0.445	0.558	0.558	0.686	0.891	0.188	9/16-24 NEF	0.590
	1.575	23.925	18.26	3.05	11.3	14.17	14.17	17.425	22.63	4.775		14.99
12	0.062	1.036	0.812	0.120	0.445	0.683	0.683	0.811	1.016	0.312	11/16-24 NEF	0.750
	1.575	26.315	20.625	3.05	11.3	17.35	17.35	20.60	25.805	7.925		19.05
14	0.062	1.130	0.906	0.120	0.445	0.808	0.808	0.936	1.141	0.375	13/16-20 UNEF	0.875
	1.575	28.70	23.10	3.05	11.3	20.52	20.52	23.775	28.98	9.575		22.225
16	0.062	1.223	0.969	0.120	0.445	0.933	0.933	1.061	1.203	0.500	15/16-20 UNEF	1.000
	1.575	31.065	24.61	3.05	11.30	23.70	23.70	26.975	30.555	12.7		25.4
18	0.062	1.317	1.062	0.120	0.445	1.057	1.057	1.186	1.426	0.625	1 1/16-18 NEF	1.125
	1.575	33.45	26.575	3.05	11.3	26.85	26.85	30.12	36.22	15.875		28.575
20	0.080	1.442	1.156	0.120	0.555	1.182	1.182	1.311	1.426	0.625	1 3/16-18 NEF	1.250
	2.03	36.625	29.36	3.05	14.095	30.02	30.02	33.30	36.22	15.875		31.75
22	0.080	1.567	1.250	0.120	0.555	1.307	1.307	1.436	1.567	0.750	1 5/16-18 NEF	1.375
	2.03	39.80	31.75	3.05	14.095	33.20	33.20	36.47	39.80	19.05		34.925
24	0.080	1.692	1.375	0.147	0.590	1.432	1.432	1.561	1.735	0.800	1 7/16-18 NEF	1.500
	2.03	42.98	34.925	3.735	14.985	36.37	36.37	39.65	44.07	20.32		38.1

# Single Hole Fixing Receptacles

		Description	Amphenol Part No	Military No
	<p><b>14E</b></p>	<p>Single hole fixing with grommet and grommet nut. Has panel O-ring seal</p>	<p><b>162 Series</b> 162GB-14E etc</p>	
	<p><b>14F</b></p>	<p>Single hole fixing with grommet and grommet nut fitted with integral strain relief clamp. Has panel O-ring seal</p>	<p><b>162GB Series</b> 162GB-14F etc</p>	
	<p><b>37T</b></p>	<p>Single hole fixing with threaded shell to accept accessories</p>	<p><b>162GB Series</b> 162GB-37T etc</p>	

# Dimensions and Mounting Details

## 162 OVERALL MATED DIMENSIONS

Add the two relevant plug and receptacle overall dimensions and deduct -

- 0.365 (9.271mm) for shell sizes 20, 22, 24
- 0.303 (7.696mm) for all other sizes



## SINGLE HOLE FIXING RECEPTACLES PANEL PIERCING DETAILS

Shell Size	Mounting hole dia. 0.005 (±0.127)	Mounting hole crs. min.	Diameter across flat 0.005 (±0.127)	Panel Thickness	
				Min.	Max.
				K in mm	
	R in mm	S in mm	N in mm		
8	0.572	1.250	0.540	0.062	0.125
	14.53	31.75	13.72	1.575	3.175
10	0.697	1.359	0.665	0.062	0.125
	17.70	34.53	16.89	1.575	3.175
12	0.885	1.531	0.828	0.062	0.125
	22.48	38.885	21.03	1.575	3.175
14	1.010	1.656	0.952	0.062	0.125
	25.65	42.06	24.18	1.575	3.175
16	1.135	1.781	1.076	0.062	0.125
	28.83	45.24	27.33	1.575	3.175
20	1.260	1.891	1.201	0.062	0.125
	32.00	48.03	30.50	1.575	3.175
20	1.385	2.031	1.326	0.062	0.250
	35.18	51.59	33.68	1.575	6.35
22	1.510	2.156	1.451	0.062	0.250
	38.35	54.76	36.855	1.575	6.35
24	1.635	2.277	1.576	0.062	0.250
	41.45	57.835	40.03	1.575	6.35

Shell Size	Overall Length Max. A	
	(162)	(162)
	14E in mm	14F in mm
8	1.355	1.759
	34.42	44.68
10	1.355	1.759
	34.42	44.68
12	1.355	1.759
	34.42	44.68
14	1.355	1.733
	34.42	44.02
16	1.355	1.873
	34.42	44.575
18	1.355	1.873
	34.42	44.575
20	1.576	2.105
	40.03	53.47
22	1.576	2.105
	40.03	53.47
24	1.609	2.247
	40.87	57.075

Shell Size	Flange thick-ness ±0.005 (±0.127)		Mtg. Flange location ±0.005 (±0.127)		Overall Rear diameter		Cable Sleeve int. dia. ±0.005 (±0.127)	Fixing Nut A/F	Fixing nut thread	Thread flat +0.000 -0.005 (-0.127)	Shell Ext dia. Max.		
	B	F	G		H	L						M	Y
	14E 14F in mm	in mm	14E in mm	14F in mm	14F in mm	in mm						in mm	in mm
08	0.117	0.706	0.713	0.828	0.156	0.750	0.156	0.750	<sup>9</sup> / <sub>16</sub> -24 NEF	0.527	0.473		
	2.97	17.93	18.11	21.03	3.96	19.05	3.96	19.05		13.3	12.025		
10	0.117	0.706	0.838	0.891	0.188	0.875	0.188	0.875	<sup>11</sup> / <sub>16</sub> -24 NEF	0.652	0.590		
	2.97	17.93	21.29	22.63	4.775	22.225	4.775	22.225		16.56	14.99		
12	0.117	0.706	0.963	1.016	0.312	1.062	0.312	1.062	? - 20 UNEF	0.815	0.750		
	2.97	17.93	24.46	25.805	7.925	26.975	7.925	26.975		20.70	19.05		
14	0.117	0.706	1.088	1.141	0.375	1.187	0.375	1.187	1-20 UNEF	0.939	0.875		
	2.97	17.93	27.625	28.97	9.525	30.15	9.525	30.15		23.85	22.225		
16	0.117	0.706	1.213	1.203	0.500	1.312	0.500	1.312	1? -18 NEF	1.063	1.000		
	2.97	17.93	30.81	30.555	12.7	33.32	12.7	33.32		27.00	25.40		
18	0.117	0.706	1.338	1.426	0.625	1.437	0.625	1.437	1¼ -18 NEF	1.188	1.125		
	2.97	17.93	33.975	36.22	15.875	36.50	15.875	36.50		30.175	28.575		
20	0.148	0.894	1.463	1.426	0.625	1.562	0.625	1.562	1? -18 NEF	1.313	1.250		
	3.76	22.71	37.16	36.22	15.875	38.675	15.875	38.675		33.35	31.75		
22	0.148	0.894	1.588	1.567	0.750	1.687	0.750	1.687	1½ -18 NEF	1.438	1.375		
	3.76	22.71	40.325	39.80	19.05	42.85	19.05	42.85		36.53	34.925		
24	0.148	0.927	1.713	1.735	0.800	1.812	0.800	1.812	1? -18 NEF	1.563	1.500		
	3.76	23.55	43.51	44.07	20.32	46.05	20.32	46.05		39.70	38.10		

# Cable Mounting Receptacles

		Description	Amphenol Part No	Military No
 <p>Technical drawing of cable mounting receptacle 31T. It shows a side view with dimensions A (total length), B (threaded section length), F (threaded section length), and Y (height). A label 'X THREAD' points to the threaded section.</p>	<b>31T</b>	Basic cable mounting receptacle with threaded shell to accept standard cable accessories	<b>162 Series</b> 62GB-31T etc	
 <p>Technical drawing of cable mounting receptacle 11E. It shows a side view with dimensions A (total length), G (height), Y (height), B (threaded section length), and F (threaded section length).</p>	<b>11E</b>	Cable mounting receptacle with grommet and grommet nut	<b>162 Series</b> 162GB-11E etc	
 <p>Technical drawing of cable mounting receptacle 11F. It shows a side view with dimensions A (total length), G (height), H (height), Y (height), B (threaded section length), and F (threaded section length).</p>	<b>11F</b>	Cable mounting receptacle with grommet and grommet nut fitted with integral strain relief clamp	<b>162 Series</b> 162GB-11F etc	MS 3121F etc

# Dimensions and Mounting Details



## 162 OVERALL MATED DIMENSIONS –

Add the two relevant plug and receptacle overall Dimensions and deduct:

- 0.365 for shell sizes 20, 22, 24 (9.271)
- 0.303 for all other sizes (7.696)

Shell Size	'A' Overall Length Max.		
	31T in mm	(162) 11E in mm	(162) 11F in mm
08	1.286 32.665	1.320 33.53	1.759 44.68
10	1.286 32.665	1.320 33.53	1.759 44.68
12	1.286 32.665	1.320 33.53	1.759 44.68
14	1.286 32.665	1.320 33.53	1.733 44.02
16	1.286 32.665	1.320 33.53	1.873 47.575
18	1.286 32.665	1.320 33.53	1.873 47.575
20	1.348 34.24	1.382 35.10	2.115 53.72
22	1.348 34.24	1.382 35.10	2.115 53.72
24	1.348 34.24	1.382 35.10	2.247 57.07

Shell Size	Flange thickness ness ±0.005 (±0.127)	Flange dimensions max. sq.	Flange location ±0.005 (±0.127)	Overall rear diameter Max.		Cable Sleeve int. dia. ±0.005 (±0.127)	Thread	Shell ext. dia. Max.
	B			C	F			
	in mm	in mm	in mm	11F in mm	11E in mm	11F in mm	31T	in mm
08	0.094 2.39	0.817 20.75	0.415 10.54	0.828 21.03	0.561 14.25	0.156 3.96	<sup>7</sup> / <sub>16</sub> -28 UNEF	0.473 12.025
10	0.094 2.39	0.942 23.925	0.415 10.54	0.891 22.63	0.686 17.425	0.188 4.775	<sup>9</sup> / <sub>16</sub> -24 NEF	0.590 14.99
12	0.094 2.39	1.036 26.315	0.415 10.54	1.016 25.805	0.811 20.60	0.312 7.925	<sup>11</sup> / <sub>16</sub> -24 NEF	0.750 19.05
14	0.094 2.39	1.130 28.70	0.415 10.54	1.141 28.97	0.936 23.775	0.375 9.525	<sup>13</sup> / <sub>16</sub> -28 UNEF	0.875 22.225
16	0.094 2.39	1.223 31.065	0.415 10.54	1.203 30.555	1.061 26.95	0.500 12.7	<sup>15</sup> / <sub>16</sub> -20 UNEF	1.000 25.4
18	0.094 2.39	1.317 33.45	0.415 10.54	1.426 36.22	1.186 30.125	0.625 15.875	<sup>1</sup> / <sub>16</sub> -18 NEF	1.125 28.575
20	0.104/0.100 2.64/2.55	1.442 36.63	0.535 13.59	1.426 36.22	1.311 33.30	0.625 15.875	<sup>13</sup> / <sub>16</sub> -18 NEF	1.250 31.75
22	0.104/0.100 2.64/2.55	1.567 39.80	0.535 13.59	1.567 39.80	1.436 36.745	0.750 19.05	<sup>15</sup> / <sub>16</sub> -18 NEF	1.375 34.925
24	0.104/0.100 2.64/2.55	1.692 42.98	0.560/0.574 14.225/14.58	1.735 44.07	1.561 39.65	0.800 20.32	<sup>17</sup> / <sub>16</sub> -18 NEF	1.500 38.10

# Plugs

		Description	Amphenol Part No	Military No
	<b>36T</b>	Basic plug with threaded shells to accept standard cable accessories	<b>162 Series</b> 162GB-36T etc	
	<b>36TG</b>	Basic plug with grounding spring, threaded shell to accept standard cable accessories	<b>162 Series</b> 162GB-16E etc	
	<b>16E</b>	Plug with grommet and grommet nut	<b>162 Series</b> 162GB-16E etc	MS 3126E etc
	<b>16F</b>	Plug with grommet and grommet nut fitted with integral strain relief clamp	<b>162 Series</b> 162GB-16F etc	MS3126F etc

# Dimensions and Mounting Details



Shell Size	'A' Overall Length max.		
	36T and 36TG in mm	16F in mm	(162) 16E in mm
08	1.277	1.752	1.310
10	1.277	1.752	1.310
12	1.277	1.752	1.310
14	1.277	1.726	1.310
16	1.277	1.866	1.310
18	1.277	1.866	1.310
20	1.277	2.045	1.310
22	1.277	2.045	1.310
24	1.277	2.178	1.310
	32.44	55.32	33.27

**162 OVERALL MATED DIMENSIONS –**

Add the two relevant plug and receptacle overall Dimensions and deduct:

- 0.365 (9.271mm) for shell sizes 20, 22, 24
- 0.303 (7.696mm) for all other sizes

Shell Size	Overall dia. Max.	Coupling Ring dia. max.	Overall rear diameter Max.		Cable Sleeve int. dia. ±0.005 (±0.127)
	C	Y	G		H
	in mm	in mm	16E in mm	16F in mm	16F in mm
08	0.750	0.750	0.561	0.828	0.156
10	0.859	0.859	0.686	0.891	0.188
12	1.031	1.031	0.811	1.016	0.312
14	1.156	1.156	0.936	1.141	0.375
16	1.281	1.281	1.061	1.203	0.500
18	1.391	1.391	1.186	1.426	0.625
20	1.531	1.531	1.311	1.426	0.625
22	1.656	1.656	1.436	1.567	0.750
24	1.777	1.777	1.561	1.735	0.800
	45.135	45.135	39.65	44.07	20.32



# Plugs with optional Coupling Rings

		Description	Amphenol Part No
	<b>(044)</b>	Heavy duty coupling ring. Available for any of the plugs listed on page 22 To order complete assembly, add deviation (044) to connector number	<b>162 Series</b> 162GB-XXXXX-XX(044)
		<b>(218)</b>	Lever coupling ring. Mating and unmating only requires 120° movement. Available in shell size 14 and 16 only. Other sizes to special order.

## Dimensions and Mounting Details

### HEAVY DUTY COUPLING RINGS

Shell Size	Overall dia. max. W (044) in mm
08	0.870 22.1
10	0.979 24.865
12	1.151 29.235
14	1.276 32.41
16	1.401 35.585
18	1.505 38.225
20	1.651 41.935
22	1.776 45.11
24	1.897 48.18



### LEVER COUPLING RINGS

Shell Size	A Max in mm	C Max. in mm
14	1.444 36.67	0.787 19.98
16	1.444 36.67	0.844 21.43

### AUDIO CONNECTORS FOR TINSEL CORD

Shell Size	A Max in mm		B dia. Max in mm	H Cable Outlet Min in mm
	162GB-0506-10-6PX 162GB-0506-10-7PX	162GB-5001-10-7SX		
10	2.375 60.325	2.75 69.85	0.875 22.225	0.276 7.01

# Cable Accessories

SUITABLE FOR ALL EXTERNALLY THREADED  
PLUG OR RECEPTACLE SHELLS

		Description	Amphenol Part No
	<p><b>214</b></p>	<p>Grommet seal and nut. Provides an environmental seal for the exposed solder buckets in the openback class T shells.</p> <p>Grommet nut only for 162 Series.</p>	<p><b>162 Series</b> 162GB-214-XX† For Shell sizes 08-24 respectively</p>
	<p><b>129</b></p>	<p>Grommet and nut with strain relief clamp. The clamp prevents the flexing of the wires in the immediate vicinity of the risers, so avoiding the risk of leaks.</p> <p>Grommet nut with strain relief clamp only for 162 Series.</p>	<p><b>162 Series</b> 162GB-239-XX†</p>
	<p><b>201</b></p>	<p>Grommet and nut with right-angled strain relief clamp. The clamp prevents flexing of the wires in the immediate vicinity of the risers, so avoiding the risk of leaks (these are supplied to separate order only for use with style T shells).</p> <p>Grommet nut with strain relief clamp only for 162 Series.</p>	<p><b>162GB Series</b> 162GB-201-XX†</p>
	<p><b>5000</b></p>	<p>75° Clamp for screened jacketed cable with grommet. Effective sealing is provided over the range of cables covered by DEF 10 (Pattern C) as specified in DEF 5325-3. These are supplied to separate order only and are intended for use with style T shells.</p>	<p><b>162 Series</b> 162GB-5000-XX-†-XX**</p>

\* The suffix XX-XP or S enables the grommet to be matched to the insert arrangement (e.g. 12-3P).

\*\* The suffix XX specifies the cable size.

† The suffix XX specifies the shell size.

# Dimensions and Mounting Details

## SJ CLAMPS

### CABLES TO DEF STAN 10 and DEF STAN 61-12 part 5 e.g. def 10-3A or DEF STAN 16-2-3A

The 162 series clamps are identical to the 62 series clamps except that the grommet is omitted. It is however, still necessary to quote the full planform because the piece parts vary to suit the appropriate cable.

SJ clamps are available in 62 series **only where there is an appropriate cable to DEF 10 or DEF STAN 61-12 part 5 available for the planform.**

162 series availability is similar according to the planforms tooled. These are marked C on the table.

PLANFORM	CABLE DEF 10-etc DEF STAN 16-2 etc	PLANFORM	CABLE DEF 10 etc DEF STAN 16-2 etc	PLANFORM	CABLE DEF 10-etc DEF STAN 16- 2 etc
8-3	3A,3B,3C,2B	14-12 C	12A,12B,12C	20-16	-
8-3 3 C	3A,3B,3C,2B	14-15	-	20-41 C	36C
10-2	2A,2B,2C,2Q*	16-8	-	22-55	-
10-6 C	6A,6B,6C,4C	16-23 C	-	24-61 C	60C
12-3 C	3A,3B,3C,2Q*	16-26	25A,25B,25C		
12-10	10C	18-11	-	-	-

• Applicable to DEF10 only

**Type A Cables:** PVC outer sheath, no overall screen, L.T. (14/.0076) unscreened cores (equivalent DEF STAN 16-2 wire size)

**Type B Cables:** Outer screen, inner PVC sheath, L.T. (14.0076) unscreened cores (equivalent DEF STAN 16-2 wire size)

**Type C Cables:** Outer PVC sheath, inner screen, L.T. (14.0076) unscreened cores (equivalent DEF STAN 16-2 wire size)

**Type Q Cables:** Outer screen, inner PVC sheath, L.T. (36/.012) unscreened cores (DEF 10 only)

### Part Number Examples:

162GB-151-14-12 (no grommet supplied)

Shell Size	Overall Length (max.)			Straight SJ Clamps 162GB-151-XX max		75° SJ Clamps 162GB-5000-XX max	
	162GB-201-XX	162GB-129-XX in mm	162GB-160-168 in mm	Length including plug in mm	Length including receptacle in mm	Length including plug in mm	Length including receptacle in mm
08	1 <sup>5</sup> / <sub>32</sub>	<b>0.991</b> 25.17	<b>0.545</b> 13.84	<b>2.732</b> 69.39	<b>2.742</b> 69.64	<b>2.375</b> 60.235	<b>2.416</b> 61.365
10	1 <sup>3</sup> / <sub>16</sub>	<b>0.991</b> 25.17	<b>0.545</b> 13.84	<b>2.742</b> 69.64	<b>2.752</b> 69.90	<b>2.532</b> 64.39	<b>2.573</b> 65.35
12	1 <sup>7</sup> / <sub>32</sub>	<b>0.991</b> 25.17	<b>0.545</b> 13.84	<b>3.152</b> 80.06	<b>3.162</b> 80.31	<b>2.625</b> 66.675	<b>2.666</b> 67.715
14	1 <sup>1</sup> / <sub>4</sub>	<b>0.965</b> 24.51	<b>0.545</b> 13.84	<b>3.152</b> 80.06	<b>3.162</b> 80.31	<b>2.719</b> 69.035	<b>2.760</b> 70.095
16	1 <sup>5</sup> / <sub>16</sub>	<b>1.105</b> 28.065	<b>0.545</b> 13.84	<b>3.272</b> 83.10	<b>3.282</b> 83.36	<b>2.750</b> 69.80	<b>2.790</b> 70.87
18	1 <sup>3</sup> / <sub>8</sub>	<b>1.105</b> 28.065	<b>0.545</b> 13.84	-	-	-	-
20	1 <sup>3</sup> / <sub>8</sub>	<b>1.285</b> 32.64	<b>0.545</b> 13.84	<b>3.272</b> 83.10	<b>3.345</b> 84.96	<b>3.250</b> 82.55	<b>3.312</b> 84.125
22	1 <sup>29</sup> / <sub>64</sub>	<b>1.285</b> 32.64	<b>0.545</b> 13.84	-	-	-	-
24	1 <sup>15</sup> / <sub>32</sub>	<b>1.373</b> 34.875	<b>0.501</b> 12.725	<b>3.696</b> 93.87	<b>3.768</b> 95.70	<b>3.375</b> 85.725	<b>3.500</b> 88.90

Shell Size	B dia. max	G			J	K	L
	162GB-151-XX 162GB-5000-XX in mm	162GB-129-XX in mm	162GB-214 P or S in mm	All SJ Clamps in mm	Cable Sleeve Int. dia. ±0.005 ±0.127	162GB-201-XX in mm	36T 162GB-5000-XX in mm
08	<b>0.676</b> 17.17	<b>0.828</b> 21.03	<b>0.561</b> 14.25	<b>0.775</b> 19.68	<b>0.161</b> 4.09	<b>0.733</b> 18.62	<b>1.750</b> 44.45
10	<b>0.676</b> 17.17	<b>0.891</b> 22.63	<b>0.686</b> 17.425	<b>0.902</b> 22.91	<b>0.193</b> 4.90	<b>0.795</b> 20.19	<b>1.875</b> 47.625
12	<b>0.812</b> 20.62	<b>1.016</b> 25.805	<b>0.811</b> 20.60	<b>1.030</b> 26.16	<b>0.317</b> 8.05	<b>0.858</b> 21.79	<b>2.125</b> 53.975
14	<b>0.926</b> 23.52	<b>1.141</b> 28.98	<b>0.936</b> 23.775	<b>1.157</b> 29.385	<b>0.380</b> 9.65	<b>0.915</b> 23.24	<b>2.125</b> 53.975
16	<b>1.051</b> 26.695	<b>1.203</b> 30.555	<b>1.061</b> 26.95	<b>1.284</b> 32.61	<b>0.505</b> 12.83	<b>1.010</b> 25.65	<b>2.062</b> 52.375
18	-	<b>1.426</b> 36.22	<b>1.186</b> 30.125	-	<b>0.630</b> 16.00	<b>1.070</b> 27.18	-
20	<b>1.280</b> 32.51	<b>1.426</b> 36.22	<b>1.311</b> 33.30	<b>1.539</b> 39.09	<b>0.630</b> 16.00	<b>1.140</b> 28.955	<b>2.062</b> 52.375
22	-	<b>1.567</b> 39.80	<b>1.436</b> 36.745	-	<b>0.755</b> 19.175	<b>1.170</b> 29.72	-
24	<b>1.620</b> 41.15	<b>1.735</b> 44.07	<b>1.561</b> 39.65	<b>1.783</b> 45.29	<b>0.805</b> 20.45	<b>1.260</b> 32.00	<b>2.187</b> 55.55







# Dust Caps

TABLE OF STYLES

<p><b>62GB-736</b></p>		
<p><b>62GB-738</b></p>		
<p><b>62GB-742</b></p>		
<p><b>62GB-810</b></p>		
<p><b>62GB-812</b></p>		
<p><b>62GB-813</b></p>		

# Dust Caps

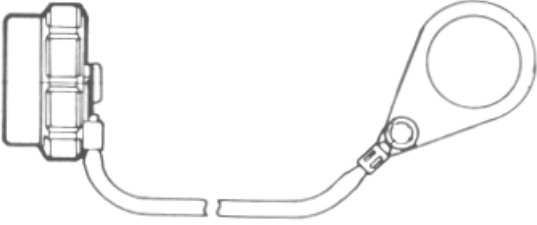
TABLE OF STYLES

<b>62GB-997</b>	 A photograph of a cylindrical dust cap with a chain and a large ring handle.	 A line drawing of the dust cap 62GB-997, showing its cylindrical body, chain, and large ring handle.
<b>62GB-998</b>	 A photograph of a cylindrical dust cap with a chain and a smaller ring handle.	 A line drawing of the dust cap 62GB-998, showing its cylindrical body, chain, and smaller ring handle.
<b>62GB-1069</b>	 A photograph of a cylindrical dust cap with a chain and a large ring handle.	 A line drawing of the dust cap 62GB-1069, showing its cylindrical body, chain, and large ring handle.
<b>62GB-1070</b>	 A photograph of a cylindrical dust cap with a chain and a smaller ring handle.	 A line drawing of the dust cap 62GB-1070, showing its cylindrical body, chain, and smaller ring handle.

# Dust Caps

## TABLE OF STYLES

**736**



**62GB-736**



Caps and Chains for Single Hole Mounting Receptacles

Shell Size	A ± 0.25 (± 6.35)	B ± 0.005 (± 0.13)	C dia. Max	J ± 0.005 (± 0.127)
08	3.0 76.2	0.521 13.23	0.734 18.64	0.578 14.68
10	3.0 76.2	0.521 13.23	0.859 21.82	0.703 17.86
12	3.5 88.9	0.521 13.23	1.000 25.4	0.891 22.63
14	3.5 88.9	0.521 13.23	1.125 28.57	1.016 25.81
16	3.5 88.9	0.521 13.23	1.250 31.75	1.141 29.39
18	3.5 88.9	0.521 13.23	1.375 34.92	1.266 32.16
20	4.0 101.6	0.521 13.23	1.500 38.1	1.391 35.33
22	4.0 101.6	0.521 13.23	1.625 41.27	1.516 38.51
24	4.0 101.6	0.556 14.12	1.750 44.45	1.641 41.68

**738**



**62GB-738**



Caps and Chains for Flange Mounting Receptacles

Shell Size	A ± 0.25 (± 6.35)	B ± 0.005 (± 0.13)	C dia. Max	J ± 0.005 (± 0.127)
08	3.0 76.2	0.521 13.23	0.734 18.64	0.125 3.18
10	3.0 76.2	0.521 13.23	0.859 21.82	0.125 3.18
12	3.5 88.9	0.521 13.23	1.000 25.4	0.125 3.18
14	3.5 88.9	0.521 13.23	1.125 28.57	0.125 3.18
16	3.5 88.9	0.521 13.23	1.250 31.75	0.125 3.18
18	3.5 88.9	0.521 13.23	1.375 34.92	0.125 3.18
20	4.0 101.6	0.521 13.23	1.500 38.1	0.125 3.18
22	4.0 101.6	0.521 13.23	1.625 41.27	0.125 3.18
24	4.0 101.6	0.556 14.12	1.750 44.45	0.152 3.66

**742**



**62GB-742**



Caps and Chains for Single Hole Mounting Receptacles

Shell Size	A ± 0.25 (± 6.35)	B ± 0.005 (± 0.13)	C dia. Max	J ± 0.005 (± 0.127)
<b>08</b>	<b>3.0</b> 76.2	<b>0.522</b> 13.25	<b>0.719</b> 18.26	<b>0.125</b> 3.18
<b>10</b>	<b>3.0</b> 76.2	<b>0.522</b> 13.25	<b>0.844</b> 21.43	<b>0.125</b> 3.18
<b>12</b>	<b>3.5</b> 88.9	<b>0.522</b> 13.25	<b>1.000</b> 25.4	<b>0.125</b> 3.18
<b>14</b>	<b>3.5</b> 88.9	<b>0.522</b> 13.25	<b>1.125</b> 28.57	<b>0.125</b> 3.18
<b>16</b>	<b>3.5</b> 88.9	<b>0.522</b> 13.25	<b>1.250</b> 31.75	<b>0.125</b> 3.18
<b>18</b>	<b>3.5</b> 88.9	<b>0.522</b> 13.25	<b>1.357</b> 34.92	<b>0.125</b> 3.18
<b>20</b>	<b>4.0</b> 101.6	<b>0.584</b> 14.83	<b>1.500</b> 38.1	<b>0.125</b> 3.18
<b>22</b>	<b>4.0</b> 101.6	<b>0.584</b> 14.83	<b>1.625</b> 41.27	<b>0.125</b> 3.18
<b>24</b>	<b>4.0</b> 101.6	<b>0.617</b> 15.67	<b>1.750</b> 44.45	<b>0.152</b> 3.86

### 810



### 62GB-810

BS9522-F0017-A2012

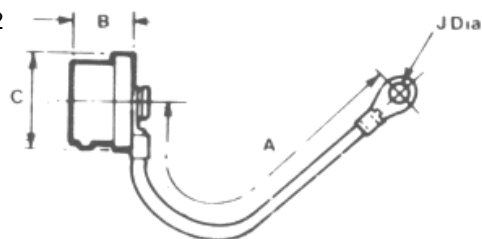

Caps and Cords for Plugs

Shell Size	A ± 0.25 (± 6.35)	B ± 0.005 (± 0.13)	C dia. Max	J ± 0.005 (± 0.127)
08	3.0 76.2	0.522 13.25	0.719 18.26	0.145 3.68
10	3.0 76.2	0.522 13.25	0.844 21.43	3.685 3.68
12	3.5 88.9	0.522 13.25	1.000 25.4	0.145 3.68
14	3.5 88.9	0.522 13.25	1.125 28.57	0.145 3.68
16	3.5 88.9	0.522 13.25	1.250 31.75	0.145 3.68
20	4.0 101.6	0.584 14.83	1.500 38.1	0.145 3.68
22	4.0 101.6	0.584 14.83	1.625 41.27	0.145 3.68
24	4.0 101.6	0.617 15.67	1.750 44.45	0.171 4.34

### 812



### 62GB-812

BS9522-F0017-A2013

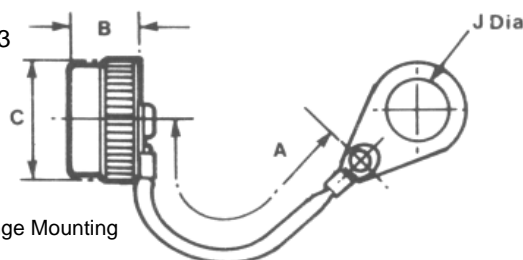

Caps and Cords for Flange Mounting Receptacles

Shell Size	A ± 0.25 (± 6.35)	B ± 0.005 (± 0.13)	C dia. Max	J ± 0.005 (± 0.127)
08	3.0 76.2	0.521 13.23	0.734 18.64	0.145 3.68
10	3.0 76.2	0.521 13.23	0.859 21.82	0.145 3.68
12	3.5 88.9	0.521 13.23	1.000 25.4	0.145 3.68
14	3.5 88.9	0.521 13.23	1.125 28.57	0.145 3.68
16	3.5 88.9	0.521 13.23	1.250 31.75	0.145 3.68
18	3.5 88.9	0.521 13.23	1.375 34.92	0.145 3.68
20	4.0 101.6	0.521 13.23	1.500 38.1	0.145 3.68
22	4.0 101.6	0.521 13.23	1.625 41.27	0.145 3.68
24	4.0 101.6	0.556 14.12	1.750 44.45	0.171 4.34



# Dust Caps

## TABLE OF STYLES

**813**



**62GB-813**

BS9522-F0017-A2014



Caps and Cords for Single Hole Mounting Receptacles

Shell Size	A ± 0.25 (± 6.35)	B ± 0.005 (± 0.13)	C dia. Max	J ± 0.005 (± 0.127)
<b>08</b>	<b>3.0</b> 76.2	<b>0.521</b> 13.23	<b>0.734</b> 18.64	<b>0.578</b> 14.68
<b>10</b>	<b>3.0</b> 76.2	<b>0.521</b> 13.23	<b>0.859</b> 21.82	<b>0.703</b> 17.86
<b>12</b>	<b>3.5</b> 88.9	<b>0.521</b> 13.23	<b>1.000</b> 25.4	<b>0.891</b> 22.63
<b>14</b>	<b>3.5</b> 88.9	<b>0.521</b> 13.23	<b>1.125</b> 28.57	<b>1.016</b> 25.81
<b>16</b>	<b>3.5</b> 88.9	<b>0.521</b> 13.23	<b>1.250</b> 31.75	<b>1.141</b> 29.39
<b>18</b>	<b>3.5</b> 88.9	<b>0.521</b> 13.23	<b>1.375</b> 34.92	<b>1.266</b> 32.16
<b>20</b>	<b>4.0</b> 101.6	<b>0.521</b> 13.23	<b>1.500</b> 38.1	<b>1.391</b> 35.33
<b>22</b>	<b>4.0</b> 101.6	<b>0.521</b> 13.23	<b>1.625</b> 41.27	<b>1.516</b> 38.56
<b>24</b>	<b>4.0</b> 101.6	<b>0.556</b> 14.12	<b>1.750</b> 44.45	<b>1.641</b> 41.68

# Dust Caps

## TABLE OF STYLES

**997**



**62GB-997**



Caps and Chains Ribbed for Single Hole Mounting Receptacles

Shell Size	A ± 0.25 (± 6.35)	B ± 0.005 (± 0.13)	C dia. Max	J ± 0.005 (± 0.127)
08	3.0 76.2	0.521 13.23	0.892 22.66	0.578 14.69
10	3.0 76.2	0.521 13.23	1.017 26.84	0.703 17.86
12	3.5 88.9	0.521 13.23	1.142 29.01	0.891 22.64
14	3.5 88.9	0.521 13.23	1.267 32.19	1.016 25.81
16	3.5 88.9	0.521 13.23	1.454 36.94	1.141 28.99
18	3.5 88.9	0.521 13.23	1.563 39.70	1.266 32.16
20	4.0 101.6	0.521 13.23	1.687 42.85	1.391 35.34
22	4.0 101.6	0.521 13.23	1.797 45.65	1.516 38.51
24	4.0 101.6	0.556 14.12	1.922 48.82	1.641 41.69

**998**



**62GB-998**



Caps and Chains Ribbed for Plugs

Shell Size	A ± 0.25 (± 6.35)	g max	C dia. Max	J ± 0.005 (± 0.127)
08	3.0 76.2	0.562 14.28	0.892 22.66	0.124 3.18
10	3.0 76.2	0.562 14.28	1.017 25.84	0.124 3.18
12	3.5 88.9	0.562 14.28	1.142 29.01	0.124 3.18
14	3.5 88.9	0.562 14.28	1.267 32.19	0.124 3.18
16	3.5 88.9	0.562 14.28	1.454 36.94	0.124 3.18
18	3.5 88.9	0.562 14.28	1.563 39.70	0.124 3.18
20	4.0 101.6	0.624 15.85	1.687 42.85	0.124 3.18
22	4.0 101.6	0.624 15.85	1.797 45.65	0.124 3.18
24	4.0 101.6	0.624 15.85	1.922 48.82	0.147 3.74

# Dust Caps

## TABLE OF STYLES

**1069**



**62GB-1069**



Caps and Cords Ribbed for Single Hole Mounting Receptacles

Shell Size	A ± 0.25 (± 6.35)	B ± 0.005 (± 0.13)	C dia. Max	J ± 0.010 (± 0.25)
08	3.0 76.2	0.521 13.23	0.892 22.66	0.578 14.69
10	3.0 76.2	0.521 13.23	1.017 26.84	0.703 17.86
12	3.5 88.9	0.521 13.23	1.142 29.01	0.891 22.64
14	3.5 88.9	0.521 13.23	1.267 32.19	1.016 25.81
16	3.5 88.9	0.521 13.23	1.454 36.94	1.141 28.99
18	3.5 88.9	0.521 13.23	1.563 39.70	1.266 32.16
20	4.0 101.6	0.521 13.23	1.687 42.85	1.391 35.34
22	4.0 101.6	0.521 13.23	1.797 45.65	1.516 38.51
24	4.0 101.6	0.556 14.12	1.922 48.82	1.641 41.696

**1070**



**62GB-1070**

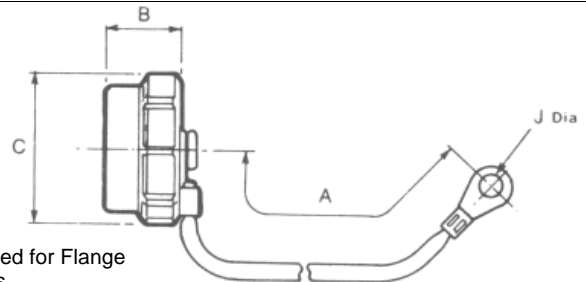

Caps and Cords Ribbed for Flange Mounting Receptacles

Shell Size	A ± 0.25 (± 6.35)	B ± 0.005 (± 0.13)	C dia. Max	J ± 0.005 (± 0.127)
08	3.0 76.2	0.521 13.23	0.892 22.66	0.117 3.03
10	3.0 76.2	0.521 13.23	1.017 26.66	0.119 3.03
12	3.5 88.9	0.521 13.23	1.142 29.01	0.119 3.03
14	3.5 88.9	0.521 13.23	1.267 32.19	0.119 3.03
16	3.5 88.9	0.521 13.23	1.454 36.94	0.119 3.03
18	3.5 88.9	0.521 13.23	1.563 39.70	0.119 3.03
20	4.0 101.6	0.521 13.23	1.687 42.85	0.110 3.03
22	4.0 101.6	0.521 13.23	1.797 45.65	0.119 3.03
24	4.0 101.6	0.556 14.12	1.922 48.82	0.147 3.74

# Interconnection Accessories

## 5001 BACKSHELL SERIES

- For use on 162GB connector styles
- The 5001 Backshells are suitable for termination using Bandit, Zetalock and Heatshrink product
- The 5001 Backshell is designed to give 360° screening



### Part Numbering Information

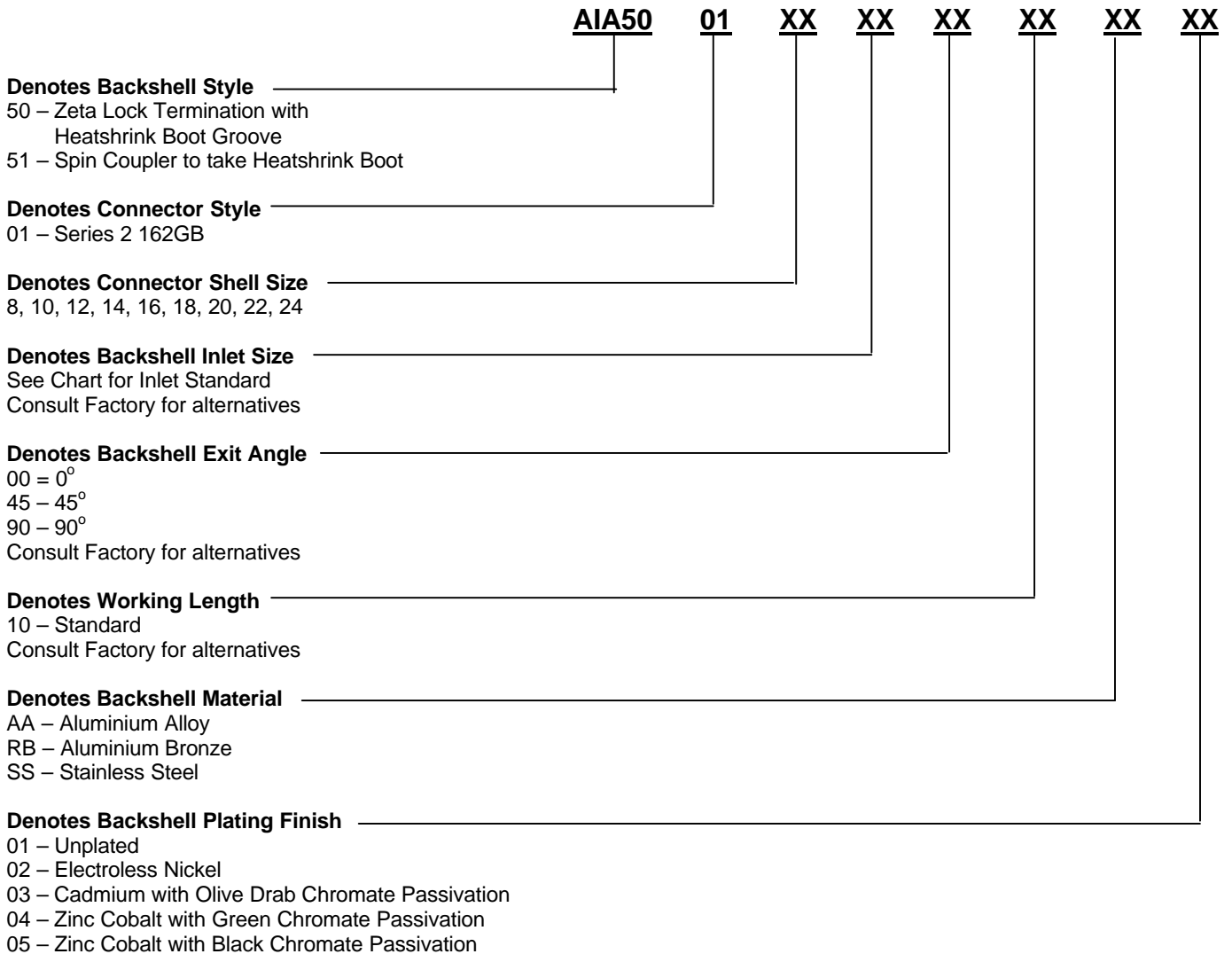

# Interconnection Accessories

## 5001 BACKSHELL SERIES - STRAIGHT



Part Number	A-Thread	ØB MAX	ØG MAX	ØH MAX	Rec Hellerman Boot 90°	Rec Hellerman Boot Straight	Spring Ref
5001-08-00-00-10-AA-XX	7/16-28 UNEF	18.14	6.48	14.04	1152-4-GW24	152-42-GW24	HE 050
5001-10-00-00-10-AA-XX	9/16-24 UNEF	20.45	8.05	15.61	1154-4-GW24	154-42-GW24	HE 100
5001-12-00-00-10-AA-XX	11/16-24 UNEF	24.64	11.25	18.81	1155-4-GW24	155-42-GW24	HE 100
5001-14-00-00-10-AA-XX	13/16-20 UNEF	29.13	12.83	20.39	1155-4-GW24	155-42-GW24	HE 200
5001-16-00-00-10-AA-XX	15/16-20 UNEF	32.13	16.00	23.57	1156-4-GW24	155-42-GW24	HE 200
5001-18-00-00-10-AA-XX	1 1/16-18 UNEF	32.64	19.18	26.74	1156-4-GW24	156-42-GW24	HE 300
5001-20-00-00-10-AA-XX	1 3/16-18 UNEF	39.78	22.38	29.92	1157-4-GW24	157-43-GW24	HE 300
5001-22-00-00-10-AA-XX	1 5/16-18 UNEF	43.28	25.55	33.09	1157-4-GW24	157-43-GW24	HE 300
5001-24-00-00-10-AA-XX	1 7/16-18 UNEF	44.25	25.55	33.09	1157-4-GW24	157-43-GW24	HE 300
5001-08-06-00-10-AA-XX	7/16-28 UNEF	18.14	4.83	14.04	1152-4-GW24	152-42-GW24	HE 050
5001-10-08-00-10-AA-XX	9/16-24 UNEF	20.45	6.48	14.04	1154-4-GW24	154-42-GW24	HE 050
5001-12-10-00-10-AA-XX	11/16-24 UNEF	24.64	8.05	15.61	1155-4-GW24	155-42-GW24	HE 100
5001-14-12-00-10-AA-XX	13/16-20 UNEF	29.13	11.25	18.81	1155-4-GW24	155-42-GW24	HE 100
5001-16-14-00-10-AA-XX	15/16-20 UNEF	32.13	12.83	20.39	1156-4-GW24	156-42-GW24	HE 200
5001-18-16-00-10-AA-XX	1 1/16-18 UNEF	32.64	16.00	23.57	1156-4-GW24	156-42-GW24	HE 200
5001-20-18-00-10-AA-XX	1 3/16-18 UNEF	39.78	19.18	26.74	1157-4-GW24	157-43-GW24	HE 300
5001-22-20-00-10-AA-XX	1 5/16-18 UNEF	43.28	22.38	29.92	1157-4-GW24	157-43-GW24	HE 300
5001-24-22-00-10-AA-XX	1 7/16-18 UNEF	44.25	25.55	33.09	1157-4-GW24	157-43-GW24	HE 300

All dimensions in mm

# Interconnection Accessories

## 5001 BACKSHELL SERIES – RIGHT ANGLE



Part Number	A-Thread	D MAX	ØB MAX	E MAX	ØG MAX	ØH MAX	J MAX	Rec Hellerman Boot Straight	Spring Ref
5001-08-00-90-AA-XX	7/16-28 UNEF	35.18	18.14	25.98	6.48	14.04	32.39	152-42-GW24	HE 050
5001-10-00-90-AA-XX	9/16-24 UNEF	38.35	20.45	29.16	8.05	15.61	35.56	154-42-GW24	HE 100
5001-12-00-90-AA-XX	11/16-24 UNEF	39.75	24.64	32.33	11.25	18.81	38.74	155-42-GW24	HE 100
5001-14-00-90-AA-XX	13/16-20 UNEF	46.30	29.13	37.11	12.83	20.39	43.51	155-42-GW24	HE 200
5001-16-00-90-AA-XX	15/16-20 UNEF	47.70	32.13	40.28	16.00	23.57	46.69	156-42-GW24	HE 200
5001-18-00-90-AA-XX	1 1/16-18 UNEF	47.70	32.64	40.28	19.18	26.74	46.69	156-42-GW24	HE 300
5001-20-00-90-AA-XX	1 3/16-18 UNEF	55.63	39.78	48.21	22.38	29.92	54.61	157-43-GW24	HE 300
5001-22-00-90-AA-XX	1 5/16-18 UNEF	58.80	43.28	51.38	25.55	33.09	57.79	157-43-GW24	HE 300
5001-24-00-90-AA-XX	1 7/16-18 UNEF	58.80	44.25	51.38	25.55	33.09	57.79	157-43-GW24	HE 300
5001-08-06-90-AA-XX	7/16-28 UNEF	33.40	18.14	25.98	4.83	14.04	32.39	152-42-GW24	HE 050
5001-10-08-90-AA-XX	9/16-24 UNEF	36.58	20.45	29.16	6.48	14.04	35.56	154-42-GW24	HE 050
5001-12-10-90-AA-XX	11/16-24 UNEF	39.75	24.64	32.33	8.05	15.61	38.74	155-42-GW24	HE 100
5001-14-12-90-AA-XX	13/16-20 UNEF	44.53	29.13	37.11	11.25	18.81	43.51	155-42-GW24	HE 100
5001-16-14-90-AA-XX	15/16-20 UNEF	47.70	32.13	40.28	12.83	20.39	46.69	156-42-GW24	HE 200
5001-18-16-90-AA-XX	1 1/16-18 UNEF	47.70	32.64	40.28	16.00	23.57	46.69	156-42-GW24	HE 200
5001-20-18-90-AA-XX	1 3/16-18 UNEF	55.63	39.78	48.21	19.18	26.74	54.61	157-43-GW24	HE 300
5001-22-20-90-AA-XX	1 5/16-18 UNEF	58.80	43.28	51.38	22.38	29.92	57.79	157-43-GW24	HE 300
5001-24-22-90-AA-XX	1 7/16-18 UNEF	58.80	44.25	51.38	25.55	33.09	57.79	157-43-GW24	HE 300

# Interconnection Accessories

## INSTALLATION - PROCEDURE

- Prepare the cable making sure that a sufficient length of shield is available, so that it fits against the front shoulder of the lip groove.
- Before insertion of connector contacts, slide the heat-shrinkable connector boot onto the cable followed by the Spring Adapter.



- Position the heatshrinkable boot, Spring Adapter, and shield braid out of the way and insert the connector contacts. Depending upon the shielding braid size, it can either be folded back onto itself or bunched up concertina style out of the way for easy access to the cable conductors.
- Screw the Spring Adapter onto the connector and tighten to the torque value specified by the connector manufacturer. Typical torque values are shown in table on Page 7. It is recommended that the connector threads are lubricated with a suitable compound if a liquid thread lock is not used. The adapter should be hand tightened to ensure proper thread alignment and then tightened with a strap wrench and torque meter to the specified torque.
- Bring the cable shield braid up onto the adapter body so that it fits against the front shoulder of the lip groove. Alternatively extend the braid past the lip groove.

**NOTE:** After assembly, braid can be trimmed with side cutters or folded back and secured with high temperature tape



- Open up the constant force spring and wrap it around the cable braid section that is positioned over the constant force spring slot area of the adapter. This is most easily accomplished by lifting up the end of the spring and trapping the braid covered adapter between the spring coil and raised end. The spring will now stay in place and can be installed by simply rolling the coil around the braid covered adapter. Refer to appropriate code of practice for procedure to install heatshrink shape.



### Re-Entry Procedure

- Reheat the heatshrink shape, remove to expose the Zetalok™ spring and braid.
- Once spring is exposed, lift up the edge of the Zetalok™ spring and push it around the circumference of the assembly to form a coil which can then be rolled around the assembly to remove the spring.
- Lift the cable screen braid off the backshell and push it back out of the way.
- Unscrew the backshell and push it back out to facilitate repairs at the connector or exposed connector area.
- Follow the practice detailed in these instructions to re-install the Zetalok™ spring backshell

*Note: The Zetalok™ spring can be installed and removed an infinite number of times if not bent or distorted in any way during the removal process.*



# Interconnection Accessories

## SHIELD TERMINATION ASSEMBLY PROCESS

1. Prepare Cable Braid for termination process (Figure 1)
2. Push Braid forward over Adapter Retention Lip to the Adapter Incline Point (or .4" [10.2mm] minimum braid length). Milk Braid as required to remove slack and ensure a snug fit around the shield termination area (Figure 2).
3. Prepare the Band in the following manner:

**IMPORTANT: Due to Connector/ Adapter circumference, it may be necessary to prepare the Band around the Cable or Retention Area.**

- a) Roll Band through the Buckle Slot twice (Bands must be double-coiled).
- b) Pull on Band until Mark (▷) is within approximately (.250 inch (6.4mm) of Buckle Slot (Figure 3). The Band may be tightened further if desired.

**NOTE: Prepared Band should have (▷) Mark visible approximately where shown in Figure 3.**

### **SHIELD TERMINATION CLAMPING PROCESS (Figures 4 through 8):**

**NOTE: To free Tool Handles, move Holding Clips to centre of Tool.**

4. Squeeze Gripper Release Lever and insert Band into the front end opening of the Tool. (NOTE: Circular portion of looped band must always be face downward).
  5. Aligning the Band and Tool with the Shield Termination Area, squeeze Black Pull-Up Handle repeatedly using short strokes until it locks against the Tool Body. (This indicates the Band is compressed to the Tool Pre-calibrated Tension).
- NOTE: If alignment of band and shield is unsatisfactory, tension on band can be relaxed by pushing on slotted release lever on top of tool. Make adjustments as necessary and again squeeze black pull-up handle.**
6. Complete the Clamping Process by squeezing the Grey Cut-Off Handle.
  7. Remove excess Band from Tool.
  8. Inspect Shield Termination.



# Key/Keyway Orientations

FOR Patt. 105 DEF STAN 59-35 (Part 1) Sec. 3



3 Pins spaced  
120° apart

Datum is always taken from major key or keyway. In receptacles the major keyway always remains fixed in relation to the mounting flange. For the A\*, B, C, D\*, E and F orientations, the three bayonet locations and associated minor keyways are rotated complete, in accordance with the table below.

N.B. The accompanying diagram shows a receptacle shell, with keyways. Corresponding key orientations for a mating plug shell are therefore always clockwise.

Shell Size	Values for a(degrees)							Values for ? (degrees)							Values for β (degrees)						
	N	A*	B	C	D*	E	F	N	A*	B	C	D*	E	F	N	A*	B	C	D*	E	F
8	105	92	-	-	118	118	82	35	35	-	-	35	30	50	75	75*	-	-	75	100	75
10	105	95	85	125	115	115	85	35	35	35	35	35	30	50	75	75	75	75	75	100	75
12	105	97	89	121	113	115	85	35	35	35	35	35	30	50	75	75	75	75	75	100	75
14	105	98	91	119	112	75	120	35	35	35	35	35	30	50	75	75	75	75	75	100	75
16	105	99	93	117	111	75	120	35	35	35	35	35	30	50	75	75	75	75	75	100	75
18	105	100	95	115	110	75	120	35	35	35	35	35	30	50	75	75	75	75	75	100	75
20	105	100	95	115	110	75	120	35	35	35	35	35	30	50	75	75	75	75	75	100	75
22	105	101	97	113	109	75	120	35	35	35	35	35	30	50	75	75	75	75	75	100	75
24	105	101	97	113	109	75	120	35	35	35	35	35	30	50	75	75	75	75	75	100	75

Shell Size	Values for f (degrees) Orientation							Values for ? (degrees) Orientation						
	N	A*	B	C	D*	E	F	N	A*	B	C	D*	E	F
8	50	50	-	-	50	30	45	60	47	-	-	73	73	47
10	50	50	50	50	50	30	45	60	50	40	80	70	70	50
12	50	50	50	50	50	30	45	60	52	44	76	68	70	50
14	50	50	50	50	50	30	35	60	53	46	74	67	30	75
16	50	50	50	50	50	30	35	60	54	48	72	66	30	75
18	50	50	50	50	50	30	35	60	55	50	70	65	30	75
20	50	50	50	50	50	30	35	60	55	50	70	65	30	75
22	50	50	50	50	50	30	35	60	56	52	68	64	30	75
24	50	50	50	50	50	30	35	60	56	52	68	64	30	75

\* now inactive for new designs against Pattern 105 but available for replacement purposes. Superseded in DEF STAN 59-35 (Part 1) Sec. 3. by orientations E and F.

# Insert Orientations

FOR MIL-C-26482 AND REPLACEMENT PURPOSES  
IN Patt. 105 OF DEF STAN 59-35 (Part 1) Sec. 3

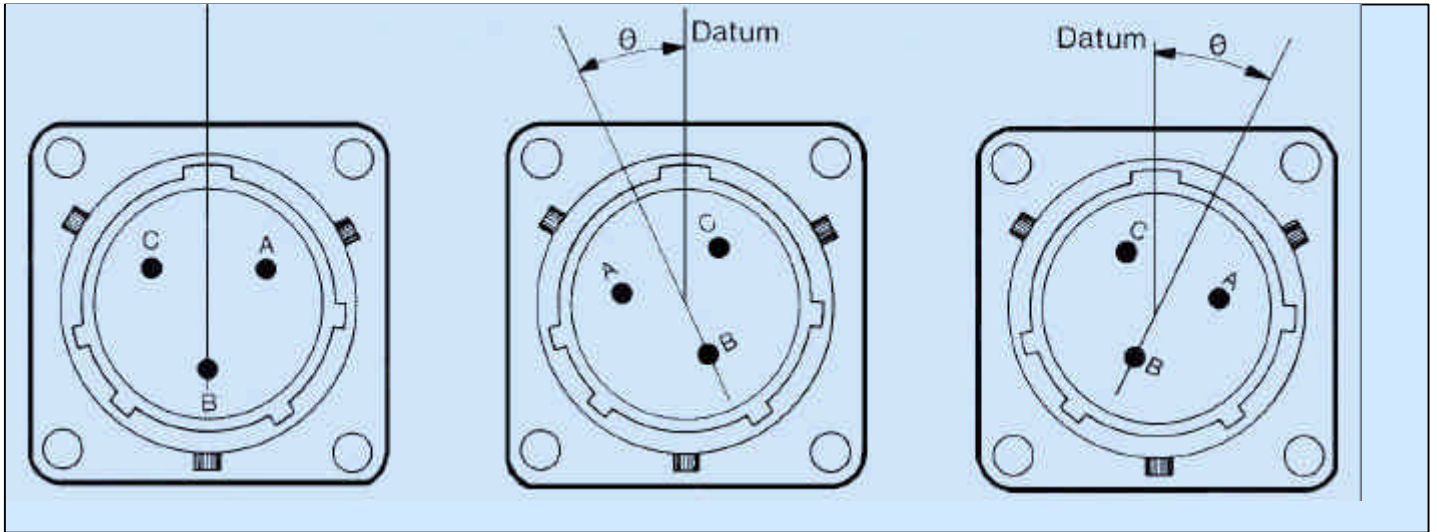

Normal Position  
with Pin Contacts

Alternative Position of Insert  
with Socket Contacts  
( $\theta$  counterclockwise)

Alternate Position of Insert  
with Pin Contacts  
( $\theta$  clockwise)

Each diagram shows mating face of insert

Insert Arrangement	Normal	Orientation $\theta$ (degrees)			Z
		W	X	Y	
8-3	0	60	210	-	-
8-33	0	90	-	-	-
8-98	0	-	-	-	-
10-2	0	-	-	-	-
10-6	0	90	-	-	-
10-7	0	-	-	-	-
12-3	0	-	-	180	-
12-10	0	60	155	270	295
14-5	0	40	92	184	273
14-12	0	43	90	-	-
14-19	0	30	165	315	-
16-8	0	54	152	180	331
16-23	0	158	270	-	-
16-26	0	60	-	275	338
18-11	0	62	119	241	340
18-32	0	85	138	222	265
20-41	0	45	126	225	-
22-21	0	16	135	175	349
22-55	0	30	142	226	314
24-61	0	90	180	270	324

# Assembly Instructions

## FOR AMPHENOL STRAIGHT S.J. CLAMPS TO DEF STAN 59-35 (Part 1) Sec. 3 FOR INTERNALLY AND EXTERNALLY SCREENED AND UNSCREENED CABLES

### INTERNALLY SCREENED JACKETED CABLE TYPE C

#### Cable and Wire Stripping

Strip the outer P.V.C. Jacket of the cable back to dim 'A' to expose the internal braid. Trim the braid back to within 19.05mm (0.75 in) of P.V.C. jacket and fold back 'B'

Size	A Dimension	
	mm	in
08	34.93	1.375
10	36.51	1.437
12 & 14	41.27	1.625
16 & 20	44.45	1.750
24	49.21	1.937

#### FOR 162 SERIES

Strip 5.6mm (0.220 in) to 6.6mm (0.260 in) of insulation from each wire taking care not to cut or nick strands. If ends fray twist them back to their original lay.



#### INITIAL ASSEMBLY

Slide onto the cable the following items in this order (1) Nut (2) Washer (3) Gasket (4) Braid Clamp and (5) Clamp Body



#### CRIMP CONNECTION TO CONTACTS (162 SERIES)

Using the recommended tools, crimp the contacts to the wires and insert them in the connector as described in the Amform instructions, which are supplied with each 162 series assembly.

Bring up clamp body taking care not to drag the braid forward. (If necessary a small amount of thin tape may be used to hold the braid in position whilst carrying out this operation). Screw the clamp body onto the connector accessory thread, making sure that the connector serrations engage with those on clamp body. Fold the braid out at right angles to the cable and slide forward the braid clamp. Smooth back braid onto the braid clamp and trim off the surplus. Slide up gasket, washer, screw on nut and tighten.



# Assembly Instructions

FOR AMPHENOL STRAIGHT S.J. CLAMPS TO  
DEF STAN 59-35 (Part 1) Sec. 3 FOR

INTERNALLY AND EXTERNALLY SCREENED AND UNSCREENED CABLES

## EXTERNALLY SCREENED JACKETED CABLE TYPES 'B & Q'

### Cable and Wire Stripping

Strip the outer braid and internal P.V.C. jacket of the cable back to dim 'A'

Size	A Dimension	
	mm	in
08	33.32	1.312
10	34.93	1.375
12 & 14	39.70	1.563
16 & 20	42.85	1.687
24	47.63	1.875

### FOR 162 SERIES

Strip 5.6mm (0.220 in) to 6.6mm (0.260 in) of insulation from each wire taking care not to cut or nick strands. If ends fray twist them back to their original lay.

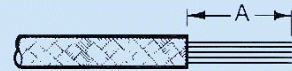

### INITIAL ASSEMBLY

Slide onto the cable the following items in this order (1) Nut (2) Washer (3) Male Braid Clamp Convolute Screen (See B) as far as possible, and slide on times (4) Female Braid Clamp (5) Gasket and (6) Clamp Body



### CRIMP CONNECTION TO CONTACTS (162 SERIES)

Using the recommended tools, crimp the contacts to the wires and insert them in the connector as described in the Amform instructions, which are supplied with each 162 series assembly. Bring up clamp body and screw onto the connector accessory thread, making sure that the connector serrations engage with those on clamp body. Slide forward gasket and female braid clamp. Push forward screen and fold out at right angles braid which does not return to original position. Slide up male braid clamp. Smooth back braid onto male braid clamp and trim off surplus. Slide up washer. Screw on nut and tighten.



Surplus Braid  
Trimmed

### UNSCREENED JACKETED CABLES TYPE 'A'

All procedures concerning this type of cable to be as for internally screened jacketed cable but all references to screen (Braid) to be disregarded.

# Assembly Instructions

FOR AMPHENOL ANGLED S.J. CLAMPS TO  
DEF STAN 59-35 (Part 1) Sec. 3 FOR

INTERNALLY AND EXTERNALLY SCREENED AND UNSCREENED CABLES

## INTERNALLY SCREENED JACKETED CABLE TYPE 'C'

### Cable and Wire Stripping

Strip the outer P.V.C. jacket of the cable back to dim 'A' to expose the internal braid. Trim the braid back to within 19.05mm (0.75 in) of P.V.C. jacket and fold back 'B'.

Size	A Dimension	
	mm	in
08	58.15	2.890
10/12 & 14	66.68	2.625
16	69.85	2.750
20	88.90	3.500
24	95.25	3.750

### FOR 162 SERIES

Strip 5.6mm (0.220 in) to 6.6mm (0.260 in) of insulation from each wire taking care not to cut or nick strands. If ends fray twist them back to their original lay.



### INITIAL ASSEMBLY

Slide onto the cable the following items in this order (1) Nut (2) Washer (3) Gasket (4) Braid Clamp (5) 75° Angled Body



### CRIMP CONNECTION TO CONTACTS (162 SERIES)

Using the recommended tools, crimp the contacts to the wires and insert them in the connector as described in the Amform instructions, which are supplied with each 162 series assembly. Bring up clamp body taking care not to drag the braid forward. (If necessary a small amount of thin tape may be used to hold the braid in position whilst carrying out this operation). Screw the clamp body onto the connector accessory thread, making sure that the connector serrations engage with those on the clamp body. Fold the braid out at right angles to the cable and slide forward the braid clamp. Smooth back braid onto the braid clamp and trim off the surplus. Slide up gasket, washer, screw on nut and tighten.



# Assembly Instructions

FOFOR AMPHENOL ANGLED S.J. CLAMPS TO  
DEF STAN 59-35 (Part 1) Sec. 3 FOR  
INTERNALLY AND EXTERNALLY SCREENED AND UNSCREENED CABLES

## EXTERNALLY SCREENED JACKETED CABLES TYPES 'B' & 'Q'

### Cable and Wire Stripping

Strip the outer braid and internal P.V.C. jacket of the cable back to dim 'A'.

Size	A Dimension	
	mm	in
08	58.15	2.890
10, 12 & 14	66.68	2.625
16	69.85	2.750
20	88.90	3.500
24	95.25	3.750

### FOR 162 SERIES

Strip 5.6mm (0.220 in) to 6.6mm (0.260 in) of insulation from each wire taking care not to cut or nick strands. If ends fray twist them back to their original lay.



### INITIAL ASSEMBLY

Slide onto the cable the following items in this order:

(1) Nut (2) Washer (3) Male Braid Clamp – Convolute Screen (See B) as far as possible and slide on items (4) Female Braid Clamp (5) Gasket (6) 75° Right Angled Body



### CRIMP CONNECTION TO CONTACTS (162 SERIES)

Using the recommended tools, crimp the contacts to the wires and insert them in the connector as described in the Amform instructions, which are supplied with each 162 series assembly. Bring up clamp body taking care not to drag the braid forward. (If necessary a small amount of thin tape may be used to hold the braid in position whilst carrying out this operation). thread, making sure that the connector serrations engage with those on the clamp body. Fold the braid out at right angles to the cable and slide forward the braid clamp. Smooth back braid onto the braid clamp and trim off the surplus. Slide up gasket, washer, screw on nut and tighten.



### UNSCREENED JACKETED CABLES 'TYPE A'

All procedures concerning this type of cable to be as for internally screened jacketed cable but all references to screen (Braid) to be disregarded.

# 162GB Assembly Instructions

## WIRE STRIPPING – 162GB SERIES

Strip 5.6mm (.220 in) to 6.6mm (.260 in) of insulation from end of wire for both size 20 and 16 contacts taking care not to cut or nick strands. If ends fray twist them back to their original lay.

## CONTACT AND WIRE DATA – 162GB SERIES

Contact Size	Colour Code	Contact Part Nos	Suitable Wire Sizes		Permissible Insulation O.D. range for Grommet Sealing	Stripping Lengths in mm
			A.W.G.	in mm		
20	RED	Pin: 162GB-149-20000-05 Skt: 162GB-101-20000-05	20, 22, 24	0.032 – 0.020 0.81-0.51	0.047 – 0.085 1.19 - 2.16	0.220-0.260 5.6 - 6.6
16	BLUE	Pin: 162GB-149-16000-05 Skt: 162GB-101-16000-05	16, 18, 20	0.051 – 0.032 1.295 – 0.81	0.066 – 0.109 1.675 – 2.77	0.220 – 0.260 5.6 – 6.6

## CRIMP WIRE CONTACTS

Use Amphenol 294-542 Crimp Tool (M22520/1-01) with 294-1889-01 Turret Head (M22520/1-02). Release and rotate Turret Knob to proper contact size (as per colour code) and lock adjust Selector Knob on handle to correct wire size [see table]. Insert stripped wire into Contact Pocket until it is visible through inspection hole. Fully seat Contact in Crimp Tool Positioner and close handles in one full stroke. (The Ratchet will not release until tool has completed full stroke). Inspect Crimp for wire visibility through Inspection Hole.

## CRIMPING JAW SETTING

Contact Size	Wire Size	Crimp Jaw Setting
20	24	No. 2
	22	No.3
	20	No.4
16	20	No. 4
	18	No. 5
	16	No. 6

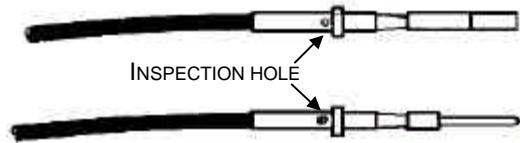

## CRIMPING WIRE TO CONTACT

## CONTACT INSERTION

Select the proper insertion tool for the size of contact Table 1. The Insertion Tool and procedure are the same for both pin and socket contacts. Slide rear accessory and sleeve over wire bundle. Lay wire in groove of insertion tool and slide contact into front of tool until it is properly located in tool probe. Insert contact into the correct hole in the rear face of the grommet. Keeping contact in line with the axis of the hole, apply a smooth even push on the tool until the contact is fully seated in position. Note: it is essential that the contact and tool are correctly aligned with the axis of hole during insertion to prevent damage to contacts. Withdraw tool at right angles to grommet surface until complete free of connector. All contacts must be inserted whether in circuit or not and the appropriate size sealing plug used behind any contacts that are not wired. Push the sealing plug in by hand until it is fully seated.

TABLE 1				
Contact Size	Colour Code	Insertion Tool Part No.		Grommet Sealing Plug
		Amphenol	M.S.	
20	RED	294GB-5000-20	-	162GB-130-20000
16	BLUE	294-96	MS 24256A-16	162GB-130-16000





### Contact Size

CAUTION: extra care is required in this operation to prevent damage to the connector.

Remove the rear accessory and sleeve and slide back on wire bundle. Select the proper removal tool for the size of contact from table 2. The same tool is used for both pin and socket contacts. Position the removal tool over the contacts to be removed and push until tool probe is fully bottomed, shown when indicator band enters insert hole. Tool is inserted to first band only when removing pin contacts and to the second band for socket contact removal. Slide the plunger knob forward to remove contact.

TABLE 2			
Contact Size	Colour Code	Removal Tool Part Number	
		Amphenol	M.S.
20	RED	294-89	MS 24256R-20
16	BLUE	294-97	MS 25246R-16

Details of operator training are available from Amphenol upon request.



**Notice:** Products are sold subject to Amphenol's conditions of sale ("the standard conditions"). All specifications and statements contained herein are believed to be correct at the time of printing but no representation or warranty, express or implied, is given as to any specification or statement contained herein. Product specifications including performance characteristics are typical only and subject to deviation. Specifications are also subject to change without notice. Users should not assume that all safety measures are indicated or that other measures may not be required. No representation or warranty, express or implied, is given that any use of products (including any stated or suggested use) does not infringe any patent, registered design or other third party rights and no stated or suggested use of products can be taken to recommend any such infringement.



Компания «ЭлектроПласт» предлагает заключение долгосрочных отношений при поставках импортных электронных компонентов на взаимовыгодных условиях!

Наши преимущества:

- Оперативные поставки широкого спектра электронных компонентов отечественного и импортного производства напрямую от производителей и с крупнейших мировых складов;
- Поставка более 17-ти миллионов наименований электронных компонентов;
- Поставка сложных, дефицитных, либо снятых с производства позиций;
- Оперативные сроки поставки под заказ (от 5 рабочих дней);
- Экспресс доставка в любую точку России;
- Техническая поддержка проекта, помощь в подборе аналогов, поставка прототипов;
- Система менеджмента качества сертифицирована по Международному стандарту ISO 9001;
- Лицензия ФСБ на осуществление работ с использованием сведений, составляющих государственную тайну;
- Поставка специализированных компонентов (Xilinx, Altera, Analog Devices, Intersil, Interpoint, Microsemi, Aeroflex, Peregrine, Syfer, Eurofarad, Texas Instrument, Miteq, Cobham, E2V, MA-COM, Hittite, Mini-Circuits, General Dynamics и др.);

Помимо этого, одним из направлений компании «ЭлектроПласт» является направление «Источники питания». Мы предлагаем Вам помощь Конструкторского отдела:

- Подбор оптимального решения, техническое обоснование при выборе компонента;
- Подбор аналогов;
- Консультации по применению компонента;
- Поставка образцов и прототипов;
- Техническая поддержка проекта;
- Защита от снятия компонента с производства.



#### Как с нами связаться

**Телефон:** 8 (812) 309 58 32 (многоканальный)

**Факс:** 8 (812) 320-02-42

**Электронная почта:** [org@eplast1.ru](mailto:org@eplast1.ru)

**Адрес:** 198099, г. Санкт-Петербург, ул. Калинина, дом 2, корпус 4, литера А.