

# MINI-PS-100-240AC/10-15DC/8

## Primary-Switched Power Supply, Narrow Design



### Data Sheet

08/2004

MINI POWER provides:

- An extra narrow design, with widths of 22.5 mm, 45 mm, and 67.5 mm (0.886, 1.772, and 2.657 in.)
- Global use due to a wide-range input
- A high level of operational safety in complex global networks
- Reliable startup of heavy loads due to POWER BOOST

The reliability of a power supply unit determines the availability of individual components in a system and whether complex systems can function safely.

The globalization of markets increases the demands placed on the power supply unit. A wide-range input and a high level of availability are required. These requirements are met by MINI POWER.

### Short Description

MINI POWER is the extra narrow power supply unit, which is available in widths of 22.5 mm, 45 mm, and 67.5 mm (0.886, 1.772, and 2.657 in.).

In addition to a 24 V version with output currents of 1 A, 2 A, and 4 A, special voltages are also available with 5 V/3 A,  $\pm 15$  V/1 A, and 10 - 15 V/2 A for connection to single-phase AC networks or to two external conductors in three-phase networks with nominal voltages of 100 - 240 V AC. Two DC/DC converters convert low direct voltages into an adjustable and regulated 24 V output voltage.

With the DIN rail bus connector, the MINI-SYS-PS can be connected in parallel to supply other modules in the same system with a regulated 24 V DC voltage.

Reliable startup of heavy loads is ensured by a power reserve of up to 100% – the POWER BOOST.

The high level of operational safety is also ensured in complex global networks. MINI POWER also operates in applications where static voltage dips, transient power supply failures or phase failure are common.

Powerful capacitors ensure mains buffering of more than 20 ms at full load.

### Area of Application

MINI POWER can be used globally due to the consistent provision of a wide-range input.

In this way, your entire system can be tested at any production location in the world and can be delivered to any location in the world without faulty switching of the input voltage. This reduces storage costs and logistical effort.



An international approval package including UL 60950 for IT equipment and UL 508 for industrial control equipment enables the device to be used globally.

## Technical Data

Input Data	
Nominal input voltage (wide-range input)	100 V AC - 240 V AC
Input voltage range	85 V AC - 264 V AC/90 V AC - 350 V DC
Frequency	45 Hz - 65 Hz/0 Hz
Current consumption (for nominal values)	1.3 A (120 V AC)/0.8 A (230 V AC), approximately
Inrush current limiting/ $I^2t$ (+25°C [+77°F])	< 15 A/< 2.1 A <sup>2</sup> s, typical
Mains buffering for a nominal load (typical)	> 20 ms (120 V AC)/> 20 ms (230 V AC)
Switch-on time after applying the mains voltage	< 1 s
Transient surge protection	Varistor
Input fuse, internal (device protection)	T3.15AL250V
Recommended backup fuse	
Circuit breaker	6 A/10 A/16 A
Characteristic (EN 60898)	B

Output Data	
Nominal output voltage $U_N$ /tolerance	12 V DC/±1%
Setting range for the output voltage	10 V DC - 15 V DC
Output current during convection cooling:	
Nominal output current $I_N$	8 A ( $U_{out} = 10$ V DC - 12 V DC)
-25°C to +60°C (-13°F to +140°F)	6.6 A ( $U_{out} = 15$ V DC)
Derating from +60°C (+140°F)	2.5%/K
Short-circuit current limit	≈ 8 A
Startup of unlimited capacitive loads	Yes
Maximum power dissipation No load/nominal load, approximately	2.5 W/12 W
Efficiency (for 230 V AC and nominal values)	> 88%
Residual ripple/switching peaks (20 MHz) (for nominal values)	< 100 mV <sub>S</sub>
Can be connected in parallel	Yes, to increase redundancy and power
Internal surge protection	Yes, < 25 V DC
Resistance to return supply	25 V DC

Signal Output Data	
DC OK (see Figure 1, point 3) active: ( $U_{out} > 10.7$ V DC ≙ high signal)	+12 V/≤20 mA
DC OK LED (see Figure 1, point 5) ( $U_{out} > 10.7$ V DC ≙ LED permanently on)	Green LED

Approvals/Standards	
Electrical equipment of machines (Surge Voltage Category III)	EN 60204
Safety transformers for switched-mode power supply units	EN 61558-2-17
Electrical safety (of IT equipment)	EN 60950/VDE 0805, UL/C-UL Recognized UL 60950 
Industrial control equipment	UL/C-UL Listed UL 508 
Electronic equipment for use in electrical power installations	EN 50178/VDE 0160
Safety extra-low voltage	PELV (EN 60204)/SELV (EN 60950)
Safe isolation	VDE 0100-410
Protection against electric shock, basic requirements for safe isolation in electrical equipment	DIN VDE 0106-101
Limitation of harmonic line currents	According to EN 61000-3-2

General Data	
Insulation voltage input/output	Type test/routine test 3 kV AC/3 kV AC
Degree of protection	IP20
Class of protection (in closed control cabinets)	II
MTBF according to IEC 61709 (SN 29 500)	> 500,000 h
Housing version	Polyamide PA, color green
Dimensions (W x H x D)	67.5 mm x 99 mm x 114.5 mm (2.657 in. x 3.898 in. x 4.508 in.)
Weight	0.4 kg, approximately

Climatic Data	
Ambient temperature	
Operation	-25°C to +70°C (-13°F to +158°F) (> +60°C [+140°F] derating)
Storage	-40°C to +85°C (-40°F to +185°F)
Humidity at +25°C (+77°F), no condensation	≤95%
Vibration according to IEC 60068-2-6	< 15 Hz, amplitude ±2.5 mm 15 Hz - 150 Hz, 2.3g
Shock (in all space directions) according to IEC 60068-2-27	30g
Degree of pollution according to EN 50178	2
Climatic category according to EN 60721	3K3

**MINI-PS-100-240AC/10-15DC/8**

<b>Conformance With EMC Directive 89/336/EEC and Low Voltage Directive 73/23/EEC</b>				
<b>Noise Immunity Test According to EN 61000-6-2<sup>1</sup></b>				
Electrostatic discharge (ESD)	EN 61000-4-2	Criterion B <sup>2</sup>	Housing: Contact discharge: Air discharge:	> Level 3 8 kV 8 kV
Electromagnetic HF field	EN 61000-4-3	Criterion A <sup>3</sup>	Housing: Frequency/field strength:	Level 3 80 MHz - 1000 MHz/ 10 V/m
Fast transients (burst)	EN 61000-4-4	Criterion B <sup>2</sup>	Input: Output: Signal:	4 kV (Level 4) <sup>4</sup> 2 kV (Level 3) <sup>4</sup> 1 kV (Level 2) <sup>4</sup>
Surge current loads (surge)	EN 61000-4-5	Criterion B <sup>2</sup>	Input: Output: Signal:	4 kV <sup>4</sup> /2 kV <sup>5</sup> (Level 4) 0.5 kV <sup>4</sup> /0.5 kV <sup>5</sup> (Level 1) 0.5 kV <sup>4</sup> (Level 1)
Conducted interference	EN 61000-4-6	Criterion A <sup>3</sup>	Input/Output/ Signal: Frequency/U <sub>0</sub> :	(Level 3) <sup>4</sup>  0.15 MHz - 80 MHz/10 V
Voltage dips	EN 61000-4-11	Criterion B <sup>2</sup>	Input: See mains buffering	> 20 ms
<b>Noise Emission Test According to EN 61000-6-3</b>				
Radio interference emission	EN 55011 EN 55022 <sup>6</sup>	Class B <sup>7</sup>		
Radio interference voltage	EN 55011 EN 55022 <sup>6</sup>	Class B <sup>7</sup>		

<sup>1</sup> EN 61000 corresponds to IEC 61000

<sup>2</sup> Criterion B: Temporary adverse effects on the operating characteristics, which the device corrects automatically.

<sup>3</sup> Criterion A: Normal operating characteristics within the specified limits.

<sup>4</sup> Asymmetrical: Cable to ground

<sup>5</sup> Symmetrical: Cable to cable

<sup>6</sup> EN 55011 corresponds to CISPR11, EN 55022 corresponds to CISPR22/EN 61000 corresponds to IEC 61000

<sup>7</sup> Class B: Industrial and domestic applications

## Ordering Data

Description	Order Designation	Order No.
Primary-switched power supply, narrow design	MINI-PS-100-240AC/10-15DC/8	28 66 29 7

## Device View, Connections, and Control Elements

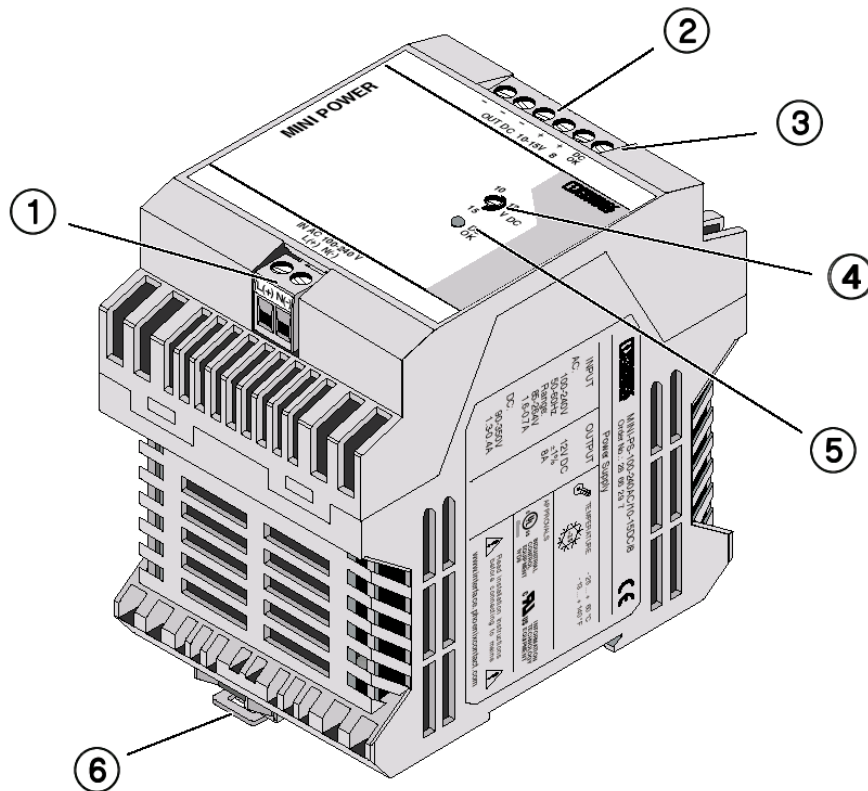

Figure 1 Device connections and control elements

- |   |   |
|---|---|
| <p>1 AC input: Input voltage<br/>85 - 264 V AC, frequency 45 - 65 Hz</p> <p>2 DC output: Output voltage<br/>12 V DC (default), can be set from<br/>10 V DC - 15 V DC using potentiometer</p> <p>3 Active DC OK switching output</p> <p>4 Potentiometer 10 V DC - 15 V DC</p> <p>5 Green DC OK LED</p> | <p>6 Universal latching foot for EN DIN rails</p> |
|---|---|

## Installation

### Safety Notes and Warning Instructions



Installation and startup must only be carried out by qualified personnel. The relevant country-specific regulations (e.g., VDE, DIN) must also be observed.



Before startup it is particularly important to ensure that:

- The mains has been connected correctly and protection is provided against electric shock.
- The device can be switched off outside the power supply according to EN 60950 regulations (e.g., by the line protection on the primary side).
- All supply lines have sufficient fuse protection and are the correct size.
- All output cables are the correct size for the maximum device output current or have separate fuse protection.
- Sufficient convection is ensured.



MINI POWER is a built-in device. After installation the terminal area must be covered to provide sufficient protection against unauthorized access to live parts. This is ensured by installing the device in the control cabinet or distributor box.

## Mounting

**Danger**

Never carry out work when the power is turned on.



To ensure sufficient convection, a minimum spacing of 5 cm (1.969 in.) to other modules is required above and below the device.

### Mounting on the DIN Rail

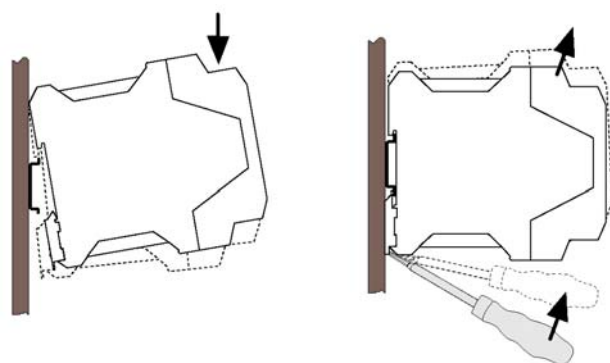

Figure 2 DIN rail mounting/removal

The power supply unit can be snapped onto all 35 mm (1.378 in.) DIN rails according to EN 60715. The device should be mounted horizontally (input terminal blocks facing downwards).

## Connection/Connecting Cable

The device is equipped with COMBICON connectors. This connection method enables quick device connection and visible isolation of the electrical connection, if required.

Use a screwdriver with the correct blade width for wiring.

The following cable cross sections can be connected:



Connectors may only be operated when the power is switched off.

	Solid [mm <sup>2</sup> ]	Stranded [mm <sup>2</sup> ]	AWG	Torque		Stripping Length L [mm]
				[Nm]	[lb in]	
Input/output/signal	0.2 - 2.5	0.2 - 2.5	25 - 14	0.5 - 0.6	4.4 - 5.3	7 mm (0.28 in.)

To maintain UL approvals, use copper cables, which are designed for operating temperatures > +75°C (+167°F).

For reliable and safe-to-touch connections, strip the cable ends according to Figure 3.

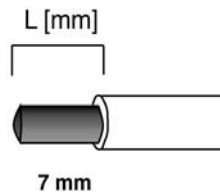

Figure 3 Stripping length

## Block Diagram

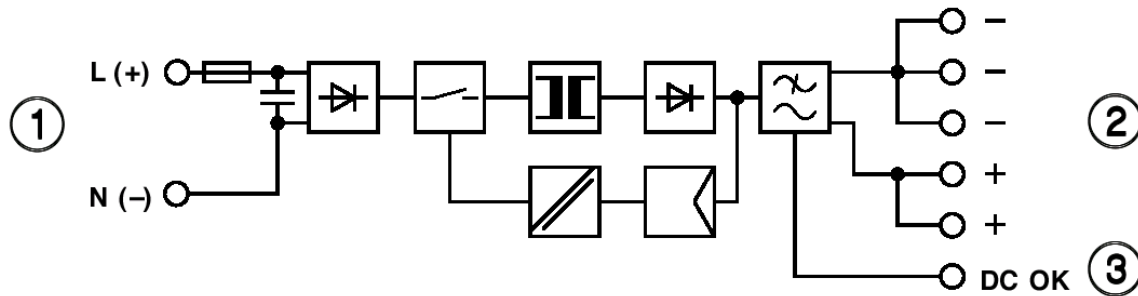

Figure 4 Block diagram

- 1 AC input: Input voltage  
85 - 264 V AC, frequency 45 - 65 Hz
- 2 DC output: Output voltage  
12 V DC (default), can be set from 10 - 15 V DC  
using potentiometer
- 3 Active DC OK switching output



### Input

The 100 - 240 V AC connection is made using connections L and N (see Figure 1, point 1).

The device can be connected to single-phase AC networks or to two external conductors for three-phase networks

(TN, TT or IT network according to VDE 0100-300/IEC 60364-3) with nominal voltages of 100 - 240 V AC (see Figure 5).

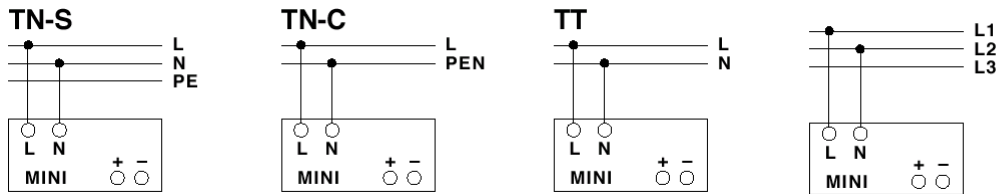





Figure 5 Network types

An **internal fuse** is present for device protection. Additional device protection is not required. The recommended backup fuses are 6 A, 10 A or 16 A circuit breakers, Characteristic B (or equivalent).

- 

A suitable fuse should be provided for DC applications.
- 

An all-pole disconnecting device must be provided for two-phase operation using two external conductors for a three-phase network.
- 

If the internal fuse is blown, this is most probably due to a device fault. In this case, the device should be checked in the factory.

## Output

The 12 V DC connection is made using the "+" and "-" screw connections (see Figure 1, point 2). The output voltage set upon delivery is 12 V DC. The output voltage can be adjusted from 10 to 15 V DC on the potentiometer.

The active DC OK switching output (see Figure 1, point 3) is connected using the "DC OK" and "-" screw connections.

The device is electronically short-circuit-proof and idling-proof. In the event of an error, the output voltage is limited to a maximum of 25 V DC.

### Output Characteristic Curve

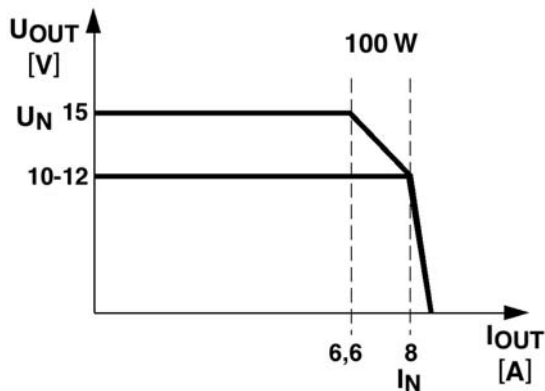

Figure 6 Output characteristic curve

The device operates according to the U/I characteristic curve. With a load, the working point demonstrates this curve. On an overload or short circuit, the output current is limited to 8 A. The secondary voltage is reduced until the overload or the short circuit on the secondary side is removed.

### Temperature Response

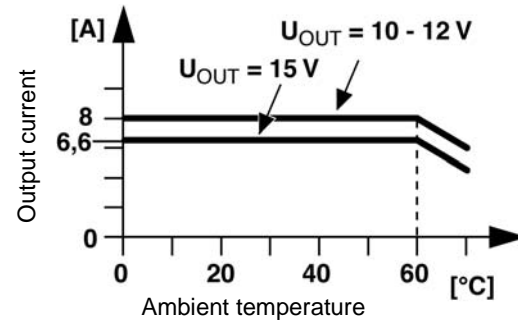

Figure 7 Temperature response

The output power must be decreased by 2.5% per Kelvin temperature increase for ambient temperatures over +60°C (+140°F).

At ambient temperatures above +70°C (+158°F) or in the event of a thermal overload, the device reduces the output power to protect itself and returns to normal operation once it has cooled down.

### Signaling

The active DC OK switching output (see Figure 1, point 3) and the DC OK LED (see Figure 1, point 5) provide function monitoring.

	Status 1	Status 2
<b>Green "DC OK" LED</b>	<b>ON</b>	<b>OFF</b>
<b>Active DC OK switching output</b>	U = +12 V (with reference to "-")	U = 0 V (with reference to "-")
<b>Meaning</b>	Normal operation of the power supply unit U <sub>OUT</sub> > 10.8 V	U <sub>OUT</sub> ≤ 10.8 V DC - Secondary load short circuit or overload - No mains voltage or device fault

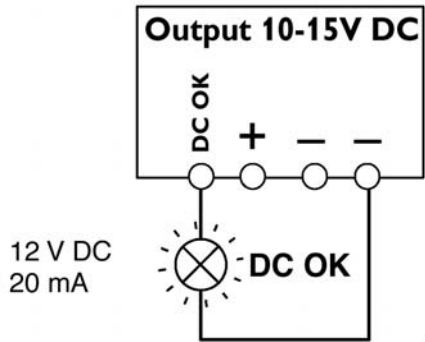

Figure 8 DC OK function monitoring

## Parallel and Redundancy Operation

### Parallel Operation



A maximum of five devices can be connected in parallel.

Devices of the same type can be connected in parallel to increase both redundancy and power. The default setting does not have to be adjusted.

If the output voltage is adjusted, an even current distribution can be ensured by precisely setting all power supplies that are operated in parallel to the same output voltage.



To ensure symmetrical current distribution we recommend that all cable connections from the power supply unit to the DIN rail are the same length and have the same cross section.

Depending on the system, for parallel connection of more than two power supply units a protective circuit should be installed at each individual device output (e.g., decoupling diode or DC fuse). This prevents high return currents in the event of a secondary device fault.

### Redundancy Operation

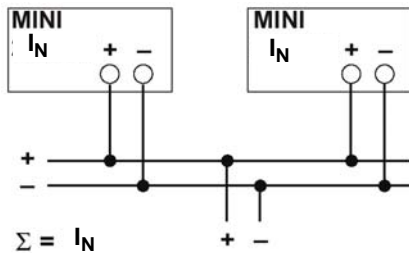

Figure 9 Redundancy operation

Redundant connections are designed for supplying systems, which place particularly high requirements on operational safety. If a fault occurs in the primary circuit of the first power supply unit, the second device

automatically takes over the complete power supply without interruption, and vice versa.

For this purpose, the power supply units to be connected in parallel must be large enough that the total current requirements of all loads can be fully met by one power supply unit.



External decoupling diodes are required for 100% redundancy.

### Increasing Power

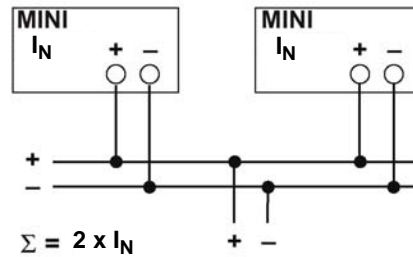

Figure 10 Increasing power



A maximum of five devices can be connected in parallel.

The output current can be increased to  $n \times I_N$  where  $n$  is the number of devices connected in parallel.

Parallel connection for increasing power is used when extending existing systems.

A parallel connection is recommended if the power supply unit does not cover the current consumption of the most powerful load. Otherwise, the loads should be divided over independent individual devices.



Make sure you always use the latest documentation.  
It can be downloaded from [www.phoenixcontact.com](http://www.phoenixcontact.com).

Phoenix Contact GmbH & Co. KG  
Flachmarktstr. 8  
32825 Blomberg  
Germany



+49 - 52 35 - 30 0



+49 - 52 35 - 34 12 00



[www.phoenixcontact.com](http://www.phoenixcontact.com)



Worldwide Locations:

[www.phoenixcontact.com/salesnetwork](http://www.phoenixcontact.com/salesnetwork)



Компания «ЭлектроПласт» предлагает заключение долгосрочных отношений при поставках импортных электронных компонентов на взаимовыгодных условиях!

Наши преимущества:

- Оперативные поставки широкого спектра электронных компонентов отечественного и импортного производства напрямую от производителей и с крупнейших мировых складов;
- Поставка более 17-ти миллионов наименований электронных компонентов;
- Поставка сложных, дефицитных, либо снятых с производства позиций;
- Оперативные сроки поставки под заказ (от 5 рабочих дней);
- Экспресс доставка в любую точку России;
- Техническая поддержка проекта, помощь в подборе аналогов, поставка прототипов;
- Система менеджмента качества сертифицирована по Международному стандарту ISO 9001;
- Лицензия ФСБ на осуществление работ с использованием сведений, составляющих государственную тайну;
- Поставка специализированных компонентов (Xilinx, Altera, Analog Devices, Intersil, Interpoint, Microsemi, Aeroflex, Peregrine, Syfer, Eurofarad, Texas Instrument, Miteq, Cobham, E2V, MA-COM, Hittite, Mini-Circuits, General Dynamics и др.);

Помимо этого, одним из направлений компании «ЭлектроПласт» является направление «Источники питания». Мы предлагаем Вам помощь Конструкторского отдела:

- Подбор оптимального решения, техническое обоснование при выборе компонента;
- Подбор аналогов;
- Консультации по применению компонента;
- Поставка образцов и прототипов;
- Техническая поддержка проекта;
- Защита от снятия компонента с производства.



#### Как с нами связаться

**Телефон:** 8 (812) 309 58 32 (многоканальный)

**Факс:** 8 (812) 320-02-42

**Электронная почта:** [org@eplast1.ru](mailto:org@eplast1.ru)

**Адрес:** 198099, г. Санкт-Петербург, ул. Калинина, дом 2, корпус 4, литера А.