

# UM10522

## TEA1721 non-isolated universal mains buck and buck/boost converter demo board

Rev. 1.1 — 19 December 2012

User manual

### Document information

Info	Content
<b>Keywords</b>	TEA1721XT, non-isolated, universal mains, buck, buck/boost, AC/DC conversion, Switched Mode Power Supply (SMPS)
<b>Abstract</b>	This user manual describes a +12 V AC/DC buck and –12 V AC/DC non-isolated buck/boost-mode SMPS that can be used to supply up to 2.5 W into a load.



## Revision history

Rev	Date	Description
v.1.1	20121219	second issue
v.1	20120308	first issue

## Contact information

For more information, please visit: <http://www.nxp.com>

For sales office addresses, please send an email to: [salesaddresses@nxp.com](mailto:salesaddresses@nxp.com)

## 1. Introduction

### WARNING

#### Lethal voltage and fire ignition hazard



The non-insulated high voltages that are present when operating this product, constitute a risk of electric shock, personal injury, death and/or ignition of fire.

This product is intended for evaluation purposes only. It shall be operated in a designated test area by personnel qualified according to local requirements and labor laws to work with non-insulated mains voltages and high-voltage circuits. This product shall never be operated unattended.

This user manual describes a +12 V AC/DC buck and –12 V AC/DC non-isolated buck/boost-mode SMPS that can be used to supply up to 2.5 W into a load.

The switch mode converter operates at a maximum frequency of around 50 kHz.

Overcurrent and short-circuit protection are built in. Under no-load conditions, the power consumption of this converter is in the range of 10 mW. EMI filtering and (optional) surge voltage protection using TVS diodes is implemented in this circuit.

This application is a general purpose non-isolated SMPS.

In applications where triacs are driven in the third quadrant (such as white goods applications), the negative output voltage with respect to Neutral or Phase makes buck/boost converters particularly interesting.

The optional surge protection makes it suitable for use in environments where serious voltage transients can occur. The absolute maximum RMS mains input voltage is 280 V (AC).

### 1.1 Features and benefits

- Compatible with Universal Mains
- Inrush current limitation
- EMI filtering to meet EMC requirements of EN55022
- Surge input voltage protection

## 2. Safety Warning

The demo board is powered by AC mains voltage. Avoid touching the board when power is applied. An isolated housing is obligatory when used in uncontrolled, non-laboratory environments.

### 3. Specification

**Table 1. Demo board specification**

Parameter	Value	Comment
AC line input voltage	85 V (AC) to 265 V (AC)	supplied to J1.1 (phase) and J1.2 (neutral) terminals
Output voltages	buck converter mode: 12 V (DC)	supplied from connectors: J2.1 = 12 V J2.2 = 0 V <sup>[1]</sup>
	buck/boost converter mode: -12 V (DC)	supplied from connectors: J2.1 = 0 V J2.2 = -12 V <sup>[2]</sup>
Maximum output current	buck converter mode: 200 mA	-
	buck/boost converter mode: -200 mA	-
Maximum output power	2.5 W	-
Output voltage accuracy	+2 % to -5 %	-
Output voltage stability	≥ ± 1 %	in load range 10 % to 100 %
Efficiency	± 77 % at 100 % load	-
Operating temperature	-40 °C to 85 °C	-
EMC Compliance	EN 55022	-
Board dimensions	34.3 mm × 34.3 mm × 25 mm	L × B × H

[1] J2.2 is at the same potential as J1.2.

[2] J2.1 is at the same potential as J1.2.

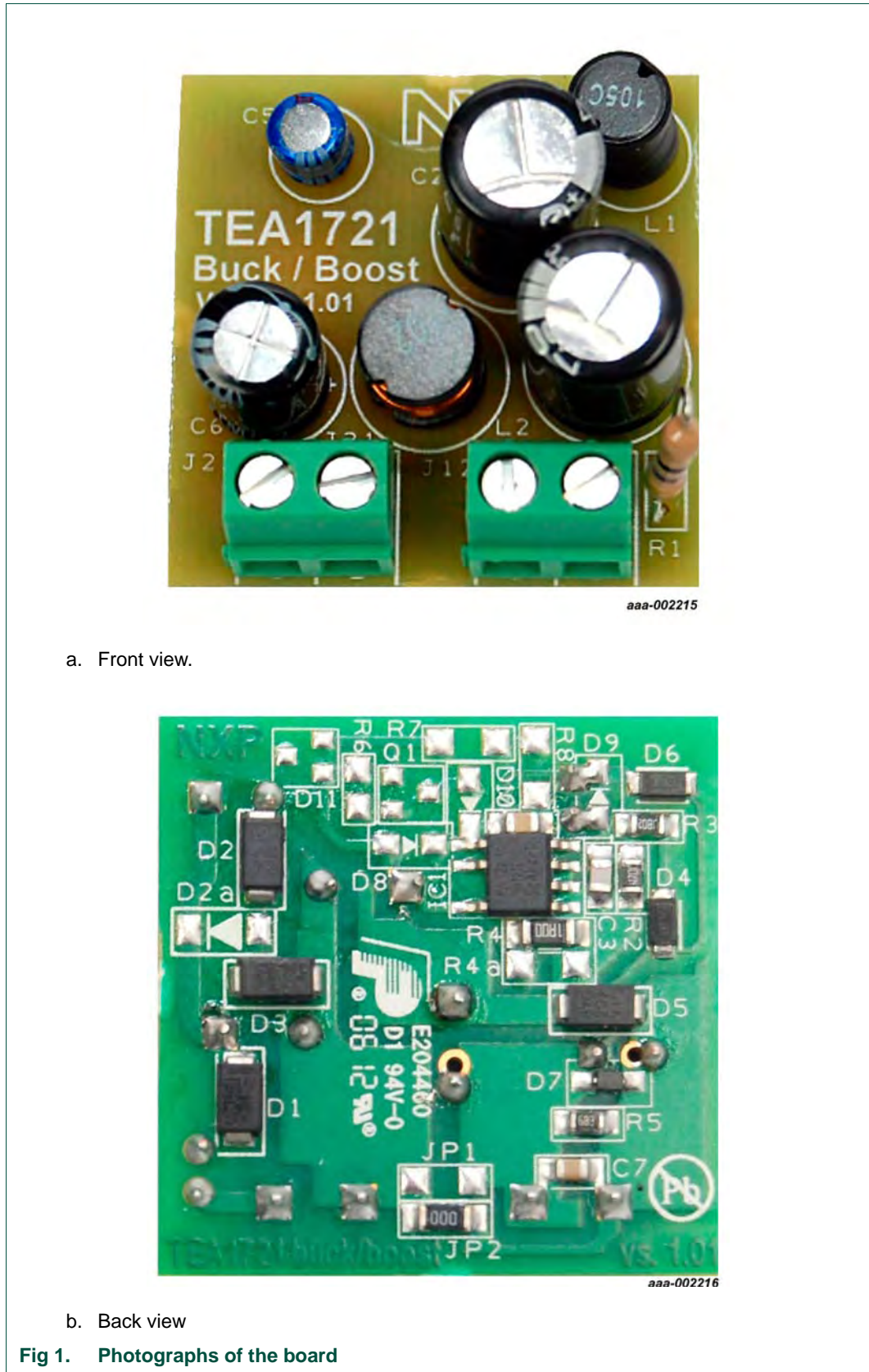

### 4. Demo board connections

**Remark:** Mount the board in a shielded or isolated box for demonstration purposes.

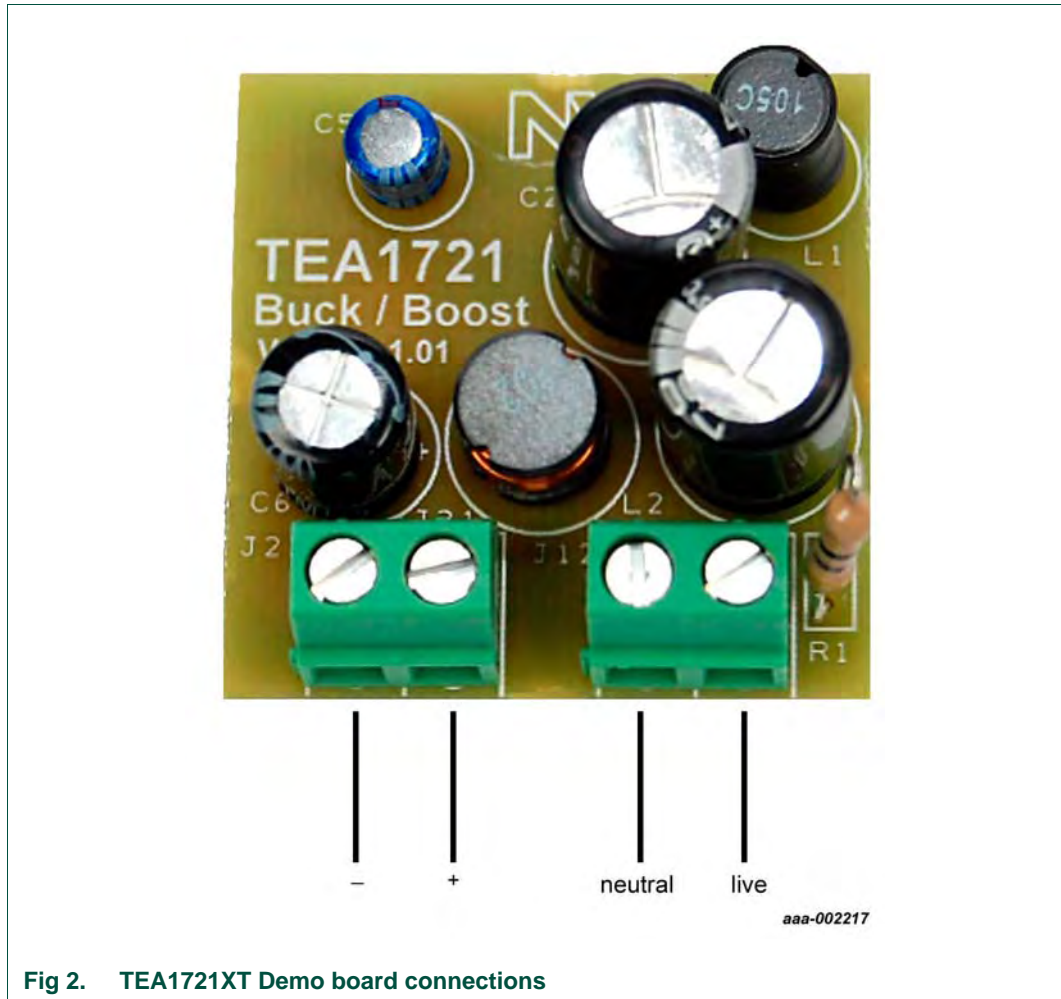

Fig 2. TEA1721XT Demo board connections

## 5. Operation and performance

Basic operation of the IC is described in the *TEA1721 data sheets*.

### 5.1 No-load power consumption

Table 2. Typical no-load power consumption

Power supply	Energy Star 2.0 requirement	No-load power consumption
115 V (AC)/60 Hz	<300 mW	± 5 mW
230 V (AC)/50 Hz	<300 mW	± 8 mW

The typical no-load power consumption of the TEA1721 universal mains buck/boost converter exceeds the Energy Star 2.0 level V requirement by approximately two orders of magnitude.

### 5.2 Efficiency

Table 3. Buck mode typical efficiency data

Parameter	Energy Star 2.0 level V (%)	Efficiency (%)				
		average	25 % load	50 % load	75 % load	100 % load
115 V (AC)/60 Hz	67.9	80	81.2	80.4	79.3	79.1
230 V (AC)/50 Hz	67.9	78.7	77.6	78.9	79	79.1

Table 4. Buck/boost mode typical efficiency data

Parameter	Energy Star 2.0 level V (%)	Efficiency (%)				
		average	25 % load	50 % load	75 % load	100 % load
115 V (AC)/60 Hz	67.9	78.2	79.5	78.7	77.6	76.8
230 V (AC)/50 Hz	67.9	77.3	76.7	78	77.1	77.5

The typical efficiency of the TEA1721 universal mains buck/boost converter exceeds the Energy Star 2.0 level V requirement by approximately 10 % on average.

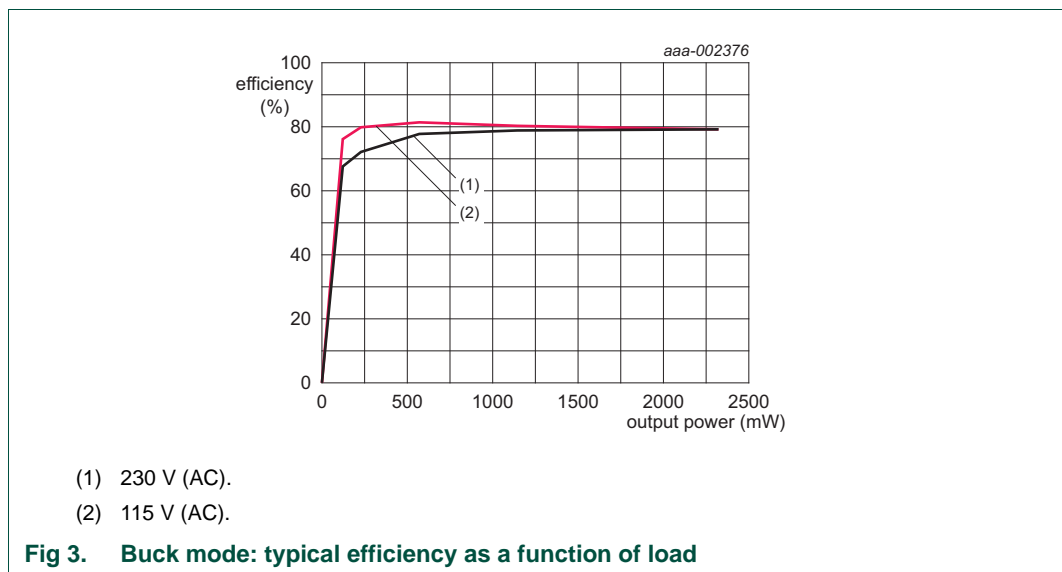

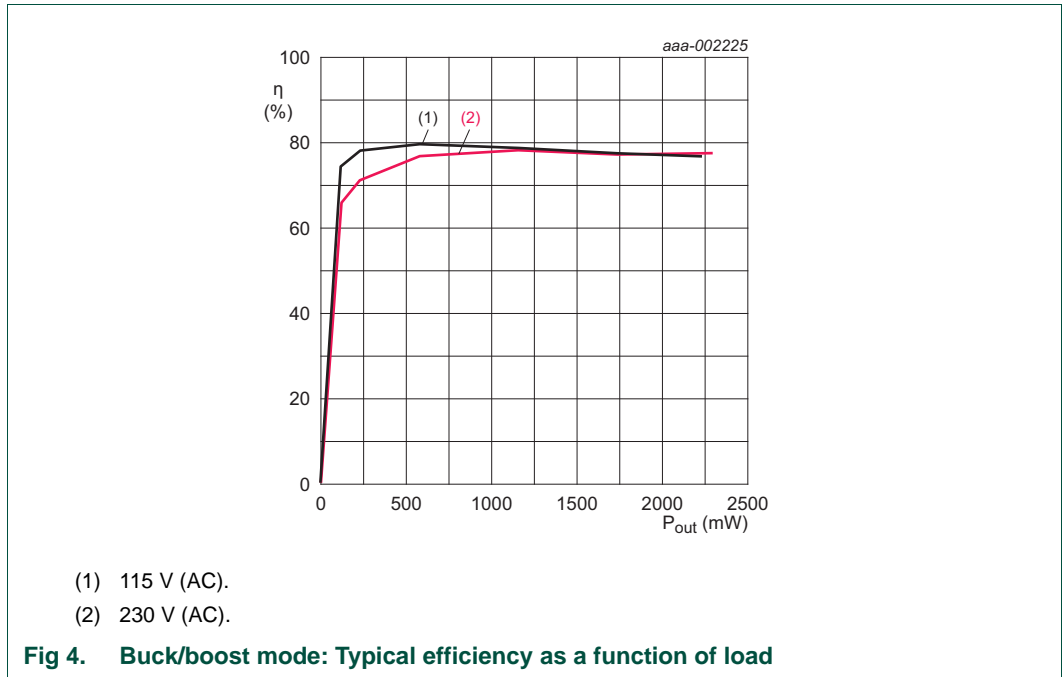

### 5.3 Output voltage stability

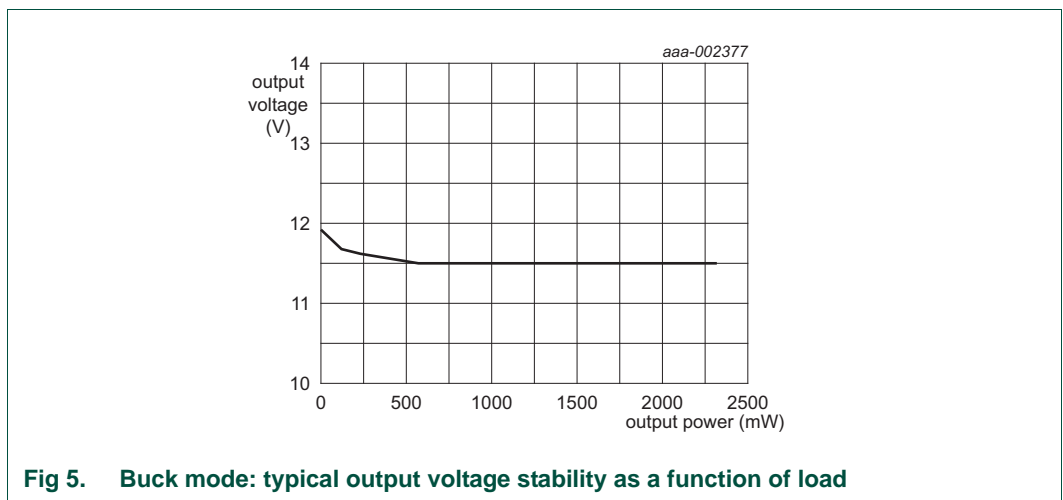



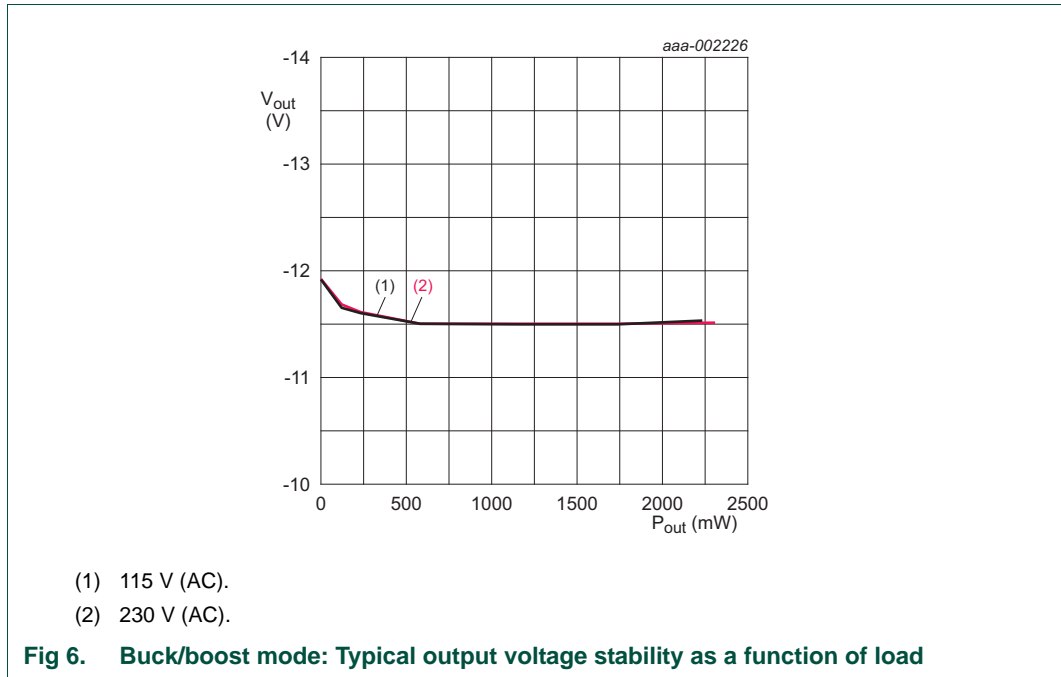

## 6. Test results

### 6.1 ElectroMagnetic Interference

The TEA1721 buck and buck/boost mode converter application meets the requirements of EN55022. There is a margin of at least 10 dB with respect to the formal limits.

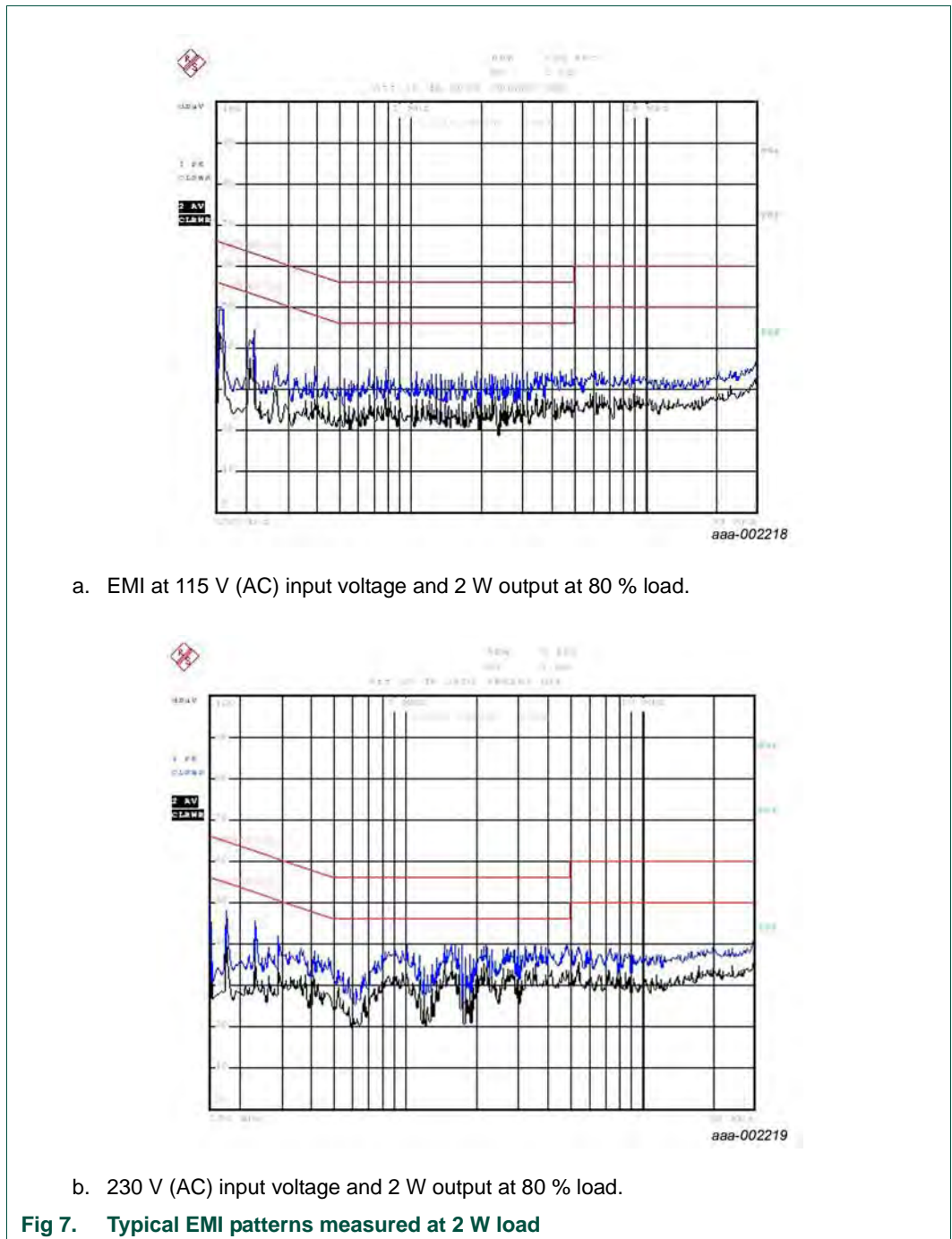

### 7. Demo board schematic

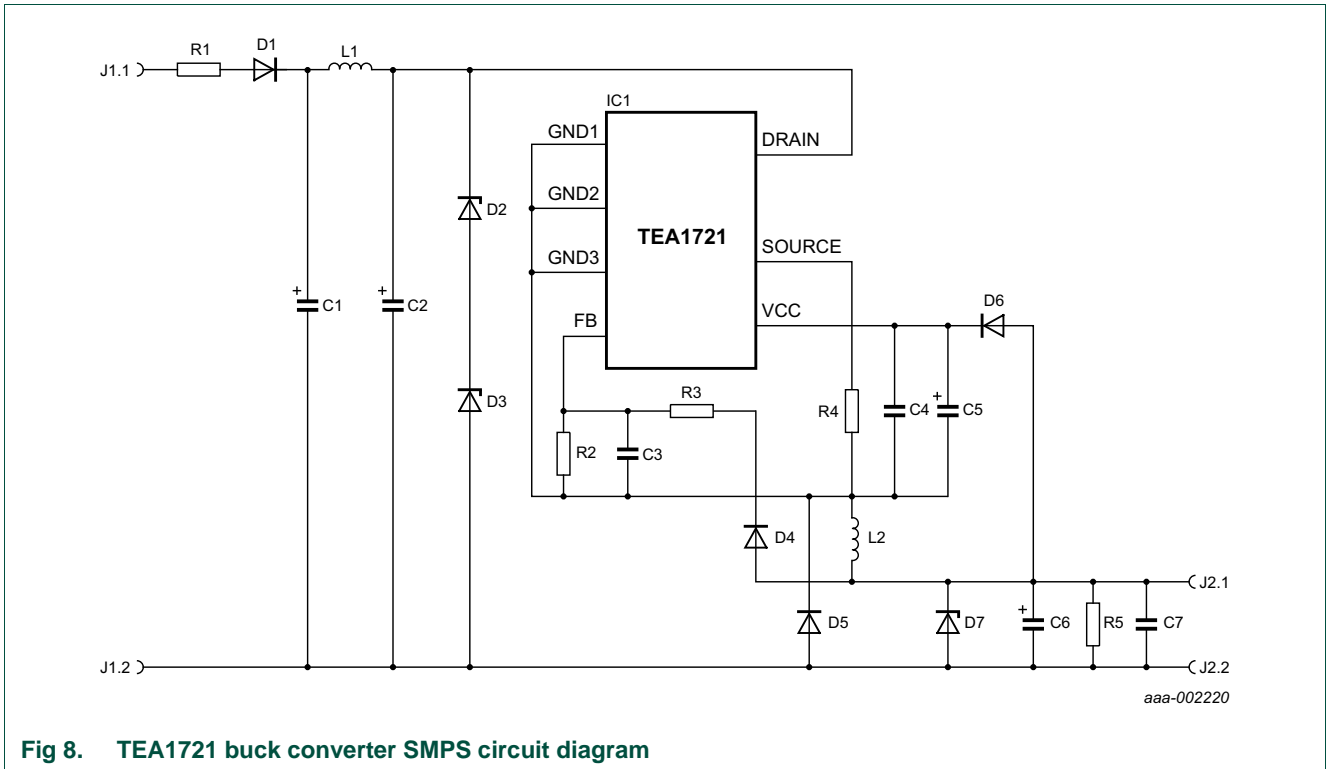

Fig 8. TEA1721 buck converter SMPS circuit diagram

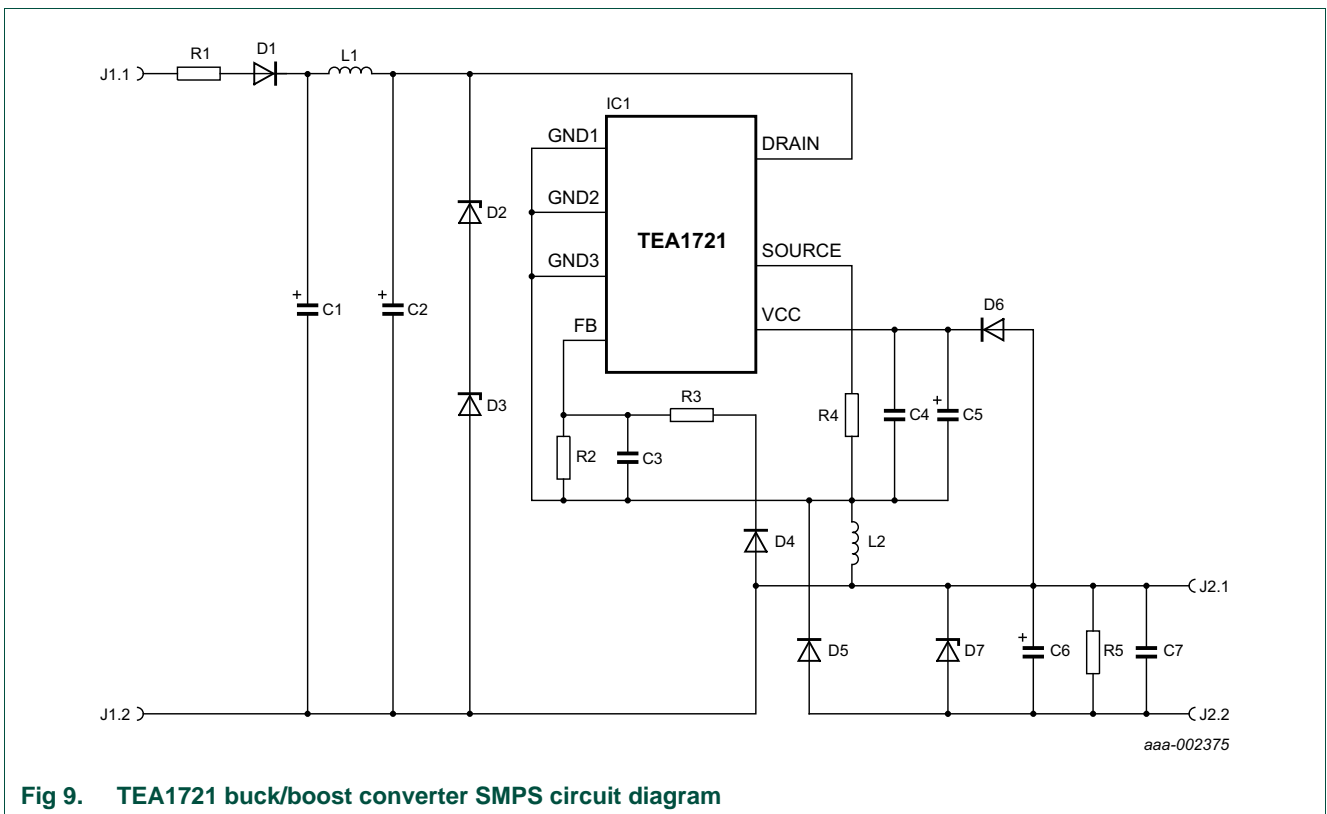

Fig 9. TEA1721 buck/boost converter SMPS circuit diagram

## 8. PCB components

Table 5. Demo board components

Reference	Description and value	Part number	Manufacturer
C1	electrolytic capacitor; 4.7 $\mu$ F; 400 V	-	-
C2	electrolytic capacitor; 4.7 $\mu$ F; 400 V	-	-
C3	capacitor; 10 pF; 25 V	-	-
C4	capacitor; 100 nF; 50 V	-	-
C5	electrolytic capacitor; 10 $\mu$ F; 35 V	-	-
C6	electrolytic capacitor; 470 $\mu$ F; 16 V	-	-
C7	capacitor; 100 nF; 50 V	-	-
D1	diode; S1M; SMA	-	-
D2	diode; BZG03-C200; optional see text; SMA	BZG03-C200	-
D3	diode; BZG03-C200; optional see text; SMA	BZG03-C200	-
D4	diode; ES1JL; SMF	-	-
D5	diode; BYG20J; SMA	BYG20J	-
D6	diode; ES1JL; SMF	-	-
D7	diode; BZX384-B12; SOD323	BZX384-B12	NXP Semiconductors
IC1	TEA1721; SO7	-	NXP Semiconductors
JP1	jumper; 0 $\Omega$ ; must be installed for buck/boost mode operation	-	-
JP2	jumper; 0 $\Omega$ installed; must be installed for buck mode only operation	-	-
L1	1 mH; 80 mA	-	-
L2	1 mH; 250 mA (RMS); $I_{sat} = 500$ mA	-	-
R1	carbon resistor; 47 $\Omega$	-	-
R2	resistor; 4.7 k $\Omega$ ; 1 %	-	-
R3	resistor; 18 k $\Omega$ ; 1 % <sup>[1]</sup>	-	-
R4	resistor; 1 $\Omega$ ; 0.25 W	-	-
R5	resistor; 68 k $\Omega$	-	-

[1] To set the output voltage with greater accuracy, fine-tuning is required.

## 9. Implementation guidelines

- The output voltage is adjusted using resistors R2 and R3. In Buck mode, the converter can be used to generate an output voltage between +12 V (DC) and +32 V (DC). In buck/boost mode, the output voltage is between -12 V (DC) and -32 V (DC).
- The maximum output power and output current levels are adjusted using resistor R4. The maximum current allowed in the TEA1721 IC switching MOSFET is 700 mA. Take care that under no circumstance, the peak current in inductor L2 exceeds 700 mA.
- Resistor R1 limits the inrush current. The resistor must be a carbon resistor because metal film resistors can act as a fuse in this position. If no inrush current limiting is required, the resistor can be replaced with a short-circuit.
- EMI filtering is implemented using a single differential stage (C1-L1-C2). Mount additional film capacitors in parallel with C1 and C2 for improved HF noise suppression.
- Surge voltage protection is implemented using TVS diodes D2 and D3. The surge protection limits the DC bus voltage to 400 V maximum. The TVS diodes choice determines the maximum allowable surge pulse energy. The surge protection feature is optional. When not needed diodes D2 and D3 can be eliminated
- To cope with negative voltage surge pulses, diode D1 must be capable of handling a certain amount of avalanche surge energy. The presence of resistor R1 helps to limit any avalanche surge current in diode D1.
- Capacitors C4 and C5 can be replaced with a single (SMD) 2.2  $\mu$ F ceramic capacitor with the appropriate voltage rating. Though more expensive, it needs less board space.
- Resistor R5 forms a small pre-load for the converter. When the output voltages are adjusted, also adjust the pre-load resistors to ensure that they consume roughly the same amount of power. Depending on the connected load, the pre-load resistor can be eliminated.
- Zener diode D7 is an elementary output OverVoltage Protection (OVP). When OVP is not needed, eliminate the diode.
- Capacitor C7 is used to obtain additional (HF) voltage stability and noise suppression. Eliminate the capacitor when the feature is not needed.

### 10. Board layout

The 34.3 mm × 34.3 mm evaluation PCB accommodates either a TEA1721 buck or buck/boost mode application implementation. This board can be used for the particular application shown in the circuit diagram and the associated component list.

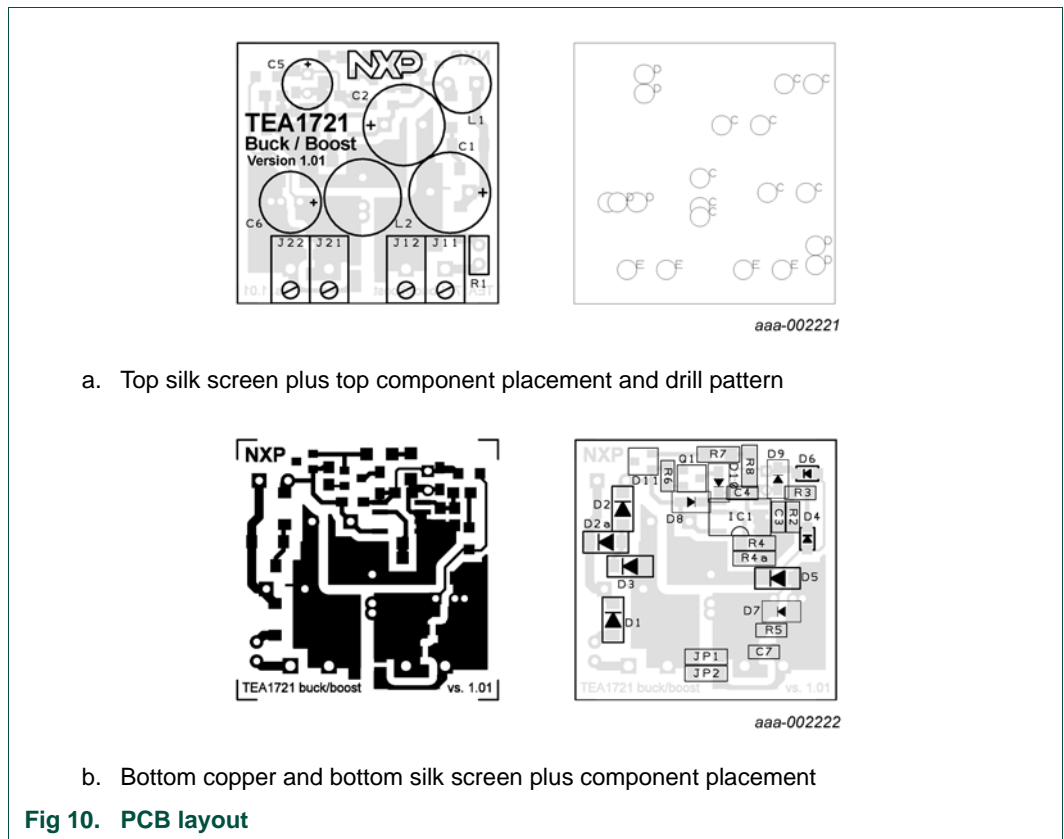

The bottom silk screen is normally not used in PCB production. Merged with the bottom copper, it is shown here as a component placement reference only. Populate all component positions in this application. See [Table 5](#) for a list of components.

**Table 6. Drill tool table**

Drill tool code	Drill diameter
C	1 mm
D	0.9 mm
E	1.3 mm

## 11. References

---

- [1] **TEA1721XT** - Ultra-low standby SMPS controller with integrated power switch
- [2] **AN11060** - TEA172X 5 W to 11 W power supply/USB charger

## 12. Legal information

### 12.1 Definitions

**Draft** — The document is a draft version only. The content is still under internal review and subject to formal approval, which may result in modifications or additions. NXP Semiconductors does not give any representations or warranties as to the accuracy or completeness of information included herein and shall have no liability for the consequences of use of such information.

### 12.2 Disclaimers

**Limited warranty and liability** — Information in this document is believed to be accurate and reliable. However, NXP Semiconductors does not give any representations or warranties, expressed or implied, as to the accuracy or completeness of such information and shall have no liability for the consequences of use of such information. NXP Semiconductors takes no responsibility for the content in this document if provided by an information source outside of NXP Semiconductors.

In no event shall NXP Semiconductors be liable for any indirect, incidental, punitive, special or consequential damages (including - without limitation - lost profits, lost savings, business interruption, costs related to the removal or replacement of any products or rework charges) whether or not such damages are based on tort (including negligence), warranty, breach of contract or any other legal theory.

Notwithstanding any damages that customer might incur for any reason whatsoever, NXP Semiconductors' aggregate and cumulative liability towards customer for the products described herein shall be limited in accordance with the *Terms and conditions of commercial sale* of NXP Semiconductors.

**Right to make changes** — NXP Semiconductors reserves the right to make changes to information published in this document, including without limitation specifications and product descriptions, at any time and without notice. This document supersedes and replaces all information supplied prior to the publication hereof.

**Suitability for use** — NXP Semiconductors products are not designed, authorized or warranted to be suitable for use in life support, life-critical or safety-critical systems or equipment, nor in applications where failure or malfunction of an NXP Semiconductors product can reasonably be expected to result in personal injury, death or severe property or environmental damage. NXP Semiconductors and its suppliers accept no liability for inclusion and/or use of NXP Semiconductors products in such equipment or applications and therefore such inclusion and/or use is at the customer's own risk.

**Applications** — Applications that are described herein for any of these products are for illustrative purposes only. NXP Semiconductors makes no representation or warranty that such applications will be suitable for the specified use without further testing or modification.

Customers are responsible for the design and operation of their applications and products using NXP Semiconductors products, and NXP Semiconductors accepts no liability for any assistance with applications or customer product design. It is customer's sole responsibility to determine whether the NXP Semiconductors product is suitable and fit for the customer's applications and products planned, as well as for the planned application and use of customer's third party customer(s). Customers should provide appropriate design and operating safeguards to minimize the risks associated with their applications and products.

NXP Semiconductors does not accept any liability related to any default, damage, costs or problem which is based on any weakness or default in the customer's applications or products, or the application or use by customer's third party customer(s). Customer is responsible for doing all necessary testing for the customer's applications and products using NXP Semiconductors products in order to avoid a default of the applications and the products or of the application or use by customer's third party customer(s). NXP does not accept any liability in this respect.

**Export control** — This document as well as the item(s) described herein may be subject to export control regulations. Export might require a prior authorization from competent authorities.

**Evaluation products** — This product is provided on an "as is" and "with all faults" basis for evaluation purposes only. NXP Semiconductors, its affiliates and their suppliers expressly disclaim all warranties, whether express, implied or statutory, including but not limited to the implied warranties of non-infringement, merchantability and fitness for a particular purpose. The entire risk as to the quality, or arising out of the use or performance, of this product remains with customer.

In no event shall NXP Semiconductors, its affiliates or their suppliers be liable to customer for any special, indirect, consequential, punitive or incidental damages (including without limitation damages for loss of business, business interruption, loss of use, loss of data or information, and the like) arising out of the use of or inability to use the product, whether or not based on tort (including negligence), strict liability, breach of contract, breach of warranty or any other theory, even if advised of the possibility of such damages.

Notwithstanding any damages that customer might incur for any reason whatsoever (including without limitation, all damages referenced above and all direct or general damages), the entire liability of NXP Semiconductors, its affiliates and their suppliers and customer's exclusive remedy for all of the foregoing shall be limited to actual damages incurred by customer based on reasonable reliance up to the greater of the amount actually paid by customer for the product or five dollars (US\$5.00). The foregoing limitations, exclusions and disclaimers shall apply to the maximum extent permitted by applicable law, even if any remedy fails of its essential purpose.

### 12.3 Trademarks

Notice: All referenced brands, product names, service names and trademarks are the property of their respective owners.



## 13. Contents

---

<b>1</b>	<b>Introduction</b> .....	<b>3</b>
1.1	Features and benefits .....	3
<b>2</b>	<b>Safety Warning</b> .....	<b>3</b>
<b>3</b>	<b>Specification</b> .....	<b>4</b>
<b>4</b>	<b>Demo board connections</b> .....	<b>6</b>
<b>5</b>	<b>Operation and performance</b> .....	<b>7</b>
5.1	No-load power consumption .....	7
5.2	Efficiency .....	7
5.3	Output voltage stability .....	8
<b>6</b>	<b>Test results</b> .....	<b>10</b>
6.1	ElectroMagnetic Interference .....	10
<b>7</b>	<b>Demo board schematic</b> .....	<b>11</b>
<b>8</b>	<b>PCB components</b> .....	<b>12</b>
<b>9</b>	<b>Implementation guidelines</b> .....	<b>13</b>
<b>10</b>	<b>Board layout</b> .....	<b>14</b>
<b>11</b>	<b>References</b> .....	<b>15</b>
<b>12</b>	<b>Legal information</b> .....	<b>16</b>
12.1	Definitions .....	16
12.2	Disclaimers .....	16
12.3	Trademarks .....	16
<b>13</b>	<b>Contents</b> .....	<b>17</b>

---

Please be aware that important notices concerning this document and the product(s) described herein, have been included in section 'Legal information'.

---

© NXP B.V. 2012.

All rights reserved.

For more information, please visit: <http://www.nxp.com>

For sales office addresses, please send an email to: [salesaddresses@nxp.com](mailto:salesaddresses@nxp.com)

Date of release: 19 December 2012

Document identifier: UM10522



Компания «ЭлектроПласт» предлагает заключение долгосрочных отношений при поставках импортных электронных компонентов на взаимовыгодных условиях!

Наши преимущества:

- Оперативные поставки широкого спектра электронных компонентов отечественного и импортного производства напрямую от производителей и с крупнейших мировых складов;
- Поставка более 17-ти миллионов наименований электронных компонентов;
- Поставка сложных, дефицитных, либо снятых с производства позиций;
- Оперативные сроки поставки под заказ (от 5 рабочих дней);
- Экспресс доставка в любую точку России;
- Техническая поддержка проекта, помощь в подборе аналогов, поставка прототипов;
- Система менеджмента качества сертифицирована по Международному стандарту ISO 9001;
- Лицензия ФСБ на осуществление работ с использованием сведений, составляющих государственную тайну;
- Поставка специализированных компонентов (Xilinx, Altera, Analog Devices, Intersil, Interpoint, Microsemi, Aeroflex, Peregrine, Syfer, Eurofarad, Texas Instrument, Miteq, Cobham, E2V, MA-COM, Hittite, Mini-Circuits, General Dynamics и др.);

Помимо этого, одним из направлений компании «ЭлектроПласт» является направление «Источники питания». Мы предлагаем Вам помощь Конструкторского отдела:

- Подбор оптимального решения, техническое обоснование при выборе компонента;
- Подбор аналогов;
- Консультации по применению компонента;
- Поставка образцов и прототипов;
- Техническая поддержка проекта;
- Защита от снятия компонента с производства.



#### Как с нами связаться

**Телефон:** 8 (812) 309 58 32 (многоканальный)

**Факс:** 8 (812) 320-02-42

**Электронная почта:** [org@eplast1.ru](mailto:org@eplast1.ru)

**Адрес:** 198099, г. Санкт-Петербург, ул. Калинина, дом 2, корпус 4, литера А.