

1-channel High Side Switch

■ GENERAL DESCRIPTION

The NJW4832 is the single high-side switch that can supply 0.2A. The active clamp circuit, overcurrent and thermal shutdown are built-in to Pch MOS FET.

A logic signal (3V/5V) can be input directly. Especially, the NJW4832 is suitable for various Sensors output block as PNP type. The FLT logic has two versions: Active-high (A-ver) and Active-low (B-ver).

Also, The NJW4832 is a complementary product to the NJW4822.

■ PACKAGE OUTLINE

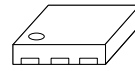

NJW4832KH1

■ FEATURES

- Drain-Source Voltage 45V
- Output Current 0.2A
- Corresponding with Logic Voltage Operation: 3V/5V
- Low On-Resistance 0.75Ω (typ.)
- Low Consumption Current 110μA (typ.)
- Active Clamp Circuit
- Over Current Protection (Self recovery type current limiting function)
- Thermal Shutdown
- Package Outline DFN6-H1 (ESON6-H1)

■ PIN CONFIGURATION

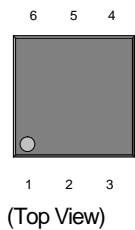

1. VDD
2. NC
3. OUT
4. IN
5. GND
6. FLT

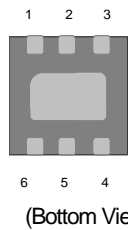

Exposed PAD on backside connect to GND.

■ BLOCK DIAGRAM

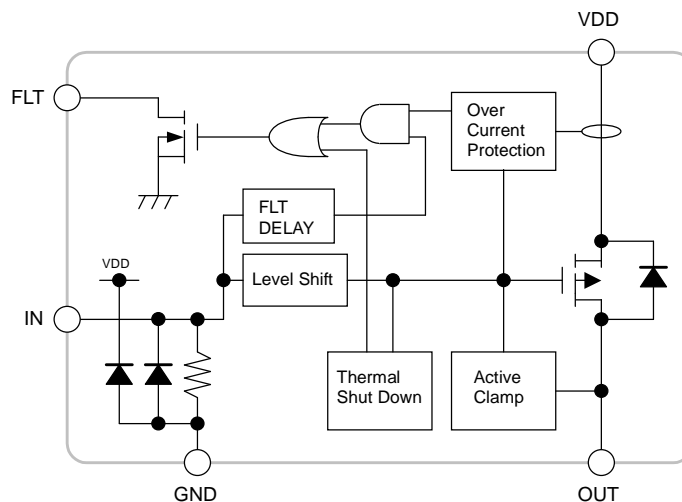

NJW4832

■ ABSOLUTE MAXIMUM RATINGS

(Ta=25°C)

PARAMETER	SYMBOL	RATINGS	UNIT	REMARK
Drain-Source Voltage	V_{DS}	45	V	VDD-OUT Pin
Supply Voltage	V_{DD}	45	V	VDD-GND Pin
Input Pin Voltage	V_{IN}	-0.3 to +6	V	IN-GND Pin
FLT Pin Voltage	V_{FLT}	-0.3 to +6	V	FLT-GND Pin
Power Dissipation	P_D	445 (*1) 1135 (*2)	mW	-
Active Clamp Tolerance (Single Pulse)	E_{AS}	100	mJ	-
Active Clamp Current	I_{AP}	0.2	A	-
Junction Temperature	T_j	-40 to +150	°C	-
Operating Temperature	T_{opr}	-40 to +125	°C	-
Storage Temperature	T_{stg}	-50 to +150	°C	-

(*1): Mounted on glass epoxy board (101.5×114.5×1.6mm: based on EIA/JEDEC standard, 2Layers FR-4, with Exposed Pad)

(*2): Mounted on glass epoxy board (101.5×114.5×1.6mm: based on EIA/JEDEC standard, 4Layers FR-4, with Exposed Pad)
(4Layers: Applying 99.5×99.5mm inner Cu area and a thermal via hole to a board based on JEDEC standard JESD51-5)

■ RECOMMENDED OPERATING CONDITIONS

(Ta=25°C)

PARAMETER	SYMBOL	MIN.	TYP.	MAX.	UNIT	REMARK
Drain-Source Voltage	V_{DS}	0	-	40	V	VDD-OUT Pin
Supply Voltage	V_{DD}	4.6	-	40	V	VDD-GND Pin
Output Current	I_O	0	-	0.2	A	VDD-OUT Pin
Input Pin Voltage	V_{IN}	0	-	5.5	V	IN-GND Pin
FLT Pin Voltage	V_{FLT}	0	-	5.5	V	FLT-GND Pin

■ PRODUCT VERSION

PRODUCT NAME	FLT LOGIC
NJW4832KH1-A	Active High
NJW4832KH1-B	Active Low

■ ELECTRICAL CHARACTERISTICS

(Unless otherwise noted, $V_{DS}=13V$, $T_a=25^{\circ}C$)

PARAMETER	SYMBOL	CONDITIONS	MIN.	TYP.	MAX.	UNIT
Drain-Source Clamp Voltage	V_{DSS_CL}	$V_{IN}=0V$, $I_O=1mA$, $V_{DD}=40V$	$V_{DD}-45$	–	–	V
High Level Input Voltage	V_{IH}	$I_O=10mA$	2.64	–	–	V
Low Level Input Voltage	V_{IL}	$I_O=100\mu A$	–	–	0.9	V
Protection Circuit Function Input Voltage Range	V_{IN_opr}		2.64	–	5.5	V
OUT Pin Leak Current at OFF State	$I_{OLEAKOUT}$	$V_{IN}=0V$, $V_{DD}=40V$	–	–	1	μA
Quiscent Current 1	I_{DD1}	$V_{IN}=0V$, $V_{DD}=40V$	–	–	1	μA
Quiscent Current 2	I_{DD2}	$V_{IN}=5V$	–	110	150	μA
Input Current	I_{IN}	$V_{IN}=5V$	–	150	190	μA
On-State Resistance	R_{DS_ON}	$V_{IN}=5V$, $I_O=0.2A$	–	0.75	1.2	Ω
Over Current Protection	I_{LIMIT}	$V_{IN}=5V$, $V_{DS}=5V$	0.2	0.4	0.8	A
Turn-on Time	t_{ON}	$V_{IN}=0$ to $5V$, $I_O=0.2A$	–	10	–	μs
Turn-off Time	t_{OFF}	$V_{IN}=5$ to $0V$, $I_O=0.2A$	–	10	–	μs
OUT–VDD Voltage Difference	V_{PDOV}	$V_{IN}=0V$, $I_{ORH}=0.2A$	–	0.85	1.2	V
FLT Pin Low Level Output Voltage	V_{VFLT}	$I_{FLT}=500\mu A$	–	0.25	0.5	V
FLT Pin Leak Current at OFF State	$I_{OLEAKFLT}$	$V_{FLT}=5.5V$	–	–	1	μA
FLT Delay Time	t_{DFLT}	$V_{IN}=0$ to $5V$	–	5	–	ms

NJW4832

■ TRUTH TABLE

[A-version: Active-high]

Input Signal	Operating Condition	FLT Pin	Output Status
L	Normal	H	OFF
H		L	ON
L	Over Current I_{LIMIT}	H	OFF
H		H	I_{LIMIT}
L	$T_j > 150^\circ\text{C}$	H	OFF
H		H	OFF

[B-version: Active-low]

Input Signal	Operating Condition	FLT Pin	Output Status
L	Normal	H	OFF
H		H	ON
L	Over Current I_{LIMIT}	H	OFF
H		L	I_{LIMIT}
L	$T_j > 150^\circ\text{C}$	H	OFF
H		L	OFF

■ TIMING CHART

ON, OFF Switching Time ($V_{IN}=0$ to $5V$, $V_{DD}=13V$, $I_O=0.2A$)

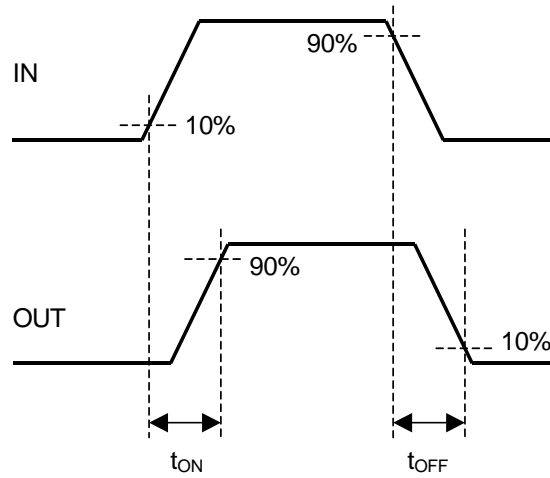

FLT Delay Time ($V_{IN}=0$ to $5V$, $V_{DD}=V_{DS}=13V$, FLT=Pull-up, OUT-GND shorting)

[A-version: Active-high]

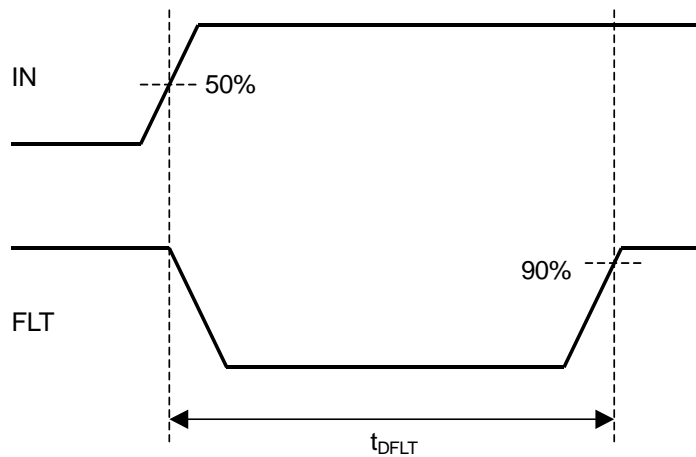

[B-version: Active-low]

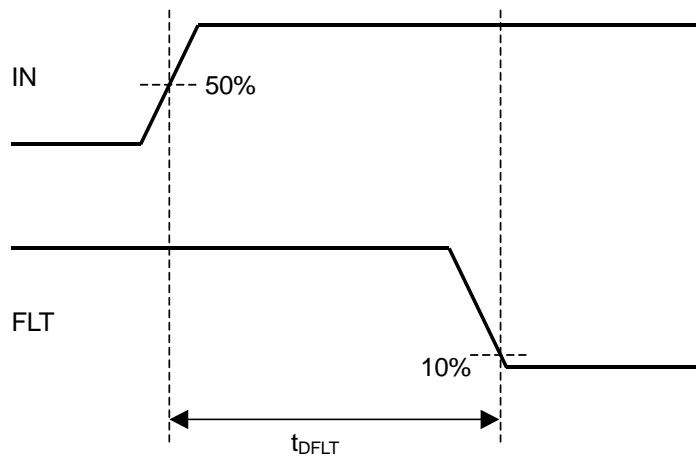

[A-version: Active-high]

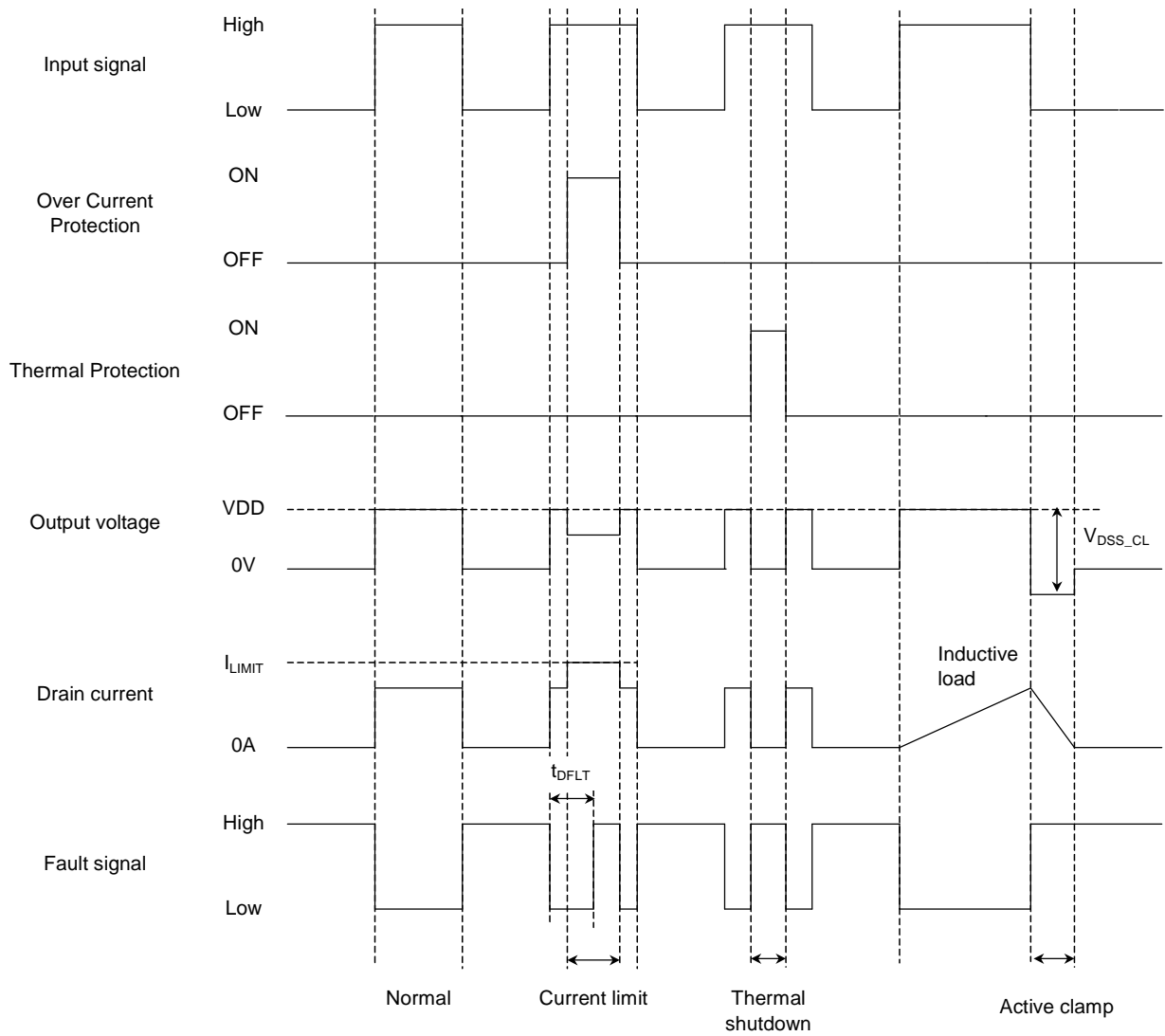

[B-version: Active-low]

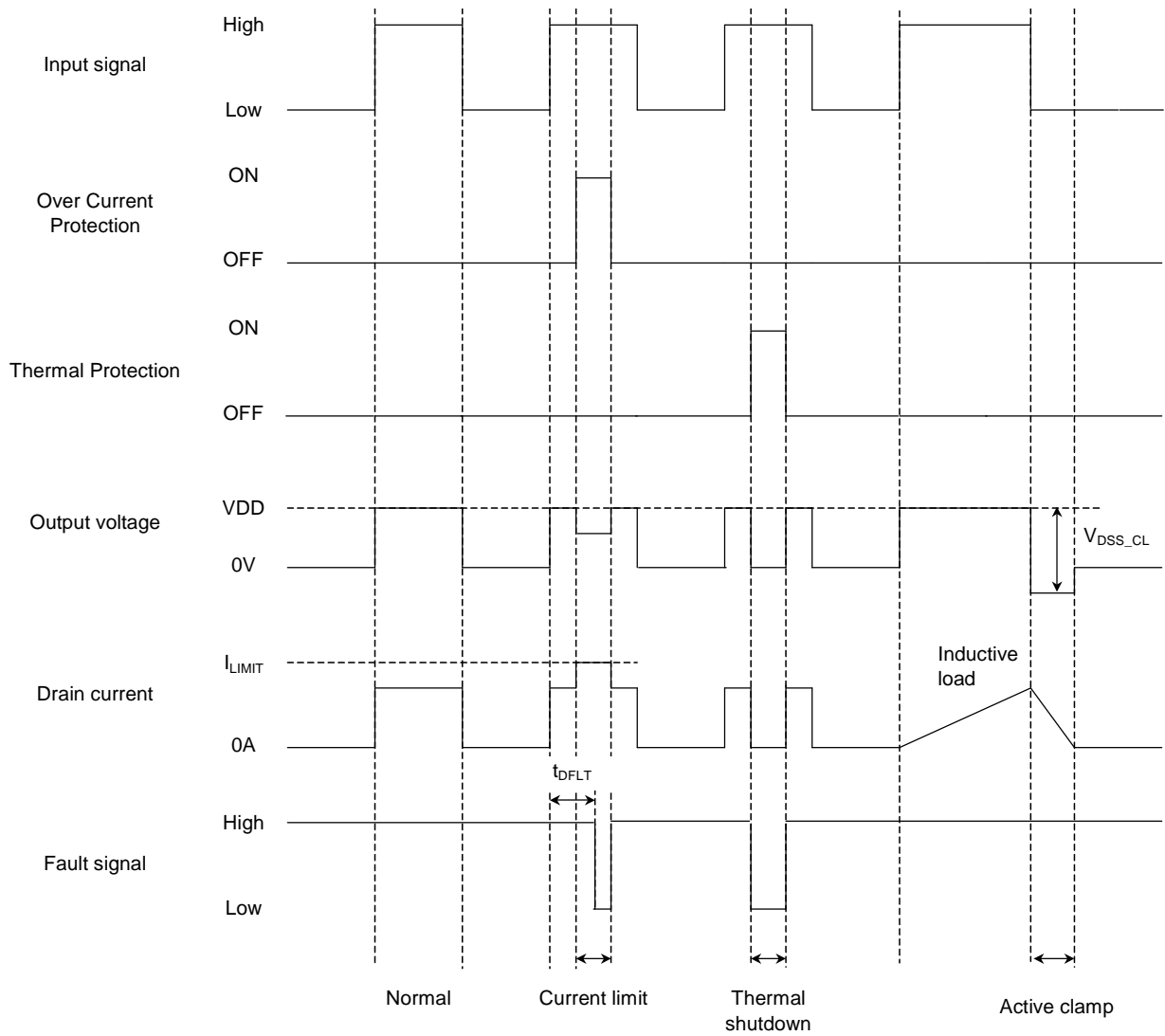

NJW4832

■ TYPICAL APPLICATION

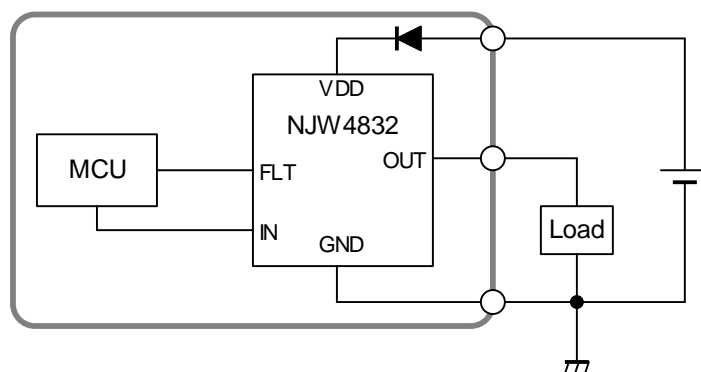

You should insert a pull-up resistor when you connect the FLT pin with other power supplies etc.

■ CHARACTERISTICS

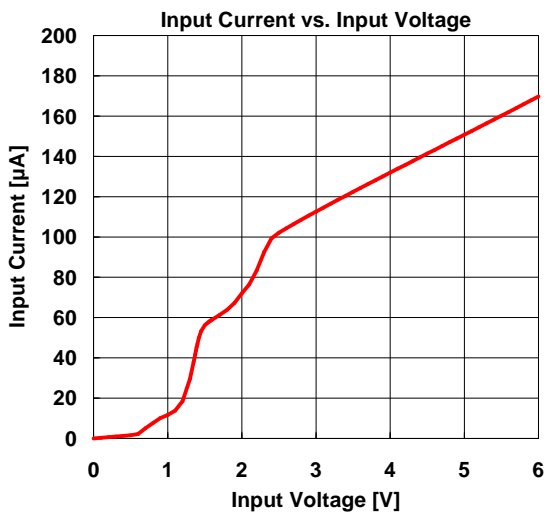
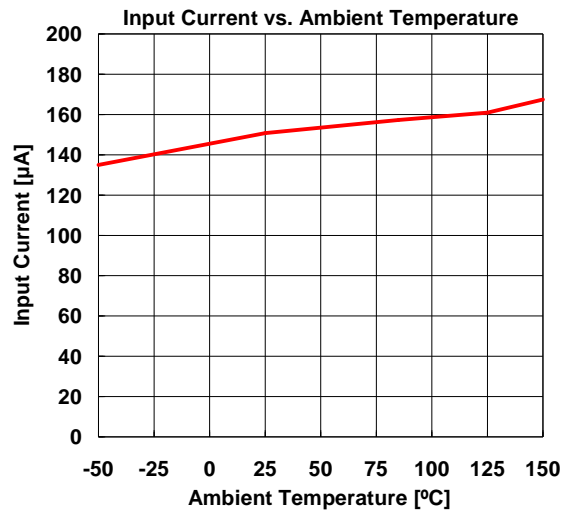
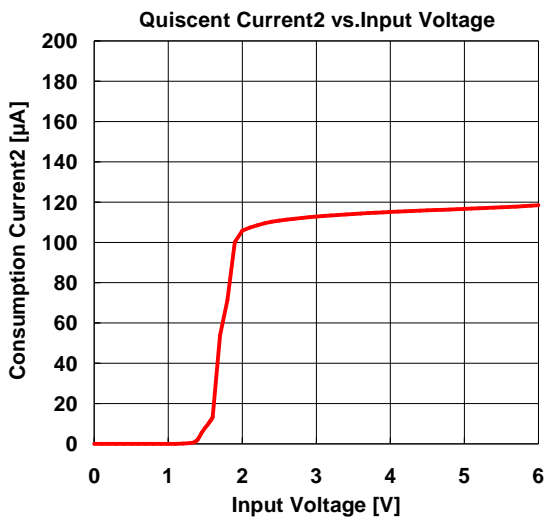
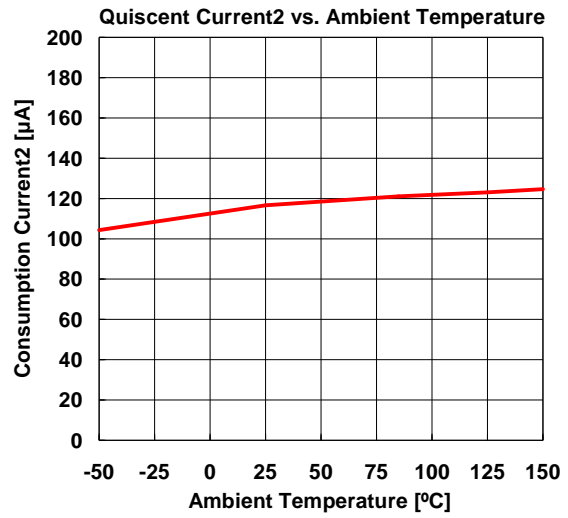
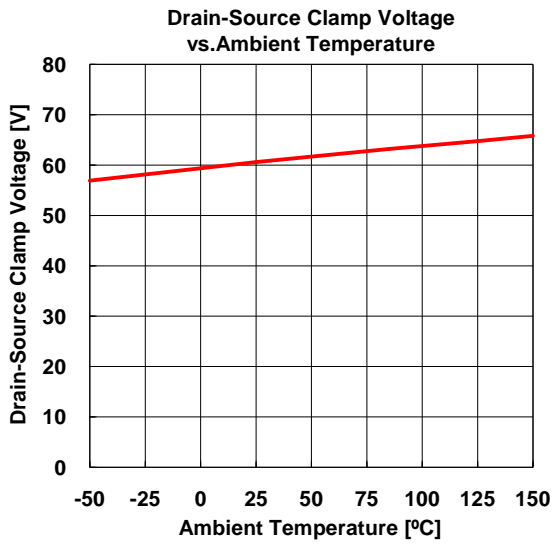

CHARACTERISTICS

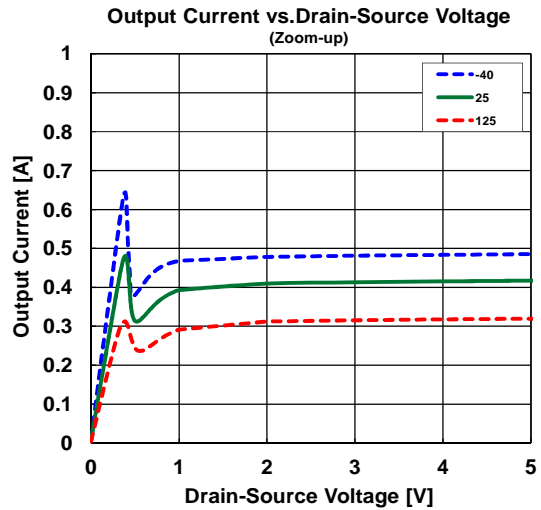
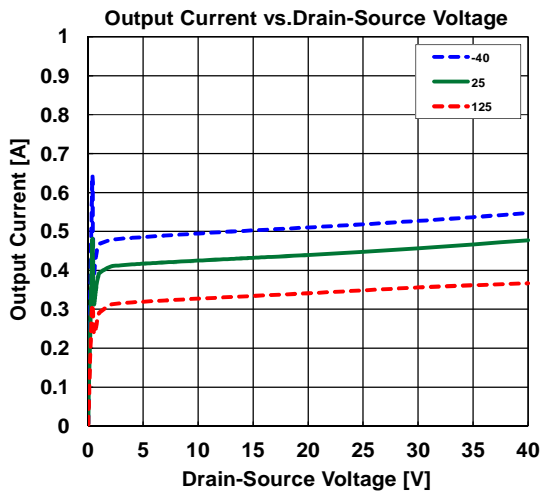
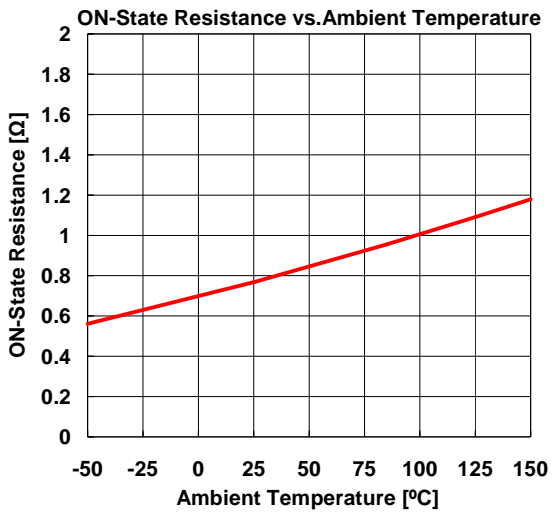
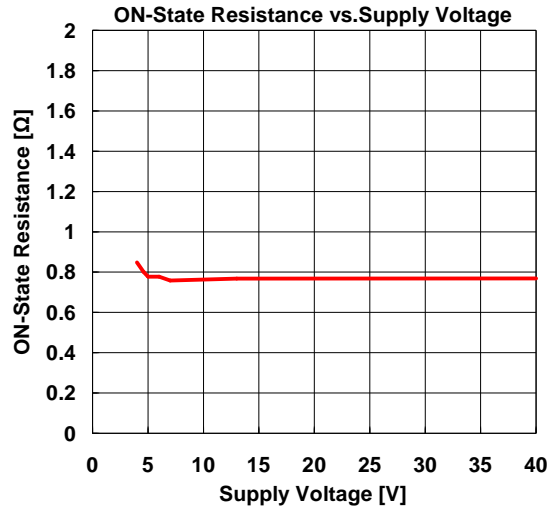
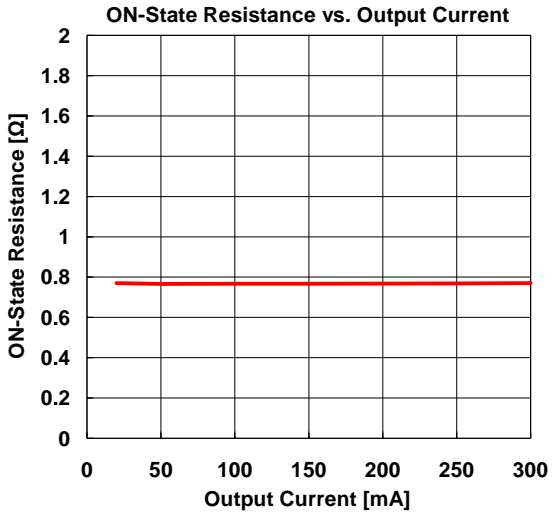

CHARACTERISTICS

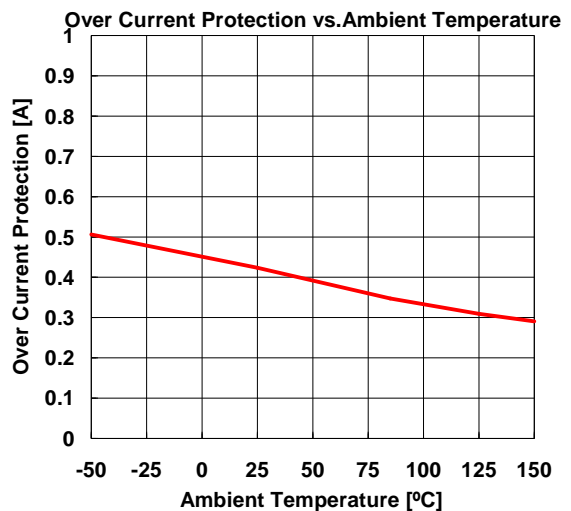
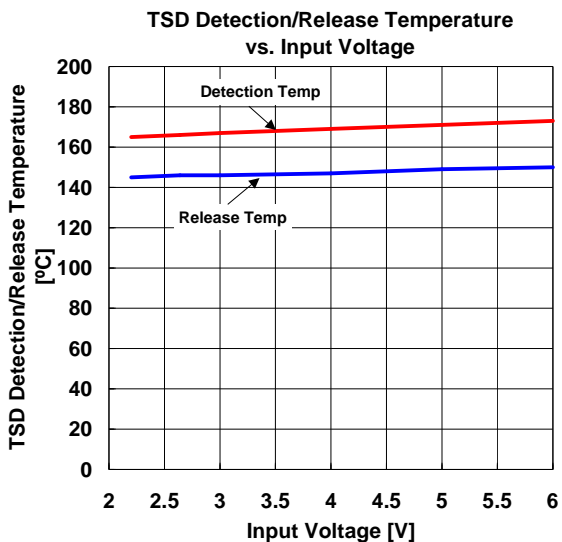
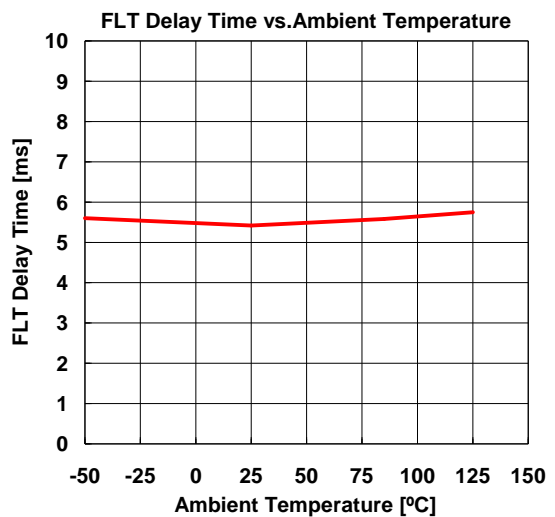
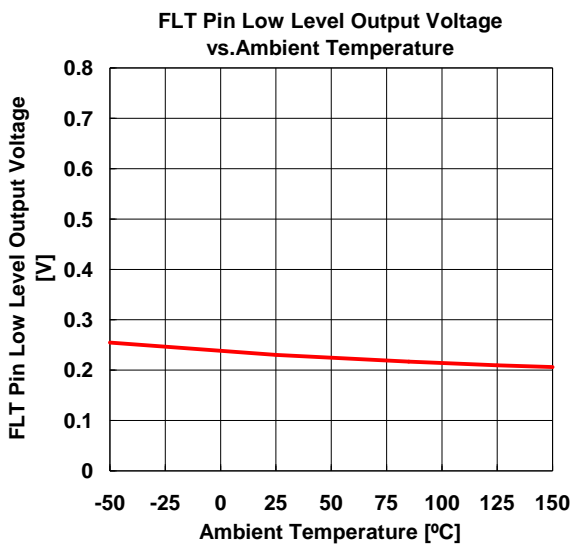
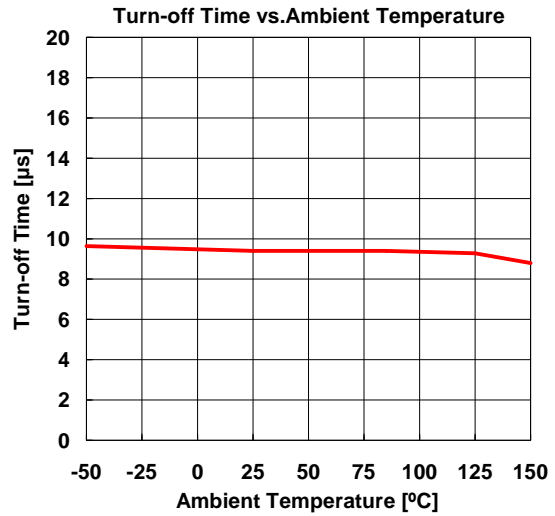
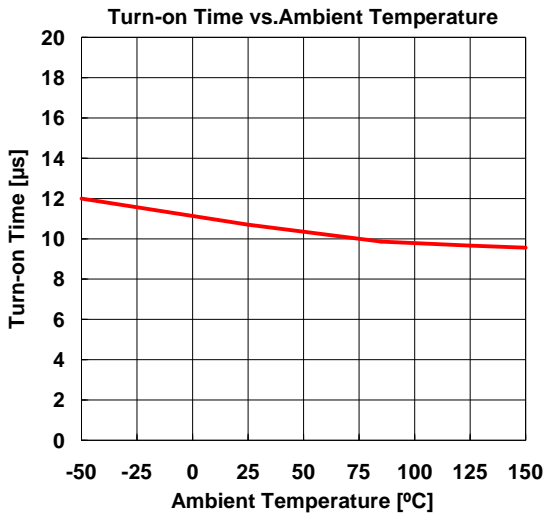

■ Regarding Active Clamp Capacity of High/Low side Switch Products

- What is “Active Clamp Capacity”.

The IC might suffer to damage by the inductive kickback at the transient time of ON state to OFF state, when an inductive load such as a solenoid or motor is used for the load of the high-side/low-side switch.

The protection circuit for the inductive kickback is the active clamp circuit. The energy that can be tolerated by the active clamp circuit is called "Active Clamp Capacity (E_{AS})".

When using an inductive load to the high-side/low-side switch, you should design so that the E_{SW} does not exceed the active clamp capability.

- IC operation without an external protection parts (Fig 1)

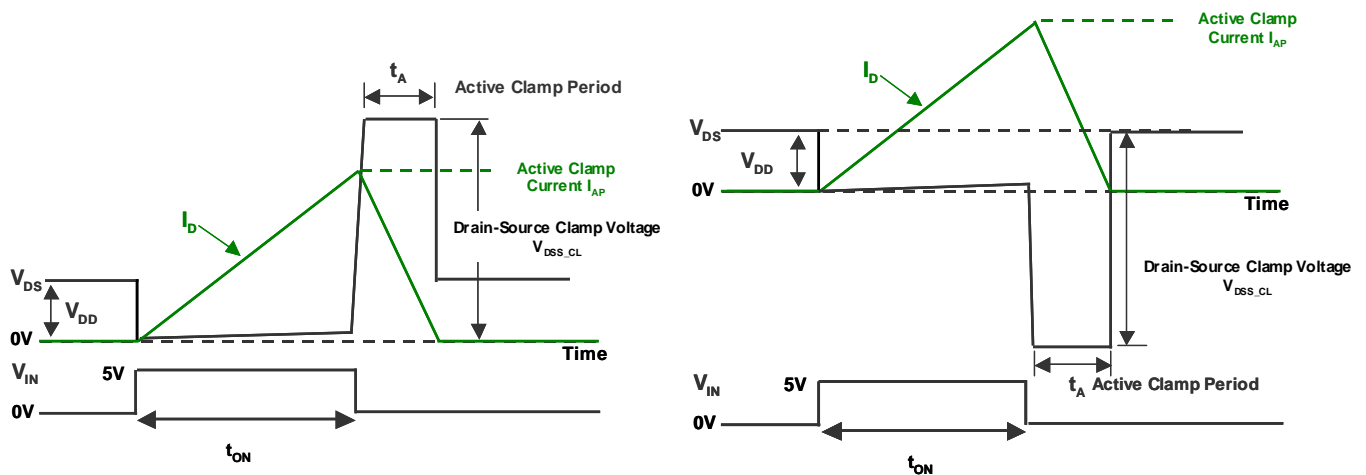

Fig1. Active Clamp Waveform (Left: Low-side Switch / Light High-side Switch)

At when the V_{IN} turns off, the drain-source voltage (V_{DS}) increases rapidly by the behavior of the inductive load that is keeping current flowing. However, it will be clamped at V_{DSS_CL} by the active clamp circuit. At the same time, the drain current is flowed by adjusting the gate voltage of the output transistor, and the energy is dissipated at the output transistor. The energy: E_{SW} is shown by the following formula.

$$E_{SW} = \int_0^{t_A} V_{DS}(t) \cdot I_D(t) dt = \frac{1}{2} L I_{AP}^2 \cdot \frac{V_{DSS_CL}}{V_{DSS_CL} - V_{DD}}$$

The E_{SW} is consumed inside IC as heat energy. However, the thermal shutdown does not work when the V_{IN} is 0V. Therefore in worst case the IC might break down. When using the active clamp, you should design E_{SW} does not exceed the E_{AS} .

- Application Hint

The simplest protection example is to add an external flywheel diode at the load to protect IC from an inductive kickback. (Fig.2)

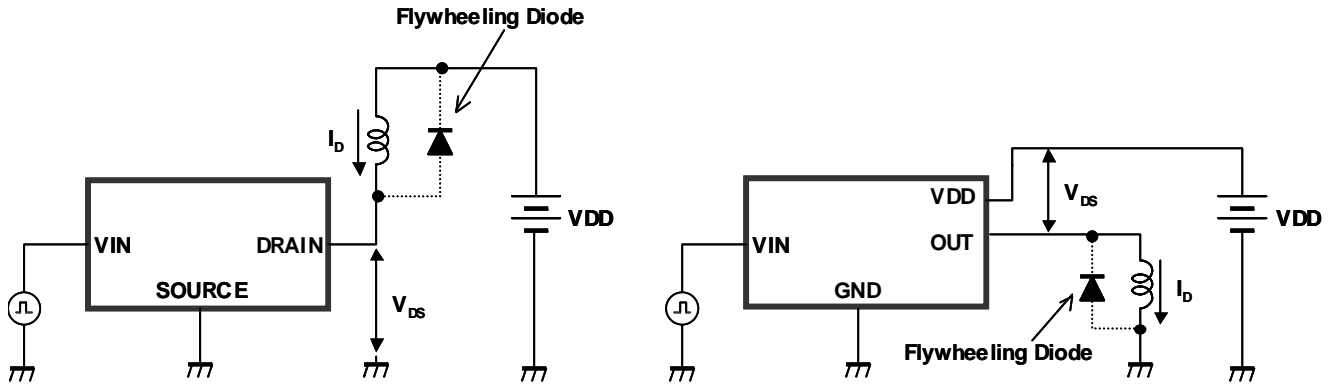

Fig 2. Application Circuit of Inductance Load Driving (Left: Low-side Switch / Light High-side Switch)

[CAUTION]

The specifications on this databook are only given for information, without any guarantee as regards either mistakes or omissions. The application circuits in this databook are described only to show representative usages of the product and not intended for the guarantee or permission of any right including the industrial rights.

NJW4832

■ PACKAGE OUT LINE

■ DFN6-H1 (ESON6-H1)

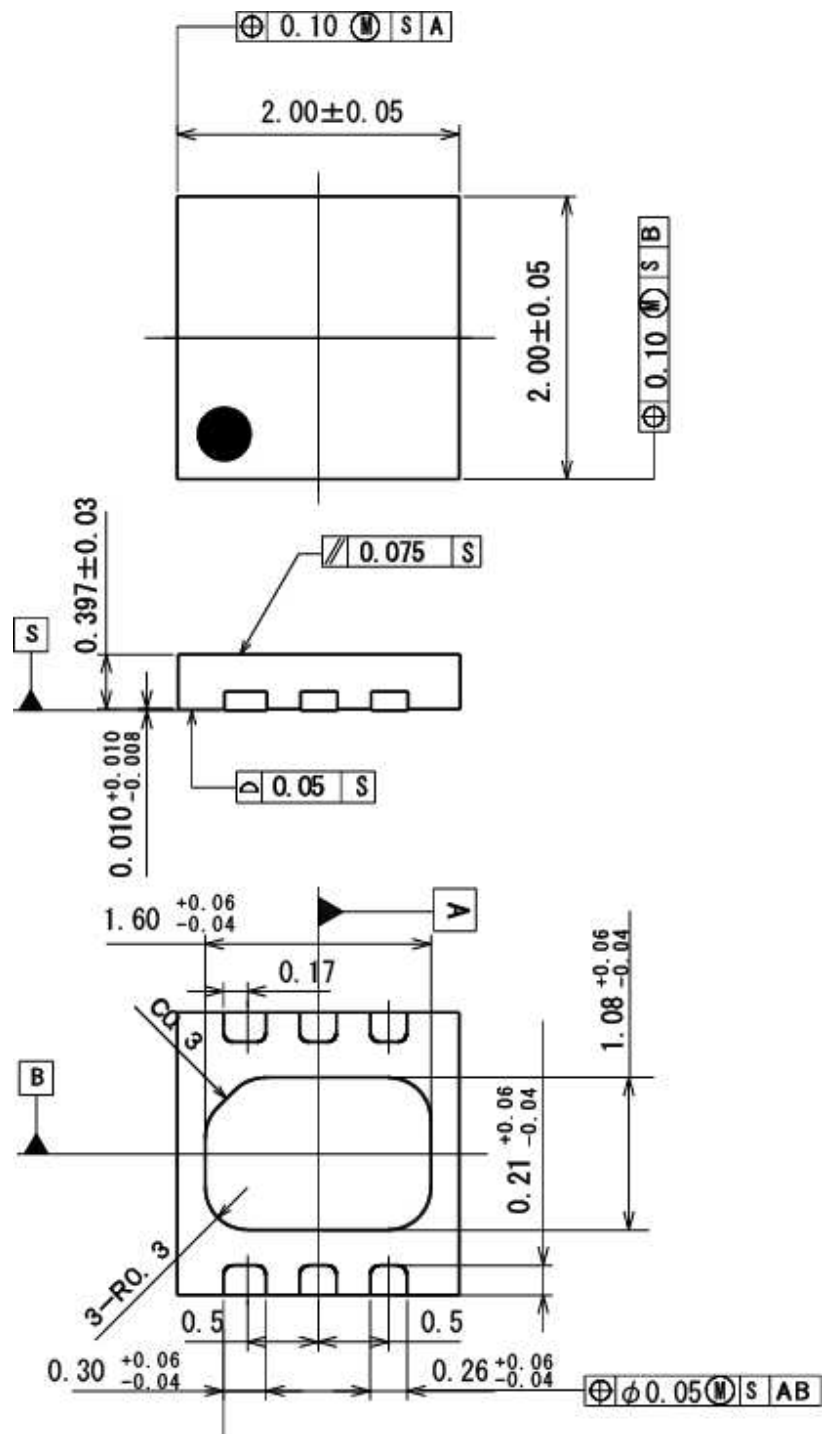

GD-N00602A-0
UNIT: mm

Mouser Electronics

Authorized Distributor

Click to View Pricing, Inventory, Delivery & Lifecycle Information:

[NJR:](#)

[NJW4832KH1-A-TE3](#) [NJW4832KH1-B-TE3](#)



Компания «ЭлектроПласт» предлагает заключение долгосрочных отношений при поставках импортных электронных компонентов на взаимовыгодных условиях!

Наши преимущества:

- Оперативные поставки широкого спектра электронных компонентов отечественного и импортного производства напрямую от производителей и с крупнейших мировых складов;
- Поставка более 17-ти миллионов наименований электронных компонентов;
- Поставка сложных, дефицитных, либо снятых с производства позиций;
- Оперативные сроки поставки под заказ (от 5 рабочих дней);
- Экспресс доставка в любую точку России;
- Техническая поддержка проекта, помощь в подборе аналогов, поставка прототипов;
- Система менеджмента качества сертифицирована по Международному стандарту ISO 9001;
- Лицензия ФСБ на осуществление работ с использованием сведений, составляющих государственную тайну;
- Поставка специализированных компонентов (Xilinx, Altera, Analog Devices, Intersil, Interpoint, Microsemi, Aeroflex, Peregrine, Syfer, Eurofarad, Texas Instrument, Miteq, Cobham, E2V, MA-COM, Hittite, Mini-Circuits, General Dynamics и др.);

Помимо этого, одним из направлений компании «ЭлектроПласт» является направление «Источники питания». Мы предлагаем Вам помощь Конструкторского отдела:

- Подбор оптимального решения, техническое обоснование при выборе компонента;
- Подбор аналогов;
- Консультации по применению компонента;
- Поставка образцов и прототипов;
- Техническая поддержка проекта;
- Защита от снятия компонента с производства.



Как с нами связаться

Телефон: 8 (812) 309 58 32 (многоканальный)

Факс: 8 (812) 320-02-42

Электронная почта: org@eplast1.ru

Адрес: 198099, г. Санкт-Петербург, ул. Калинина, дом 2, корпус 4, литера А.