

RJ45 10/100/1000 Base-TX Tab down 1x2 Jack with Magnetic Module

ARJ12A

RoHS
Compliant

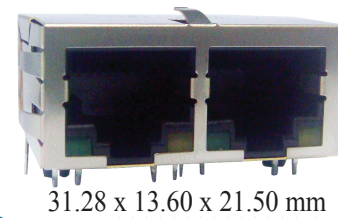

31.28 x 13.60 x 21.50 mm

FEATURES:

- Tab down
- Available with or without LED
- Suitable CAT 5 & 6 cable and UTP
- Comply IEEE 802.3ab
- LAN Magnetic with RJ4
- Suitable for RoHS compliant reflow

APPLICATIONS:

- 10, 100 and 1000 Base-T LAN
- NIC, LoM and PC

STANDARD SPECIFICATIONS at 25°C

Operating temperature range: 0°C to +70°C Storage temperature range: -40°C to +85°C

Part Number	Turns Ratio $\pm 5\%$		Tab	EMI Fingers	LEDs	Insertion Loss (dB typ)	Return Loss (dB typ @100 Ω $\pm 15\%$)		
	TX	RX					0.3- 100 MHz	1- 10 MHz	30 MHz
ARJ12A-MASD-A-B-EMU2	1CT:1CT	1CT:1CT	DOWN	Yes	G/Y	-1.2	-18	-16	-12
ARJ12A-MASD-A-B-FMU2	1CT:1CT	1CT:1CT	DOWN	Yes	G/Y	-1.2	-18	-16	-12
ARJ12A-MCSD-MU2	1CT:1CT	1CT:1CT	DOWN	Yes	-	-1.2	-18	-16	-12

Part Number	Crosstalk (dB TYP)			Common Mode Rejection (dB TYP)		Hipot (Vrms)
	1 - 10 MHz	30 - 60 MHz	60 - 100 MHz	1 - 50 MHz	50 - 130 MHz	
ARJ12A-MASD-A-B-EMU2	-40	-35	-30	-30	-20	1500
ARJ12A-MASD-A-B-FMU2	-40	-35	-30	-30	-20	1500
ARJ12A-MCSD-MU2	-40	-35	-30	-30	-20	1500

Contact Abracon for more custom configurations. See options to build a custom configuration.

OPTIONS AND PART IDENTIFICATION

ARJ12A - - - -

Mechanical	Schematic	Left LED color (e.g. B for Yellow, AB for Green-Yellow)	Right LED color (e.g. B for Yellow, AB for Green-Yellow)	LED polarity	Turns Ratio (Tx)	Turns Ratio (Rx)	Gold plating
MA ~ MD (Please see mechanical section)	SA ~ SZ (Please see schematic section)	Blank: No LED A: Green B: Yellow C: Amber D: Orange	Blank: No LED A: Green B: Yellow C: Amber D: Orange	Blank: No LED E ~ H (Please see 7.0 LED polarity section)	K: 1CT:1.41 L: 1CT:1 M: 1CT:1CT N: 1.414:1CT O: 1CT:1.41CT P: 1:2CT Q: 1:1.414CT R: 1CT:2.5	S: 1CT:1.41 T: 1CT:1 U: 1CT:1CT V: 1.414:1CT W: 1CT:1.41CT X: 1:2CT Y: 1:1.414CT Z: 1CT:2.5	1: 3u “ 2: 6u “ 3: 15u “ 4: 30u “ 5: 50u “

RJ45 10/100/1000 Base-TX Tab down 1x2 Jack with Magnetic Module

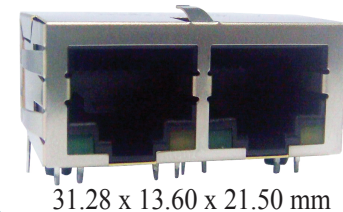

31.28 x 13.60 x 21.50 mm

ARJ12A

RoHS
Compliant

MECHANICAL DIMENSIONS

MA (10/100 Base-T)

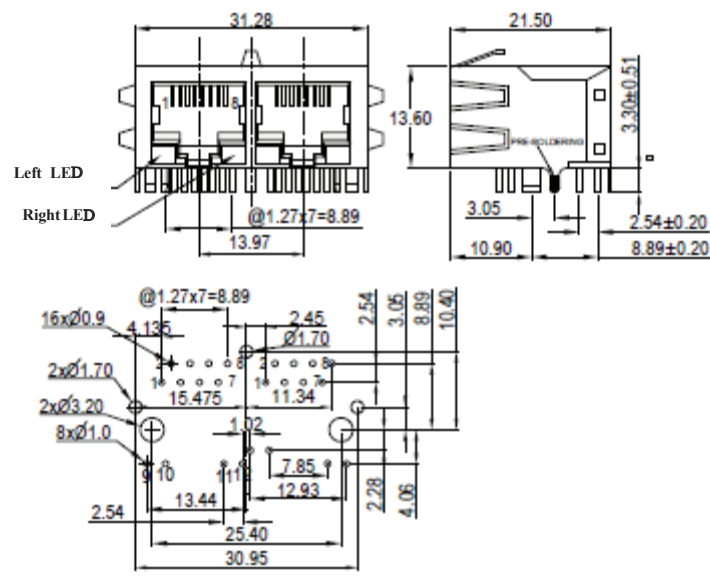

MB (1000 Base-T)

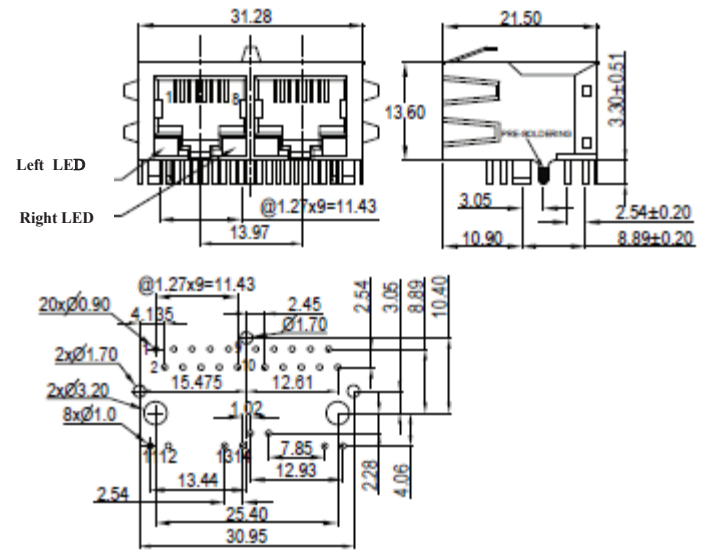

MC (10/100 Base-T)

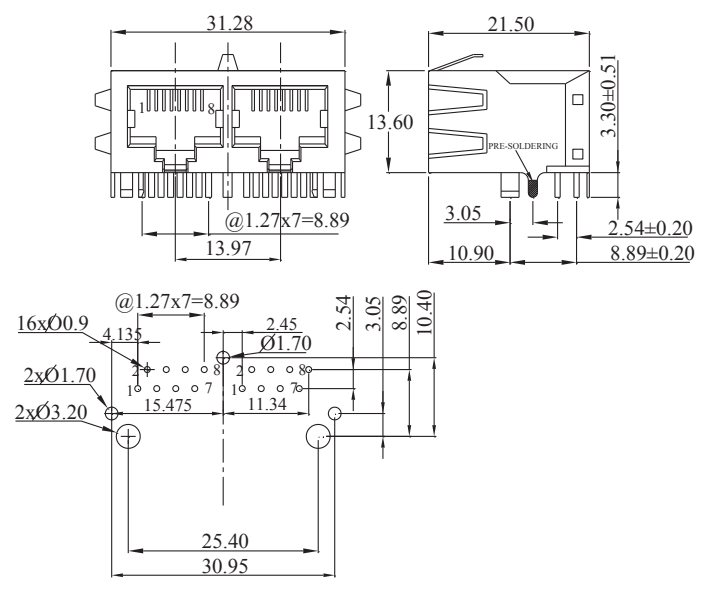

MD (1000 Base-T)

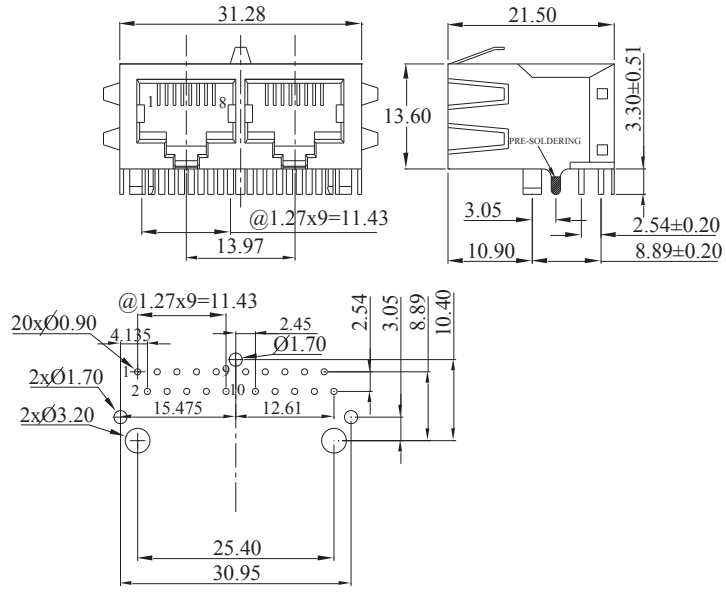

Dimension: mm. All tolerances are ±0.25 unless otherwise specified



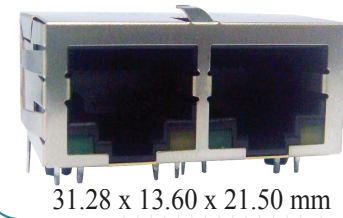

31.28 x 13.60 x 21.50 mm

ARJ12A

RoHS
Compliant

SCHEMATICS

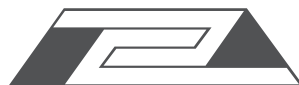
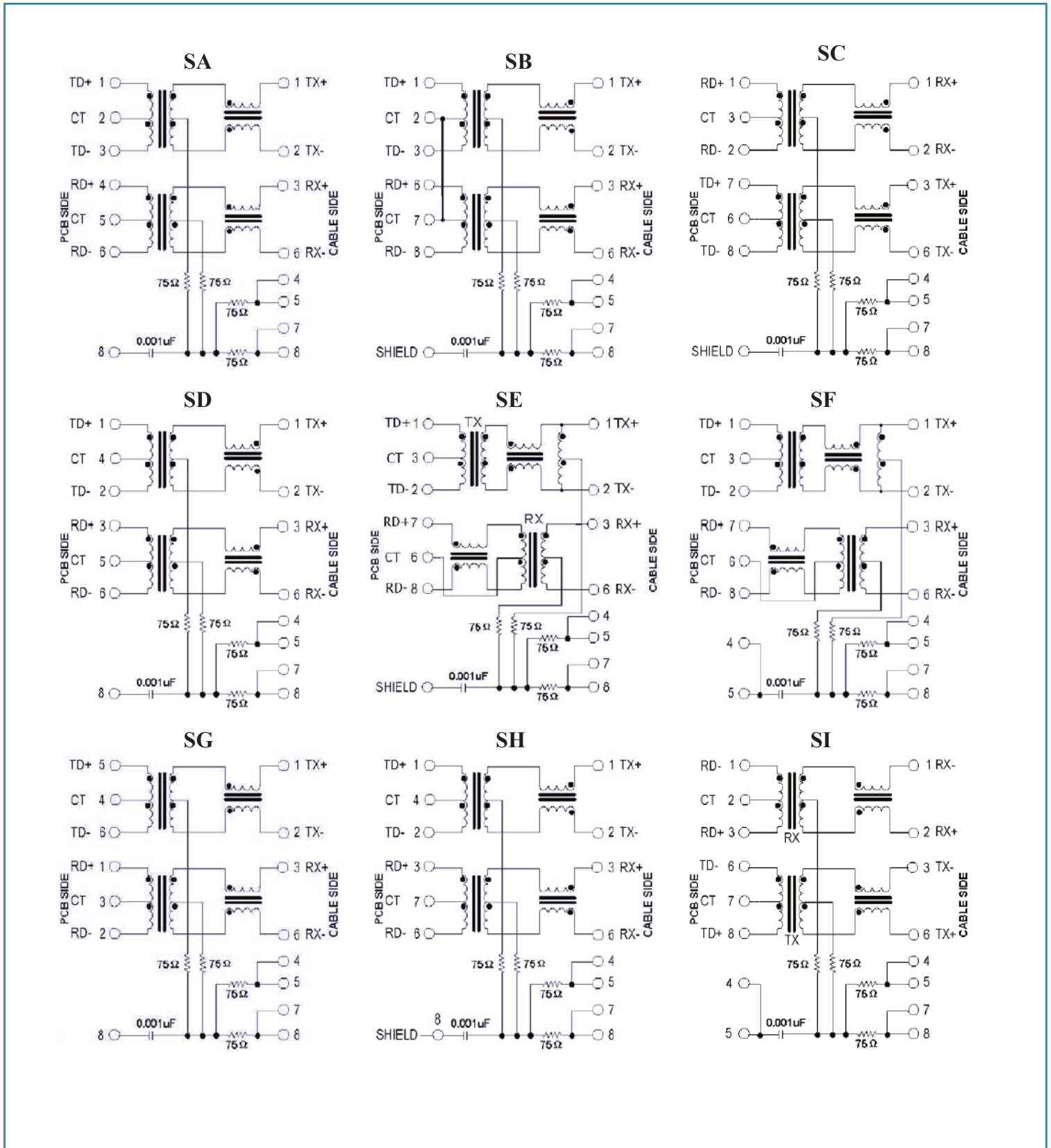

RJ45 10/100/1000 Base-TX Tab down 1x2 Jack with Magnetic Module

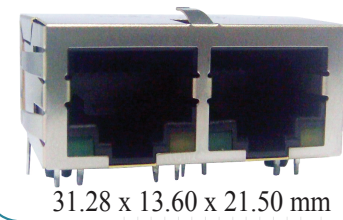

ARJ12A

RoHS
Compliant

SCHEMATICS - continued

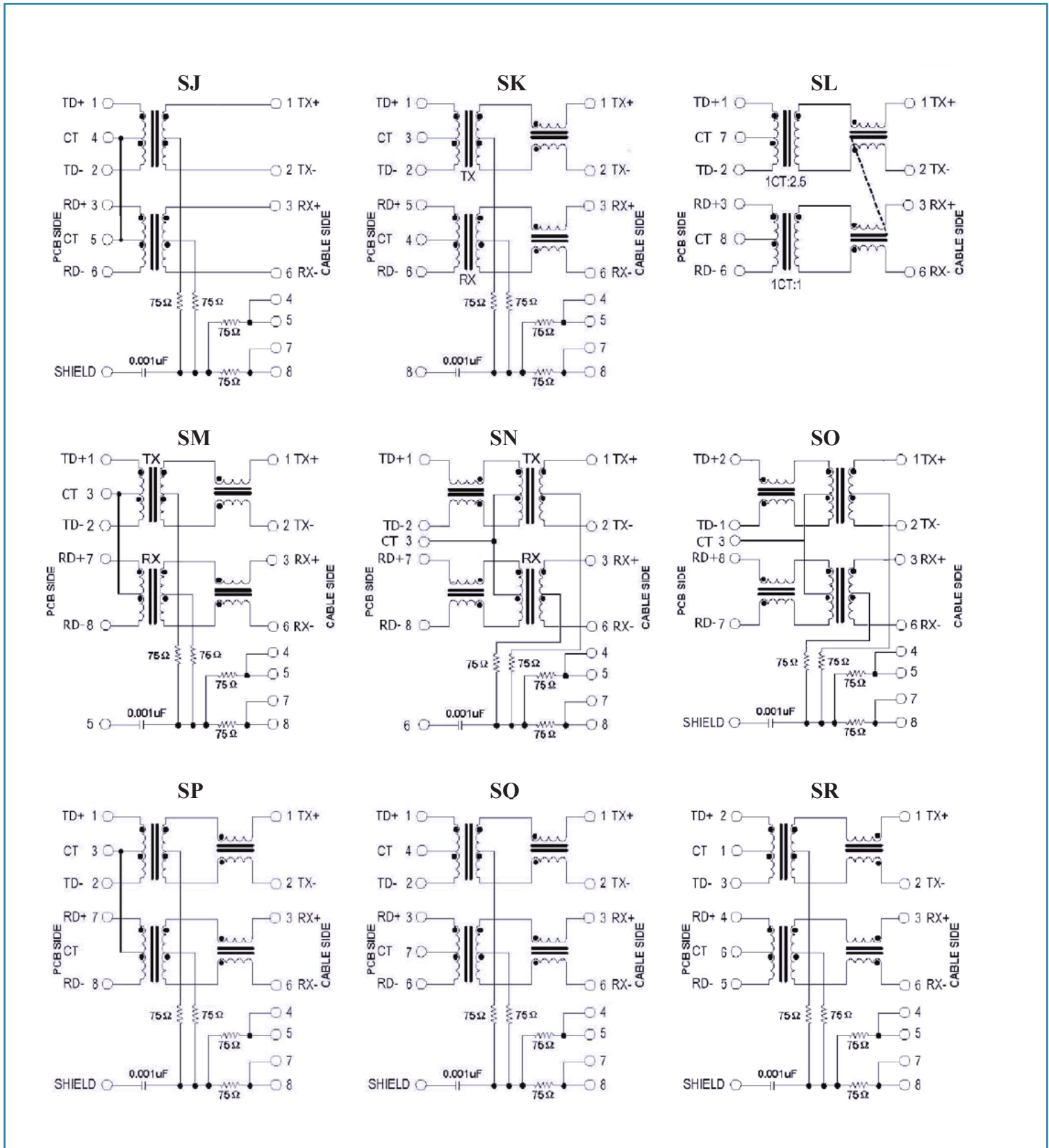

ABRACON IS
ISO 9001:2008
CERTIFIED

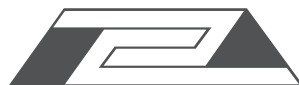

ABRACON
CORPORATION

Visit www.abracon.com for Terms & Conditions of Sale
30332 Esperanza, Rancho Santa Margarita, California 92688
tel 949-546-8000 | fax 949-546-8001 | www.abracon.com

Revised: 08.02.11

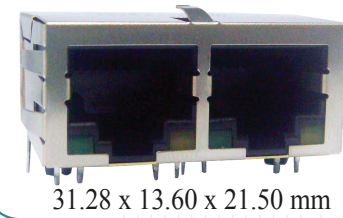

31.28 x 13.60 x 21.50 mm

ARJ12A

RoHS
Compliant

SCHEMATICS

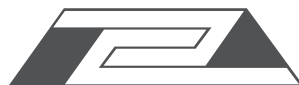
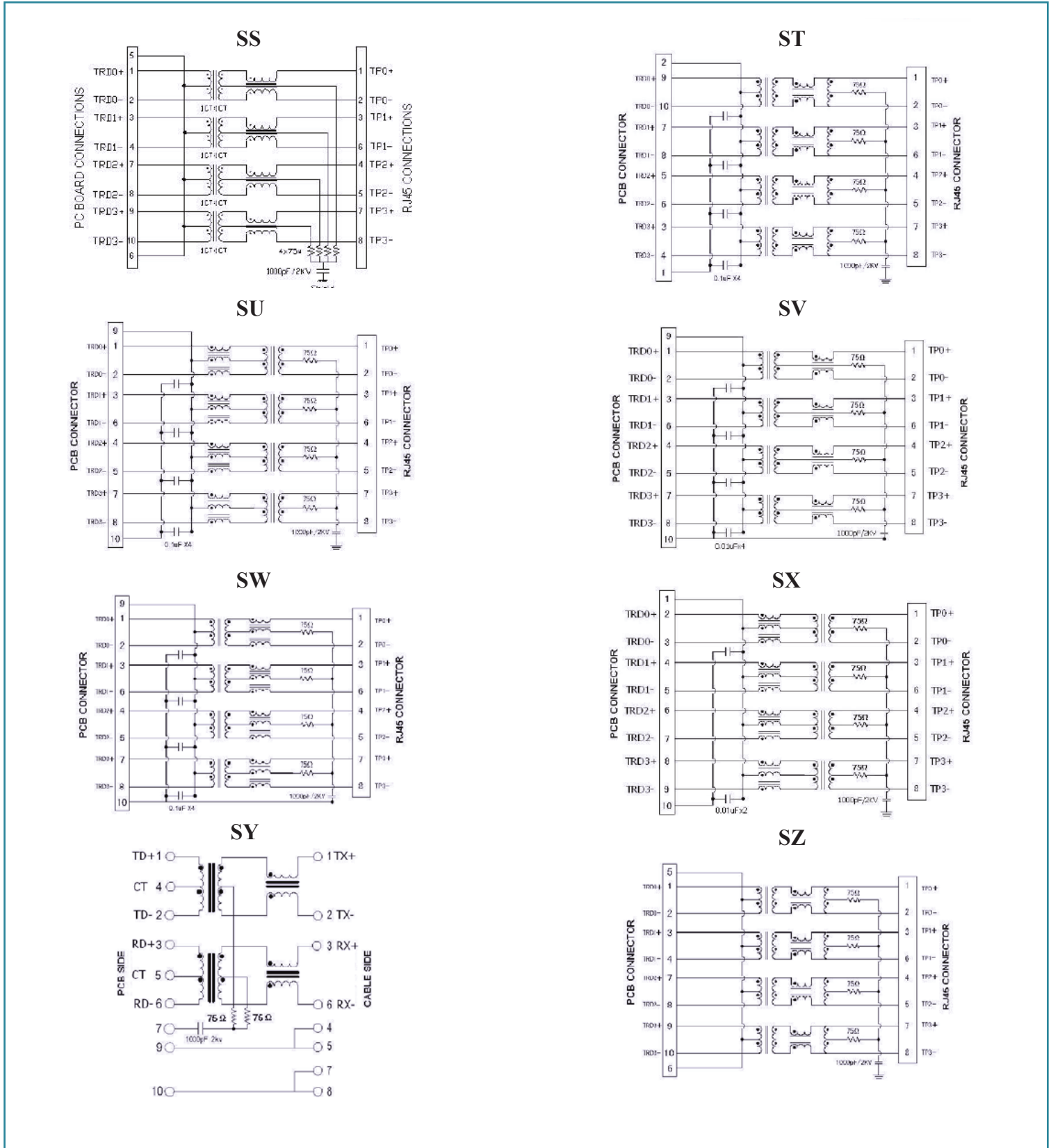

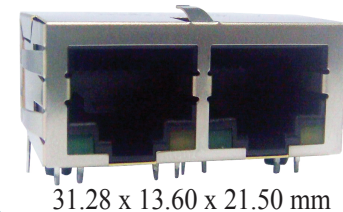

ARJ12A

RoHS
Compliant

LED POLARITY

8PIN:

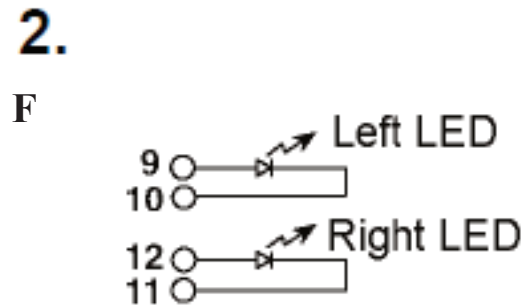
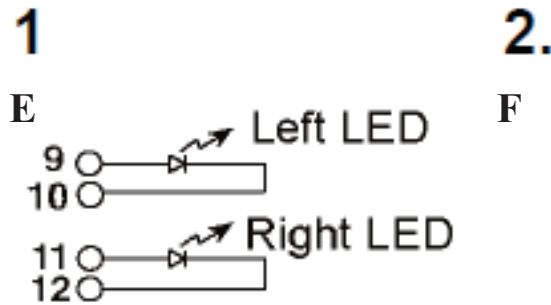

10PIN:

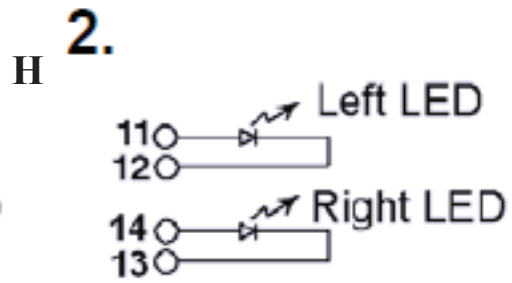
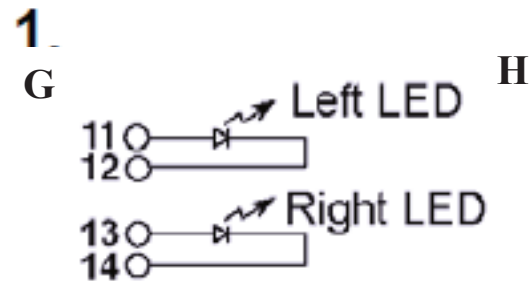

RJ45 10/100/1000 Base-TX Tab down 1x2 Jack with Magnetic Module

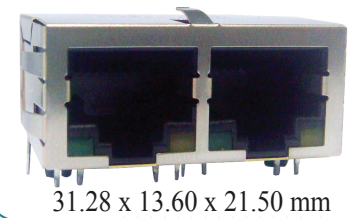

ARJ12A

RoHS
Compliant

PACKING: 30pcs/tray

Packaging material: PET

Outer carton unit : 600 pcs/ 20 Trays/box

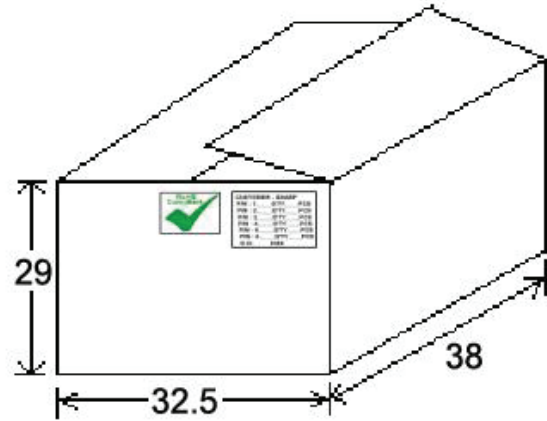
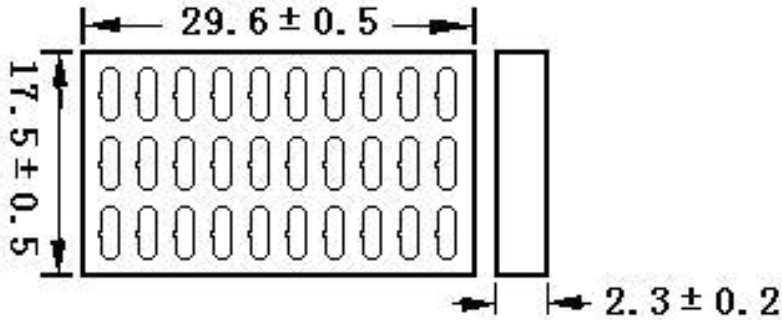

REFLOW PROFILE:

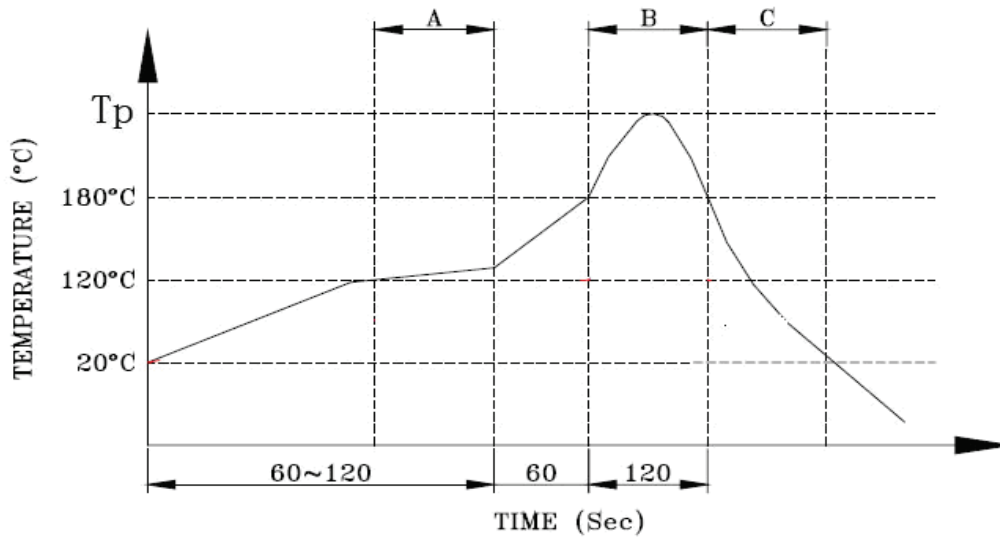

A. Preheating B. Soldering C. Gradual Cooling

Peak temperature(Tp) : 250± 10°C

Peak temperature(Tp) time : 5sec max

ATTENTION: Abracon Corporation's products are COTS – Commercial-Off-The-Shelf products; suitable for Commercial, Industrial and, where designated, Automotive Applications. Abracon's products are not specifically designed for Military, Aviation, Aerospace, Life-dependant Medical applications or any application requiring high reliability where component failure could result in loss of life and/or property. For applications requiring high reliability and/or presenting an extreme operating environment, written consent and authorization from Abracon Corporation is required. Please contact Abracon Corporation for more information.

ABRACON IS
ISO 9001:2008
CERTIFIED



ABRACON
CORPORATION

Visit www.abracon.com for Terms & Conditions of Sale
30332 Esperanza, Rancho Santa Margarita, California 92688
tel 949-546-8000 | fax 949-546-8001 | www.abracon.com

Revised: 08.02.11



Компания «ЭлектроПласт» предлагает заключение долгосрочных отношений при поставках импортных электронных компонентов на взаимовыгодных условиях!

Наши преимущества:

- Оперативные поставки широкого спектра электронных компонентов отечественного и импортного производства напрямую от производителей и с крупнейших мировых складов;
- Поставка более 17-ти миллионов наименований электронных компонентов;
- Поставка сложных, дефицитных, либо снятых с производства позиций;
- Оперативные сроки поставки под заказ (от 5 рабочих дней);
- Экспресс доставка в любую точку России;
- Техническая поддержка проекта, помощь в подборе аналогов, поставка прототипов;
- Система менеджмента качества сертифицирована по Международному стандарту ISO 9001;
- Лицензия ФСБ на осуществление работ с использованием сведений, составляющих государственную тайну;
- Поставка специализированных компонентов (Xilinx, Altera, Analog Devices, Intersil, Interpoint, Microsemi, Aeroflex, Peregrine, Syfer, Eurofarad, Texas Instrument, Miteq, Cobham, E2V, MA-COM, Hittite, Mini-Circuits, General Dynamics и др.);

Помимо этого, одним из направлений компании «ЭлектроПласт» является направление «Источники питания». Мы предлагаем Вам помощь Конструкторского отдела:

- Подбор оптимального решения, техническое обоснование при выборе компонента;
- Подбор аналогов;
- Консультации по применению компонента;
- Поставка образцов и прототипов;
- Техническая поддержка проекта;
- Защита от снятия компонента с производства.



Как с нами связаться

Телефон: 8 (812) 309 58 32 (многоканальный)

Факс: 8 (812) 320-02-42

Электронная почта: org@eplast1.ru

Адрес: 198099, г. Санкт-Петербург, ул. Калинина, дом 2, корпус 4, литера А.