

Description

Single pole high performance thermal circuit breaker with tease-free, trip-free, snap action mechanism and push/pull on/off manual actuation (M-type TO CBE to EN 60934). An indicator band on the push button clearly shows the tripped/off position. Threadneck panel mounted and available in tracked vehicle, aircraft and general purpose versions.

Typical applications

Extra low voltage wiring systems on all types of vehicles for land, sea and air; defence equipment; battery powered machines.

Ordering information

Type No.	413	threadneck panel mounting
		Terminal design
	K14	screw terminals M6 (to aircraft specs.)
	K54	as K34, but housing sealed
		Version
	FN2	vehicle application, nickel-plated
	LN2	aircraft application, black finish
	N2	general application, nickel-plated
		Current ratings
		30...55 A (-FN2)
		30...90 A (-LN2/N2)
413 - K14 - LN2 - 40 A ordering example		

Preferred types

NEW

Preferred types	Standard current ratings (A)								
	30	35	40	45	50	60	70	80	90
413-K54-FN2-	x	x	x	x	x				
413-K14-LN2-	x	x	x	x	x	x	x	x	x

Standard current ratings and typical voltage drop values

Current rating (A)	Voltage drop (mV)		Current rating (A)	Voltage drop (mV)	
	-LN/N	-FN		-LN/N	-FN
30	≤ 250	≤ 250	55	-	≤ 200
35	≤ 250	≤ 250	60	≤ 200	-
40	≤ 200	≤ 200	70	≤ 200	-
45	≤ 200	≤ 200	80	≤ 200	-
50	≤ 200	≤ 200	90	≤ 200	-
13	≤ 200	≤ 200			

Approvals

Test authority	Voltage ratings	Current ratings
UL	DC 28 V	30...90 A
QPL Sweden	DC 28 V	30...50 A



413-...

Technical data

Voltage rating	DC 28 V AC 115 V (400 Hz) upon request	
Current rating range	30...55 A (-FN2) 30...90 A (-LN2/-N2),	
Typical life	2,000 operations at 1 x I _N	
Ambient temperature	-55...+75 °C (-67...+167 °F)	
Insulation co-ordination (IEC 60664 and 60664A)	rated impulse withstand voltage 1.5 kV	pollution degree 3
Dielectric strength (IEC 60664 and 60664A) operating area	test voltage AC 1,500 V	
Insulation resistance	> 100 MΩ (DC 500 V)	
Interrupting capacity I _{cn}	6,000 A	
Interrupting capacity (UL 1077)	6,000 A	
Degree of protection (IEC 60529/DIN 40050)	operating area IP40 terminal area IP00	
Vibration	10 g (56-500 Hz), ± 0.76 mm (10-55 Hz) to VG 95210, sheet 19, MIL-STD-202, meth. 204, IEC 60068-2-6, test Fc	
Shock	50 g (11 ms) to VG 95210, sheet 28, MIL-STD-202, meth. 213, IEC 60068-2-27, test Ea	
Corrosion	96 hours at 5 % salt mist, to VG 95210, sheet 2, MIL-STD-202, meth. 101, IEC 60068-2-11, test Ka	
Humidity	240 hours at 95 % RH to VG 95210, sheet 7, MIL-STD-202, meth. 106, IEC 60068-2-3, test Ca	
Mass	approx. 65 g	

Dimensions

413-K14-...

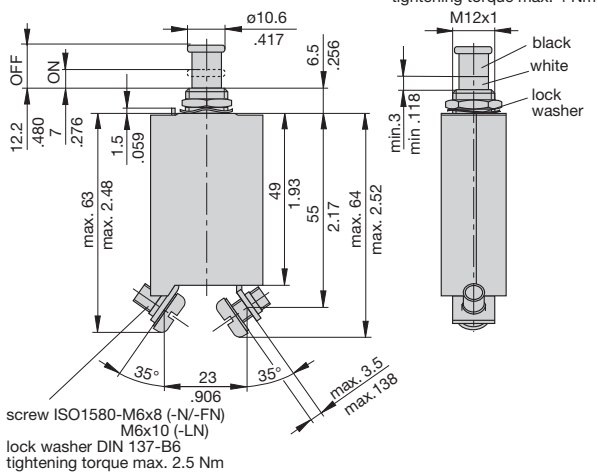

413-K14-LN2

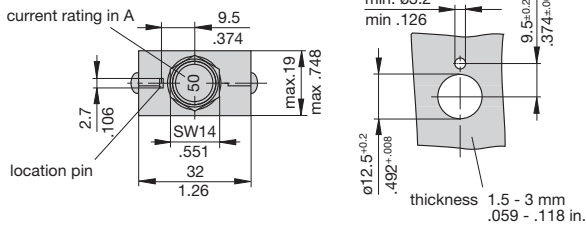

413-K54-...

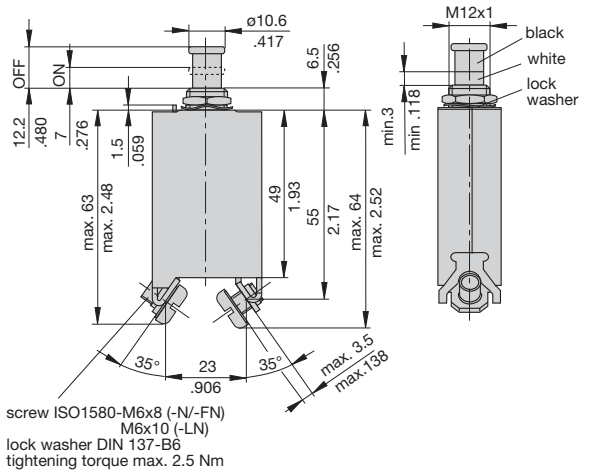

413-K54-FN2/-N2

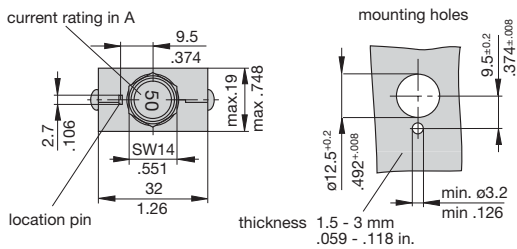

Internal connection diagram

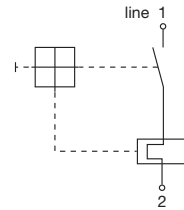

Typical time/current characteristics

413-...-FN2 30...55 A

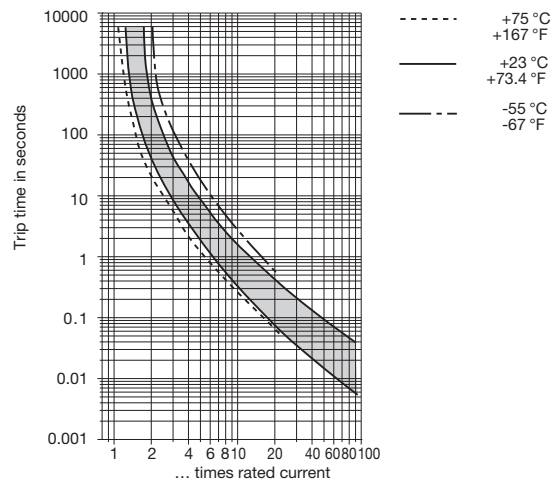

413-...-LN2/-N2 30...90 A

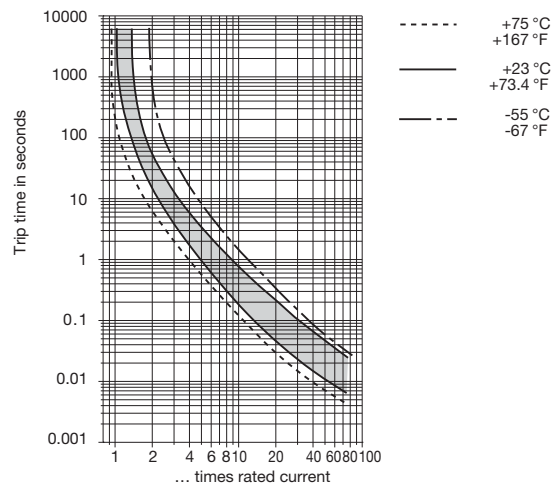

This is a metric design and millimeter dimensions take precedence ($\frac{\text{mm}}{\text{inch}}$)

Accessories (approved to VG 95345, part 23)

Splash cover /hex nut assembly with O ring (IP66 and IP67)
X 200 801 08 nickel plated nut M12x1, transparent cover
X 200 801 03 matt black finish nut M12x1, black cover

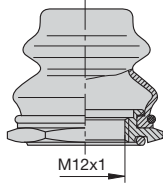

Splash cover black /hex nut assembly with O ring (IP54)
X 200 802 01 nickel plated nut M12x1
X 200 802 02 matt black finish nut M12x1

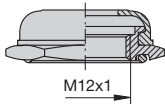

Actuator extension (black)
 to be fitted on the push button
X 200 803 01

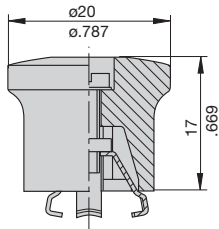

Accessories

Identification collar to be snapped on the push button

- Y 307 004 01** black
- Y 307 004 02** white
- Y 307 004 03** red
- Y 307 004 04** green
- Y 307 004 05** blue

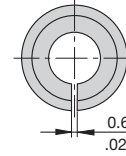
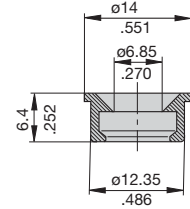

Lock out ring to block the push button in OFF position

- Y 307 005 01** red
- Y 307 005 02** black

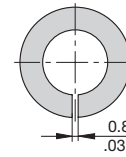
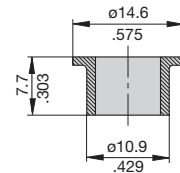

This is a metric design and millimeter dimensions take precedence ($\frac{\text{mm}}{\text{inch}}$)

All dimensions without tolerances are for reference only. In the interest of improved design, performance and cost effectiveness the right to make changes in these specifications without notice is reserved. Product markings may not be exactly as the ordering codes. Errors and omissions excepted.



Компания «ЭлектроПласт» предлагает заключение долгосрочных отношений при поставках импортных электронных компонентов на взаимовыгодных условиях!

Наши преимущества:

- Оперативные поставки широкого спектра электронных компонентов отечественного и импортного производства напрямую от производителей и с крупнейших мировых складов;
- Поставка более 17-ти миллионов наименований электронных компонентов;
- Поставка сложных, дефицитных, либо снятых с производства позиций;
- Оперативные сроки поставки под заказ (от 5 рабочих дней);
- Экспресс доставка в любую точку России;
- Техническая поддержка проекта, помощь в подборе аналогов, поставка прототипов;
- Система менеджмента качества сертифицирована по Международному стандарту ISO 9001;
- Лицензия ФСБ на осуществление работ с использованием сведений, составляющих государственную тайну;
- Поставка специализированных компонентов (Xilinx, Altera, Analog Devices, Intersil, Interpoint, Microsemi, Aeroflex, Peregrine, Syfer, Eurofarad, Texas Instrument, Miteq, Cobham, E2V, MA-COM, Hittite, Mini-Circuits, General Dynamics и др.);

Помимо этого, одним из направлений компании «ЭлектроПласт» является направление «Источники питания». Мы предлагаем Вам помощь Конструкторского отдела:

- Подбор оптимального решения, техническое обоснование при выборе компонента;
- Подбор аналогов;
- Консультации по применению компонента;
- Поставка образцов и прототипов;
- Техническая поддержка проекта;
- Защита от снятия компонента с производства.



Как с нами связаться

Телефон: 8 (812) 309 58 32 (многоканальный)

Факс: 8 (812) 320-02-42

Электронная почта: org@eplast1.ru

Адрес: 198099, г. Санкт-Петербург, ул. Калинина, дом 2, корпус 4, литера А.