

CMB-Series

THERMAL CIRCUIT BREAKERS

The CMB-Series is a compact, single pole, push-to-reset family of thermal circuit breakers designed to protect equipment. Utilizing simple, precision design with few moving parts, these breakers offer cost effective, extremely reliable circuit protection with high resistance against shock and vibration.



Resources:

[Configure a Complete Part](#)

[Download CAD & Sales Drawing >](#)

Product Highlights:

- Ratings from 3-20A, 125, 250VAC, 32VDC
- 2500 VAC/1 minute
- 60°C Max Operating Temperature
- 2500A @ 32VDC Interrupting Capacity
- 100M ohms Insulation Resistance
- Voltage drop <0.25 V
- UL, cUL, CSA, TUV, CE
- UL1500/ISO8846 for ignition protection/marine

Applications:

- Household Appliances
- On/Off-Highway
- Marine
- Power Strips
- Medical Equipment
- Audio Visual Equipment
- Power Supplies
- ROHS Compliant



CMB - 10 3 - 11 C 3 N - B - A /10

- | | | | | | | | | | |
|--------|--------|---------|---------------|--------------|--------------|-----------------|--------|----------|----------------|
| 1 | 2 | 3 | 4 | 5 | 6 | 7 | 8 | 9 | 10 |
| Series | Rating | Voltage | Mounting Hole | Bushing Type | Mounting Nut | Indicator Plate | Button | Terminal | Button Marking |

1 SERIES
CMB

3 VOLTAGE
3 125-250VAC/ 32 VDC

2 RATING

10 10 amps	12 12 amps
03 3 amps	13 13 amps
04 4 amps	14 14 amps
05 5 amps	15 15 amps
06 6 amps	16 16 amps
07 7 amps	20 20 amps
08 8 amps	

4 MOUNTING HOLE

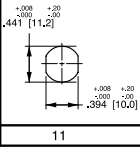
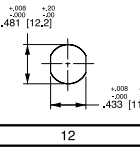
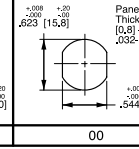
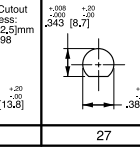
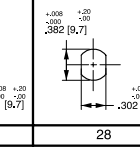
<p>11 1 M11</p> 	<p>12 2 M12</p> 	<p>00 3 Snap In Style</p> 	<p>27 15 3/8" 27 UNS</p> 	<p>28 12 3/8" 27 UNS (double flatted)</p> 
--	--	--	---	--

5 BUSHING
PLASTIC

C 4 Type C	D 4 Type D	E 5 Type E	H 6 Type H	G 8 Type G	K 13 Type K
-------------------	-------------------	-------------------	-------------------	-------------------	--------------------

METAL
J 8 Type J

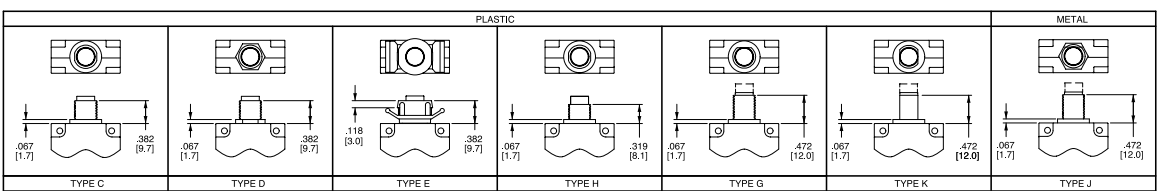

6 MOUNTING NUT 7

N None	1 Type 1	2 Type 2	3 11 Type 3	4 Type 4	5 Type 5	6 14 Type 6	7 9 Type 7	8 9 Type 8
---------------	-----------------	-----------------	--------------------	-----------------	-----------------	--------------------	-------------------	-------------------

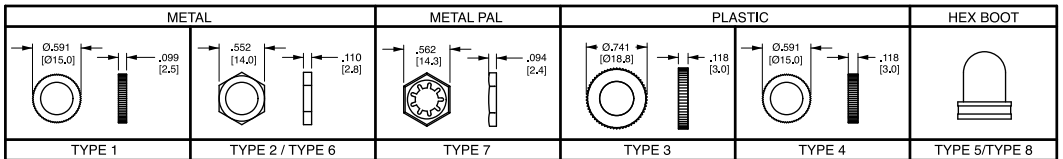

NOTE: Type 5 is clear hex boot. Type 8 is black hex boot (available for bushings G, J & K only); Type 3 nut includes molded in "PRESS TO RESET" marking.

7 INDICATOR PLATE 7

N None	A Embossed Legend
B Silver Printing on Black	

All indicator plates are marked "Suppl. Prot. press to reset".

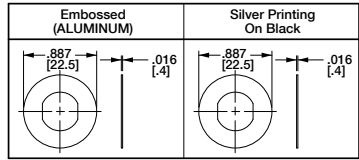

Notes: All dimensions are in [mm]. Tolerance ±.005 [.127] unless otherwise specified.

- | | |
|---|--|
| <p>1 Used with bushing C or D only.</p> <p>2 Used with H bushing only.</p> <p>3 Used with bushing E only.</p> <p>4 Used with M11 mounting hole only.</p> <p>5 Used with mounting hole 00 only.</p> <p>6 Used with M12 mounting hole only.</p> <p>7 All hardware available separately. Consult factory.</p> <p>8 Available with mounting hole 27 only.</p> <p>9 Available with G, J or K bushing only.</p> | <p>10 Amp rating must match button marking (ex: 20 will be marked on the button of CMB-203-27G3N-W-A/20)</p> <p>11 Includes molded in "PRESS TO RESET" marking.</p> <p>12 Available with K bushing only.</p> <p>13 Available with mounting hole 28 only.</p> <p>14 Thickness is 3.0 mm, .118 in.</p> <p>15 Available with G or J bushing only.</p> |
|---|--|

8 BUTTON

B Black	R Red	W White
----------------	--------------	----------------

9 TERMINAL

A Type A	B Type B	C Type C	D Type D	E Type E	F Type F	G Type G	H Type H	J Type J	K Type K	R Type R
-----------------	-----------------	-----------------	-----------------	-----------------	-----------------	-----------------	-----------------	-----------------	-----------------	-----------------

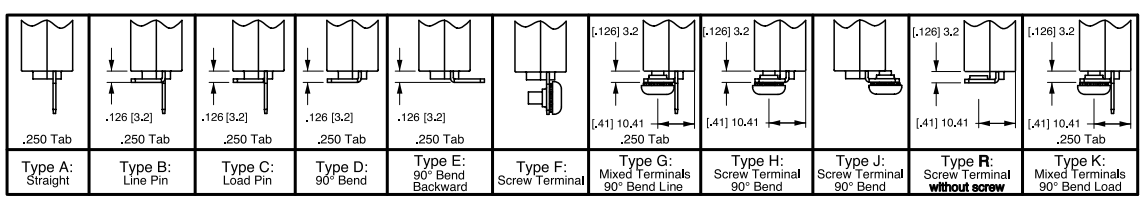

F,G,H,J TERMINALS ARE 8-32 UNC

10 BUTTON MARKING (IF BLANK, NO MARKING)¹⁰ Button Marking Orientation: line 20 load

03 3 amp	05 5 amp	07 7 amp	10 10 amp	13 13 amp	15 15 amp	20 20 amp
04 4 amp	06 6 amp	08 8 amp	12 12 amp	14 14 amp	16 16 amp	

*Manufacturer reserves the right to change product specification without prior notice.

Dimensional Specifications: in. [mm]

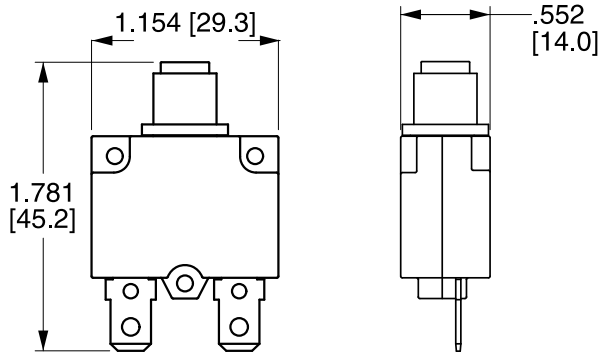

Time Delay

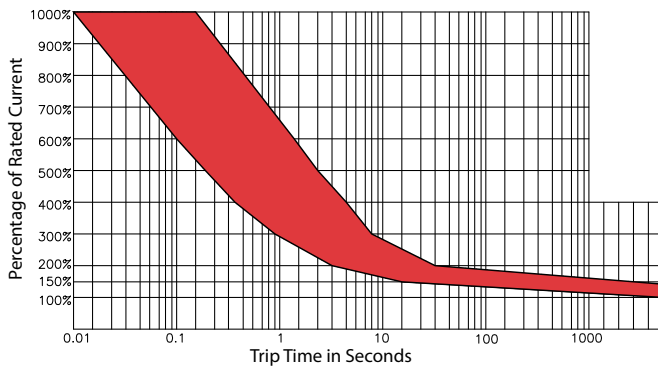

Overload	Trip Time
100%	No Trip
150%	Trip in 1 hr
200%	4.0 ~ 40 sec.
300%	0.9 ~ 8.0 sec.
400%	0.42 ~ 5.0 sec.
500%	0.25 ~ 3.0 sec.
600%	0.01 ~ 1.8 sec.

Time Trip Factor ¹	
-10 °C	x 1.70
-5 °C	x 1.60
0 °C	x 1.50
5 °C	x 1.40
10 °C	x 1.30
15 °C	x 1.20
20 °C	x 1.10
25 °C	x 1.00

Time Trip Factor ¹	
30 °C	x 0.90
35 °C	x 0.85
40 °C	x 0.80
45 °C	x 0.75
50 °C	x 0.70
55 °C	x 0.65
60 °C	x 0.60

Notes:

1. Trip Time factor is a guideline that indicates ambient temperature effect on trip times at various overload values.

Authorized Sales Representatives and Distributors

Click on a region of the map below to find your local representatives and distributors or visit www.carlingtech.com/findarep.



About Carling

Founded in 1920, Carling Technologies is a leading manufacturer of electrical and electronic switches and assemblies, circuit breakers, electronic controls, power distribution units, and multiplexed power distribution systems. With four ISO9001 and IATF16949 registered manufacturing facilities and technical sales offices worldwide, Carling Technologies Sales, Service and Engineering teams do much more than manufacture electrical components, they engineer powerful solutions! To learn more about Carling please visit www.carlingtech.com/company-profile.

To view all of Carling's environmental, quality, health & safety certifications please visit www.carlingtech.com/environmental-certifications

Worldwide Headquarters

Carling Technologies, Inc.
60 Johnson Avenue, Plainville, CT 06062
Phone: 860.793.9281 **Fax:** 860.793.9231
Email: sales@carlingtech.com

Northern Region Sales Office: nrsm@carlingtech.com
Southeast Region Sales Office: sersm@carlingtech.com
Midwest Region Sales Office: mrsms@carlingtech.com
West Region Sales Office: wrsm@carlingtech.com
Latin America Sales Office: larsm@carlingtech.com

Asia-Pacific Headquarters

Carling Technologies, Asia-Pacific Ltd.,
Suite 1607, 16/F Tower 2, The Gateway,
Harbour City, 25 Canton Road,
Tsimshatsui, Kowloon, Hong Kong
Phone: Int + 852-2737-2277 **Fax:** Int + 852-2736-9332
Email: sales@carlingtech.com.hk

Shenzhen, China: shenzhen@carlingtech.com
Shanghai, China: shanghai@carlingtech.com
Pune, India: india@carlingtech.com
Kaohsiung, Taiwan: taiwan@carlingtech.com
Yokohama, Japan: japan@carlingtech.com

Europe | Middle East | Africa Headquarters

Carling Technologies LTD
4 Airport Business Park, Exeter Airport,
Clyst Honiton, Exeter, Devon, EX5 2UL, UK
Phone: Int + 44 1392.364422 **Fax:** Int + 44 1392.364477
Email: ltd.sales@carlingtech.com

Germany: gmbh@carlingtech.com
France: sas@carlingtech.com



Carling Technologies®

Innovative Designs. Powerful Solutions.



Компания «ЭлектроПласт» предлагает заключение долгосрочных отношений при поставках импортных электронных компонентов на взаимовыгодных условиях!

Наши преимущества:

- Оперативные поставки широкого спектра электронных компонентов отечественного и импортного производства напрямую от производителей и с крупнейших мировых складов;
- Поставка более 17-ти миллионов наименований электронных компонентов;
- Поставка сложных, дефицитных, либо снятых с производства позиций;
- Оперативные сроки поставки под заказ (от 5 рабочих дней);
- Экспресс доставка в любую точку России;
- Техническая поддержка проекта, помощь в подборе аналогов, поставка прототипов;
- Система менеджмента качества сертифицирована по Международному стандарту ISO 9001;
- Лицензия ФСБ на осуществление работ с использованием сведений, составляющих государственную тайну;
- Поставка специализированных компонентов (Xilinx, Altera, Analog Devices, Intersil, Interpoint, Microsemi, Aeroflex, Peregrine, Syfer, Eurofarad, Texas Instrument, Miteq, Cobham, E2V, MA-COM, Hittite, Mini-Circuits, General Dynamics и др.);

Помимо этого, одним из направлений компании «ЭлектроПласт» является направление «Источники питания». Мы предлагаем Вам помощь Конструкторского отдела:

- Подбор оптимального решения, техническое обоснование при выборе компонента;
- Подбор аналогов;
- Консультации по применению компонента;
- Поставка образцов и прототипов;
- Техническая поддержка проекта;
- Защита от снятия компонента с производства.



Как с нами связаться

Телефон: 8 (812) 309 58 32 (многоканальный)

Факс: 8 (812) 320-02-42

Электронная почта: org@eplast1.ru

Адрес: 198099, г. Санкт-Петербург, ул. Калинина, дом 2, корпус 4, литера А.