

SEMITEC[®]

Ishizuka Electronics Corporation

PRODUCT CATALOG





SURGE ABSORBERS

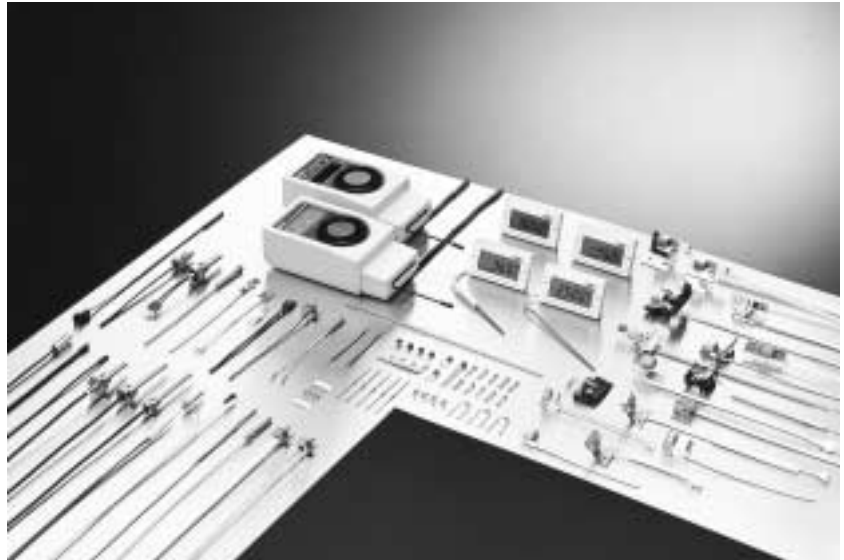

SENSORS AND MODULES



THERMISTORS

NON-CONTACT SENSOR <ul style="list-style-type: none"> · THERMOPILE · NC SENSOR 	4
THERMISTOR <ul style="list-style-type: none"> · HIGH PRECISION SERIES · SMD SERIES · HIGH HEAT-RESISTANCE SERIES · DISK SERIES · SENSORS 	6
POWER THERMISTOR <ul style="list-style-type: none"> · D-TYPE SERIES · MARK II SERIES · D2-TYPE SERIES 	21
VRD (TRANSIENT VOLTAGE SUPPRESSOR) <ul style="list-style-type: none"> · LEAD TYPE SERIES · SMD SERIES 	26
CRD (CURRENT REGULATIVE DIODE) <ul style="list-style-type: none"> · LEAD TYPE SERIES · MELF TYPE SERIES 	30
ZENAMIC (METAL OXIDE VARISTOR) <ul style="list-style-type: none"> · LEAD TYPE SERIES · M TYPE SERIES · SURGE ABSORBER UNIT SERIES 	32
GAS TUBE ARRESTER <ul style="list-style-type: none"> · CERAMIC TUBE SERIES · GLASS TUBE SERIES · SA-01 SERIES 	40

THERMOPILE TYPE INFRARED SENSOR

THERMOPILE

Thermopile type Infrared sensor
utilizing own silicon micromachining
technology.

Applications: Eardrum thermometer
Microwave oven
Non contact temperature measurement



Part number

Part No.	type	Thermistor
15TP551T	TO5	Built-in
15TP551N		—
10TP581T	TO18	Built-in

Dimensions

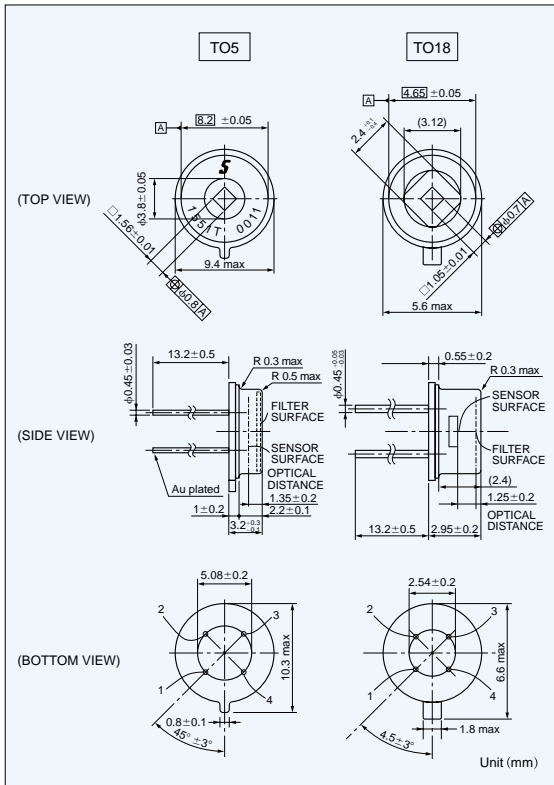

Ratings

Parameters	Value		Unit	Conditions
	15TP551	10TP581		
Sensitive area	1.56×1.56	1.05×1.05	mm ²	Size of Absorbing Film
*1 Responsivity	16±30%	15±30%	V/W	
*1 Output Voltage	490±30%	200±30%	μV	
*2 Output Voltage	2.49±30%	1.00±30%	mV	
*1 Temperature Coefficient of Responsivity	0.01±0.02	0.02±0.02	% / °C	Reference
Thermopile Resistors	55±30%	65±30%	kΩ	
Temperature Coefficient of Thermopile Resistance	±0.1	±0.1	% / °C	
Johnson Noise Voltage	30	33	nV / √Hz	Johnson Noise r.m.s., 298K 1Hz Typical
*1 S/N Ratio	84.2	75.7	dB	Output Voltage/Johnson Noise, Typical
*1 Noise Equivalent Power	1.9	2.2	nW/Hz ^{1/2}	Typical
*1 Specific Detectivity	8.4×10 ⁷	4.7×10 ⁷	cm·Hz ^{1/2} /W	Typical
Time Constant	45	15	ms	Typical
Operating Temperature range	-20~100	-20~100	°C	
Storage Temperature range	-40~100	-40~100	°C	
Filter Range	Cut on 5	Cut on 5	μm	Standard
Field of View	±45	±50	deg.	Incident Angle to Achieve 50% Responsivity
Insulation Resistance	≥500	≥500	MΩ	Application of DC25V
Sealing	≤1×10 ⁻⁹	≤1×10 ⁻⁹	Pa·m ³ /s	
*3 Thermistor Resistance Value	100±3%	100±3%	kΩ	Rated zero-power resistance Value at 25°C
*3 Thermistor B-Value	3435±0.7%	3435±0.7%	K	
*3 Thermistor Rated Power	0.5	0.5	mW	at 25°C

*1 Test Condition
Blackbody Temperature : 500K
Sensor-Blackbody Distance : 100mm
Sensor Temperature : 298K
Aperture size : φ12.7mm

*2 Test Condition
Blackbody Temperature : 310K
Sensor Temperature : 298K

*3 Built-in Type

NON-CONTACT SENSOR (Infrared sensing temperature detector)



NC SENSOR

NC SENSOR is the remote temperature sensor consisting of two precision thermistors.

1.Features

- Larger output in comparison with other IR sensors.
- Operating temperature of up 150°C.
- Minimum negative influence caused by a dew and/or dust.

2.Applications

- Temperature measurement of the LBP and PPC heat-roller.
- White goods such as microwave-ovens, air-conditioner, refrigerator and so on.
- Any other measurement requiring the remote-sensing.



3. Dimensions

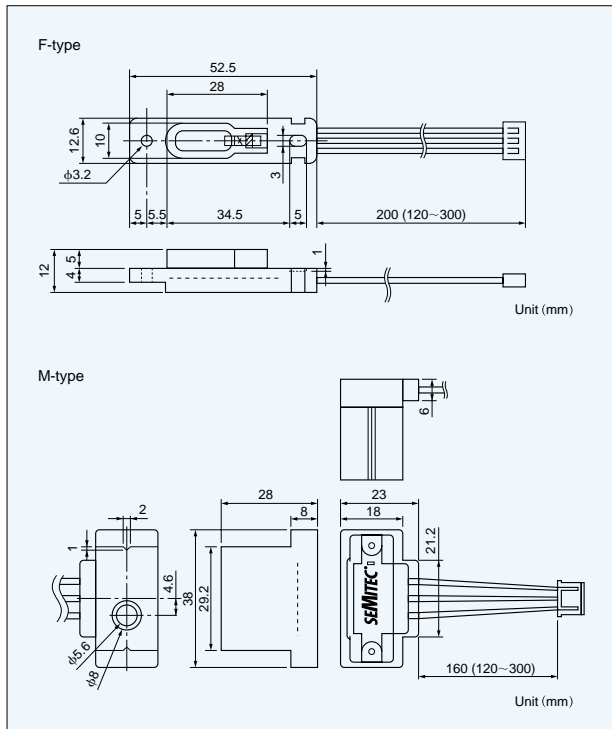

4.Specification

Parameters	F-type (for heat-roller)		M-type (for microwave ovens)	
	Performance	Conditions	Performance	Conditions
Temperature Accuracy	180°C±3°C	Blackbody Temperature : 180°C Thermal Emissivity : 0.96 Temperature compensation : 100°C Roller Size : 40mm Testing Distance : 5mm Resistor Connected : 33.0Ω Power Line Voltage : DC 5.000V	60°C±5°C	Blackbody Temperature : 60°C Thermal Emissivity : 0.995 Temperature compensation : 25°C Resistor Connected : 68.0Ω Power Line Voltage : DC 5.000V
Operating Temperature Range	-10°C~150°C			
Temperature Detecting range	-10°C~260°C		-10°C~100°C	

THERMISTOR

"Thermistor" is the generic name given to thermally sensitive resistors.

Negative temperature coefficient thermistor is generally called as thermistor. Thermistor is a semiconducting ceramic resistor produced by sintering the materials at high temperature and made mainly from metal oxide.

Depending on the manufacturing method and the structure, there are many shapes and characteristics for various purposes such as temperature measurement, temperature compensation and etc.

The thermistor resistance values, unless otherwise specified, are classified at a standard temperature of 25°C.

B constant is calculated from the resistance values at 25°C and 85°C.

Resistance - Temperature Characteristics

The resistance of a temperature is solely a function of its absolute temperature. Since electrical power being dissipated within a temperature might heat above its ambient temperature and thereby reduce its resistance, it is necessary to test for resistance with temperature. The resistance so measured is called R_T , which means the resistance at essentially zero-power.

The mathematical expression which relates the resistance and the absolute temperature of a thermistor is as follows:

$$R_a = R_b \exp \left[B \left(\frac{1}{T_1} - \frac{1}{T_2} \right) \right]$$

Where: R_a is the resistance at absolute temperature T_1
 R_b is the resistance at absolute temperature T_2
 B is a constant which depends on the material of the thermistor

Unless otherwise specified, all values of B are determined from measurements made at 25°C and 85°C.

The temperature coefficient of resistance α is expressed in the following equation:

$$\alpha = - \frac{B}{T^2} \times 100 (\%/^{\circ}\text{C})$$

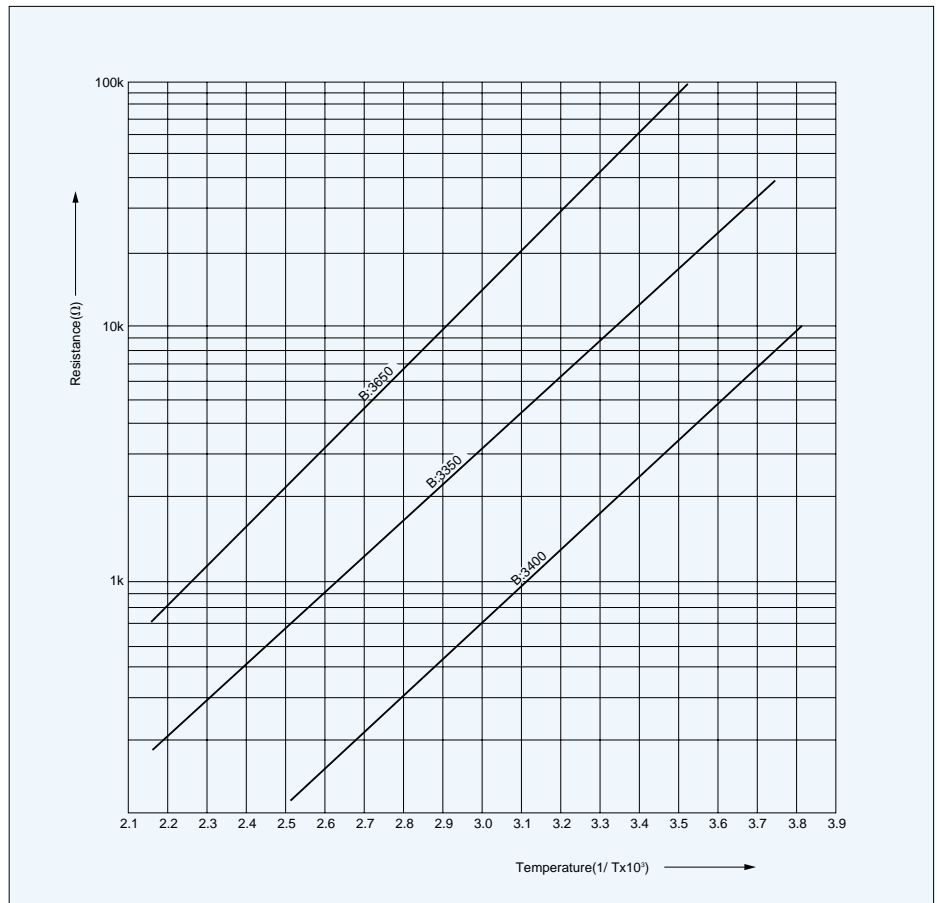

Dissipation factor

Dissipation factor (δ) is power in milliwatts required to raise thermistor temperature 1°C. Measured with thermistor suspended by its leads in a specified environment.

$$\delta = \frac{P}{\Delta t} (\text{mW}/^{\circ}\text{C})$$

P : Power (mW)

Δt : Raise temperature (°C)

Thermal time constant

Thermal time constant (τ_a) is the time required by a thermistor to change 63% of the difference between its initial and final temperature. Measured with thermistor suspended by its leads in specified environment.

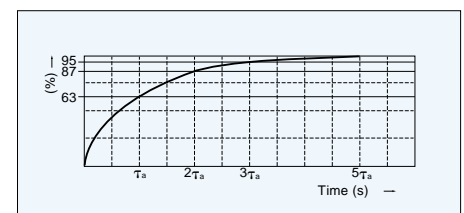

ULTIMATE THINNESS, JT THERMISTOR

500 μ m only

JT THERMISTOR

JT thermistors feature ultra thinness of 500 μ m and superior electrical insulation. It is possible to use with safety in ambience that might contact with electrodes.

Part number

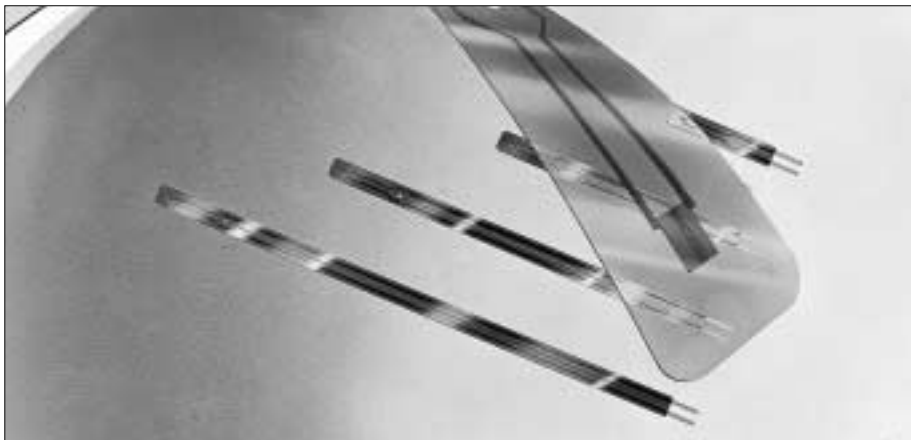
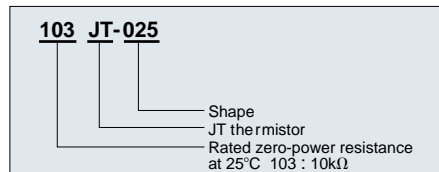

Dimensions

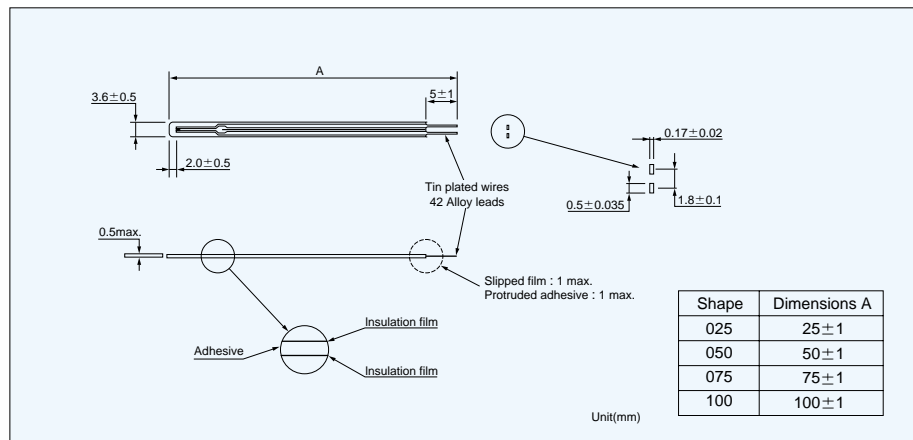

Resistance-Temperature

Temperature (°C)	Type	
	103JT	104JT
-50	367.7	9584
-40	204.7	4572
-30	118.5	2282
-20	71.02	1191
-10	43.67	647.2
0	27.70	365.0
10	18.07	212.5
20	12.11	127.7
30	8.301	78.88
40	5.811	50.03
50	4.147	32.51
60	3.011	21.61
70	2.224	14.66
80	1.668	10.13
90	1.267	7.135
100		5.111
110		3.720
120		2.746
125		2.371

Unit(k Ω)

Specifications

Part No.	R ₂₅ *1	B value*2	Dissipation factor (mW/°C)	Thermal time constant(s)*3	Rated power at 25°C(mW)	Operating temp. range(°C)
103JT-□□□	10k Ω \pm 1%	3435K \pm 1%	0.7	5	3.5	-50~90
104JT-□□□	100k Ω \pm 1%	4390K \pm 1%	0.7	5	3.5	-50~125

*1 R₂₅ : Rated zero-power resistance value at 25°C, \pm 2% and 3% are also available.

*2 B value : determined by rated zero-power resistance at 25°C and 85°C.

*3 Time when thermistor temperature reaches 63.2% of the temperature difference. The value is measured in the air.

HIGH PRECISION THERMISTOR

AT THERMISTOR

The AT thermistor is a high-precision thermal sensing device featuring extremely small B-value tolerance and resistance.

When used as a temperature gauge, the AT thermistor requires no adjustment between the control circuit and the sensor.

This insures temperature precision of $\pm 0.3^{\circ}\text{C}$. Temperature indicators and control instruments are now available for use with the thermistor.

Part number

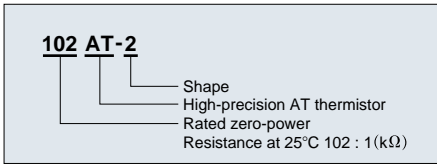

Dimensions

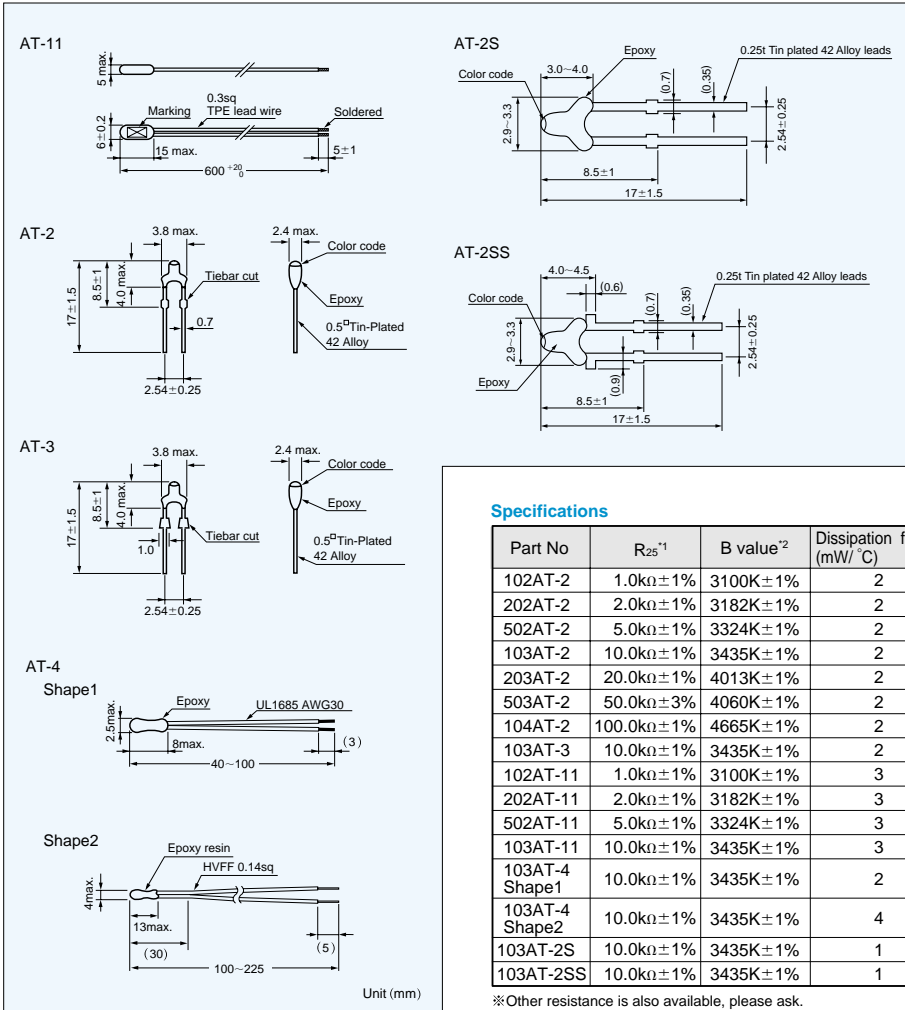

Resistance tolerance

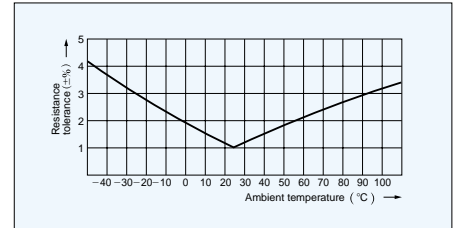

Interchange precision

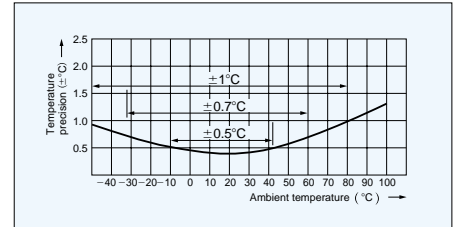

Specifications

Part No	R ₂₅ ¹	B value ²	Dissipation factor (mW/°C)	Thermal time constant (s) ³	Rated power at 25°C (mW)	Operating temp. range(°C)	Color code
102AT-2	1.0k Ω ±1%	3100K±1%	2	15	10	-50~90	Black
202AT-2	2.0k Ω ±1%	3182K±1%	2	15	10	-50~90	Red
502AT-2	5.0k Ω ±1%	3324K±1%	2	15	10	-50~110	Yellow
103AT-2	10.0k Ω ±1%	3435K±1%	2	15	10	-50~110	White
203AT-2	20.0k Ω ±1%	4013K±1%	2	15	10	-50~110	None
503AT-2	50.0k Ω ±3%	4060K±1%	2	15	10	-50~110	None
104AT-2	100.0k Ω ±1%	4665K±1%	2	15	10	-50~110	None
103AT-3	10.0k Ω ±1%	3435K±1%	2	15	10	-50~110	White
102AT-11	1.0k Ω ±1%	3100K±1%	3	75	15	-50~90	None
202AT-11	2.0k Ω ±1%	3182K±1%	3	75	15	-50~90	None
502AT-11	5.0k Ω ±1%	3324K±1%	3	75	15	-50~105	None
103AT-11	10.0k Ω ±1%	3435K±1%	3	75	15	-50~105	None
103AT-4 Shape1	10.0k Ω ±1%	3435K±1%	2	10	10	-30~90	None
103AT-4 Shape2	10.0k Ω ±1%	3435K±1%	4	35	20	-30~90	None
103AT-2S	10.0k Ω ±1%	3435K±1%	1	15	5	-50~110	white
103AT-2SS	10.0k Ω ±1%	3435K±1%	1	15	5	-50~110	white

*Other resistance is also available, please ask.

¹ R₂₅: Rated zero-power resistance value at 25°C.

² B value: determined by rated zero-power resistance at 25°C and 85°C.

³ Time when thermistor temperature reaches 63.2% of the temperature difference. The value is measured in the air.

AT-5 THERMISTOR

AT-5 thermistor is available in taping.

Part number

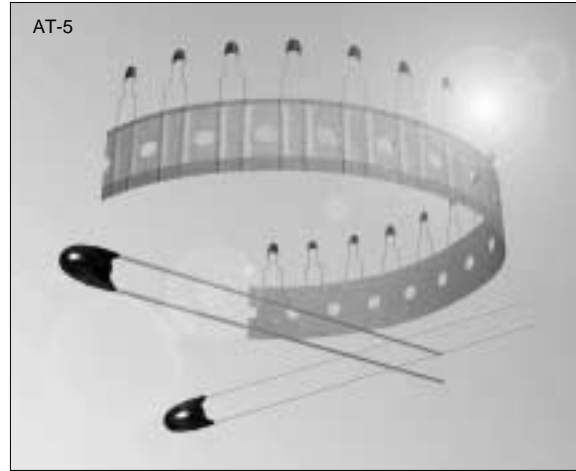

Dimensions



Specifications

Part No	R ₂₅ ※1	B value ※2	Dissipation factor (mW/°C)	Thermal time constant (s) ※3	Rated power at 25°C (mW)	Operating temp. range(°C)
103AT-5	10.0kΩ±1%	3435K±1%	2.5	15	10	-50~110

※Other resistance is also available, please ask.

※1 R₂₅ : Rated zero-power resistance value at 25°C.

※2 B value : determined by rated zero-power resistance at 25°C and 85°C.

※3 Time when thermistor temperature reaches 63.2% of the temperature difference. The value is measured in the air.

Taping

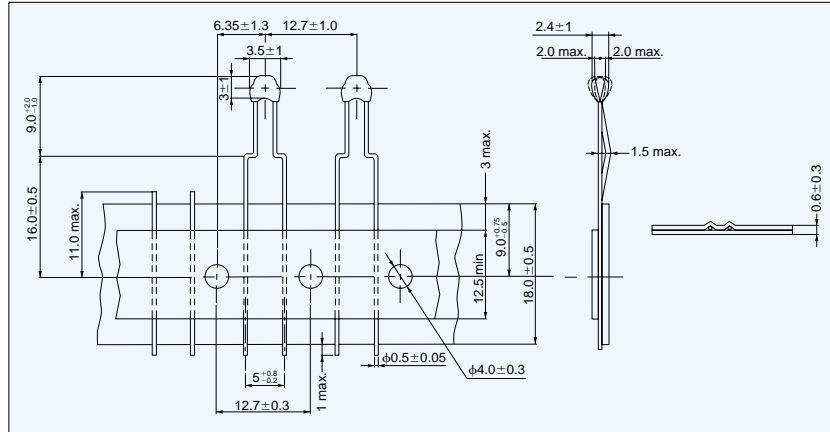

Resistance -Temperature

Temperature (°C)	102AT	202AT	502AT	Type				103AT	203AT	503AT	104AT	Temperature (°C)	102AT	202AT	502AT	Type				103AT	203AT	503AT	104AT
-50	24.46	55.66	154.6	329.5	1253	3168	11473	35	0.7229	1.424	3.508	6.940	13.06	32.48	60.94								
-45	18.68	42.17	116.5	247.7	890.5	2257	7781	40	0.6189	1.211	2.961	5.827	10.65	26.43	48.10								
-40	14.43	32.34	88.91	188.5	642.0	1632	5366	45	0.5316	1.033	2.509	4.911	8.716	21.59	38.13								
-35	11.23	24.96	68.19	144.1	465.8	1186	3728	50	0.4587	0.8854	2.137	4.160	7.181	17.75	30.44								
-30	8.834	19.48	52.87	111.3	342.5	872.8	2629	55	0.3967	0.7620	1.826	3.536	5.941	14.64	24.42								
-25	6.998	15.29	41.21	86.43	253.6	646.3	1864	60	0.3446	0.6587	1.567	3.020	4.943	12.15	19.72								
-20	5.594	12.11	32.44	67.77	190.0	484.3	1340	65	0.3000	0.5713	1.350	2.588	4.127	10.13	15.99								
-15	4.501	9.655	25.66	53.41	143.2	364.6	969.0	70	0.2622	0.4975	1.168	2.228	3.464	8.482	13.05								
-10	3.651	7.763	20.48	42.47	109.1	277.5	709.5	75	0.2285	0.4343	1.014	1.924	2.916	7.129	10.68								
-5	2.979	6.277	16.43	33.90	83.75	212.3	523.3	80	0.1999	0.3807	0.8835	1.668	2.468	6.022	8.796								
0	2.449	5.114	13.29	27.28	64.88	164.0	390.3	85	0.1751	0.3346	0.7722	1.451	2.096	5.105	7.271								
5	2.024	4.188	10.80	22.05	50.53	127.5	292.5	90	0.1536	0.2949	0.6771	1.266	1.788	4.345	6.041								
10	1.684	3.454	8.840	17.96	39.71	99.99	221.5	95			0.5961	1.108	1.530	3.712	5.037								
15	1.408	2.862	7.267	14.69	31.36	78.77	168.6	100			0.5265	0.9731	1.315	3.185	4.220								
20	1.184	2.387	6.013	12.09	24.96	62.56	129.5	105			0.4654	0.8572	1.134	2.741	3.546								
25	1.000	2.000	5.000	10.00	20.00	50.00	100.0	110			0.4128	0.7576	0.9807	2.369	2.994								
30	0.8486	1.684	4.179	8.313	16.12	40.20	77.81																

Unit(kΩ)

ET THERMISTOR

The ET thermistor is smaller version of the AT thermistor. Its fast response time and high reliability makes it particularly suitable for use in medical equipment and thermometers. Manufactured by full-automated production line, all ET thermistors have identical size and that makes it possible to assemble sensors automatically.

Part number

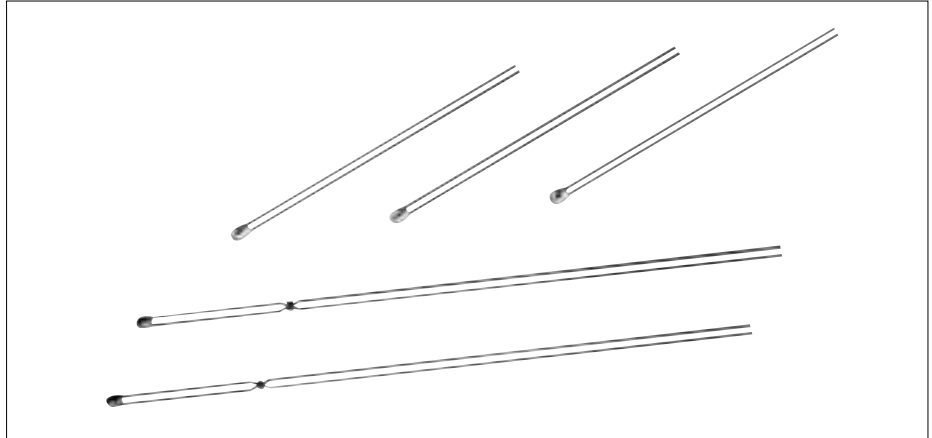
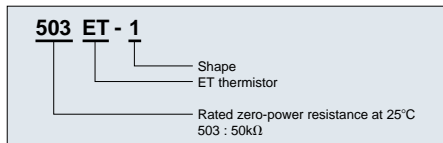

Dimensions



Specifications

Part No.	R ₂₅ *1	B value*2	Dissipation factor (mW/°C)	Thermal time constant (s)*3	Rated power at 25°C(mW)	Operating temp. range (°C)
402ET-1(2)	4.0kΩ±3%	3100K±1%	0.7	6	3.5	-40~ 90
103ET-1(2)	10.0kΩ±3%	3250K±1%	0.7	6	3.5	-40~ 90
303ET-1(2)	30.0kΩ±3%	3760K±1%	0.7	6	3.5	-40~100
403ET-1(2)	40.0kΩ±3%	3525K±1%	0.7	6	3.5	-40~100
413ET-1(2)	41.0kΩ±3%	3435K±1%	0.7	6	3.5	-40~100
503ET-1(2)	50.0kΩ±3%	4055K±1%	0.7	6	3.5	-40~100
593ET-1(2)	59.0kΩ±3%	3617K±1%	0.7	6	3.5	-40~100
833ET-1(2)	83.0kΩ±3%	4013K±1%	0.7	6	3.5	-40~100
104ET-1(2)	100.0kΩ±3%	4132K±1%	0.7	6	3.5	-40~ 90
224ET-1(2)	226.0kΩ±3%	4021K±1%	0.7	6	3.5	-40~100
234ET-1(2)	232.0kΩ±3%	4274K±1%	0.7	6	3.5	-40~100
103ETB	10.0kΩ±2%	3435K±1%	0.7	6	3.5	-40~ 90
503ET-3	50.0kΩ±2%	4086K±1%	0.7	6	3.5	-40~100

*1 R₂₅: Rated zero-power resistance value at 25°C.
 *2 B value: determined by rated zero-power resistance at 25°C and 85°C.
 *3 Time when thermistor temperature reaches 63.2% of the temperature difference. The value is measured in the air.

Resistance-Temperature

Temperature (°C)	Type											
	402ET	103ET	303ET	403ET	413ET	503ET	593ET	833ET	104ET	224ET	234ET	103ETB
-40	57.71	170.9	810.7	833.3	772.8	1602	1318	2664	3325	7005	9046	204.7
-30	35.34	102.2	445.1	481.1	456.5	855.0	754.3	1421	1769	3784	4680	118.5
-20	22.38	63.07	253.7	287.5	277.9	474.4	445.8	788.5	977.5	2116	2515	71.02
-10	14.60	40.08	149.8	177.2	174.1	272.7	271.7	453.0	559.0	1225	1401	43.67
0	9.797	26.16	91.30	112.4	111.7	161.9	170.1	269.3	329.8	730.1	808.2	27.70
10	6.737	17.51	57.31	73.00	73.63	99.13	109.4	164.8	200.5	447.8	480.2	18.07
20	4.736	11.99	37.00	48.61	49.57	62.38	72.10	103.6	125.3	282.1	293.7	12.11
30	3.394	8.387	24.47	33.08	34.08	40.24	48.55	66.91	80.27	182.1	184.4	8.301
40	2.476	5.988	16.56	22.96	23.89	26.58	33.41	44.18	52.62	120.3	118.6	5.811
50	1.835	4.353	11.45	16.26	17.06	17.93	23.44	29.80	35.23	81.07	78.00	4.147
60	1.378	3.217	8.070	11.70	12.38	12.33	16.73	20.51	24.00	55.75	52.39	3.011
70	1.049	2.414	5.791	8.569	9.135	8.588	12.15	14.37	16.59	39.01	35.87	2.224
80	0.7997	1.836	4.222	6.367	6.838	6.064	8.951	10.24	11.64	27.78	24.99	1.668
90	0.6145	1.416	3.125	4.797	5.190	4.338	6.697	7.419	8.287	20.10	17.72	1.267
100			2.346	3.662	3.990	3.142	5.077	5.459		14.75	12.75	

Unit (kΩ)

Specifications for clinical thermo-meter

Temperature (°C)	Type			
	503ET	833ET	224ET	234ET
R ₃₀	40.22	67.04	182.4	184.5
R ₃₇	30.00	50.00	136.0	135.0
R ₄₅	21.75	36.25	98.56	95.87
B _{30/45} (K)	3953	3953	3958	4209

Unit (kΩ)

ACCURATE AXIAL TYPE THERMISTOR

IT THERMISTOR

Our newly developed IT thermistors are axial leaded diode type packaged in high-density resin mold and featured strength against various operating environments.

We offer IT thermistor with $\pm 2\%$ tolerance for a resistance value of 25°C and $\pm 1\%$ for B value. IT thermistors are the most appropriate device for accurate temperature control below 100°C.

Part number



Dimensions



Package

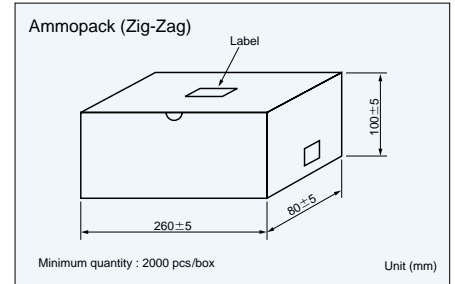

Taping



Specifications

Part No.	R ₂₅ *1	B value*2	Dissipation factor (mW/°C)	Thermal time constant (s)*3	Rated power at 25°C (mW)	Operating temp. range (°C)
302IT	3.0kΩ±2%	3860K±1%	3.6	13.5	18.0	-50~125
502IT	5.0kΩ±2%	3860K±1%	3.6	13.5	18.0	-50~125
103IT	10.0kΩ±2%	3435K±1%	3.6	13.5	18.0	-50~100
203IT	20.0kΩ±2%	3760K±1%	3.6	13.5	18.0	-50~125
303IT	30.0kΩ±2%	3760K±1%	3.6	13.5	18.0	-50~125
503IT	50.0kΩ±2%	4055K±1%	3.6	13.5	18.0	-50~125
104IT	100.0kΩ±2%	4390K±1%	3.6	13.5	18.0	-50~125

*1 R₂₅: Rated zero-power resistance value at 25°C, $\pm 1\%$ and 3% are also available.

*2 B value: determined by rated zero-power resistance at 25°C and 85°C.

*3 Time when thermistor temperature reaches 63.2% of the temperature difference. The value is measured in the air.

Resistance-Temperature

Temperature (°C)	Type								Temperature (°C)	Type							
	302IT	502IT	103IT	203IT	303IT	503IT	104IT	302IT		502IT	103IT	203IT	303IT	503IT	104IT		
-50	182.1	303.4	367.7	1026	1539	3135	9584	50	1.109	1.849	4.147	7.632	11.45	17.93	32.51		
-40	93.35	155.6	204.7	540.5	810.8	1602	4572	60	0.7744	1.291	3.011	5.380	8.070	12.33	21.61		
-30	49.85	83.09	118.5	296.7	445.1	855.0	2282	70	0.5513	0.9189	2.224	3.861	5.792	8.588	14.66		
-20	27.75	46.25	71.02	169.2	253.8	474.4	1191	80	0.4000	0.6667	1.668	2.815	4.223	6.064	10.13		
-10	16.02	26.70	43.67	99.85	149.8	272.7	647.2	90	0.2951	0.4918	1.267	2.083	3.125	4.338	7.135		
0	9.541	15.90	27.70	60.87	91.31	161.9	365.0	100	0.2210	0.3683	0.9753	1.564	2.346	3.142	5.111		
10	5.876	9.793	18.07	38.21	57.32	99.13	212.5	110	0.1680	0.2800		1.190	1.785	2.302	3.720		
20	3.728	6.214	12.11	24.66	36.99	62.38	127.7	120	0.1295	0.2158		0.9159	1.374	1.705	2.746		
30	2.431	4.051	8.301	16.31	24.47	40.24	78.88	125	0.1142	0.1903		0.8067	1.210	1.472	2.371		
40	1.623	2.705	5.811	11.04	16.56	26.58	50.03										

Unit (kΩ)

SURFACE MOUNT TYPE THERMISTOR

HT THERMISTOR

HT thermistors are entirely new type of thermistor for surface mounting (by reflow soldering) and were acquired from advanced technology.

Our HT thermistors are adapted metal electrodes packaged in a resin mold, unlike conventional chip thermistors, and can offer $\pm 2\%$ tolerance for a resistance value at 25°C.

HT series (SMD Thermistor) is not only compact-surface mounting type but also highly accurate and reliable.

Part number

103	HT	-□□	-TP
			Taping HTF only
			Tolerance of R ₂₅
			1P : $\pm 1\%$ 2P : $\pm 2\%$
			Shape
			Rated zero-power resistance at 25°C 103 : 10k Ω

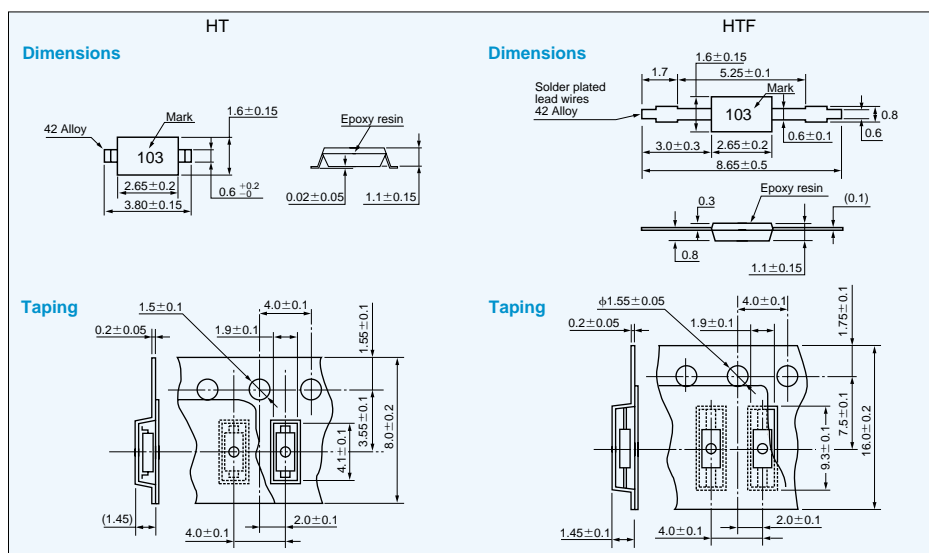

Specifications

Minimum quantity: 3000pcs/reel Unit (mm)

Part No.	R ₂₅ *1	B value*2	Dissipation factor (mW/°C)	Thermal time constant (s)*3	Rated power at 25°C (mW)	Operating temp. range (°C)
302HT(F)	3.0k Ω $\pm 2\%$	3860K $\pm 1\%$	1.0	8.0	5.0	-50~125
502HT(F)	5.0k Ω $\pm 2\%$	3860K $\pm 1\%$	1.0	8.0	5.0	-50~125
103HT(F)	10.0k Ω $\pm 2\%$	3435K $\pm 1\%$	1.0	8.0	5.0	-50~100
203HT(F)	20.0k Ω $\pm 2\%$	3760K $\pm 1\%$	1.0	8.0	5.0	-50~125
303HT(F)	30.0k Ω $\pm 2\%$	3760K $\pm 1\%$	1.0	8.0	5.0	-50~125
503HT(F)	50.0k Ω $\pm 2\%$	4055K $\pm 1\%$	1.0	8.0	5.0	-50~125
104HT(F)	100.0k Ω $\pm 2\%$	4390K $\pm 1\%$	1.0	8.0	5.0	-50~125

*1 R₂₅: Rated zero-power resistance value at 25°C, $\pm 1\%$ and 3% are also available.

*2 B value: determined by rated zero-power resistance at 25°C and 85°C.

*3 Time when thermistor temperature reaches 63.2% of the temperature difference. The value is measured in the air.

Resistance-Temperature

Temperature (°C)	Type								Temperature (°C)	Type							
	302HT	502HT	103HT	203HT	303HT	503HT	104HT	302HT		502HT	103HT	203HT	303HT	503HT	104HT		
-50	182.1	303.4	367.7	1026	1539	3135	9584	50	1.109	1.849	4.147	7.632	11.45	17.93	32.51		
-40	93.35	155.6	204.7	540.5	810.8	1602	4572	60	0.7744	1.291	3.011	5.380	8.070	12.33	21.61		
-30	49.85	83.09	118.5	296.7	445.1	855.0	2282	70	0.5513	0.9189	2.224	3.861	5.792	8.588	14.66		
-20	27.75	46.25	71.02	169.2	253.8	474.4	1191	80	0.4000	0.6667	1.668	2.815	4.223	6.064	10.13		
-10	16.02	26.70	43.67	99.85	149.8	272.7	647.2	90	0.2951	0.4918	1.267	2.083	3.125	4.338	7.135		
0	9.541	15.90	27.70	60.87	91.31	161.9	365.0	100	0.2210	0.3683	0.9753	1.564	2.346	3.142	5.111		
10	5.876	9.793	18.07	38.21	57.32	99.13	212.5	110	0.1680	0.2800		1.190	1.785	2.302	3.720		
20	3.728	6.214	12.11	24.66	36.99	62.38	127.7	120	0.1295	0.2158		0.9159	1.374	1.705	2.746		
30	2.431	4.051	8.301	16.31	24.47	40.24	78.88	125	0.1142	0.1903		0.8067	1.210	1.472	2.371		
40	1.623	2.705	5.811	11.04	16.56	26.58	50.03										

Unit (k Ω)

THIN FILM TYPE THERMISTOR

FT THERMISTOR

The FT thermistors, the highly reliable thermistors, are characterized by their fast response time, which was made possible by the miniaturization of the thermistor dimensions. FT thermistors are also heat-resistant type. FT thermistors are the most excellent products of today's chip thermistors manufacturing.

Part number



Dimensions

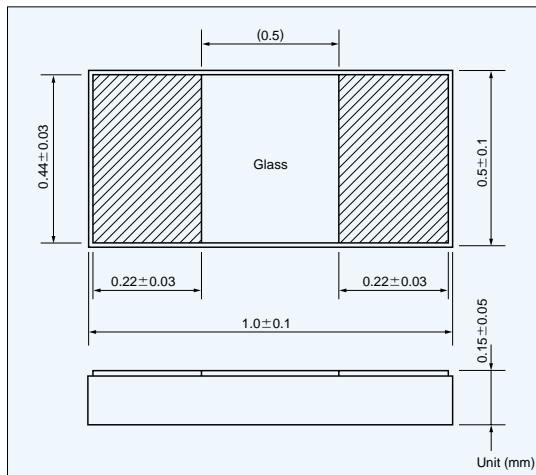

Connect the FTs to the electrodes with using conductive epoxy resins.
The FTs cannot be soldered onto the electrodes.



Specifications

Part No.	R ₂₅ *1	B value*2	Dissipation factor (mW/°C)	Thermal time constant (s)*3	Rated power at 25°C (mW)	Operating temp. range (°C)
103FT	10kΩ ± 5%	3435K ± 1%	0.3	2.0	1.5	-20~125
103FT	10kΩ ± 5%	3370K ± 1%	0.3	2.0	1.5	-20~125
503FT	50kΩ ± 5%	3435K ± 1%	0.3	2.0	1.5	-20~125
503FT	50kΩ ± 5%	3370K ± 1%	0.3	2.0	1.5	-20~125
364FT	364kΩ ± 5%	3370K ± 1%	0.3	2.0	1.5	-20~250

*1 R₂₅: Rated zero-power resistance value at 25°C.

*2 B value: determined by rated zero-power resistance at 25°C and 85°C.

*3 Time when thermistor temperature reaches 63.2% of the temperature difference. The value is measured in the air.

Resistance-Temperature

Temperature (°C)	P/N					Temperature (°C)	P/N				
	103FT		503FT		364FT		103FT		503FT		364FT
	B=3370K	B=3435K	B=3370K	B=3435K	B=3370K		B=3370K	B=3435K	B=3370K	B=3435K	B=3370K
-20	67.26	70.34	336.3	351.9	2447	120					
-10	42.10	43.55	210.5	217.7	1532	125	0.6345	0.6064	3.172	3.029	23.09
0	27.08	27.71	135.4	138.5	985.4	130	0.5671	0.5418	2.836	2.706	20.64
10	17.86	18.11	89.31	90.48	650.0	140					18.50
20	12.07	12.12	60.33	60.58	439.1	150					14.97
25	10.00	10.00	50.00	50.00	363.9	160					12.23
30	8.332	8.299	41.66	41.50	303.2	170					10.07
40	5.871	5.804	29.36	29.03	213.7	180					8.364
50	4.216	4.139	21.08	20.70	153.4	190					7.000
60	3.081	3.006	15.40	15.04	112.1	200					5.901
70	2.288	2.220	11.44	11.11	83.25	210					5.008
80	1.725	1.666	8.623	8.331	62.76	220					4.277
90	1.318	1.269	6.592	6.344	47.98	230					3.676
100	1.021	0.9797	5.105	4.898	37.15	240					3.177
110	0.8003	0.7662	4.002	3.829	29.12	250					2.760
											2.411

Unit (kΩ)

CHIP TYPE THERMISTOR

SMD type chip

Chip thermistors are specially processed, highly reliable thermistors.

They can be face-bonded to act as thermal compensators for ICs and they are manufactured in sizes down to 1 square mm, they can also be used to detect temperature with relatively small time constants.

Part number

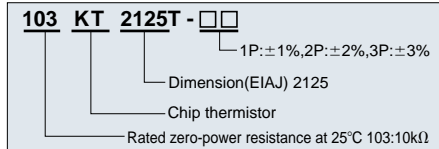

Precautions

- Do not expose the thermistors to high soldering heat for more than specified time. (260°C for not longer than 10s is recommended)

Dimensions

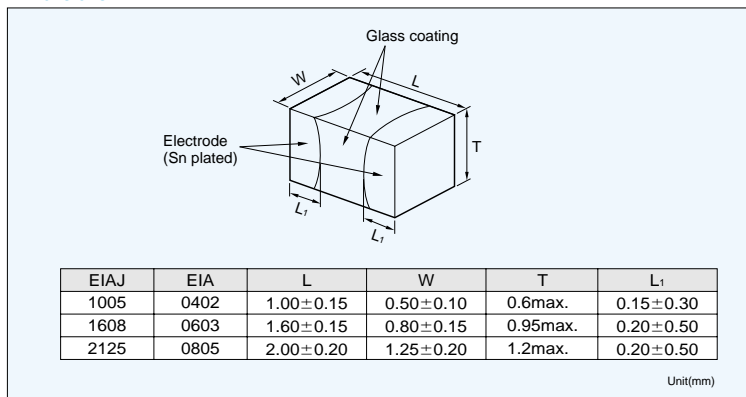

Reflow soldering profile

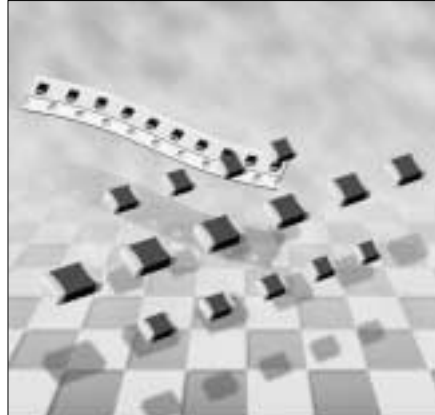
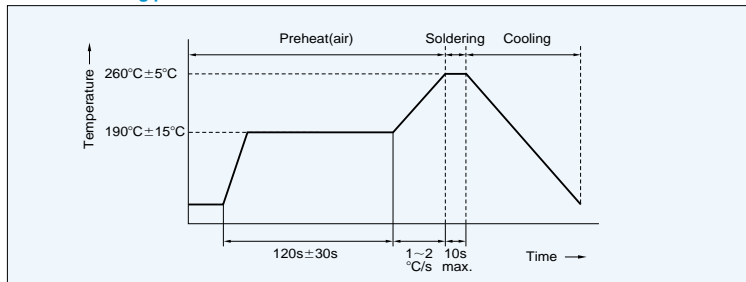

Taping (2125, 1608 type)

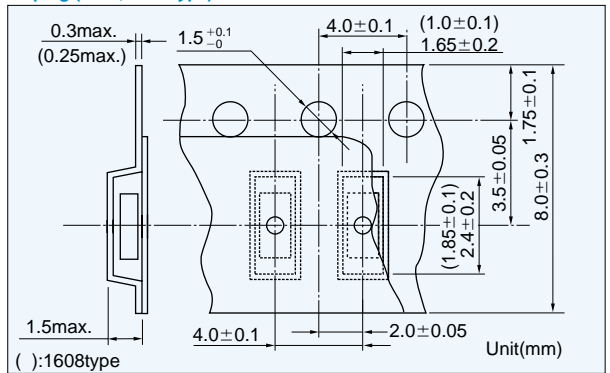

Minimum quantity:4000pcs/reel

(1005 type)

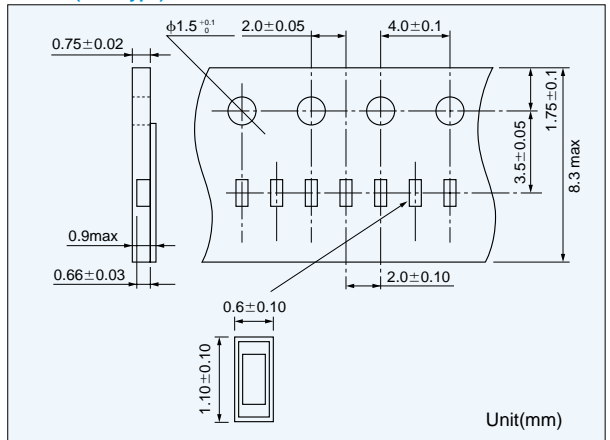

Minimum quantity:10000pcs/reel

Specifications

Part No.	R ₂₅ ⁻¹	B value* ²	Dissipation factor (mW/ °C)	Thermal time constant(s) ^{*3}	Rated power at 25 °C(mW)	Operating temp. range(°C)
103KT2125T	10kΩ	3435K±1%	1.0	7.5	5.0	-40~125
103KT1608T	10kΩ	3435K±1%	0.9	5.0	4.5	-40~125
503KT1608T	50kΩ	4055K±1%	0.9	5.0	4.5	-40~125
104KT1608T	100kΩ	4390K±1%	0.9	5.0	4.5	-40~125
103KT1005T	10kΩ	3435K±1%	0.7	2.2	3.5	-40~125

*1 R₂₅ : Rated zero-power resistance value at 25°C.

*2 B value : determined by rated zero-power resistance at 25°C and 85°C.

*3 Time when thermistor temperature reaches 63.2% of the temperature difference. The value is measured in the air. Other resistance is available, please ask.

HIGH HEAT-RESISTANCE AND HIGH SENSITIVE THERMISTOR

GT THERMISTOR

GT thermistor is combined both superior feature of BT thermistor and ET thermistor as fast response time, high reliability, wide category temperature range, high moisture proof, high accuracy and reasonable price.

GT thermistor is made up of a high quality thermistor element and the lead wire is connected to the thermistor element by alloyed technology, and glass coating for the thermistor element.

Part number

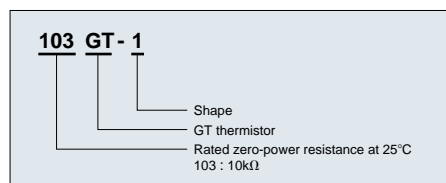

Dimensions

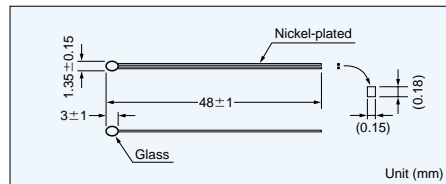

Time constant

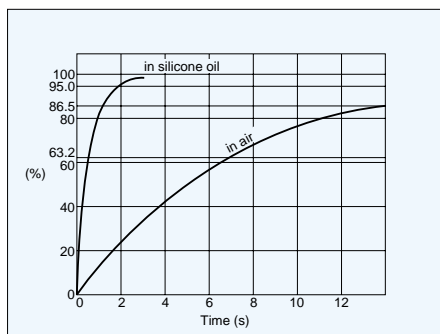

Specifications

Part No.	R ₂₅ *1	B value*2	Dissipation factor (mW/°C)	Thermal time constant(s)*3	Rated power at 25°C(mW)	Operating temp. range(°C)
102GT-1	1.0kΩ±3%	3305K±2%	0.6	7(0.6)	3	-50~200
202GT-1	2.0kΩ±3%	3838K±2%	0.6	7(0.6)	3	-50~300
502GT-1	5.0kΩ±3%	3964K±2%	0.6	7(0.6)	3	-50~300
103GT-1	10.0kΩ±3%	4126K±2%	0.6	7(0.6)	3	-50~300
203GT-1	20.0kΩ±3%	4282K±2%	0.6	7(0.6)	3	-50~300
503GT-1	50.0kΩ±3%	4288K±2%	0.6	7(0.6)	3	-50~300
104GT-1	100.0kΩ±3%	4267K±2%	0.6	7(0.6)	3	-50~300
204GT-1	200.0kΩ±3%	4338K±2%	0.6	7(0.6)	3	-50~300
504GT-1	500.0kΩ±3%	4526K±2%	0.6	7(0.6)	3	-50~300
105GT-1	1000.0kΩ±3%	4608K±2%	0.6	7(0.6)	3	-50~300

*1 R₂₅: Rated zero-power resistance value at 25°C.

*2 B value: determined by rated zero-power resistance at 25°C and 85°C.

*3 Time when thermistor temperature reaches 63.2% of the temperature difference. The value is measured in the air. (silicone oil)

Resistance-Temperature

Temperature (°C)	Type										
	102GT	202GT	502GT	103GT	203GT	503GT	104GT	204GT	504GT	105GT	
-50	32.57	111.3	342.1	825.1	1901	4613	8743				
-40	18.48	61.34	175.4	405.3	909.0	2199	4218	8810			
-30	10.84	33.69	92.54	206.6	453.2	1100	2132	4436	12091		
-20	6.594	18.79	50.44	109.9	236.6	576.2	1127	2329	6268		
-10	4.144	10.82	28.49	60.72	128.3	315.1	620.0	1272	3372	6920	
0	2.675	6.424	16.66	34.82	72.32	178.8	353.7	720.3	1880	3833	
10	1.773	3.939	10.06	20.66	42.24	104.9	208.6	421.8	1083	2190	
20	1.203	2.489	6.264	12.64	25.47	63.52	126.8	254.6	642.3	1289	
30	0.8354	1.618	4.019	7.968	15.82	39.62	79.36	158.2	391.9	780.9	
40	0.5918	1.080	2.651	5.164	10.10	25.37	50.96	100.8	245.4	485.2	
50	0.4273	0.7390	1.792	3.436	6.620	16.64	33.49	65.85	157.5	309.0	
60	0.3141	0.5170	1.239	2.341	4.444	11.16	22.51	43.99	103.3	201.2	
70	0.2347	0.3695	0.8753	1.631	3.050	7.645	15.44	29.98	69.20	133.6	
80	0.1782	0.2693	0.6304	1.159	2.138	5.338	10.80	20.82	47.23	90.53	
90	0.1373	0.1998	0.4624	0.8391	1.527	3.795	7.686	14.71	32.84	62.49	
100	0.1072	0.1507	0.3450	0.6181	1.111	2.742	5.556	10.57	23.22	43.90	
110	0.08483	0.1154	0.2614	0.4626	0.8209	2.014	4.082	7.720	16.68	31.34	
120	0.06787	0.08973	0.2010	0.3514	0.6160	1.501	3.043	5.720	12.15	22.69	
130	0.05488	0.07068	0.1566	0.2706	0.4686	1.133	2.298	4.296	8.976	16.65	
140	0.04483	0.05638	0.1236	0.2111	0.3613	0.8662	1.758	3.269	6.719	12.39	
150	0.03697	0.04550	0.09865	0.1666	0.2820	0.6704	1.360	2.516	5.091	9.330	
160	0.03077	0.03715	0.07967	0.1330	0.2226	0.5247	1.064	1.958	3.903	7.107	
170	0.02584	0.03065	0.06501	0.1073	0.1777	0.4149	0.8414	1.539	3.024	5.472	
180	0.02189	0.02556	0.05358	0.08741	0.1432	0.3314	0.6714	1.222	2.367	4.255	
190	0.01869	0.02151	0.04457	0.07186	0.1166	0.2673	0.5408	0.9796	1.871	3.339	
200	0.01610	0.01826	0.03741	0.05960	0.09573	0.2174	0.4393	0.7919	1.492	2.644	
210			0.03167	0.04986	0.07929	0.1784	0.3597	0.6455	1.200	2.113	
220			0.02703	0.04204	0.06620	0.1475	0.2969	0.5303	0.9726	1.702	
230			0.02324	0.03573	0.05570	0.1230	0.2468	0.4389	0.7946	1.382	
240			0.02014	0.03059	0.04722	0.1032	0.2065	0.3658	0.6539	1.131	
250			0.01759	0.02640	0.04030		0.1740	0.3068	0.5418	0.9323	
260							0.1475	0.2591	0.4519	0.7735	
270							0.1258	0.2201	0.3793	0.6459	
280							0.1079	0.1881	0.3203	0.5424	
290							0.09305	0.1616	0.2720	0.4583	
300							0.08065	0.1396	0.2323	0.3894	

Unit (kΩ)

BT THERMISTOR

The BT thermistor is a small thermal sensing device providing high reliability, stable characteristics and a wide operating range of -50°C to 300°C.

It is used in various applications including medical apparatus, industrial equipment and home electric appliances.

Part number

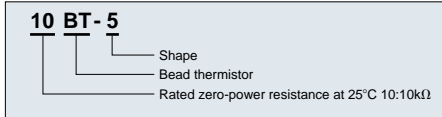

Dimensions

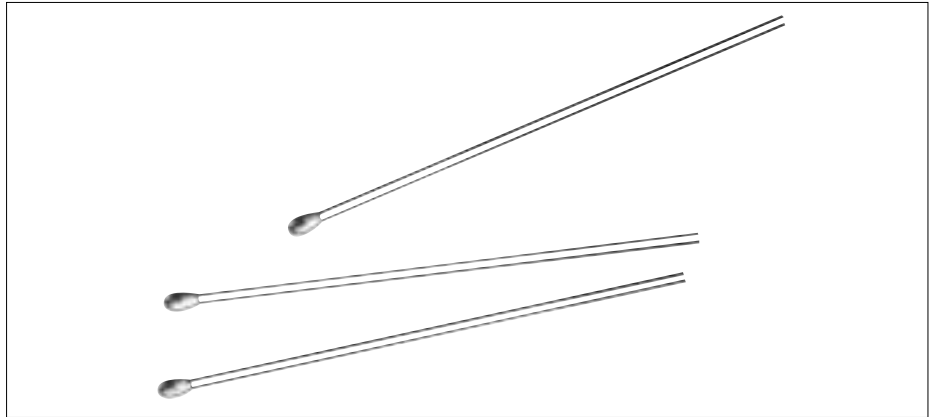
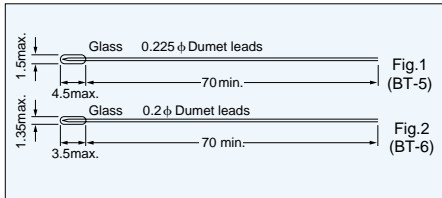

Specifications

Port No.	R ₂₅ ^{*1}	B value ^{*2}	Dissipation factor (mW/°C)	Thermal Time constant(s) ^{*3}	Rated power at 25°C(mW)	Operating temp. range(°C)
1BT-5	1.000kΩ±10%	3,250K±3%	0.5	4~12	2.5	-50~150
2BT-5	2.000kΩ±10%	3,420K±3%	0.5	4~12	2.5	-50~300
5BT-5(6)	5.000kΩ±10%	3,450K±3%	0.5(0.4)	4~12(3~8)	2.5(2)	-50~300
9BT-5(6)	9.000kΩ±10%	3,470K±3%	0.5(0.4)	4~12(3~8)	2.5(2)	-50~150
10BT-5(6)	10.00kΩ±10%	3,250K±3%	0.5(0.4)	4~12(3~8)	2.5(2)	-50~300
20BT-5(6)	20.00kΩ±10%	3,330K±3%	0.5(0.4)	4~12(3~8)	2.5(2)	-50~300
30BT-5(6)	30.00kΩ±10%	3,450K±3%	0.5(0.4)	4~12(3~8)	2.5(2)	-50~300
40BT-5(6)	40.00kΩ±10%	3,550K±3%	0.5(0.4)	4~12(3~8)	2.5(2)	-50~300
100BT-5(6)	100.0kΩ±10%	3,750K±3%	0.5(0.4)	4~12(3~8)	2.5(2)	-50~300
400BT-5(6)	400.0kΩ±10%	4,050K±3%	0.5(0.4)	4~12(3~8)	2.5(2)	-50~300
500BT-5(6)	500.0kΩ±10%	3,760K±3%	0.5(0.4)	4~12(3~8)	2.5(2)	-50~300
1.3MBT-5(6)	1300kΩ±10%	4,380K±3%	0.5(0.4)	4~12(3~8)	2.5(2)	-50~300

*1 R₂₅: Rated zero-power resistance value at 25°C, ±5% are also available.

*2 B value: determined by rated zero-power resistance at 25°C and 85°C.

*3 Time when thermistor temperature reaches 63.2% of the temperature difference. The value is measured in the air

Resistance-Temperature

Temperature (°C)	Type												
	1BT	2BT	5BT	9BT	10BT	20BT	30BT	40BT	100BT	400BT	500BT	1.3MBT	
-50	29.87	70.71		344.8	284.8	686.7			4860				
-40	17.33	40.02		190.3	163.4	383.1			2599	11043			
-30	10.35	23.28		109.1	97.62	222.6			1439	6198			
-20	6.374	13.96	35.44	64.81	60.41	134.2		306.8	827.4	3573			
-10	4.038	8.640	21.84	39.70	38.63	83.61		184.7	491.1	2109			8066
0	2.629	5.513	13.87	25.15	25.45	53.75	83.80	115.0	301.4	1274	1486		4598
10	1.755	3.610	9.057	16.36	17.22	35.53	54.46	73.88	190.1	788.4	945.3		2718
20	1.200	2.421	6.060	10.92	11.92	24.09	36.37	48.77	123.1	498.7	614.7		1652
25	1.000	2.000	5.000	9.000	10.00	20.00	30.00	40.00	100.0	400.0	500.0		1300
30	0.8380	1.661	4.148	7.456	8.434	16.70	24.88	33.00	81.71	322.4	408.9		1029
40	0.5973	1.163	2.898	5.200	6.084	11.81	17.39	22.82	55.39	212.8	277.7		656.0
50	0.4338	0.8311	2.065	3.698	4.456	8.511	12.40	16.10	38.31	143.3	192.1		427.8
60	0.3205	0.6043	1.497	2.677	3.303	6.248	8.990	11.57	27.00	98.24	135.3		284.5
70	0.2407	0.4468	1.104	1.970	2.460	4.658	6.629	8.457	19.38	68.52	96.90		193.0
80	0.1834	0.3357	0.8267	1.473	1.850	3.522	4.962	6.279	14.14	48.50	70.47		133.0
90	0.1417	0.2559	0.6280	1.117	1.405	2.698	3.767	4.730	10.48	34.91	52.00		92.76
100	0.1110	0.1978	0.4836	0.8581	1.078	2.093	2.897	3.611	7.866	25.47	38.90		65.53
110	0.08789	0.1547	0.3771	0.6685	0.8355	1.640	2.255	2.792	5.968	18.83	29.49		46.91
120		0.1224	0.2975	0.5264	0.6540	1.296	1.774	2.182	4.580	14.10	22.63		34.03
130		0.09789	0.2373	0.4191	0.5171	1.027	1.410	1.727	3.551	10.68	17.55		25.02
140		0.07908	0.1913	0.3369	0.4126	0.8190	1.130	1.378	2.782	8.180	13.76		18.59
150		0.06450	0.1556	0.2735	0.3321	0.6581	0.9113	1.107	2.201	6.332	10.90		13.99
160			0.1278		0.2696	0.5327	0.7374	0.8943	1.757	4.957	8.717		10.63
170			0.1058		0.2207	0.4345	0.5997	0.7252	1.416	3.915	7.034		8.163
180			0.08836		0.1818	0.3567	0.4909	0.5915	1.150	3.120	5.722		6.336
190			0.07432		0.1508	0.2947	0.4048	0.4859	0.9418	2.508	4.692		4.965
200			0.06295		0.1258	0.2451	0.3360	0.4018	0.7770	2.032	3.876		3.926
210					0.1056	0.2052	0.2808	0.3344	0.6458	1.658	3.225		3.131
220							0.2360	0.2802	0.5403	1.363	2.702		2.517
230							0.1995	0.2361	0.4551	1.127	2.277		2.039
240							0.1695	0.2000	0.3855	0.9390	1.930		1.663
250							0.1447	0.1704	0.3286	0.7864	1.644		1.366
260							0.1243	0.1458	0.2816	0.6626	1.407		1.129
270							0.1072	0.1255	0.2426	0.5613	1.209		0.9398
280							0.09283	0.1084	0.2100	0.4780	1.041		0.7871
290							0.08078	0.09408	0.1826	0.4091	0.8995		0.6628
300							0.07060	0.08200	0.1595	0.3518	0.7810		0.5612

Unit(kΩ)

CT THERMISTOR

The CT thermistor is a thermal sensor in a DO35 package. Similar to the BT thermistor, it is highly reliable and offers a wide operating range of -50°C to 250°C . It is primarily used in home electric appliances and features a competitive price for full-automated manufacturing system.

Part number

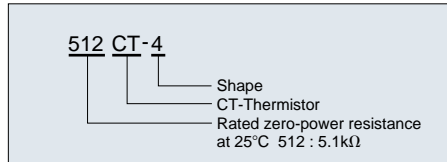

Dimensions

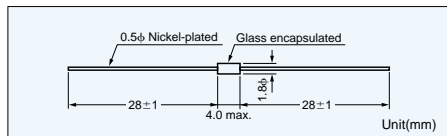

To allow automatic insertion, this product can be taped.



Specifications

Part No.	R ₂₅ * ¹	B value* ²	Dissipation factor (mW/°C)	Thermal time constant (s)* ³	Rated power at 25°C(mW)	Operating temp. range(°C)
252CT-4	2.5kΩ±5%	3670K±2%	2.1	10~20	10.5	-50~250
512CT-4	5.1kΩ±5%	3200K±2%	2.1	10~20	10.5	-50~200
562CT-4	5.6kΩ±5%	3200K±2%	2.1	10~20	10.5	-50~200
912CT-4	9.1kΩ±5%	3270K±2%	2.1	10~20	10.5	-50~250
103CT-4	10.0kΩ±5%	3270K±2%	2.1	10~20	10.5	-50~250
113CT-4	11.0kΩ±5%	3270K±2%	2.1	10~20	10.5	-50~250
203CT-4	20.0kΩ±5%	3410K±2%	2.1	10~20	10.5	-50~250
473CT-4	47.0kΩ±5%	3610K±2%	2.1	10~20	10.5	-50~250
513CT-4	51.0kΩ±5%	3610K±2%	2.1	10~20	10.5	-50~250
563CT-4	56.0kΩ±5%	3610K±2%	2.1	10~20	10.5	-50~250
104CT-4	100.0kΩ±5%	3450K±2%	2.1	10~20	10.5	-50~250
204CT-4	200.0kΩ±5%	3500K±2%	2.1	10~20	10.5	-50~250

*1 R₂₅ : Rated zero-power resistance value at 25°C.

*2 B value : determined by rated zero-power resistance at 25°C and 85°C.

*3 Time when thermistor temperature reaches 63.2% of the temperature difference. The value is measured in the air.

Resistance-Temperature

Temperature (°C)	Type												
	252CT	512CT	562CT	912CT	103CT	113CT	203CT	473CT	513CT	563CT	104CT	204CT	
-50	120.2	137.9	151.4										
-40	65.60	81.02	88.96										
-30	36.48	48.93	53.73	94.62	104.0	114.4							
-20	20.91	30.56	33.55	58.02	63.76	70.13							
-10	12.32	19.65	21.58	36.67	40.29	44.32	81.00						
0	7.516	12.96	14.23	23.82	26.18	28.79	52.63	127.1	138.0	151.5	272.2	553.6	
10	4.738	8.779	9.639	15.92	17.49	19.24	35.15	84.16	91.32	100.3	179.4	362.5	
20	3.074	6.080	6.676	10.91	11.99	13.18	24.01	56.86	61.70	67.75	120.9	242.5	
30	2.045	4.296	4.717	7.626	8.381	9.219	16.74	39.01	42.33	46.47	83.11	165.7	
40	1.393	3.095	3.398	5.441	5.980	6.578	11.88	27.07	29.37	32.25	58.23	115.3	
50	0.9698	2.267	2.489	3.952	4.342	4.777	8.570	19.05	20.67	22.70	41.52	81.91	
60	0.6895	1.687	1.852	2.918	3.206	3.527	6.239	13.58	14.74	16.18	30.14	59.14	
70	0.4993	1.270	1.394	2.184	2.400	2.640	4.581	9.807	10.64	11.68	22.19	43.36	
80	0.3680	0.9650	1.060	1.656	1.820	2.002	3.401	7.187	7.798	8.559	16.57	32.28	
90	0.2757	0.7402	0.8128	1.269	1.394	1.534	2.553	5.327	5.781	6.348	12.52	24.33	
100	0.2098	0.5735	0.6298	0.9787	1.076	1.183	1.937	3.997	4.337	4.762	9.586	18.57	
110	0.1620	0.4493	0.4933	0.7605	0.8357	0.9193	1.489	3.040	3.298	3.622	7.434	14.36	
120	0.1267	0.3559	0.3908	0.5952	0.6540	0.7194	1.156	2.337	2.535	2.784	5.827	11.24	
130	0.1003	0.2847	0.3126	0.4702	0.5168	0.5684	0.9075	1.815	1.969	2.162	4.619	8.900	
140	0.08028	0.2298	0.2524	0.3750	0.4121	0.4533	0.7191	1.425	1.546	1.698	3.694	7.108	
150	0.06494	0.1870	0.2053	0.3016	0.3314	0.3646	0.5752	1.129	1.226	1.346	2.982	5.732	
160	0.05302	0.1534	0.1684	0.2444	0.2686	0.2955	0.4638	0.9031	0.9799	1.076	2.428	4.666	
170	0.04369	0.1267	0.1391	0.1996	0.2193	0.2413	0.3771	0.7280	0.7899	0.8674	1.992	3.829	
180	0.03630	0.1055	0.1158	0.1643	0.1805	0.1986	0.3091	0.5919	0.6422	0.7052	1.647	3.168	
190	0.03039	0.08833	0.09699	0.1362	0.1496	0.1646	0.2552	0.4849	0.5261	0.5777	1.371	2.641	
200	0.02562	0.07445	0.08175	0.1136	0.1249	0.1374	0.2122	0.4000	0.4341	0.4766	1.149	2.216	
210				0.09541	0.1049	0.1153	0.1777	0.3324	0.3607	0.3961	0.9697	1.871	
220				0.08063	0.08860	0.09746	0.1497	0.2780	0.3016	0.3312	0.8235	1.591	
230				0.06853	0.07531	0.08284	0.1269	0.2339	0.2538	0.2787	0.7033	1.360	
240				0.05857	0.06436	0.07080	0.1082	0.1979	0.2147	0.2358	0.6038	1.169	
250				0.05031	0.05529	0.06082	0.09271	0.1683	0.1827	0.2006	0.5208	1.010	

Unit(kΩ)

TEMPERATURE COMPENSATION D THERMISTOR

The D thermistor, based on resistance changes, is used in transistor, coil and other temperature compensating circuits found in TV's, radio, etc.

Part number



Dimensions

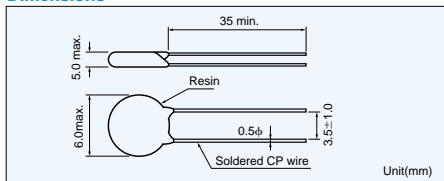

Taping



Specifications

Part No.	R25*1	B value*2	Dissipation factor (mW/°C)	Thermal time constant(s)*3	Rated power at 25°C(mW)	Operating temp. range(°C)
50D-5	50.0Ω±15%	3250K±5%	3.5	13	297	-40~+110
80D-5	80.0Ω±15%	3300K±5%	3.5	13	297	-40~+110
100D-5	100.0Ω±15%	3300K±5%	3.5	13	297	-40~+110
200D-5	200.0Ω±15%	3400K±5%	3.5	13	297	-40~+110
250D-5	250.0Ω±15%	3450K±5%	3.5	13	297	-40~+110
300D-5	300.0Ω±15%	3500K±5%	3.5	13	297	-40~+110
360D-5	360.0Ω±15%	3550K±5%	3.5	13	297	-40~+110
500D-5	500.0Ω±15%	3650K±5%	3.5	13	297	-40~+110
800D-5	800.0Ω±15%	3850K±5%	3.5	13	297	-40~+110
1KD-5	1.0kΩ±15%	3950K±5%	3.5	13	297	-40~+110
1.5KD-5	1.5kΩ±15%	3950K±5%	3.5	13	297	-40~+110
2KD-5	2.0kΩ±15%	4000K±5%	3.5	13	297	-40~+110
5KD-5	5.0kΩ±15%	4100K±5%	3.5	13	297	-40~+110
8KD-5	8.0kΩ±15%	4200K±5%	3.5	13	297	-40~+110
10KD-5	10.0kΩ±15%	4200K±5%	3.5	13	297	-40~+110
15KD-5	15.0kΩ±15%	4250K±5%	3.5	13	297	-40~+110
20KD-5	20.0kΩ±15%	4300K±5%	3.5	13	297	-40~+110
25KD-5	25.0kΩ±15%	4300K±5%	3.5	13	297	-40~+110
50KD-5	50.0kΩ±15%	4650K±5%	3.5	13	297	-40~+110
100KD-5	100.0kΩ±15%	4850K±5%	3.5	13	297	-40~+110

*1 R25 : Rated zero-power resistance value at 25°C, ±10% are also available.

*2 B value : determined by rated zero-power resistance at 25°C and 85°C.

*3 Time when thermistor temperature reaches 63.2% of the temperature difference. The value is measured in the air.

FROST DETECTING SENSOR FD SENSOR

The FD Sensor has been developed to detect the level of accumulated frost on the evaporator in frost-free systems, such as those found in domestic fridge-freezers. It helps to eliminate unnecessary defrost cycles and also increases the energy efficiency of the system.

1. Application

Any frost-free system found in domestic and commercial fridge-freezers, vending machines, ice-makers, etc.

2. Features

Simple detecting principle
Highly sensitive
Ease of assembly
Replaces less-efficient conventional sensors

3. Dimensions

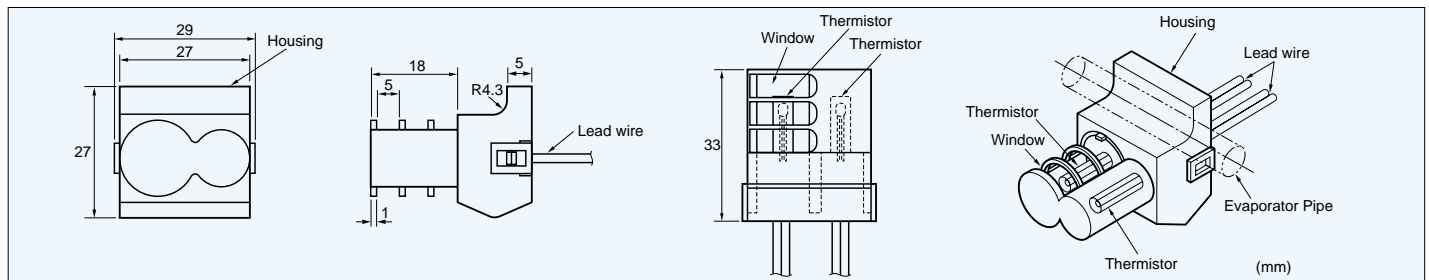

4. Findings from studies carried on the FD Sensor

Study (A)

A 12% of energy saving in a 420 liter domestic frost-free fridge-freezer was found by one of the major Japanese refrigerator manufacturers by the following test procedures.

Test Procedure

The power consumption measurement was carried out in accordance with "JIS C9607 power consumption test, item B (≡ISO8561). The test procedure was extended to one week to determine the full advantage of the defrost system using the FD Sensor.

	Power Consumption	No. of defrost cycle completed
Conventional Fixedtime defrost system	74.16KK Whr/month	9 times/week
Defeost system with FD Sensor	65.6KK Whr/month	Once/week
Improved efficiency		12%

Study (B)

Evaluation of the FD Sensor in a 130 liter domestic frost-free fridge-freezer was made by another Japanese refrigerator manufacturer. They obtained an energy saving of over 10% using the same test method as in 5(A) above but including the opening and closing the fridge-freezers doors.

Study (C)

Evaluation of the FD Sensor in a 400 liter domestic frost-free fridge-freezer made by a Japanese refrigerator manufacturer shows an energy saving of over 10%. Measurement of this energy saving was made using the test method specified as in 5(A) above.

5. Specifications

FD Sensor

- 1) Environmental Temperature range : $-40^{\circ}\text{C} \sim +80^{\circ}\text{C}$
- 2) Operating temperature range : $-40^{\circ}\text{C} \sim -5^{\circ}\text{C}$
- 3) Sensitivity : $4^{\circ}\text{C} \sim 12^{\circ}\text{C}$

(Difference in temperature measured by both NTC Thermistors when no frost is recognized.)

NTC Thermistor characteristics(only for reference)

- 1) Nominal Zero power resistance : $R_{25}=10\text{k}\Omega \pm 3\%$
- 2) Rated B value : $B_{25/85}=3435\text{K} \pm 1\%$
- 3) Absolute difference between the two NTCs : $\pm 0.2\%$ or $\pm 0.05^{\circ}\text{C}$ at 25°C

6. Reliability

Climatic test properties

Test	Test Conditions	Criteria
Dry heat	In air at 100°C for 1,000hr.	Deviation of resistance at 25°C from the original value after test within $\pm 2\%$ and deviation of B value(B25/85) from the original value after test is within $\pm 1\%$.
Cold	In air at -55°C for 1,000hr.	
Damp heat	95% RH at 40°C for 1,000hr.	
Thermal shock	Between -40°C and $+75^{\circ}\text{C}$ for 10,000 cycles.	

7. Mechanical properties

Test	Test Conditions	Criteria
Free Fall	3 natural drops from 75 cm high	Deviation of resistance at 25°C from the original value after test within $\pm 2\%$ and deviation of B value(B25/85) from the original value after test is within $\pm 1\%$.
Robustness of termination	40 N for 10 seconds	
Vibration	JIS C2571 Item A	

TEMPERATURE SENSOR

The TEMPERATURE SENSOR is assembled one with various parts and thermistor devices according to the required applications. Its electric characteristics are the same as those of thermistor devices. Variable type of sensor can be utilized for detecting or controlling temperature because its operating temperature range is wide from -50 to $+300^{\circ}\text{C}$. Standard TEMPERATURE SENSOR is available in accordance with the applications such as measurements of liquid, atmosphere and surface temperature.

External dimensions

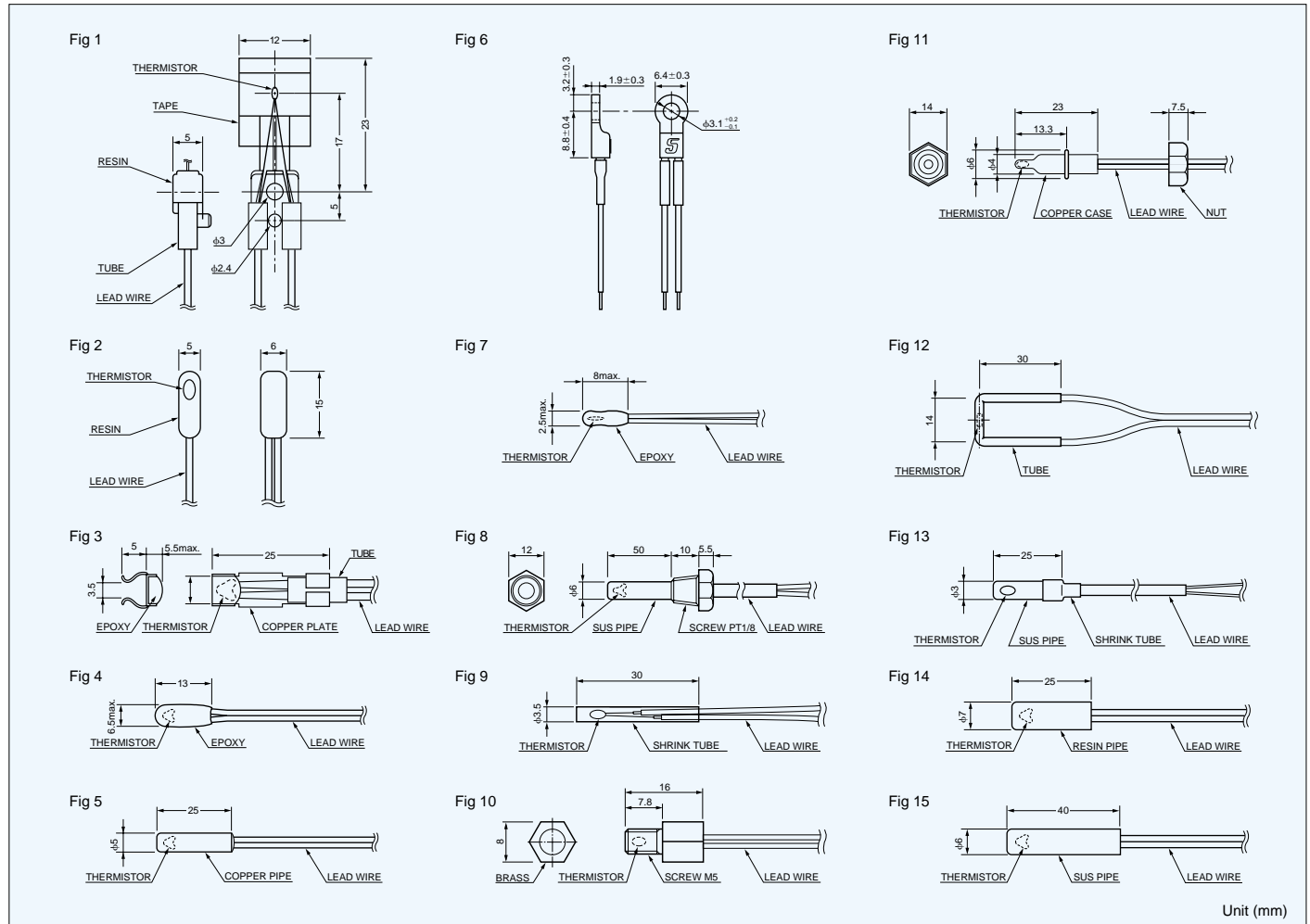

Specifications

Fig	Thermal Time constant(s)			Dissipation factor mW/°C	Operating temperature range	Application	Thermistor
	Air	Water	Heater				
1	—	—	3	1.2	$-30^{\circ}\text{C}\sim 230^{\circ}\text{C}$	Surface temp. sensor for OA equipment.	BT
2	75	—	—	3	$-30^{\circ}\text{C}\sim 105^{\circ}\text{C}$	Air temp. sensor for general use.	AT
3	40	—	—	4	$-30^{\circ}\text{C}\sim 105^{\circ}\text{C}$	Surface temp. sensor for general use.	AT
4	70	—	—	5	$-30^{\circ}\text{C}\sim 110^{\circ}\text{C}$	Air temp. sensor for air conditioner.	AT(ET)
5	130	—	—	4	$-30^{\circ}\text{C}\sim 110^{\circ}\text{C}$	Air temp. sensor for air conditioner.	AT(ET)
6	65	—	—	3	$-30^{\circ}\text{C}\sim 105^{\circ}\text{C}$	Surface temp. sensor for general use.	AT
7	10	—	—	2	$-30^{\circ}\text{C}\sim 90^{\circ}\text{C}$	Surface temp. sensor for rechargeable battery.	AT
8	—	5	—	4.5	$-30^{\circ}\text{C}\sim 105^{\circ}\text{C}$	Water (Oil)temp. sensor for general use.	AT(ET, GT)
9	—	3	—	1.1	$-50^{\circ}\text{C}\sim 200^{\circ}\text{C}$	For general use.	BT
10	70	—	—	5	$-50^{\circ}\text{C}\sim 170^{\circ}\text{C}$	Inner temp. sensor for general use.	GT(AT, ET)
11	—	1.0	—	2.7	$-30^{\circ}\text{C}\sim 100^{\circ}\text{C}$	Fast response water temp. sensor	ET
12	30	—	—	3	$-50^{\circ}\text{C}\sim 205^{\circ}\text{C}$	Surface temp. sensor for cooker.	CT
13	85	—	—	1.5	$-30^{\circ}\text{C}\sim 100^{\circ}\text{C}$	Air temp. sensor for general use.	ET
14	130	—	—	2.6	$-30^{\circ}\text{C}\sim 105^{\circ}\text{C}$	For general use.	AT(ET)
15	260	—	—	2.6	$-30^{\circ}\text{C}\sim 105^{\circ}\text{C}$	For general use.	AT(ET)

POWER THERMISTOR

The POWER THERMISTOR is a device for suppressing inrush current to an electric circuit. Circuits including electric bulbs or capacitors induce an inrush current more than 100 times the normal current when the circuit switch is turned on. The POWER THERMISTOR in the circuits protects electric equipments from being damaged by limiting the inrush current.

MARK II is a NEW POWER THERMISTOR featuring smaller size and larger energy capacity to meet severe requirements in inrush current suppression. There is the tendency of miniaturization in low power switching power supply, and MARK II is effectively applicable for the needs, though the comparatively larger sized fixed resistors (ceramic coat) are used now.



Application

The power thermistor will suppress inrush current which is caused by a capacitor, filament for a bulb, inverter for fluorescent lamp, a heater and etc., also will control fan motor speed of cooler for electric circuit. Especially MARK II was developed to use for power supply of TV, VCR instead of cement resistor.

How to use the power thermistor

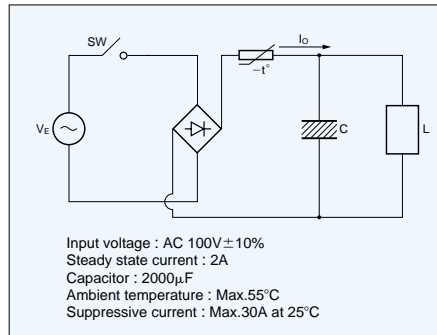

The most suitable power thermistor for the above circuit is required to fulfill the following terms and conditions.

1. The permissible current at ambient temperature of 55°C should be over 2A.
2. The thermistor resistance for suppressive current which becomes below 30A should be over 4.2 ohm from the under-mentioned formula.

$$\frac{\sqrt{2} V_E \times 1.1}{R_C + R_{25}} \leq 30$$

R_C : Internal resistance value in the circuit is 1 ohm (100V/100A)

R_{25} : Rated zero-power resistance at 25°C

3. Max. capacitance shall be over 2000μF at AC 100V.

Accordingly, suitable thermistors are 6D-22, 5D-18 and 8D-18, and if we consider in the points of small time constant which means a small size and large effect for suppressive current which means large rated zero-power resistance, 8D-18 is the most suitable one.

Use the following circuit in the power supply for 100V and 200V.

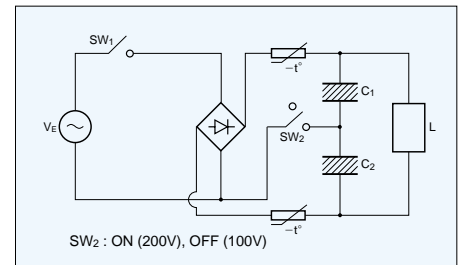

Thermal time constant

If ambient temperature of a thermistor is changed to T₁ from T₂ suddenly, temperature of the thermistor changes slowly. The time constant means the time when temperature of the thermistor reaches 63% of the temperature difference.

Residual resistance

If current is flowed through a thermistor, any heat will be generated in the thermistor by which its resistance will be decreased, however, a decrease of a resistance will be stabilized at a saturation resistance value which is determined by impressed electric power and a dissipation constant. The residual resistance value means maximum saturation resistance value when the maximum permissible current is flowed through the thermistor.

Temperature coefficient

The temperature coefficient of a thermistor is expressed by the following equation ;

$$-\frac{B}{T^2} \text{ (%/}^\circ\text{C)}$$

Dissipation factor

If small voltage is applied to a thermistor, small current will flow which produce enough heat in the thermistor. Dissipation factor is electric power which make 1°C raise by heat in a thermistor.

$$\delta = \frac{P}{\Delta t} \text{ (mW/}^\circ\text{C)}$$

P is applied electric power.
Δt is rised temperature of the thermistor.

Maximum permissible current

If the maximum permissible current flows to a thermistor at 25°C, temperature of the thermistor rises to 200°C, (160°C). When ambient temperature is above 25°C, the maximum permissible current shall be over reduced as the maximum permissible current reduction curve.

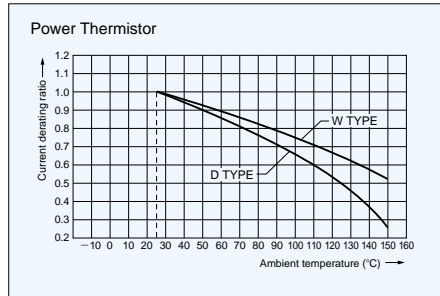
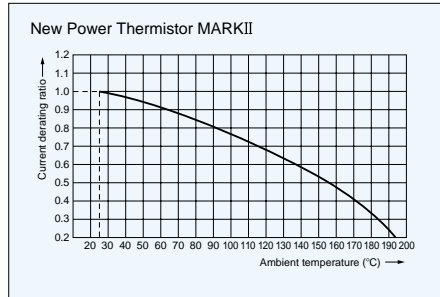

Reliability tests

MARKII

Dry heat test

Test sample is exposed in air at 200°C for 1,000 hours. ΔR₂₅/R₂₅ ≤ ±20%

Damp heat test

Test sample is exposed in atmosphere of 95%RH at 40°C for 1,000 hours. ΔR₂₅/R₂₅ ≤ ±10%

Load test

Test sample is applied the maximum rating current in air at 25°C for 1,000 hours. ΔR₂₅/R₂₅ ≤ ±20%

Change of temperature

Test sample is given 10 times of the following temperature cycle,
→ -40°C for 30 minutes → room temperature for 5 minutes →
→ 200°C for 30 minutes → room temperature for 5 minutes.
ΔR₂₅/R₂₅ ≤ ±10%

POWER THERMISTOR

Dry heat test

Test sample is exposed in air at 160°C for 1,000 hours. ΔR₂₅/R₂₅ ≤ ±10%

Damp heat test

Test sample is exposed in atmosphere of 95%RH at 40°C for 1,000 hours. ΔR₂₅/R₂₅ ≤ ±10%

Load test

Test sample is applied the maximum rating current in air at 25°C for 1,000 hours. ΔR₂₅/R₂₅ ≤ ±10%

Change of temperature

Test sample is given 10 times of the following temperature cycle,
→ -30°C for 30 minutes → room temperature for 5 minutes →
→ 160°C for 30 minutes → room temperature for 5 minutes.
ΔR₂₅/R₂₅ ≤ ±10%

Resistance-temperature characteristics

The theoretical characteristics of a thermistor is expressed by following equation.

$$R_1 = R_2 \exp \left\{ B \left(\frac{1}{T_1} - \frac{1}{T_2} \right) \right\}$$

R₁ is the zero-power resistance at absolute temperature T₁
R₂ is the zero-power resistance at absolute temperature T₂

B is constant which depends on the material used to make the thermistor. Unless otherwise specified, all values of B are determined from measurements made at 25°C and 85°C.





Specifications (Disk type)

Part No.	R ₂₅ ^{*1} (Ω)	B value ^{*2} B _{25/85} (K)	Maximum energy J (W·s)	Maximum rating current at 25°C (A)	Residual resistance ^{*3} (Ω)	Dissipation factor (mW/°C)	Thermal time constant ^{*4} (s)	Rating temp (°C)	Maximum capacitance (μF)			
									AC100V	AC120V	AC220V	AC240V
3D-22	3±15%	3250±5%	40.0	5.4	0.137	29.8	130	-30~160	8,500	5,900	1,700	1,470
4D-22	4±15%	3250±5%	50.0	4.7	0.182	30.7	160	-30~160	11,000	7,600	2,200	1,900
6D-22	6±15%	3250±5%	80.0	3.9	0.274	32.4	220	-30~160	17,000	11,800	3,500	2,950
4D-18	4±15%	3250±5%	9.0	4.1	0.182	22.8	100	-30~160	2,000	1,350	410	340
5D-18	5±15%	3250±5%	11.0	3.8	0.228	24.6	120	-30~160	2,500	1,700	510	430
8D-18	8±15%	3250±5%	18.0	3.1	0.365	27.2	150	-30~160	4,100	2,800	840	710
10D-18	10±15%	3250±5%	22.0	2.8	0.456	28.2	150	-30~160	5,000	3,400	1,030	860
5D-13	5±15%	3250±5%	4.0	3.4	0.228	20.1	55	-30~160	900	620	180	150
8D-13	8±15%	3250±5%	6.0	2.7	0.365	20.3	65	-30~160	1,400	970	280	240
16D-13	16±15%	3250±5%	12.0	1.9	0.730	21.4	105	-30~160	2,800	1,900	570	480
5D-11	5±15%	3250±5%	4.0	3.3	0.228	19.0	50	-30~160	900	620	180	150
8D-11	8±15%	3250±5%	6.0	2.6	0.365	19.8	70	-30~160	1,400	970	280	240
10D-11	10±15%	3250±5%	7.0	2.4	0.456	20.1	75	-30~160	1,800	1,250	370	310
10D-9	10±15%	3250±5%	2.0	2.2	0.456	17.2	40	-30~160	510	350	100	80
16D-9	16±15%	3250±5%	4.0	1.7	0.730	17.4	50	-30~160	820	560	160	140
22D-7	22±15%	3250±5%	1.0	1.4	1.003	15.7	30	-30~160	310	210	60	50

Specifications (Washer type)

Part No.	R ₂₅ ^{*1} (Ω)	B value ^{*2} B _{25/85} (K)	Maximum energy J (W·s)	Maximum rating current at 25°C (A)	Residual resistance ^{*3} (Ω)	Dissipation factor (mW/°C)	Thermal time constant ^{*4} (s)	Rating temp (°C)	Maximum capacitance (μF)			
									AC100V	AC120V	AC220V	AC240V
6W-22	6.0±15%	3250±5%	80	6.1	0.153	34.0	220	-30~200	17,000	11,800	3,500	2,950
4W-25	4.0±15%	3250±5%	50	7.8	0.102	36.2	160	-30~200	11,000	7,600	2,200	1,900

*1 R₂₅: Rated zero-power resistance value at 25°C.

*2 B value: determined by rated zero-power resistance at 25°C and 85°C.

*3 Residual resistance is the maximum value when maximum rating current is applied.

*4 Time when thermistor temperature reaches 63.2% of the temperature difference. The value is measured in the air.

Part number

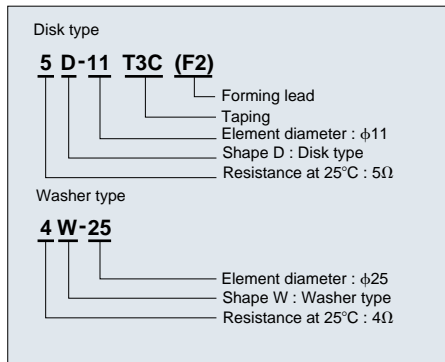

Dimensions

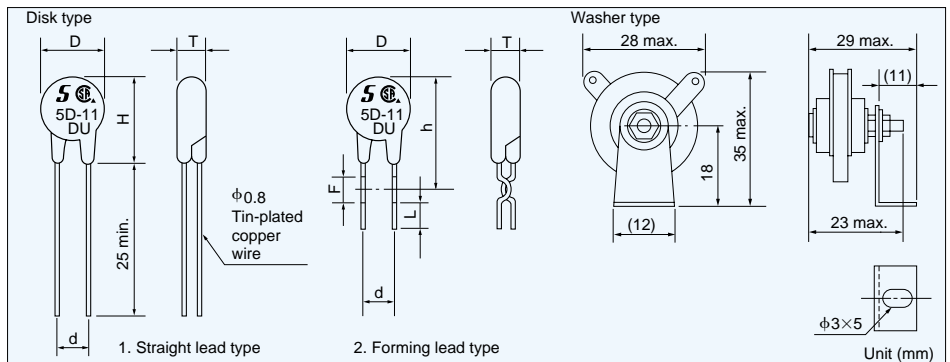

●UL approved (Disk type)

File No. E92669

Thermistor type device

●Canadian Standards (Disk type)

File No. CA97673-1

Class 7950 30 NTC Thermistor

	D	T	H	h	F	L	d
D-7	9.5max.	5max.	13max.	15max.	3±0.2	3.5±0.5	6±1
D-9	11max.	6max.	15max.	17max.			7.5±1
D-11	14max.		18max.	20max.			
D-13	16max.	8max.	20max.	22max.			10±1
D-18	21max.	9max.	26max.	28max.			
D-22	25max.	8max.	30max.	32max.			

Unit (mm)

Taping

	P	P ₀	P ₁	W	W ₀	W ₁	W ₂	H ₁	L	F ₁	φD ₀	t	t ₁	Δh
D-7	15±1	15±0.3	3.75±0.7	18 ^{+1.0} _{-0.5}	5min.	9±0.5	3max.	16±0.5	1max.	7.5±0.5	4±0.3	0.6±0.3	1.6max.	0±2
D-9														
D-11														
D-13	30±1													

Unit (mm)

Taping

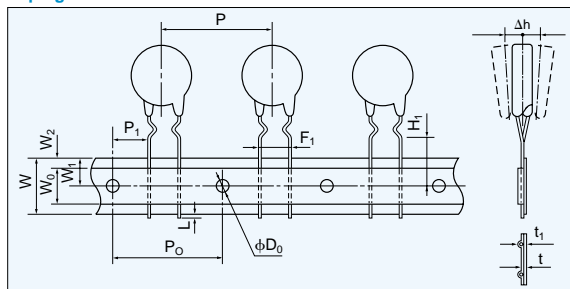

Specifications (Disk type)

Part No.	R ₂₅ ^{*1} (Ω)	B value ^{*2} B _{25/85} (K)	Maximum energy J (W·s)	Maximum rating current at 25°C (A)	Residual resistance (Ω)	Dissipation factor (mW/°C)	Thermal time constant (s)	Rating temp (°C)	Maximum capacitance (μF)			
									AC100V	AC120V	AC220V	AC240V
M5R107	5.1±10%	2900±5%	2.0	4.6	0.18	17.0	20	-40~200	400	270	80	60
M8R207	8.2±10%	2900±5%	2.8	3.6	0.30	17.2	25	-40~200	560	380	110	90
M10007	10.0±10%	2900±5%	3.4	3.3	0.36	17.2	30	-40~200	680	470	140	110
M12007	12.0±10%	3150±5%	3.6	3.6	0.24	17.5	25	-40~200	560	380	110	90
M16007	16.0±10%	3150±5%	4.0	3.1	0.43	17.8	30	-40~200	800	550	160	130
M22007	22.0±10%	3150±5%	4.8	2.6	0.59	18.0	40	-40~200	960	660	190	160
M2R210	2.2±10%	2900±5%	8.2	7.4	0.08	18.9	40	-40~200	1,640	1,130	330	280
M3R010	3.0±10%	2900±5%	8.6	6.4	0.11	19.2	45	-40~200	1,720	1,190	350	290
M3R910	3.9±10%	2900±5%	8.0	5.6	0.11	19.5	45	-40~200	1,880	1,300	380	320
M5R110	5.1±10%	3150±5%	7.2	5.7	0.14	19.2	40	-40~200	1,440	1,000	290	250
M8R210	8.2±10%	3150±5%	7.8	4.5	0.22	19.9	50	-40~200	1,560	1,080	320	270
M10010	10.0±10%	3150±5%	8.2	4.1	0.27	20.1	60	-40~200	1,640	1,130	330	280
M1R014	1.0±10%	2900±5%	18.0	11.9	0.04	22.0	65	-40~200	3,720	2,580	760	640
M2R014	2.0±10%	2900±5%	21.0	8.6	0.07	23.4	90	-40~200	4,200	2,900	860	720
M3R014	3.0±10%	3150±5%	15.0	8.3	0.08	23.6	80	-40~200	3,080	2,130	630	530
M3R914	3.9±10%	3150±5%	17.0	7.4	0.08	24.5	95	-40~200	3,400	2,360	700	590
M5R114	5.1±10%	3150±5%	18.0	6.5	0.14	24.7	110	-40~200	3,600	2,500	740	620

*1 R₂₅: Rated zero-power resistance value at 25°C.

*2 B value: determined by rated zero-power resistance at 25°C and 85°C.

*3 Residual resistance is the maximum value when maximum rating current is applied.

*4 Time when thermistor temperature reaches 63.2% of the temperature difference. The value is measured in the air.

Part number

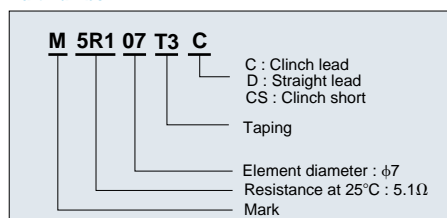

●UL approved

File No. E92669

Thermistor type devices

Dimensions

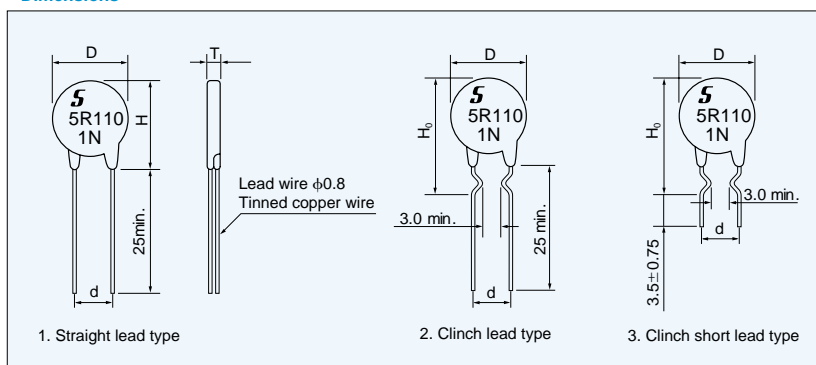

Taping

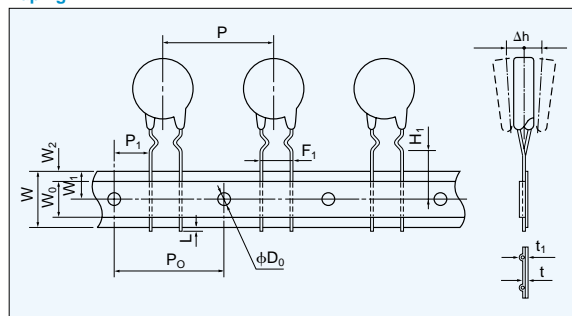

	D	T	H	H ₀	d
M...07	9.5max.	6max.	12max.	15max.	7.5±1
M...10	13max.		17max.	19.5max.	
M...14	17max.		20.5max.	22.5max.	

Taping

	P	P ₀	P ₁	W	W ₀	W ₁	W ₂	H ₁	L	F ₁	φD ₀	t	t ₁	Δh
M...07	15±1	15±0.3	3.75±0.7	18 ^{+1.0} _{-0.5}	5min.	9±0.5	3max.	16±0.5	1max.	7.5±0.5	4±0.2	0.6±0.3	1.5max.	0±2
M...10	30±1													
M...14	30±1													

Specifications (Disk type)

Part No.	R ₂₅ ^{*1} (Ω)	Maximum rating current at 25°C (A)	Residual resistance ^{*2} (Ω)	Dissipation factor (mW/°C)	Thermal time constant ^{*3} (s)	Rating temp (°C)	Maximum capacitance at AC220V (μF)
5D2-05	5	1.7	0.610	14	25	-40~160	36
8D2-05	8	1.3	0.970	14	27	-40~160	39
10D2-05	10	1.2	1.210	14	31	-40~160	39
12D2-05	12	1.4	0.860	14	26	-40~160	49
16D2-05	16	1.2	1.150	14	30	-40~160	57
3D2-07	3	2.4	0.370	30	35	-40~160	42
5D2-07	5	3.0	0.352	30	35	-40~160	80
8D2-07	8	2.0	0.562	30	41	-40~160	110
10D2-07	10	2.0	0.706	30	45	-40~160	140
12D2-07	12	1.7	0.780	30	41	-40~160	80
16D2-07	16	2.0	1.125	30	45	-40~160	160
22D2-07	22	1.0	1.547	30	50	-40~160	190
2D2-10	2	5.0	0.107	32	50	-40~160	330
3D2-10	3	4.0	0.160	32	53	-40~160	350
5D2-10	5	4.0	0.267	32	53	-40~160	290
8D2-10	8	3.0	0.427	32	70	-40~160	320
10D2-10	10	3.0	0.533	32	75	-40~160	330
12D2-10	12	1.8	0.780	32	53	-40~160	173
16D2-10	16	1.6	0.940	32	70	-40~160	173
2D2-14	2	5.0	0.107	36	90	-40~160	860
3D2-14	3	5.0	0.160	36	80	-40~160	630
4D2-14	4	5.0	0.213	36	95	-40~160	700
5D2-14	5	4.0	0.267	36	110	-40~160	740
8D2-14	8	2.5	0.470	36	80	-40~160	289
10D2-14	10	2.2	0.590	36	95	-40~160	371
12D2-14	12	2.0	0.710	36	105	-40~160	454
16D2-14	16	1.8	0.940	36	115	-40~160	578

*1 R₂₅ : Rated zero-power resistance value at 25°C.

*2 Residual resistance is the maximum value when maximum rating current is applied.

*3 Time when thermistor temperature reaches 63.2% of the temperature difference. The value is measured in the air.

Part number

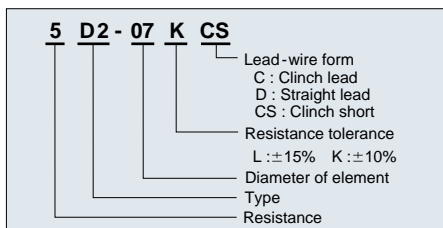

●UL approved
 File No. E92669
 Thermistor type devices

Dimensions

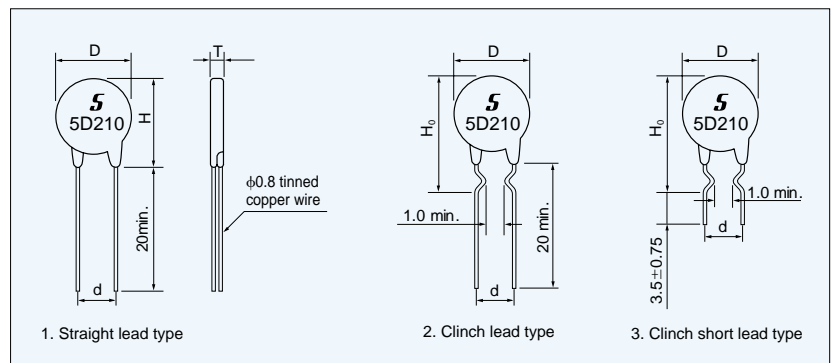

	D	T	H	H ₀	d
D2-05	7±2	6.8max.	9±2	14.0max.	5.0±1
D2-07	9±2		11±2	15.0max.	5.0±1
D2-10	11±2		15±2	19.5max.	5.0±1
D2-14	15±2		19±2	22.5max.	7.5±1

TRANSIENT VOLTAGE SUPPRESSOR

VRD

VRD is a transient voltage suppressor used for protecting electric circuits from surge voltage and thus preventing breakdown.

VRD has superior surge suppression characteristics, such as extremely fast response time, very low clamping voltage, and high surge capacity. Unlike metal oxide varistors, VRD does not have characteristics to change with surge variations within the rated capacity. This feature comprises another superior characteristics of the VRD as a transient voltage suppressors.

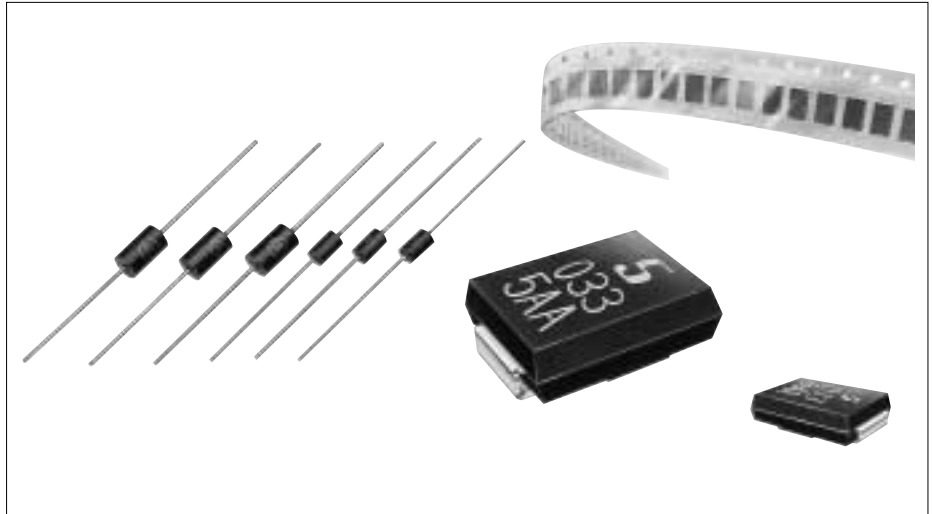

Electrical characteristics

Figure 1 shows the electrical characteristics. Bipolar type has almost symmetrical breakdown Voltage (V_B) The reverse breakdown voltage of the ZD type is 200 Volts or more at 10 μ A DC.



Fig 1

Taping

One of standard taping is as shown in Figure.



Fig 2

Surge capability

Allowable surge capability (P_m) is determined by the following equation:

$$P_m = I_p \times V_c$$

I_p : Peak current

V_c : Maximum clamping voltage

The allowable surge capability (peak pulse power) of VRD is shown in following Figure 3 and the surge capability derating characteristics are shown in Figure 6.

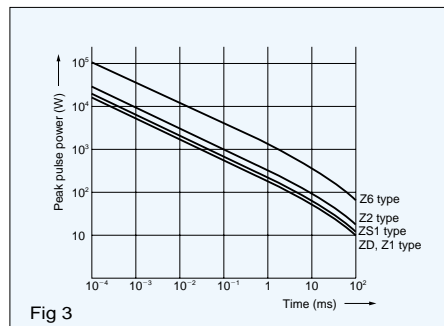

Fig 3

Surge waveform

There are many types of surge waveform depending on the source of the surge. For the VRD surge suppression characteristics test, the EXP waveform shown below is used. The EXP waveform is shown as t_a/t_b depending on the time width, however 10/1000 waveform is used as the standard test waveform.

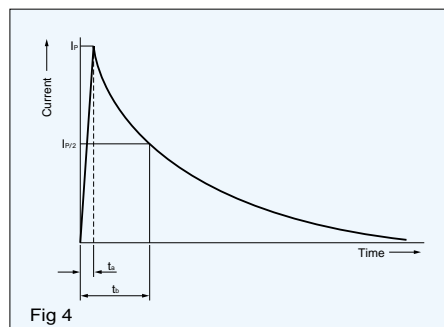

Fig 4

Surge suppression characteristics

When EXP waveform is applied to the circuit below, the surge suppression waveform shown in the figure 5 can be observed.

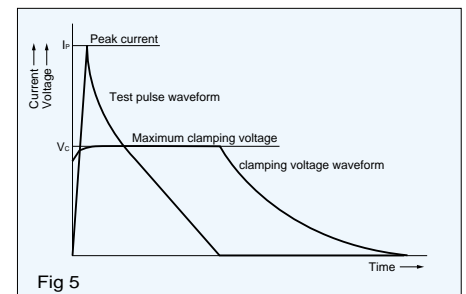

Fig 5

Power derating

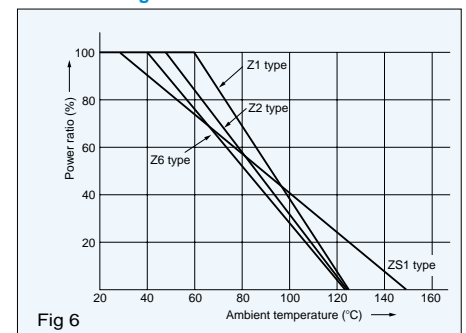
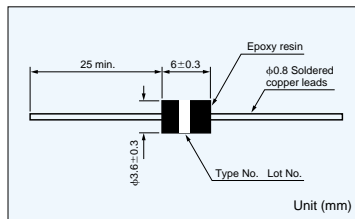

Fig 6

Z1 type VRD has bipolar electrical characteristics.

Maximum ratings
 Peak pulse power: 250 W (10/1000 μ s)
 3.00 kW (8/20 μ s)
 Steady state power dissipation: 500 mW
 Operating and storage temperature
 : -40°C to 125°C

Symbol mark



Bi-polar type	Stand-off voltage V_s V	Maximum leakage current I_L μ A	Breakdown voltage V_B V	Test current I_T mA	Maximum clamping voltage & Maximum peak pulse current				Max. temp. coef. %/°C	Capacitance (TYP) pF
					10/1000 μ s		8/20 μ s			
					V_C V	I_P A	V_C V	I_P A		
Z1015	12.1	5	13.5-16.5	1	22.0	11.3	28.4	106.	0.075	450
Z1018	14.5	5	16.2-19.8	1	26.5	9.43	34.0	89.1	0.079	360
Z1022	17.8	5	19.8-24.2	1	31.9	7.83	41.2	73.5	0.082	290
Z1027	21.8	5	24.3-29.7	1	39.1	6.39	50.5	60.0	0.085	240
Z1033	26.8	5	29.7-36.3	1	47.7	5.24	61.7	49.1	0.087	200
Z1039	31.6	5	35.1-42.9	1	56.4	4.43	73.0	41.5	0.090	170
Z1047	38.1	5	42.3-51.7	1	67.8	3.69	88.0	34.4	0.092	140
Z1056	45.4	5	50.4-61.6	1	80.5	3.10	105.0	28.8	0.094	110
Z1068	55.1	5	61.2-74.8	1	98.0	2.55	127.0	23.8	0.096	90
Z1082	66.4	5	73.8-90.2	1	118.0	2.14	153.0	19.8	0.099	80
Z1100	81.0	5	90.0-110	1	144.0	1.73	187.0	16.2	0.101	65
Z1120	97.0	5	108-132	1	173.0	1.44	222.0	13.6	0.103	53
Z1150	121.0	5	135-165	1	215.0	1.16	277.0	10.9	0.105	42

Z2 type VRD has bipolar or unipolar electrical characteristics.

Maximum ratings
 Peak pulse power: 500 W (10/1000 μ s)
 6.00 kW (8/20 μ s)
 Steady state power dissipation: 1W
 Operating and storage temperature
 : -40°C to 125°C

Symbol mark

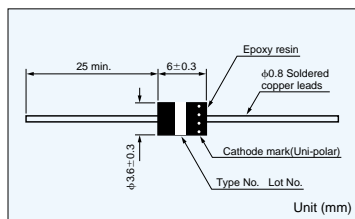
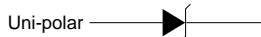

Bi-polar type	Uni-polar type	Stand-off voltage V_s V	Maximum leakage current I_L μ A	Breakdown voltage V_B V	Test current I_T mA	Maximum clamping voltage & Maximum peak pulse current				Max. temp. coef. %/°C	Capacitance (TYP) pF
						10/1000 μ s		8/20 μ s			
						V_C V	I_P A	V_C V	I_P A		
Z2008	-	6.63	500	7.38-9.02	10	12.5	40.0	16.3	372	0.045	1200
-	Z2008U	6.63	500	7.38-9.02	10	12.5	40.0	16.3	372	0.063	2400
Z2010	-	8.10	100	9.00-11.0	1	15.0	33.4	19.5	311	0.055	950
-	Z2010U	8.10	20	9.00-11.0	1	15.0	33.4	19.5	311	0.071	1900
Z2012	-	9.72	5	10.8-13.2	1	17.3	28.9	22.7	267	0.066	790
-	Z2012U	9.72	5	10.8-13.2	1	17.3	28.9	22.7	267	0.074	1580
Z2015	-	12.1	5	13.5-16.5	1	22.0	22.7	28.4	213	0.075	640
-	Z2015U	12.1	5	13.5-16.5	1	22.0	22.7	28.4	213	0.079	1280
Z2018	-	14.5	5	16.2-19.8	1	26.5	18.8	34.0	178	0.079	520
-	Z2018U	14.5	5	16.2-19.8	1	26.5	18.8	34.0	178	0.083	1040
Z2022	-	17.8	5	19.8-24.2	1	31.9	15.7	41.2	147	0.082	420
-	Z2022U	17.8	5	19.8-24.2	1	31.9	15.7	41.2	147	0.086	840
Z2027	-	21.8	5	24.3-29.7	1	39.1	12.8	50.5	120	0.085	340
-	Z2027U	21.8	5	24.3-29.7	1	39.1	12.8	50.5	120	0.089	680
Z2033	-	26.8	5	29.7-36.3	1	47.7	10.5	61.7	98.2	0.087	280
-	Z2033U	26.8	5	29.7-36.3	1	47.7	10.5	61.7	98.2	0.092	560
Z2039	-	31.6	5	35.1-42.9	1	56.4	8.86	73.0	83.0	0.090	240
-	Z2039U	31.6	5	35.1-42.9	1	56.4	8.86	73.0	83.0	0.095	480
Z2047	-	38.1	5	42.3-51.7	1	67.8	7.37	88.0	68.9	0.092	200
-	Z2047U	38.1	5	42.3-51.7	1	67.8	7.37	88.0	68.9	0.097	400
Z2056	-	45.4	5	50.4-61.6	1	80.5	6.21	105.0	57.7	0.094	160
-	Z2056U	45.4	5	50.4-61.6	1	80.5	6.21	105.0	57.7	0.099	320
Z2068	-	55.1	5	61.2-74.8	1	98.0	5.10	127.0	47.7	0.096	130
-	Z2068U	55.1	5	61.2-74.8	1	98.0	5.10	127.0	47.7	0.100	260
Z2082	-	66.4	5	73.8-90.2	1	118.0	4.24	153.0	39.6	0.099	110
-	Z2082U	66.4	5	73.8-90.2	1	118.0	4.24	153.0	39.6	0.102	220
Z2100	-	81.0	5	90.0-110	1	144.0	3.47	187.0	32.4	0.101	90
-	Z2100U	81.0	5	90.0-110	1	144.0	3.47	187.0	32.4	0.104	180
Z2120	-	97.2	5	108-132	1	173.0	2.89	222.0	27.3	0.103	75
-	Z2120U	97.2	5	108-132	1	173.0	2.89	222.0	27.3	0.106	150
Z2150	-	121.0	5	135-165	1	215.0	2.32	277.0	21.9	0.105	60
-	Z2150U	121.0	5	135-165	1	215.0	2.32	277.0	21.9	0.107	120
Z2180	-	146.0	5	162-198	1	258.0	1.94	333.0	18.2	0.106	49
-	Z2180U	146.0	5	162-198	1	258.0	1.94	333.0	18.2	0.108	98

NOTE: Nonsuffix: bi-polar, suffix "U" : uni-polar.

Bi-polar type	Uni-polar type	Stand-off voltage V _s V	Maximum leakage current I _L μA	Breakdown voltage V _B V	Test current I _T mA	Maximum clamping voltage & Maximum peak pulse current				Max. temp. coef. %/°C	Capacitance (TYP) pF
						10/1000μs		8/20μs			
						V _C V	I _p A	V _C V	I _p A		
-	Z6008U	6.63	500	7.38-9.02	10	12.5	120	16.3	1120	0.063	14600
Z6010	-	8.10	200	9.00-11.0	1	15.0	100	19.5	933	0.055	5600
-	Z6010U	8.10	50	9.00-11.0	1	15.0	100	19.5	933	0.071	11200
Z6012	-	9.72	10	10.8-13.2	1	17.3	86.7	22.7	802	0.066	4400
-	Z6012U	9.72	5	10.8-13.2	1	17.3	86.7	22.7	802	0.074	8800
Z6015	-	12.1	5	13.5-16.5	1	22.0	68.2	28.4	641	0.075	3300
-	Z6015U	12.1	5	13.5-16.5	1	22.0	68.2	28.4	641	0.079	6600
Z6018	-	14.5	5	16.2-19.8	1	26.5	56.6	34.0	535	0.079	2700
-	Z6018U	14.5	5	16.2-19.8	1	26.5	56.6	34.0	535	0.083	5400
Z6022	-	17.8	5	19.8-24.2	1	31.9	47.0	41.2	442	0.082	2400
-	Z6022U	17.8	5	19.8-24.2	1	31.9	47.0	41.2	442	0.086	4400
Z6027	-	21.8	5	24.3-29.7	1	39.1	38.5	50.5	360	0.085	1700
-	Z6027U	21.8	5	24.3-29.7	1	39.1	38.4	50.5	360	0.089	3300
Z6033	-	26.8	5	29.7-36.3	1	47.7	31.4	61.7	295	0.087	1400
-	Z6033U	26.8	5	29.7-36.3	1	47.7	31.4	61.7	295	0.092	2800
Z6039	-	31.6	5	35.1-42.9	1	56.4	26.6	73.0	249	0.090	1200
-	Z6039U	31.6	5	35.1-42.9	1	56.4	26.6	73.0	249	0.095	2400
Z6047	-	38.1	5	42.3-51.7	1	67.8	22.1	88.0	207	0.092	1000
-	Z6047U	38.1	5	42.3-51.7	1	67.8	22.1	88.0	207	0.097	2000
Z6056	-	45.4	5	50.4-61.6	1	80.5	18.6	105.0	173	0.094	850
-	Z6056U	45.4	5	50.4-61.6	1	80.5	18.6	105.0	173	0.099	1700
Z6068	-	55.1	5	61.2-74.8	1	98.0	15.3	127.0	143	0.096	720
-	Z6068U	55.1	5	61.2-74.8	1	98.0	15.3	127.0	143	0.100	1440
Z6082	-	66.4	5	73.8-90.2	1	118.0	12.7	153.0	119	0.099	610
-	Z6082U	66.4	5	73.8-90.2	1	118.0	12.7	153.0	119	0.102	1220
Z6100	-	81.0	5	90.0-110	1	144.0	10.4	187.0	97.3	0.101	520
-	Z6100U	81.0	5	90.0-110	1	144.0	10.4	187.0	97.3	0.104	1040
Z6120	-	97.2	5	108-132	1	173.0	8.67	222.0	82.0	0.103	440
-	Z6120U	97.2	5	108-132	1	173.0	8.67	222.0	82.0	0.106	880
-	Z6150U	121.0	5	135-165	1	215.0	6.98	277.0	65.7	0.107	720

NOTE : Nonsuffix : Bi-polar, suffix "U" : Uni-polar.

Z6 type VRD has bipolar or unipolar electrical characteristics.

Maximum ratings
Peak pulse power:1.5kW(10/1000μs)
18.0kW(8/20μs)
Steady state power dissipation:2W
Operating and storage temperature
:-40°C to 125°C

Symbol mark

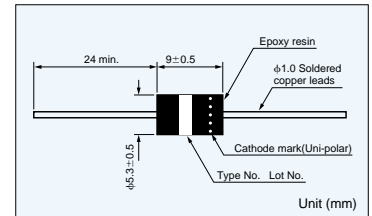
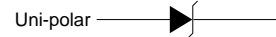

VRD type No.	Stand-off voltage V _s V	Maximum leakage current I _L μA	Breakdown voltage V _B V	Test current I _T mA	Maximum clamping voltage & Maximum peak pulse current				Max. temp. coef. %/°C	Capacitance (TYP) pF
					10/1000μs		8/20μs			
					V _C V	I _p A	V _C V	I _p A		
ZD015	11.4	10	12.8-17.2	1	24.0	10.4	31.0	96.7	0.075	31.5
ZD018	13.7	10	15.3-20.7	1	28.0	8.93	36.0	83.3	0.079	31.0
ZD022	16.8	5	18.7-25.3	1	33.2	7.53	43.0	69.7	0.082	29.0
ZD027	20.6	5	23.0-31.0	1	40.0	6.25	52.0	57.7	0.085	28.2
ZD033	25.2	5	28.1-37.9	1	48.6	5.14	63.0	47.6	0.087	27.2
ZD039	29.8	5	33.2-44.8	1	57.4	4.35	74.0	40.5	0.090	26.3
ZD047	35.9	5	40.0-54.0	1	68.5	3.65	89.0	33.7	0.092	25.0
ZD056	42.8	5	47.6-64.4	1	81.0	3.08	106.0	28.6	0.094	24.1
ZD068	52.0	5	57.8-78.2	1	98.0	2.55	127.0	23.8	0.096	22.0

Low capacitance type

Maximum ratings
Reverse voltage:200 VDC
Peak pulse power:250 W(10/1000μs)
3.00 kW(8/20μs)
Steady state power dissipation:500 mW
Operating and storage temperature
:-40°C to 125°C

Symbol mark

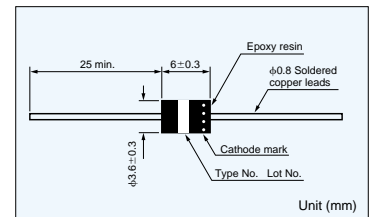

SMD VRD

Part number

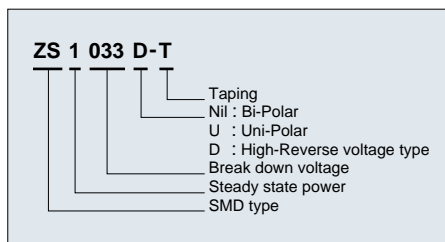

Dimensions

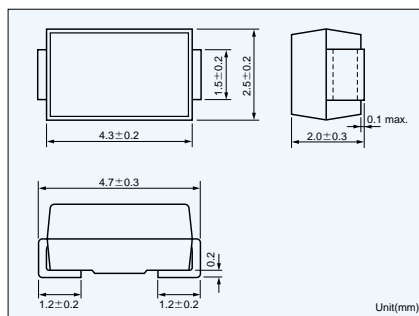

Marking

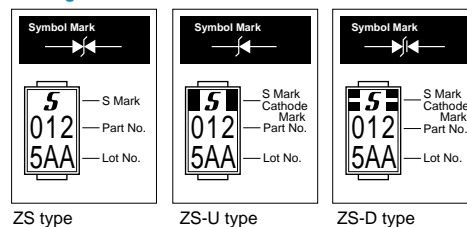

	Maximum Rating
Steady state power dissipation	1.0W
Peak pulse power	300W(10/1000μs)
	1200W(1.2/50μs)
	2000W(8/20μs)
Storage temp. range	-40~150°C

Taping

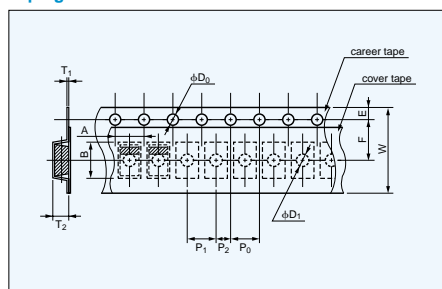

A	B	W	F	E	P ₁	P ₂	P ₀	φD ₀	φD ₁	T ₁	T ₂
3.0 ±0.1	5.2 ±0.1	12.0 ±0.3	5.5 ±0.05	1.75 ±0.1	4.0 ±0.1	2.0 ±0.1	4.0 ±0.1	1.5 +0.1 -0	1.5 +0.2 -0	0.3 ±0.05	(2.6)

Dimension of reel

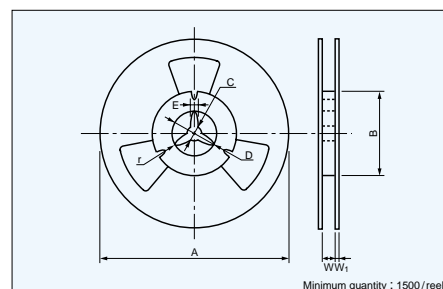

A	B	C	D	E	W	W ₁	r
φ178 ±2.0	φ80 ±1.0	φ13 ±0.5	φ21 ±0.8	2.0 ±0.5	14.0 ±1.5	1.5 +0.5 -1.0	(1.0)

Specifications

ZS type

Part No.	Breakdown voltage	Stand-off voltage	Maximum leakage current	Maximum clamping voltage & Maximum peak pulse current				Temperature coefficient	Capacitance (TYP)						
				V _B	V _S	I _L max	V _C max/I _{PP}								
							It=1mA			D.C.	V _S	10/1000μs		8/20μs	
												V	A	V	A
ZS1012	12(10.8~13.2)	9.72	10	17.3	17.3	22.4	89.3	0.066	551						
ZS1015	15(13.5~16.5)	12.1	5	22.0	13.6	28.5	70.2	0.075	465						
ZS1018	18(16.2~19.8)	14.5	5	26.5	11.3	34.4	58.1	0.079	376						
ZS1022	22(19.8~24.2)	17.8	5	31.9	9.40	41.4	48.3	0.082	299						
ZS1027	27(24.3~29.7)	21.8	5	39.1	7.67	50.7	39.4	0.085	248						
ZS1033	33(29.7~36.3)	26.8	5	47.7	6.29	61.8	32.4	0.087	198						
ZS1039	39(35.1~42.9)	31.6	5	56.4	5.32	73.1	27.4	0.090	164						
ZS1047	47(42.3~51.7)	38.1	5	67.8	4.42	88.0	22.7	0.092	137						

ZS-U type

Part No.	Breakdown voltage	Stand-off voltage	Maximum leakage current	Maximum clamping voltage & Maximum peak pulse current				Temperature coefficient	Capacitance (TYP)						
				V _B	V _S	I _L max	V _C max/I _{PP}								
							It=1mA			D.C.	V _S	10/1000μs		8/20μs	
												V	A	V	A
ZS1012U	12(10.8~13.2)	9.72	10	17.3	17.3	22.4	89.3	0.066	1,102						
ZS1015U	15(13.5~16.5)	12.1	5	22.0	13.6	28.5	70.2	0.075	929						
ZS1018U	18(16.2~19.8)	14.5	5	26.5	11.3	34.4	58.1	0.079	751						
ZS1022U	22(19.8~24.2)	17.8	5	31.9	9.40	41.4	48.3	0.082	598						
ZS1027U	27(24.3~29.7)	21.8	5	39.1	7.67	50.7	39.4	0.085	497						
ZS1033U	33(29.7~36.3)	26.8	5	47.7	6.29	61.8	32.4	0.087	395						
ZS1039U	39(35.1~42.9)	31.6	5	56.4	5.32	73.1	27.4	0.090	328						
ZS1047U	47(42.3~51.7)	38.1	5	67.8	4.42	88.0	22.7	0.092	274						

ZS-D type

Part No.	Breakdown voltage	Stand-off voltage	Maximum leakage current	Maximum clamping voltage & Maximum peak pulse current				Temperature coefficient	Capacitance (TYP)						
				V _B	V _S	I _L max	V _C max/I _{PP}								
							It=1mA			D.C.	V _S	10/1000μs		8/20μs	
												V	A	V	A
ZS1012D	12(10.8~13.2)	9.72	10	17.3	17.3	22.4	89.3	0.066	30.2						
ZS1015D	15(13.5~16.5)	12.1	5	22.0	13.6	28.5	70.2	0.075	29.1						
ZS1018D	18(16.2~19.8)	14.5	5	26.5	11.3	34.4	58.1	0.079	28.2						
ZS1022D	22(19.8~24.2)	17.8	5	31.9	9.40	41.4	48.3	0.082	27.3						
ZS1027D	27(24.3~29.7)	21.8	5	39.1	7.67	50.7	39.4	0.085	26.4						
ZS1033D	33(29.7~36.3)	26.8	5	47.7	6.29	61.8	32.4	0.087	25.5						
ZS1039D	39(35.1~42.9)	31.6	5	56.4	5.32	73.1	27.4	0.090	24.8						
ZS1047D	47(42.3~51.7)	38.1	5	67.8	4.42	88.0	22.7	0.092	24.0						

CURRENT REGULATIVE DIODE

CRD

CRD is a diode which supplies constant current to an electric circuit, even when power supply voltage fluctuations or load impedance fluctuations occur.

CRD is used for current stabilization and current limiting.

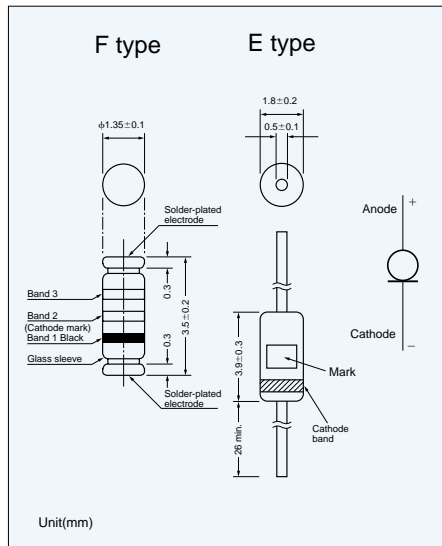
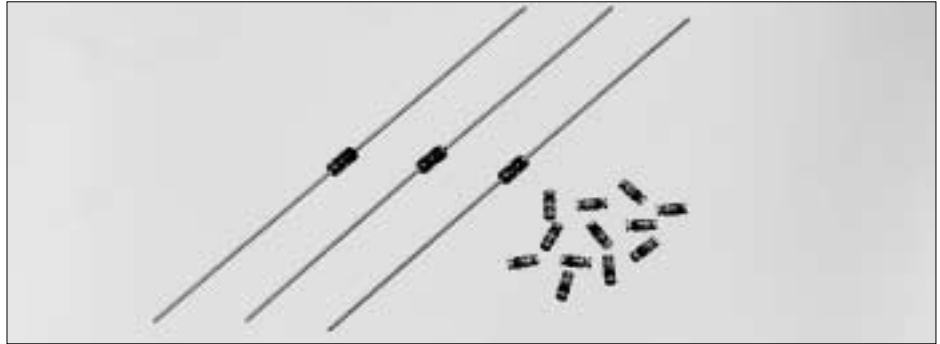

Basic characteristics

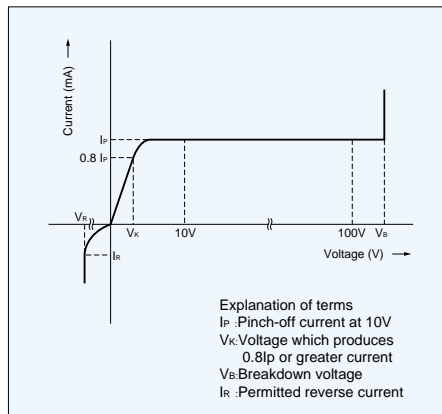

Maximum ratings

	E type	F type
Rating power	300mW	400mW
Thermal resistance	300°C/W	150°C/W
Reverse current	50mA	
Operating temp	-30°C~150°C	

Maximum rating voltage

Part No.	Voltage	Part No.	Voltage
E101L~E-562	100V	F101L~F-562	100V
E-822	30	F-822	50
E-103	30	F-103	42
E-123	30	F-123	34
E-153	25	F-153	28

Specifications

Part No.	Pinch-off current*1	Limiting current*2	Dynamic impedance*3	Limiting current ratio	Temperature coefficient	Indication					
						Test Voltage	I_p (mA)	V_k (V)	I_k (mA)	Z_T (M Ω)	$I_{100V}/I_p^{150V}/I_p$
lead less	with lead					Band 2	Band 3	Type			
F-101L	E-101L	10V	0.01~0.06	0.4	0.8Ipmin.	8.00	1.1 max.	+2.10~+0.10	Light blue	White	1L
F-101	E-101	10V	0.05~0.21	0.5	0.8Ipmin.	6.00	1.1 max.	+2.10~+0.10	Light blue	Pink	01
F-301	E-301	10V	0.20~0.42	0.8	0.8Ipmin.	4.00	1.1 max.	+0.40~-0.20	Light blue	Orange	03
F-501	E-501	10V	0.40~0.63	1.1	0.8Ipmin.	2.00	1.1 max.	+0.15~-0.25	Light blue	Yellow green	05
F-701	E-701	10V	0.60~0.92	1.4	0.8Ipmin.	1.00	1.1 max.	0.00~-0.32	Light blue	Blue	07
F-102	E-102	10V	0.88~1.32	1.7	0.8Ipmin.	0.65	1.1 max.	-0.10~-0.37	Yellow green	Pink	10
F-152	E-152	10V	1.28~1.72	2.0	0.8Ipmin.	0.40	1.1 max.	-0.13~-0.40	Yellow green	Orange	15
F-202	E-202	10V	1.68~2.32	2.3	0.8Ipmin.	0.25	1.1 max.	-0.15~-0.42	Yellow green	Yellow green	20
F-272	E-272	10V	2.28~3.10	2.7	0.8Ipmin.	0.15	1.1 max.	-0.18~-0.45	Yellow green	Light blue	27
F-352	E-352	10V	3.00~4.10	3.2	0.8Ipmin.	0.10	1.1 max.	-0.20~-0.47	Yellow green	Blue	35
F-452	E-452	10V	3.90~5.10	3.7	0.8Ipmin.	0.07	1.1 max.	-0.22~-0.50	Yellow green	Purple	45
F-562	E-562	10V	5.00~6.50	4.5	0.8Ipmin.	0.04	1.1 max.	-0.25~-0.53	Yellow green	White	56
F-822	E-822	10V	6.56~9.84	3.1	0.8Ipmin.	0.32	*1.0 max.	-0.25~-0.45	Yellow green	Yellow	82
F-103	E-103	10V	8.00~12.0	3.5	0.8Ipmin.	0.17	*1.0 max.	-0.25~-0.45	Orange	Pink	10
F-123	E-123	10V	9.60~14.4	3.8	0.8Ipmin.	0.08	*1.0 max.	-0.25~-0.45	Orange	White	12
F-153	E-153	10V	12.0~18.0	4.3	0.8Ipmin.	0.03	*1.0 max.	-0.25~-0.45	Orange	Light blue	15

*1,2 Pinch-off current limiting current are measured by impulse wave at 25°C

*3 Z_T is minimum AC impedance when small AC signal voltage of 10KHz is added to 25 Vdc bias. Z_T is used as the reference value.

*4 Temperature coefficient is measured between 25°C and 50°C.

Taping

There are three Types for taping.

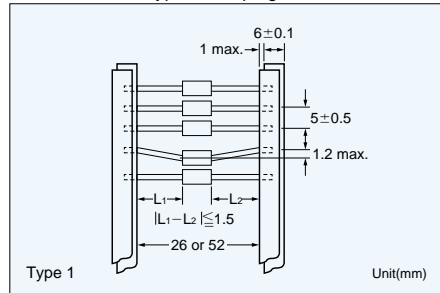

Type 1

Unit(mm)

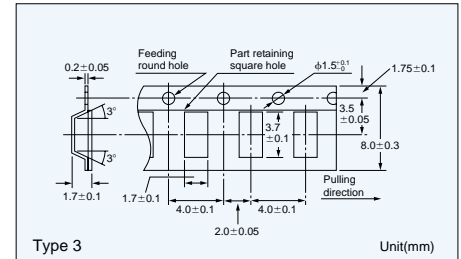

Type 3

Unit(mm)

*In principal elements are set with cathode side on the round hole side.

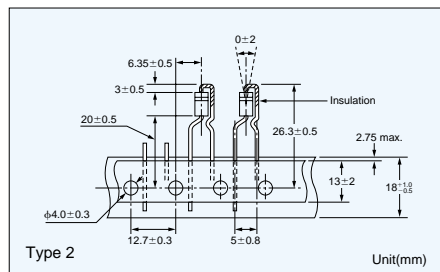

Type 2

Unit(mm)

Minimum taping quantity for

Type 1 Roll.....5000pcs

Box.....2500pcs

Type 2 4000pcs

Type 3 2500pcs

Power derating



Pinch-off current Temperature



CRD in parallel

The use of CRD in parallel increases their current handling capabilities.

Increasing the voltage range using a zener diode

Connecting zener diodes in series with the line ensures that the current is constant in high-voltage area.



The compensation of current reduction due to self heating

Placing resistors in parallel with CRD can correct any current decrease when the applied voltage increases. The following values are typical for correction resistors.

E-102	1MΩ	E-352	82kΩ
E-152	390kΩ	E-452	56kΩ
E-202	240kΩ	E-562	39kΩ
E-272	120kΩ		

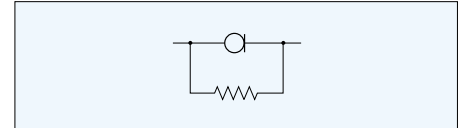

Compensative resistor is not necessary if the current value is less than 1 mA.



Dynamic characteristics (saturation characteristics)

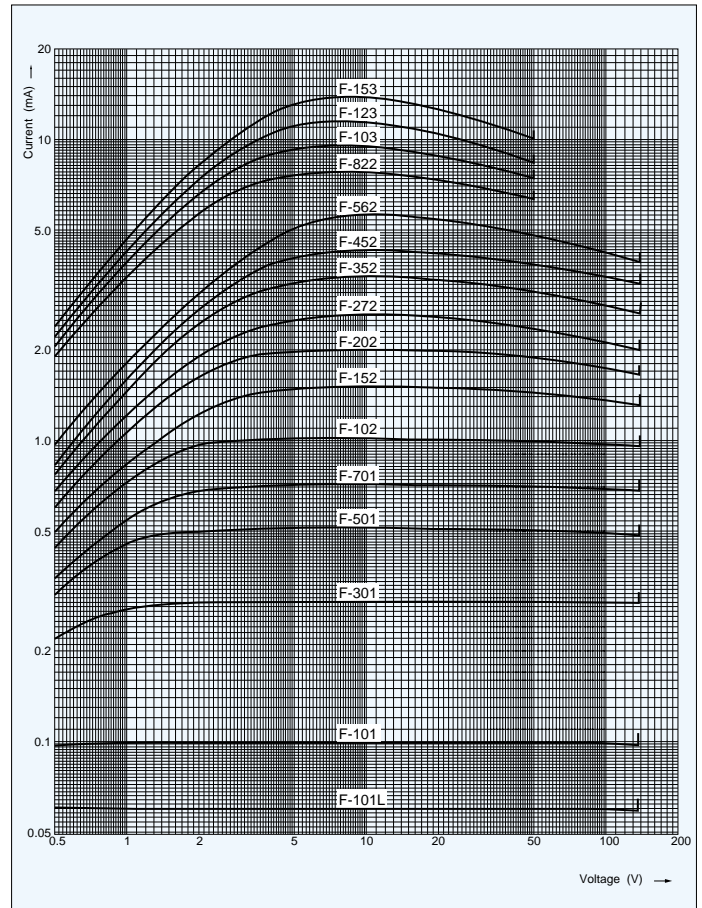
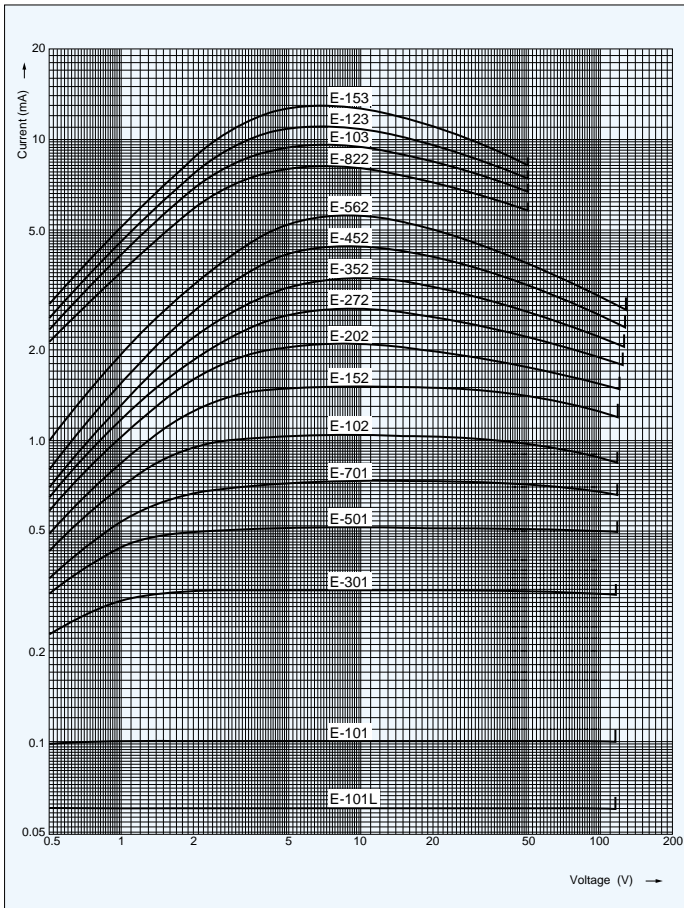

METAL OXIDE VARISTOR

ZENAMIC

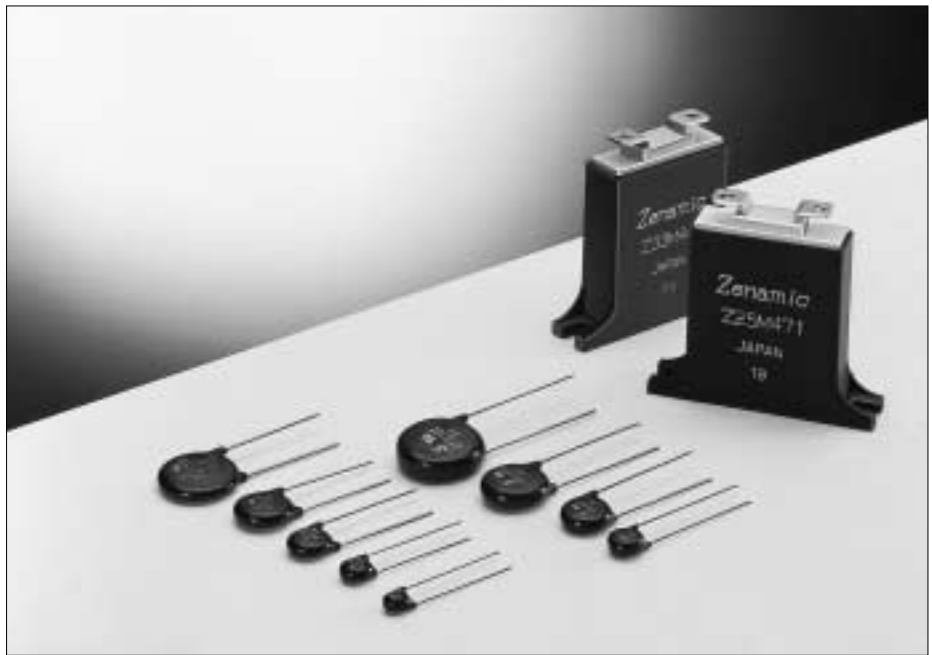

ZENAMIC is the product name of a metal oxide varistor. ZENAMIC Transient/ Surge Absorber, Series D is newly released through our continued research in ceramic material composition of ZnO varistor and manufacturing process, featuring large surge current handling capability and energy handling capability for absorbing transient overvoltage in compact size.

Features

- Improved in "Surge Current Handling Capability (@8/20 μ s, 2 times)" by about 2 times over the current.
- Very large "Energy Handling Capability" absorbing transient overvoltages in compact sizes.
- Lower Clamping Voltage for better surge protection.
- Fast response to high speed transient/ surge voltage.
- Wide products range for transient/surge protection on AC 100V to AC 480V nominal system with the maximum peak current ratings of 600A to 7000A (@8/20 μ s, 2 times).

V-I characteristics

ZENAMIC has the forward-reverse symmetrical electrical characteristics as shown in the figure 1. The voltage-current curves show the varistor characteristics in the range 1 μA to 10⁴A, and show the resistance characteristics for the range under 1 μA and over 10⁴A in the figure 2. The voltage across terminals when test current(I_t: 1 mA) is applied to ZENAMIC is the standard varistor voltage(V_Z), and the voltage across terminals when a standard surge(I_p) is applied represents the maximum suppression voltage(V_C).

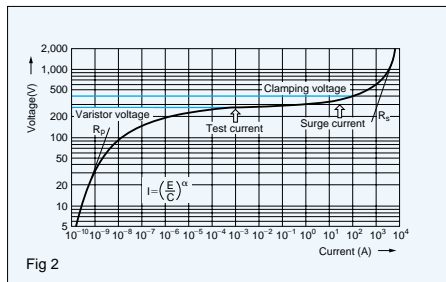

Temperature characteristics

In the small current range, ZENAMIC features outstanding temperature characteristics. A shunt resistance R_p of metal oxide varistor has the temperature characteristics which is determined by the following equation.

$$R_p = A e^{E_g / 2kT} \quad (2)$$

T: Absolute temperature
k: Boltzmann constant
A, E_g: constants

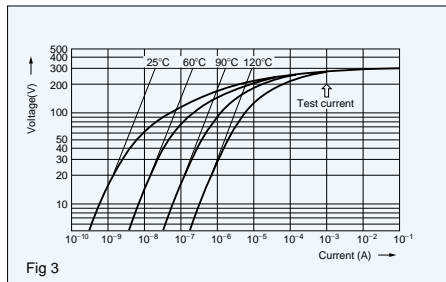

As shown in the figure 3, the temperature dependence characteristics are shown clearly in the low current area.

Surge waveform

A surge waveform varies according to the sources. An EXP waveform is used for surge testing of ZENAMIC, while a AC half-wave is used for the energy absorption test. The EXP waveform reaches its peak voltage (current) at [t_a] as shown in the figure 5, and then decreases as time passes and reaches half of the peak voltage (current) at [t_b]. This type of the EXP waveform is shown as a [t_a/t_b] voltage (current) waveform. For surge testing of ZENAMIC, the 8/20 μ sec current waveform is used.

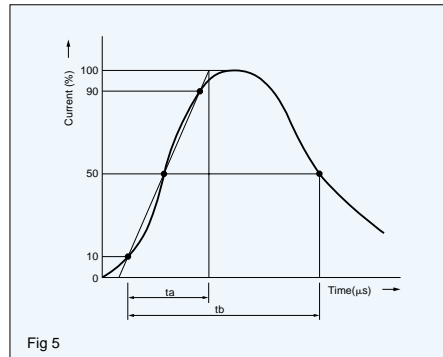

Part No.

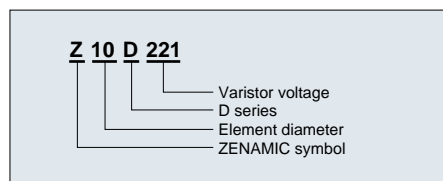

Application notes(General)

1. A surge excess of the specified Maximum Peak Current may cause short circuit or mechanical damage. The following measures are recommended.

- In case that ZENAMIC is used in line to ground, the ground fault circuit interrupter shall be applied in location A or thermally coupled fuse shall be applied in location C.
- ZENAMIC shall not be used near heat generating device and free from direct sunlight.
- ZENAMIC shall not be used near the flammable materials.

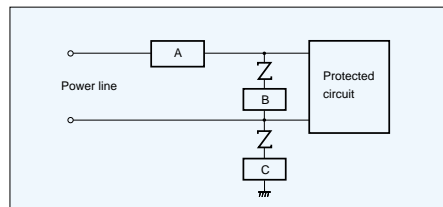

- 1) Location of the over current protector (circuit breaker or current fuse) shall be in the power line to the circuit (Location A) or in series with ZENAMIC (Location B).
- 2) It is recommended that a fuse listed in the table be put in location A or B.
- 3) In case that ZENAMIC is used in line to ground, the ground fault circuit interrupter should be applied in location A or thermally coupled fuse should be applied in location C.

Part Number	Z5D□□□	Z7D□□□	Z10D□□□
Rating of fuse	3A max.	5A max.	7A max.

Part Number	Z15D□□□	Z21D□□□
Rating of fuse	10A max.	15A max.

Refer to the related Safety Standards.

Applications

Power lines and surge absorption units with error display (SA series).

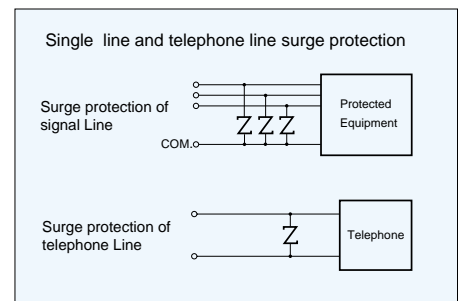
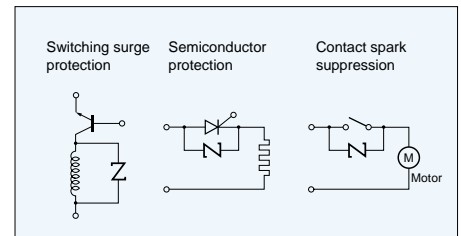
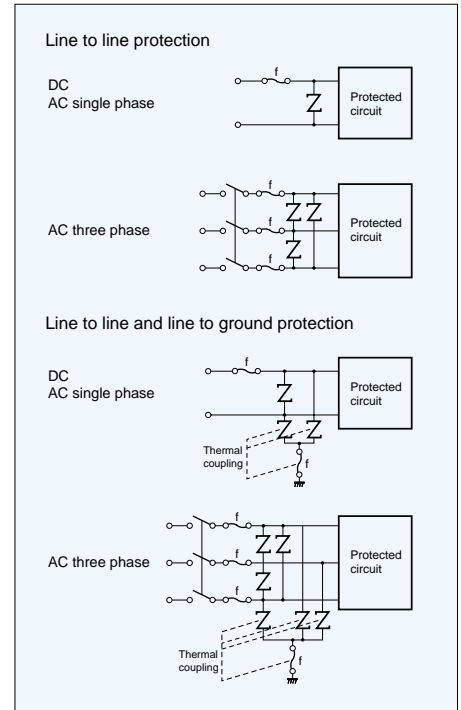

Z5D Series

Specifications

Part No.	Varistor Voltage	Maximum Allowable Voltage		Clamping Voltage (max.)	Rated Power	Maximum Energy		Maximum Peak Current (8/20 μ s)		Capacitance (max.) 1kHz
		AC _{rms} (V)	DC(V)			(10/1000 μ s)	(2ms)	1 time	2 times	
Z5D180	18(16-20)	11	14	40 at 1A	0.01	0.6	0.4	250	125	1600
Z5D220	22(20-24)	14	18	48	0.01	0.7	0.5	250	125	1500
Z5D270	27(24-30)	17	22	60	0.01	0.9	0.7	250	125	1450
Z5D330	33(30-36)	20	26	73	0.01	1.1	0.8	250	125	1400
Z5D390	39(35-43)	25	31	86	0.01	1.2	0.9	250	125	700
Z5D470	47(42-52)	30	38	104	0.01	1.5	1.1	250	125	650
Z5D560	56(50-62)	35	45	123	0.01	1.8	1.3	250	125	600
Z5D680	68(61-75)	40	56	150	0.01	2.2	1.6	250	125	580
*1 Z5D820	82(74-90)	50	65	145 at 5A	0.1	3.5	2.5	800	600	460
*1 Z5D101	100(90-110)	60	85	175	0.1	4.0	3.0	800	600	400
*1 Z5D121	120(108-132)	75	100	210	0.1	5.0	3.5	800	600	350
*1 Z5D151	150(135-165)	95	125	260	0.1	6.5	4.5	800	600	300
*1 Z5D201	200(185-225)	130	170	355	0.1	8.5	6.0	800	600	120
*1 Z5D221	220(198-242)	140	180	380	0.1	9.0	6.5	800	600	110
*1 Z5D241	240(216-264)	150	200	415	0.1	10.5	7.5	800	600	100 *2
*1 Z5D271	270(247-303)	175	225	475	0.1	11.0	8.0	800	600	90 *2
*1 Z5D331	330(297-363)	210	270	570	0.1	13.0	9.5	800	600	80 *2
*1 Z5D361	360(324-396)	230	300	620	0.1	16.0	11.0	800	600	80 *2
*1 Z5D391	390(351-429)	250	320	675	0.1	17.0	12.0	800	600	80 *2
*1 Z5D431	430(387-473)	275	350	754	0.1	20.0	13.0	800	600	70 *2
*1 Z5D471	470(423-517)	300	385	810	0.1	21.0	15.0	800	600	60 *2

Z7D Series

Specifications

Part No.	Varistor Voltage	Maximum Allowable Voltage		Clamping Voltage (max.)	Rated Power	Maximum Energy		Maximum Peak Current (8/20 μ s)		Capacitance (max.) 1kHz
		AC _{rms} (V)	DC(V)			(10/1000 μ s)	(2ms)	1 time	2 times	
Z7D180	18(16-20)	11	14	36 at 2.5A	0.02	1.1	0.9	500	250	3800
Z7D220	22(20-24)	14	18	43	0.02	1.3	1.1	500	250	3600
Z7D270	27(24-30)	17	22	53	0.02	1.6	1.3	500	250	3400
Z7D330	33(30-36)	20	26	65	0.02	2.0	1.6	500	250	2900
Z7D390	39(35-43)	25	31	77	0.02	2.4	1.9	500	250	1600
Z7D470	47(42-52)	30	38	93	0.02	2.8	2.3	500	250	1550
Z7D560	56(50-62)	35	45	110	0.02	3.4	2.7	500	250	1500
Z7D680	68(61-75)	40	56	135	0.02	4.1	3.3	500	250	1200
*1 Z7D820	82(74-90)	50	65	135 at 10A	0.25	7	5	1750	1250	810
*1 Z7D101	100(90-110)	60	85	165	0.25	8.5	6	1750	1250	700
*1 Z7D121	120(108-132)	75	100	200	0.25	10	7	1750	1250	590
*1 Z7D151	150(135-165)	95	125	250	0.25	13	9	1750	1250	500
*1 Z7D201	200(185-225)	130	170	340	0.25	17.5	12.5	1750	1250	200
*1 Z7D221	220(198-242)	140	180	360	0.25	19	13.5	1750	1250	190
*1 Z7D241	240(216-264)	150	200	395	0.25	21	15	1750	1250	170
*1 Z7D271	270(247-303)	175	225	455	0.25	24	17	1750	1250	150
*1 Z7D331	330(297-363)	210	270	545	0.25	28	20	1750	1250	130
*1 Z7D361	360(324-396)	230	300	595	0.25	32	23	1750	1250	130
*1 Z7D391	390(351-429)	250	320	650	0.25	35	25	1750	1250	130
*1 Z7D431	430(387-473)	275	350	710	0.25	40	27.5	1750	1250	120
*1 Z7D471	470(423-517)	300	385	775	0.25	42	30	1750	1250	100 *2
*1 Z7D511	510(459-561)	320	410	845	0.25	45	32	1750	1250	90 *2

1. Operating temperature range: -40 to 85°C
 2. Storage temperature range: -40 to 125°C
- *1 UL 1449 approved model
*2 Measured at 1MHz

Z10D Series

Specifications

Part No.	Varistor Voltage	Maximum Allowable Voltage		Clamping Voltage (max.)	Rated Power	Maximum Energy		Maximum Peak Current (8/20 μ s)		Capacitance (max.) 1kHz		
		AC _{rms} (V)	DC(V)			V(V)	(W)	(10/1000 μ s)	(2ms)		1 time	2 times
								(J)	(J)		(A)	(A)
Z10D180	18(16-20)	11	14	36 at 5A	0.05	2.6	2.2	1000	500	16000		
Z10D220	22(20-24)	14	18	43	0.05	3.2	2.6	1000	500	11000		
Z10D270	27(24-30)	17	22	53	0.05	3.9	3.2	1000	500	8000		
Z10D330	33(30-36)	20	26	65	0.05	4.8	4.0	1000	500	6300		
Z10D390	39(35-43)	25	31	77	0.05	5.6	4.7	1000	500	5200		
Z10D470	47(42-52)	30	38	93	0.05	6.8	5.6	1000	500	4600		
Z10D560	56(50-62)	35	45	110	0.05	8.1	6.7	1000	500	3750		
Z10D680	68(61-75)	40	56	135	0.05	9.8	8.2	1000	500	2800		
* Z10D820	82(74-90)	50	65	135 at 25A	0.4	14	10	3500	2500	2000		
* Z10D101	100(90-110)	60	85	165	0.4	17	12	3500	2500	1700		
* Z10D121	120(108-132)	75	100	200	0.4	20	14.5	3500	2500	1400		
* Z10D151	150(135-165)	95	125	250	0.4	25	18	3500	2500	1100		
* Z10D201	200(185-225)	130	170	340	0.4	35	25	3500	2500	430		
* Z10D221	220(198-242)	140	180	360	0.4	39	27.5	3500	2500	410		
* Z10D241	240(216-264)	150	200	395	0.4	42	30	3500	2500	380		
* Z10D271	270(247-303)	175	225	455	0.4	49	35	3500	2500	350		
* Z10D331	330(297-363)	210	270	545	0.4	58	42	3500	2500	300		
* Z10D361	360(324-396)	230	300	595	0.4	65	45	3500	2500	300		
* Z10D391	390(351-429)	250	320	650	0.4	70	50	3500	2500	300		
* Z10D431	430(387-473)	275	350	710	0.4	80	55	3500	2500	270		
* Z10D471	470(423-517)	300	385	775	0.4	85	60	3500	2500	230		
* Z10D511	510(459-561)	320	410	845	0.4	92	67	3500	2500	210		
* Z10D561	560(504-616)	350	450	930	0.4	92	67	3500	2500	200		
* Z10D681	680(612-748)	420	560	1120	0.4	92	67	3500	2500	170		
* Z10D751	750(675-825)	460	615	1240	0.4	100	70	3500	2500	160		
* Z10D821	820(738-902)	510	670	1355	0.4	110	80	3500	2500	140		
* Z10D911	910(819-1001)	550	745	1500	0.4	130	90	3500	2500	120		
* Z10D102	1000(900-1100)	625	825	1650	0.4	140	100	3500	2500	110		

Z15D Series

Specifications

Part No.	Varistor Voltage	Maximum Allowable Voltage		Clamping Voltage (max.)	Rated Power	Maximum Energy		Maximum Peak Current (8/20 μ s)		Capacitance (max.) 1kHz		
		AC _{rms} (V)	DC(V)			V(V)	(W)	(10/1000 μ s)	(2ms)		1 time	2 times
								(J)	(J)		(A)	(A)
Z15D180	18(16-20)	11	14	36 at 10A	0.1	5.2	4.3	2000	1000	25000		
Z15D220	22(20-24)	14	18	43	0.1	6.3	5.3	2000	1000	20000		
Z15D270	27(24-30)	17	22	53	0.1	7.8	6.5	2000	1000	16000		
Z15D330	33(30-36)	20	26	65	0.1	9.5	7.9	2000	1000	12200		
Z15D390	39(35-43)	25	31	77	0.1	11	9.4	2000	1000	7000		
Z15D470	47(42-52)	30	38	93	0.1	14	11	2000	1000	6750		
Z15D560	56(50-62)	35	45	110	0.1	16	13	2000	1000	6500		
Z15D680	68(61-75)	40	56	135	0.1	20	16	2000	1000	5500		
* Z15D820	82(74-90)	50	65	135 at 50A	0.6	28	20	6000	4500	3700		
* Z15D101	100(90-110)	60	85	165	0.6	35	25	6000	4500	3200		
* Z15D121	120(108-132)	75	100	200	0.6	42	30	6000	4500	2700		
* Z15D151	150(135-165)	95	125	250	0.6	53	37.5	6000	4500	2200		
* Z15D201	200(185-225)	130	170	340	0.6	70	50	6000	4500	770		
* Z15D221	220(198-242)	140	180	360	0.6	78	55	6000	4500	740		
* Z15D241	240(216-264)	150	200	395	0.6	84	60	6000	4500	700		
* Z15D271	270(247-303)	175	225	455	0.6	99	70	6000	4500	640		
* Z15D331	330(297-363)	210	270	545	0.6	115	80	6000	4500	580		
* Z15D361	360(324-396)	230	300	595	0.6	130	90	6000	4500	540		
* Z15D391	390(351-429)	250	320	650	0.6	140	100	6000	4500	500		
* Z15D431	430(387-473)	275	350	710	0.6	155	110	6000	4500	450		
* Z15D471	470(423-517)	300	385	775	0.6	175	125	6000	4500	400		
* Z15D511	510(459-561)	320	410	845	0.6	190	136	6000	4500	350		
* Z15D561	560(504-616)	350	450	930	0.6	190	136	6000	4500	340		
* Z15D681	680(612-748)	420	560	1120	0.6	190	136	5000	4500	320		
* Z15D751	750(675-825)	460	615	1240	0.6	210	150	5000	4500	310		
* Z15D821	820(738-902)	510	670	1355	0.6	235	165	5000	4500	280		
* Z15D911	910(819-1001)	550	745	1500	0.6	255	180	5000	4500	250		
* Z15D102	1000(900-1100)	625	825	1650	0.6	280	200	5000	4500	230		

1. Operating temperature range: -40 to 85°C
 2. Storage temperature range: -40 to 125°C
- * UL 1449 approved model

Z21D Series

Specifications

Part No.	Varistor Voltage	Maximum Allowable Voltage		Clamping Voltage (max.)	Rated Power	Maximum Energy		Maximum Peak Current (8/20 μ s)		Capacitance (max.) 1kHz
		AC _{rms} (V)	DC(V)			(10/1000 μ s)	(2ms)	1 time	2 times	
Z21D180	18(16-20)	11	14	36 at 20A	0.2	13	12	3000	2000	40000
Z21D220	22(20-24)	14	18	43	0.2	16	14	3000	2000	30000
Z21D270	27(24-30)	17	22	53	0.2	19	17	3000	2000	24500
Z21D330	33(30-36)	20	26	65	0.2	24	21	3000	2000	20000
Z21D390	39(35-43)	25	31	77	0.2	28	25	3000	2000	13800
Z21D470	47(42-52)	30	38	93	0.2	34	30	3000	2000	13500
Z21D560	56(50-62)	35	45	110	0.2	41	36	3000	2000	12200
Z21D680	68(61-75)	40	56	135	0.2	49	44	3000	2000	11500
* Z21D820	82(74-90)	50	65	135 at 100A	1.0	56	40	10000	6500	7500
* Z21D101	100(90-110)	60	85	165	1.0	70	50	10000	6500	6500
* Z21D121	120(108-132)	75	100	200	1.0	85	60	10000	6500	5500
* Z21D151	150(135-165)	95	125	250	1.0	106	75	10000	6500	4500
* Z21D201	200(185-225)	130	170	340	1.0	140	100	10000	6500	1700
* Z21D221	220(198-242)	140	180	360	1.0	155	110	10000	6500	1600
* Z21D241	240(216-264)	150	200	395	1.0	168	120	10000	6500	1500
* Z21D271	270(247-303)	175	225	455	1.0	190	135	10000	6500	1300
* Z21D331	330(297-363)	210	270	545	1.0	228	160	10000	6500	1100
* Z21D361	360(324-396)	230	300	595	1.0	255	180	10000	6500	1100
* Z21D391	390(351-429)	250	320	650	1.0	275	195	10000	6500	1100
* Z21D431	430(387-473)	275	350	710	1.0	303	215	10000	6500	1000
* Z21D471	470(423-517)	300	385	775	1.0	350	250	10000	6500	900
* Z21D511	510(459-561)	320	410	845	1.0	382	273	10000	6500	800
* Z21D561	560(504-616)	350	450	930	1.0	382	273	7500	6500	750
* Z21D681	680(612-748)	420	560	1120	1.0	382	273	7500	6500	650
* Z21D751	750(675-825)	460	615	1240	1.0	420	300	7500	6500	600
* Z21D821	820(738-902)	510	670	1355	1.0	460	325	7500	6500	530
* Z21D911	910(819-1001)	550	745	1500	1.0	510	360	7500	6500	500
* Z21D102	1000(900-1100)	625	825	1650	1.0	565	400	7500	6500	450

1. Operating temperature range: -40 to 85°C * UL 1449 approved model
 2. Storage temperature range: -40 to 125°C

Dimensions

Z5D

Z7D

Z10D

Z15D

Z21D

Crimped Leads and Taped
 Z5D □□□ T4C
 Z7D □□□ T4C

Straight Leads and Taped
 Z5D □□□ T4D
 Z7D □□□ T4D

*Dimension "T": Conforms to each individual specification
 *Packing quantity: 1000pcs/BOX

Symbol	Type I	Symbol	Type I
P	12.7±1.0	W ₀	5.0min
P ₀	12.7±0.3	W ₁	9.0±0.5
P ₁	3.85±0.70	W ₂	3max
P ₂	6.35±1.30	H	Approx. 22
φd	0.60 ^{+0.08} _{-0.05}	H ₀	17.0±0.5
F	5.0±0.5	φD ₀	φ4.0±0.2
Δh	0±2	t	0.6±0.3
W	18.0 ^{+1.0} _{-0.5}	L	11max
φD	Z5D: 7max, Z7D: 8.5max		

*Dimension "T": Conforms to each individual specification
 *Packing quantity: 1000pcs/BOX

Symbol	Type I	Symbol	Type I
P	12.7±1.0	W ₀	5.0min
P ₀	12.7±0.3	W ₁	9.0±0.5
P ₁	3.85±0.70	W ₂	3max
P ₂	6.35±1.30	H	Approx. 20
φd	0.60 ^{+0.08} _{-0.05}	H ₀	17.0±0.5
F	5.0±0.5	φD ₀	φ4.0±0.2
Δh	0±2	t	0.6±0.3
W	18.0 ^{+1.0} _{-0.5}	L	11max
φD			Z5D: 7max, Z7D: 8.5max

Unit(mm)

Z25M, Z33M Series

Specifications

Part No.	Varistor voltage $V_{1mA}(V)$		Maximum allowable voltage		Maximum clamping voltage	Rated wattage	Energy (2ms)	Withstanding Surge current (8/20 μ s)		Typical capacitance (@ 1kHz)
			AC	DC				1 Time	2 Times	
	Min	Max	V_{rms}	V	V	W	J			pF
Z25M221S	220(187 ~253)		120	165	380 at 150A	1.0	125	15000A	10000A	3300
Z25M271S	270(229.5~310.5)		150	210	465		155			2200
Z25M331S	330(280.5~379.5)		175	245	570		185			1900
Z25M391S	390(331.5~448.5)		210	295	675		215			1700
Z25M441S	440(374 ~506)		240	335	760		225			1500
Z25M471S	470(399.5~540.5)		250	350	810		235			1500
Z25M561S	560(476 ~644)		300	420	970		260			1400
Z25M681S	680(578 ~782)		365	510	1175		280			1250
Z25M821S	820(697 ~943)		440	615	1415		330			800
Z25M102S	1000(850 ~1,150)		520	730	1725		375			500
Z33M221S	220(187 ~253)		120	165	380 at 200A	1.2	200	25000A	20000A	5500
Z33M271S	270(229.5~310.5)		150	210	465		255			4200
Z33M331S	330(280.5~379.5)		175	245	570		310			3700
Z33M391S	390(331.5~448.5)		210	295	675		360			3200
Z33M441S	440(374 ~506)		240	335	760		370			2800
Z33M471S	470(399.5~540.5)		250	350	810		385			2600
Z33M561S	560(476 ~644)		300	420	970		425			2200
Z33M681S	680(578 ~782)		365	510	1175		460			1800
Z33M821S	820(697 ~943)		440	615	1415		580			1500
Z33M102S	1000(850 ~1150)		520	730	1725		620			1000

1. Operating temperature range: -40 to 85°C
2. Storage temperature range: -40 to 125°C

Dimensions



SURGE ABSORBER UNIT

The said unit is connected to line and ground, and protects an electric appliance from the surge influence. When the unit was broken by the surge of over rated current, it shows trouble in lighting LED. The socket of exclusive use for the unit, shown in right side figure, is also suppliable.

Specifications table SA series

Line voltage	Part No.	Rating voltage		Rating current	
		line-line	ground-line	line-line	ground-line
		V	V	A	A
48V DC	SA- 50V	65V _{DC}	180V _{DC} or 140V _{DC}	1250	1500
100V AC	SA-100V	140V _{AC}	240V _{AC}	1250	1250
200V AC	SA-200V	250V _{AC}	510V _{AC}	1250	1500
240V AC	SA-240V	300V _{AC}	510V _{AC}	1250	1500

Clamping voltage is measured by ()V peak voltage wave with line impedance of 50 Ω

Dimensions



Part No.	W	D	H
SA-50V, 100V	40 \pm 1	15 \pm 2	30 \pm 1
SA-200V, 240V	40 \pm 1	18 \pm 1	35 \pm 1

(mm)

Application

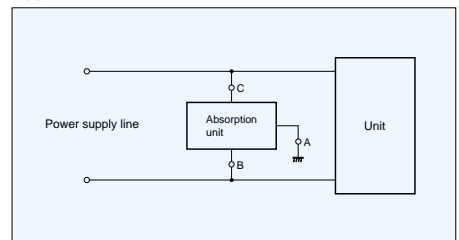

ZENAMIC

Reliability

Characteristics		Test Methods/Descriptions	Criterion																																					
Electrical	Standard Test Condition	Unless other wise specified, electrical measurements (initial/aftertests) shall be conducted at temperature of 5 to 35°C, relative humidity of 45 to 85% and atmospheric pressure of 860 to 1060 hPa.	To meet the specified value.																																					
	Varistor Voltage	The voltage between two terminals with the specified measuring current C_{mA} DC applied is called V_C or V_{CmA} . The measurement shall be made as fast as possible to avoid heat affection.																																						
	Maximum Allowable Voltage	The maximum sinusoidal RMS voltage or maximum DC voltage that can be applied continuously in the specified operating temperature range.																																						
	Clamping Voltage	The maximum voltage between two terminals with the specified standard impulse current (8/20 μ s) illustrated below applied. <div style="text-align: center;"> <p>The graph shows a standard impulse current waveform. The vertical axis is 'Current (%)' ranging from 0 to 100. The horizontal axis is 'Time' with markers at 8ms and 20ms. The curve starts at 0, rises to 100% at 8ms, and then decays, reaching 50% at 20ms.</p> </div>																																						
	Rated Power	The power that can be applied in the specified ambient temperature.																																						
	Maximum Energy	The maximum energy within the varistor voltage change of $\pm 10\%$ when a single impulse current of 2 ms or 10/1000 μ s is applied.																																						
	Maximum Peak Current (Withstanding Surge Current)	2 times		The maximum current within the varistor voltage change of $\pm 10\%$ when a standard impulse current of 8/20 μ s is applied two times with an interval of 5 minutes.																																				
		1 times		The maximum current within the varistor voltage change of $\pm 10\%$ with a single standard impulse current of 8/20 μ s is applied.																																				
	Temperature Coefficient of Varistor Voltage	$\frac{V_{CmA} \text{ at } 85^\circ\text{C} - V_{CmA} \text{ at } 25^\circ\text{C}}{V_{CmA} \text{ at } 25^\circ\text{C}} \times \frac{1}{60} \times 100 (\%/^\circ\text{C})$		0 to -0.05% / $^\circ\text{C}$ max.																																				
	Capacitance	Capacitance shall be measured at 1kHz $\pm 10\%$, 1Vrms max.(1MHz $\pm 10\%$ below 100pF), 0 V bias and $20 \pm 2^\circ\text{C}$		To meet the specified value																																				
	Withstanding Voltage (Body Insulation)	The specified voltage shall be applied between both terminals of the specimen connected together and metal foil closely wrapped round its body for 1 minute. <table border="1" style="margin-left: auto; margin-right: auto;"> <thead> <tr> <th>Classification(Nominal varistor voltage)</th> <th>Test voltage(AC)</th> </tr> </thead> <tbody> <tr> <td>$V_{0.1mA} \cdot V_{1mA} \leq 330V$</td> <td>1000 Vrms</td> </tr> <tr> <td>$V_{0.1mA} \cdot V_{1mA} > 330V$</td> <td>1500 Vrms</td> </tr> </tbody> </table>		Classification(Nominal varistor voltage)	Test voltage(AC)	$V_{0.1mA} \cdot V_{1mA} \leq 330V$	1000 Vrms	$V_{0.1mA} \cdot V_{1mA} > 330V$	1500 Vrms	No breakdown																														
	Classification(Nominal varistor voltage)	Test voltage(AC)																																						
$V_{0.1mA} \cdot V_{1mA} \leq 330V$	1000 Vrms																																							
$V_{0.1mA} \cdot V_{1mA} > 330V$	1500 Vrms																																							
Impulse Life	The change of V_{CmA} shall be measured after the impulse current listed below is applied 10000 or 100000 times continuously at intervals of 10 seconds at room temperature. <table border="1" style="margin-left: auto; margin-right: auto;"> <thead> <tr> <th rowspan="2">Part NO.</th> <th>Impulse Life(I)</th> <th>Impulse Life(II)</th> </tr> <tr> <th>$\times 10^4$ Times</th> <th>$\times 10^5$ Times</th> </tr> <tr> <th></th> <th colspan="2">impulse current (A)</th> </tr> </thead> <tbody> <tr> <td>Z 5D180 to Z 5D680</td> <td>8(8/20μs)</td> <td>5(8/20μs)</td> </tr> <tr> <td>Z 7D180 to Z 7D680</td> <td>25(8/20μs)</td> <td>15(8/20μs)</td> </tr> <tr> <td>Z10D180 to Z10D680</td> <td>50(8/20μs)</td> <td>35(8/20μs)</td> </tr> <tr> <td>Z15D180 to Z15D680</td> <td>90(8/20μs)</td> <td>50(8/20μs)</td> </tr> <tr> <td>Z21D180 to Z21D680</td> <td>130(8/20μs)</td> <td>65(8/20μs)</td> </tr> <tr> <td>Z 5D820 to Z 5D471</td> <td>40(8/20μs)</td> <td>25(8/20μs)</td> </tr> <tr> <td>Z 7D820 to Z 7D511</td> <td>100(8/20μs)</td> <td>60(8/20μs)</td> </tr> <tr> <td>Z10D820 to Z10D102</td> <td>150(8/20μs)</td> <td>85(8/20μs)</td> </tr> <tr> <td>Z15D820 to Z15D102</td> <td>200(8/20μs)</td> <td>110(8/20μs)</td> </tr> <tr> <td>Z21D820 to Z21D102</td> <td>250(8/20μs)</td> <td>120(8/20μs)</td> </tr> </tbody> </table>	Part NO.	Impulse Life(I)	Impulse Life(II)	$\times 10^4$ Times	$\times 10^5$ Times		impulse current (A)		Z 5D180 to Z 5D680	8(8/20 μ s)	5(8/20 μ s)	Z 7D180 to Z 7D680	25(8/20 μ s)	15(8/20 μ s)	Z10D180 to Z10D680	50(8/20 μ s)	35(8/20 μ s)	Z15D180 to Z15D680	90(8/20 μ s)	50(8/20 μ s)	Z21D180 to Z21D680	130(8/20 μ s)	65(8/20 μ s)	Z 5D820 to Z 5D471	40(8/20 μ s)	25(8/20 μ s)	Z 7D820 to Z 7D511	100(8/20 μ s)	60(8/20 μ s)	Z10D820 to Z10D102	150(8/20 μ s)	85(8/20 μ s)	Z15D820 to Z15D102	200(8/20 μ s)	110(8/20 μ s)	Z21D820 to Z21D102	250(8/20 μ s)	120(8/20 μ s)	$\Delta V_{CmA} / V_{CmA} \leq \pm 10\%$
Part NO.	Impulse Life(I)		Impulse Life(II)																																					
	$\times 10^4$ Times	$\times 10^5$ Times																																						
	impulse current (A)																																							
Z 5D180 to Z 5D680	8(8/20 μ s)	5(8/20 μ s)																																						
Z 7D180 to Z 7D680	25(8/20 μ s)	15(8/20 μ s)																																						
Z10D180 to Z10D680	50(8/20 μ s)	35(8/20 μ s)																																						
Z15D180 to Z15D680	90(8/20 μ s)	50(8/20 μ s)																																						
Z21D180 to Z21D680	130(8/20 μ s)	65(8/20 μ s)																																						
Z 5D820 to Z 5D471	40(8/20 μ s)	25(8/20 μ s)																																						
Z 7D820 to Z 7D511	100(8/20 μ s)	60(8/20 μ s)																																						
Z10D820 to Z10D102	150(8/20 μ s)	85(8/20 μ s)																																						
Z15D820 to Z15D102	200(8/20 μ s)	110(8/20 μ s)																																						
Z21D820 to Z21D102	250(8/20 μ s)	120(8/20 μ s)																																						

ZENAMIC

Reliability

Characteristics		Test Methods	Criterion															
Mechanical	Robustness of Terminations (Tensile)	<p>After gradual applying of the force specified below and keeping the unit fixed for 10 seconds, the terminal shall be visually examined for any damage.</p> <table border="1"> <thead> <tr> <th>Terminal diameter</th> <th>Force</th> </tr> </thead> <tbody> <tr> <td>φ0.6mm, φ0.8mm</td> <td>9.8N(1.0kgf)</td> </tr> <tr> <td>φ1.0mm</td> <td>19.6N(2.0kgf)</td> </tr> </tbody> </table>	Terminal diameter	Force	φ0.6mm, φ0.8mm	9.8N(1.0kgf)	φ1.0mm	19.6N(2.0kgf)	No remarkable mechanical damage									
	Terminal diameter	Force																
	φ0.6mm, φ0.8mm	9.8N(1.0kgf)																
	φ1.0mm	19.6N(2.0kgf)																
	Robustness of Terminations (Bending)	<p>The unit shall be secured with its terminal kept vertical and the force specified below shall be applied in the axial direction. The terminal shall gradually be bent by 90° in one direction, then 90° in the opposite direction, and again back to the original position. The damage of the terminal shall be visually examined.</p> <table border="1"> <thead> <tr> <th>Terminal diameter</th> <th>Force</th> </tr> </thead> <tbody> <tr> <td>φ 0.6mm, φ0.8mm</td> <td>4.9N(0.5kgf)</td> </tr> <tr> <td>φ1.0mm</td> <td>9.8N(1.0kgf)</td> </tr> </tbody> </table>	Terminal diameter	Force	φ 0.6mm, φ0.8mm	4.9N(0.5kgf)	φ1.0mm	9.8N(1.0kgf)										
Terminal diameter	Force																	
φ 0.6mm, φ0.8mm	4.9N(0.5kgf)																	
φ1.0mm	9.8N(1.0kgf)																	
Vibration	<p>After repeated applying of a single harmonic vibration (amplitude:0.75mm, double amplitude:1.5mm) with 1 minute vibration frequency cycle (10 Hz to 55 Hz to 10Hz) to each of three perpendicular directions for 2 hours. Thereafter, the unit shall be visually examined.</p>																	
Solderability	<p>After dipping the terminals to a depth of approximately 3 mm from the body in a soldering bath of 235±5°C for 2±0.5seconds, the terminal shall be visually examined.</p>	Approximately 95% of the terminals shall be covered uniformly with new solder																
Resistance to Soldering Heat	<p>After each lead shall be dipped into a solder bath of 260±5°C to a point 2.0 to 2.5mm from the body of the unit, using shielding board (t=1.5mm), be held there for 10±1s (5 series:5±1s) and then be stored at room temperature and normal humidity for 1 to 2 hours. The change of V_{CmA} and mechanical damage shall be examined.</p>	$\Delta V_{CmA}/V_{CmA} \leq \pm 5\%$ No remarkable mechanical damage																
Environmental	High Temperature Storage/Dry Heat	<p>The specimen shall be subjected to 125±2°C for 1000 hours in a thermostatic bath without load and then stored at room temperature and normal humidity for 1 to 2 hours. Thereafter, the change of V_{CmA} shall be measured.</p>	$\Delta V_{CmA}/V_{CmA} \leq \pm 5\%$															
	Humidity (Steady State)	<p>The specimen shall be subjected to 40±2°C, 90 to 95% RH for 1000 hours without load and then stored at room temperature and normal humidity for 1 to 2 hours. Thereafter, the change of V_{CmA} shall be measured.</p>	$\Delta V_{CmA}/V_{CmA} \leq \pm 5\%$															
	Temperature Cycle	<p>The following temperature cycle shall be repeated five times and then stored at room temperature and normal humidity for 1 to 2 hours. The change of V_{CmA} and mechanical damage shall be examined.</p> <table border="1"> <thead> <tr> <th>Step</th> <th>Temperature(°C)</th> <th>Period(minutes)</th> </tr> </thead> <tbody> <tr> <td>1</td> <td>-40±3</td> <td>30±3</td> </tr> <tr> <td>2</td> <td>Room temperature</td> <td>15±3</td> </tr> <tr> <td>3</td> <td>125±2</td> <td>30±3</td> </tr> <tr> <td>4</td> <td>Room temperature</td> <td>15±3</td> </tr> </tbody> </table>	Step	Temperature(°C)	Period(minutes)	1	-40±3	30±3	2	Room temperature	15±3	3	125±2	30±3	4	Room temperature	15±3	$\Delta V_{CmA}/V_{CmA} \leq \pm 5\%$ No remarkable mechanical damage
	Step	Temperature(°C)	Period(minutes)															
	1	-40±3	30±3															
	2	Room temperature	15±3															
3	125±2	30±3																
4	Room temperature	15±3																
High Temperature Load/ Dry Heat Load	<p>After being continuously applied the Maximum Allowable Voltage at 85±2°C for 1000 hours, the specimen shall be stored at room temperature and normal humidity for 1 to 2 hours. Thereafter, the change of V_{CmA} shall be measured.</p>	$\Delta V_{CmA}/V_{CmA} \leq \pm 10\%$																
Damp Heat Load/ Humidity Load	<p>The specimen shall be subjected to 40±2°C, 90 to 95% RH and the Maximum Allowable Voltage for 1000 hours and then stored at room temperature and normal humidity for 1 to 2 hours. Thereafter, the change of V_{CmA} shall be measured.</p>	$\Delta V_{CmA}/V_{CmA} \leq \pm 10\%$																
Low Temperature Storage/Cold	<p>The specimen shall be subjected to -40±2°C without load for 1000 hours and then stored at room temperature and normal humidity for 1 to 2 hours. Thereafter, the change of V_{CmA} shall be measured.</p>	$\Delta V_{CmA}/V_{CmA} \leq \pm 5\%$																

GASTUBE ARRESTER

Gas tube arrester(GTA)is a surge absorber featuring low capacitance and high surge absorption energy.

It consists of a sealed tube in which inert gas is injected and electrodes which are set at fixed intervals. The simple structure and the dimensional accuracy offer high reliability and stabilized characteristics.

Applications

1. Protection for telephone set, facsimile, telex, telephone system, CATV, computer and peripheral equipment.
2. Semiconductor circuit protection in equipment that also uses high voltage such as TV, oscilloscope, and electron microscope.
3. Automatic control of luminous energy in stroboscopic tube.
4. Generator of high-voltage for gas igniter.

Voltage-Current Characteristics

The current through the GTA is changed over the range of values of 10^{-18} to 10^2 amps which is shown as the figure below and the voltage across the GTA will also vary. The discharge characteristics are changed to various mode by the flowing current, and the final mode of the discharge characteristics is arc discharge .

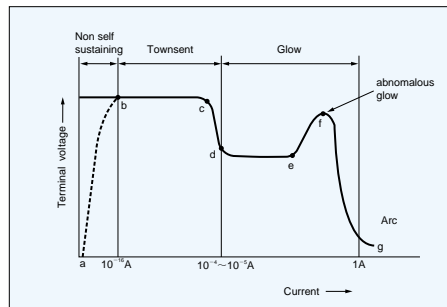

When the applied voltage across the GTA exceeds the breakdown voltage (sparkover voltage), the current through the GTA increases rapidly to value of several amps or greater. The rate of current rise and level to be reached are limited by the series impedance of the circuit. The voltage across the GTA at this time is very low with typical value of 20 to 30 volts.

Electrical Characteristics

AC Discharge Current

The current is the rms value of sinusoidal alternating current of 50Hz or 60Hz which can flow through the GTA in accordance with a certain test method without substantially altering its sparkover voltage. The usual test consists of specified loads applied for 1 sec at interval of 1 min alternately. In the test of the maximum AC discharge current, the GTA is applied 9 cycles of 50Hz AC(180 ms) continuously.

Impulse Surge Life

The life is defined as the minimum number of surges of a certain current waveform the GTA can survive without deterioration of its operating specifications.

Insulation Resistance

This is defined as the resistance value across the terminal of GTA at 100V_{DC} for devices over 230V_{DC} (140V_{DC} for GTA type) breakdown voltage and 50V_{DC} for devices less than 230V_{DC}(140V_{DC} for GTA type) ratings.

DC Breakdown Voltage

The voltage is the minimum slowly rising DC voltage that will cause sparkover when applied across the terminal of the GTA. The GTA shall be placed in darkness for at least 15 min and tested in this condition using a ramp voltage waveform with 100V/s to 500V/s.

The GTA shall be tested with a positive and a negative waveform. The sparkover current for DC sparkover voltage test shall be within 10 amps.

Impulse Breakdown Voltage

The GTA to be exposed to the test shall be kept in total darkness before (for at least 15 min) and during the test. Then, with a ramp voltage with 5kV/ μ s applied to the GTA, the breakdown voltage level is recorded. In case of testing with opposite polarity, using the same GTA, a minimum of 15 min shall elapse.

Maximum Single Impulse Discharge Current

This test is to determine the ability of the GTA to conduct a maximum single impulse Discharge current. The current impulse waveform is 8/20 μ s. The maximum single impulse discharge current is the crest current of the impulse.

Capacitance

The capacitance of the GTA is defined as capacitance across terminals of the GTA at 1 kHz.

Operating Temperature Range

-20°C~65°C

DC Holdover Voltage

This values is defined as the maximum DC voltage across the terminals of the GTA which is expected to clear and restore its high impedance state within 150 ms or less after the passage of a surge.

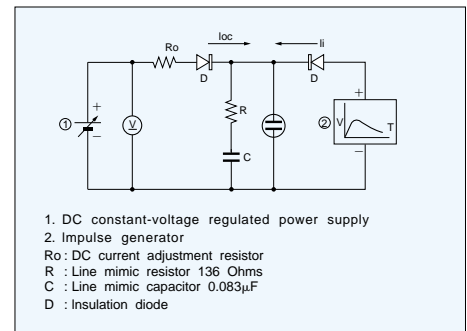

Impulse Waveform

Impulse breakdown voltage is the voltage at which the GTA fires when the voltage increases at rates of more than 100V/ μ s. This value may not vary even after the GTA has been stored in the dark for long period. The value of the impulse breakdown voltage increases with increasing steepness of the surge voltage as the figure below.

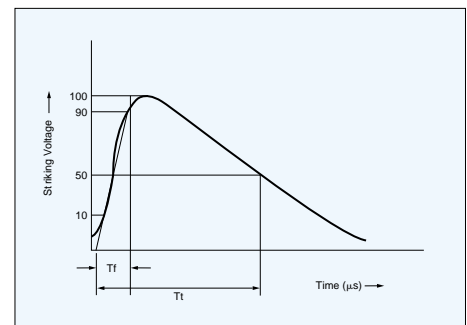

GTA3P type

Dimensions

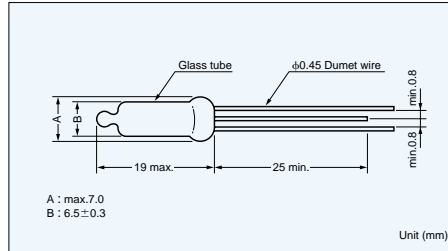

V-t Characteristics

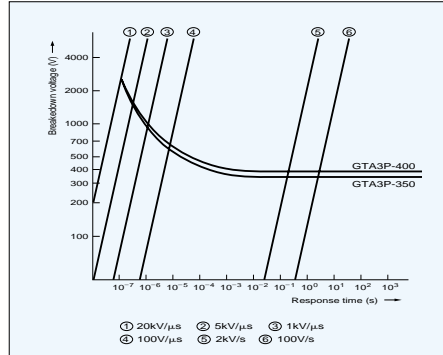

Specifications

Part No.	DC Breakdown Voltage (100V/s)	Impulse Breakdown Voltage (5kV/μs)	Maximum Single Impulse Discharge Current (8/20μs)	Impulse Life (8/20μs)	Insulation Resistance (DC100V)	Capacitance (1kHz)
GTA3P-350	350V ± 15%	1600V max.	1500A × 1 time	350A × 1000 times	10 ⁴ MΩ min	1pF max.
GTA3P-400	400V ± 15%	1600V max.				

CM2P, CM3P type

A ceramic tube is sealed at both side by electrodes, and inside of it is filled up by inert gas. The ceramic type gas tube arrester has superior characteristics

such as mechanical strength, surge absorption energy and stability. There are two electrodes type and three electrodes type.

Dimensions

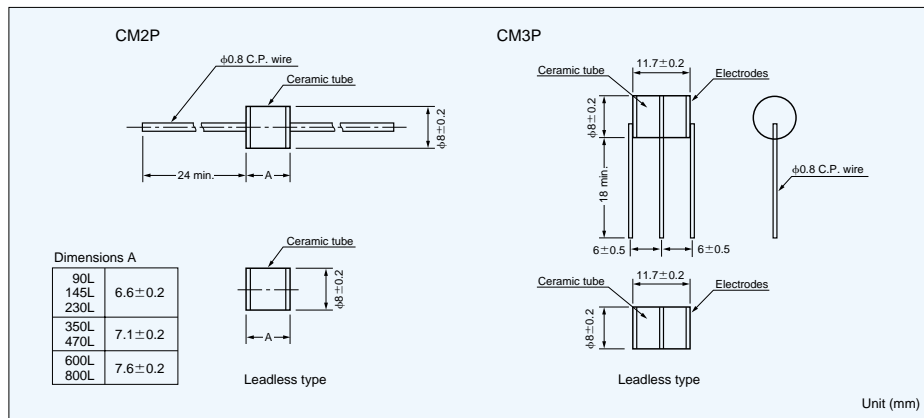

Specifications

Part No.	DC Breakdown Voltage (100V/s)	Impulse Breakdown Voltage (5kV/μs)	Maximum Single Impulse Discharge Current (8/20μs)	Impulse Life (10/1000μs)	Insulation Resistance (DC100V or 50V)	Capacitance (1kHz)
CM2P-90L	90V ± 20%	1000V max.	10000A × 2 times	500A × 600 times	10 ⁴ MΩ min.	2pF max.
CM2P-145L	145V ± 20%	1000V max.	10000A × 2 times	500A × 600 times	10 ⁴ MΩ min.	2pF max.
CM2P-230L	230V ± 15%	1000V max.	10000A × 2 times	500A × 600 times	10 ⁴ MΩ min.	2pF max.
CM2P-350L	350V ± 15%	1500V max.	10000A × 2 times	500A × 600 times	10 ⁴ MΩ min.	2pF max.
CM2P-470L	470V ± 15%	1500V max.	10000A × 2 times	500A × 600 times	10 ⁴ MΩ min.	2pF max.
CM2P-600L	600V ± 15%	1800V max.	10000A × 2 times	500A × 600 times	10 ⁴ MΩ min.	2pF max.
CM2P-800L	800V ± 15%	2000V max.	10000A × 2 times	500A × 600 times	10 ⁴ MΩ min.	2pF max.
CM3P-230L	230V ± 20%	1000V max.	10000A × 2 times	500A × 600 times	10 ⁴ MΩ min.	2pF max.
CM3P-350L	350V ± 20%	1200V max.	10000A × 2 times	500A × 600 times	10 ⁴ MΩ min.	2pF max.
CM3P-400L	400V ± 20%	1200V max.	10000A × 2 times	500A × 600 times	10 ⁴ MΩ min.	2pF max.

● Suffix : L shows lead type and no-suffix shows leadless type



V-t Characteristics



M2P type

A glass tube is sealed at both side by electrodes, and inside of it is filled up by inert gas.

Dimensions



Dimension A						
M2P-90L	M2P-145L	M2P-230L	M2P-350L	M2P-470L	M2P-600L	M2P-800L
6.1±0.2	6.1±0.2	6.6±0.3	6.6±0.3	6.6±0.3	6.6±0.3	7.6±0.3

Unit (mm)

V-t Characteristics



Specifications

Part No.	DC Breakdown Voltage (100V/s)	Impulse Breakdown Voltage (5kV/μs)	Maximum Single Impulse Discharge Current (8/20μs)	Impulse Life (10/1000μs)	Insulation Resistance (DC 100V or 50V)	Capacitance (1kHz)
M2P-90L	90V ±20%	1000V max.	3000A ×2 times	500A ×100 times	10 ⁴ MΩ min.	2pF max.
M2P-145L	145V ±20%	1000V max.	3000A ×2 times	500A ×100 times	10 ⁴ MΩ min.	2pF max.
M2P-230L	230V ±15%	1000V max.	3000A ×2 times	500A ×100 times	10 ⁴ MΩ min.	2pF max.
M2P-350L	350V ±15%	1500V max.	3000A ×2 times	500A ×100 times	10 ⁴ MΩ min.	2pF max.
M2P-470L	470V ±15%	1500V max.	3000A ×2 times	500A ×100 times	10 ⁴ MΩ min.	2pF max.
M2P-600L	600V ±15%	2500V max.	3000A ×2 times	500A ×100 times	10 ⁴ MΩ min.	2pF max.
M2P-800L	800V ±15%	2500V max.	3000A ×2 times	500A ×100 times	10 ⁴ MΩ min.	2pF max.

● Suffix : shows lead type and no-suffix shows leadless type

GTA type

Electrodes are set in a sealed glass, and inert gas is filled inside.

Dimensions

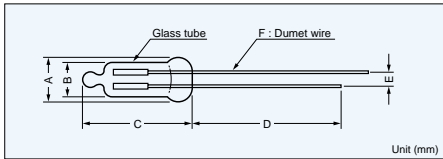

	GTA-80D~GTA-500D	GTA-750D,800D
A	6.4max.	7.0max.
B	φ5.85 ±0.3	φ6.5 ±0.3
C	19max	19max
D	25min.	25min.
E	3min.	3min.
F	φ0.45	φ0.45

Unit (mm)

V-t Characteristics

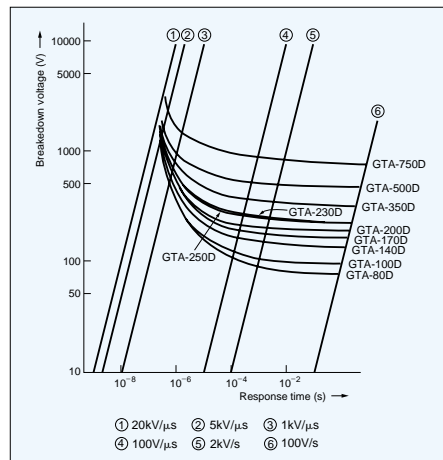

Specifications

Part No.	DC Breakdown Voltage (100V/s)	Impulse Breakdown Voltage (5kV/μs)	Maximum Single Impulse Discharge Current (8/20μs)	Impulse Life (8/20μs)	Insulation Resistance (DC 100V or 50V)	Capacitance (1kHz)
GTA-80D	80V ±15%	1200V max.	1500A ×1 time	500A ×1000 times	10 ⁴ MΩ min.	2pF max.
GTA-100D	100V ±15%	1300V max.	1500A ×1 time	500A ×1000 times	10 ⁴ MΩ min.	2pF max.
GTA-140D	140V ±15%	1300V max.	1500A ×1 time	500A ×1000 times	10 ⁴ MΩ min.	2pF max.
GTA-170D	170V ±15%	1500V max.	1500A ×1 time	500A ×1000 times	10 ⁴ MΩ min.	2pF max.
GTA-200D	200V ±15%	1700V max.	1500A ×1 time	500A ×1000 times	10 ⁴ MΩ min.	2pF max.
GTA-230D	230V ±15%	1700V max.	1500A ×1 time	500A ×1000 times	10 ⁴ MΩ min.	2pF max.
GTA-250D	250V ±15%	1700V max.	1500A ×1 time	500A ×1000 times	10 ⁴ MΩ min.	2pF max.
GTA-350D	350V ±15%	2000V max.	1500A ×1 time	500A ×1000 times	10 ⁴ MΩ min.	2pF max.
GTA-500D	500V ±15%	2100V max.	1500A ×1 time	500A ×1000 times	10 ⁴ MΩ min.	2pF max.
GTA-750D	750V ±15%	4500V max.	1500A ×1 time	500A ×1000 times	10 ⁴ MΩ min.	2pF max.
GTA-800D	800V ±15%	5000V max.	1500A ×1 time	500A ×1000 times	10 ⁴ MΩ min.	2pF max.

SA01 type

The SA01 is a new product which can be utilized for protecting transient voltage in power supply of equipment with earth terminal.

For the equipment in which SA01 is used, the AC withstanding voltage between power lines and earth terminal can be tested without taking off "SA01".

Dimensions

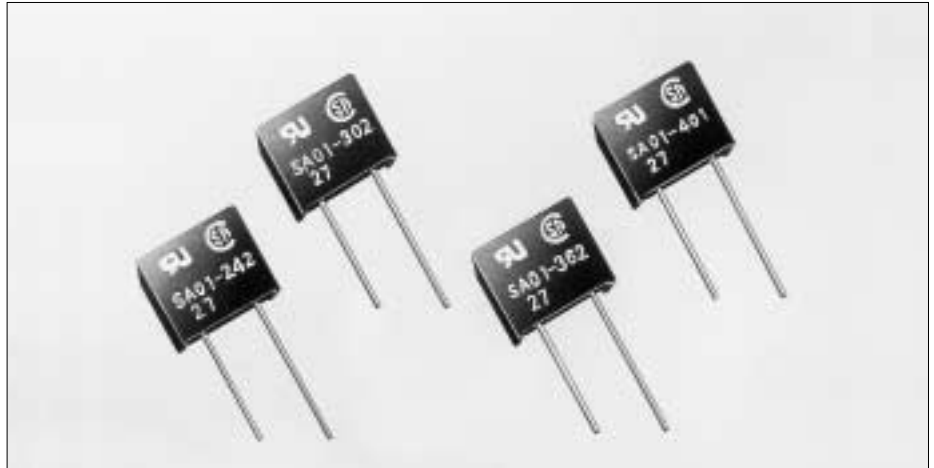
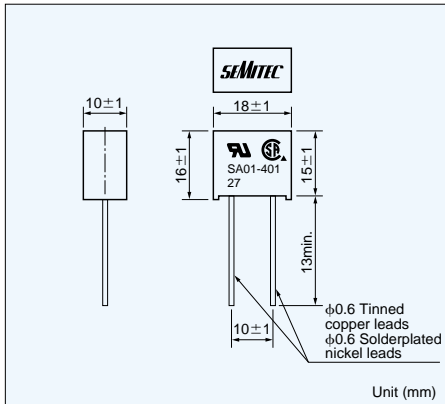

Safety Standards

Standards Name	UL	CSA	TÜV
Standards No.	UL1449	C22.2 No.1	IEC61051
File No.	E128417	LR-76099	J500/5463
Mark			—

Specifications

Part No.	DC Breakdown Voltage (100V/s)	Impulse Breakdown Voltage (5kV/μs)	Maximum Single Impulse Discharge Current (8/20μs)	Impulse Life (8/20μs)	Insulation Resistance (DC100V)	Capacitance (1kHz)	Connection	Dielectric Withstanding Voltage
SA01-401	400V $\pm 20\%$	1000V max.	1250A×2 times	100A×300 times	10 ² MΩ min	2pF max.	AC125V (Line-Line)	—
SA01-501	500V $\pm 20\%$	1400V max.	1250A×2 times	100A×300 times	10 ² MΩ min	2pF max.	AC250V (Line-Line)	—
SA01-242	2400V $\pm 20\%$	4000V max.	1250A×2 times	100A×300 times	10 ² MΩ min	2pF max.	AC125V (Line-GND)	AC1200V 3s
SA01-302	3000V $\pm 20\%$	4500V max.	1250A×2 times	100A×300 times	10 ² MΩ min	2pF max.	AC250V (Line-GND)	AC1500V 1min
SA01-362	3600V $\pm 20\%$	5000V max.	1250A×2 times	100A×300 times	10 ² MΩ min	2pF max.	AC250V (Line-GND)	AC1800V 3s

Application Circuit

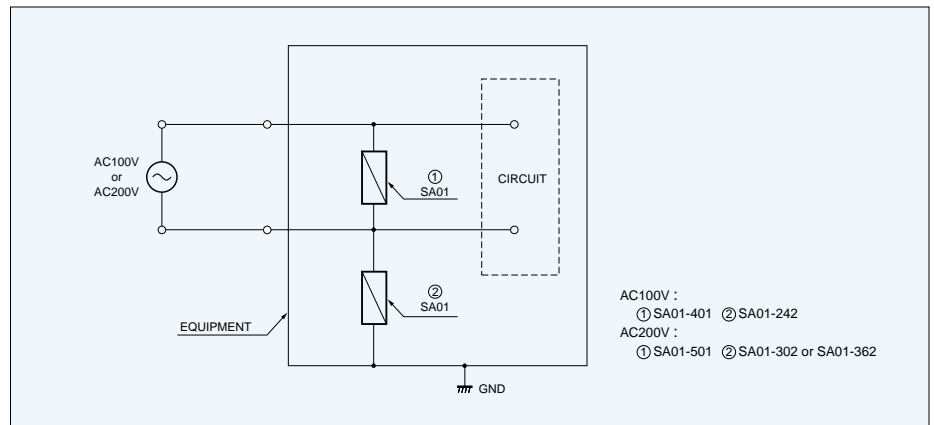

WARRANTY

The manufacturer hereby warrants, that it will replace this product or any part thereof which shall prove to be defective in workmanship or material, subject to the following limitations:

- (1) This is only for the benefit of the original purchaser and to no other person, company or individual.
- (2) This warranty does not apply to defects caused by improper installation.
- (3) This warranty is limited to the replacement of the defective product, or part thereof, and does not include any labor costs for installation or removal of the product.
- (4) The manufacturer shall not be liable for indirect, consequential or special damages and is limited solely to replacement of the product.

If the product or any part thereof shall prove to be defective in workmanship or material, the original purchaser shall ship the product to the manufacturer in the original packing carton, together with a copy of the original sales receipt for the product, and, if in the opinion of the manufacturer, the product proves to be defective in workmanship or material, the sole obligation of the manufacturer shall be the replacement of the defective product or part thereof. Shipping charges to the manufacturer is the obligation of the original purchaser.

This limited warranty is in lieu of and replaces all of the warranties previously given by the manufacturer, both express and implied, including any warranties of merchantability or fitness for a particular purpose. There are no warranties which extend beyond the face hereof.

No lawsuit may be commenced against the manufacturer unless the original consumer purchaser has complied with all of the terms and conditions of this warranty and the manufacturer has refused to comply therewith.

ISO9002 ISO14001 Certified

SEMITEC®

Ishizuka Electronics Corporation

HEAD OFFICE:7-7, Kinshi 1-Chome, Sumida-ku, Tokyo, 130-8512 Japan

TEL:81-3-3621-2704 FAX:81-3-3623-6815

E-mail : overseas@mail.semitec.co.jp

SEMITEC GROUP

USA:SEMITEC USA CORP.	TEL:1-631-587-4086 FAX:1-631-321-9604 E-mail : sales@semitec-usa.com
HONG KONG:SEMITEC(H.K.)CO.,LTD.	TEL:852-2369-6773 FAX:852-2739-2396 E-mail : semihk@netvigator.com
TAIWAN:SEMITEC TAIWAN CORP.	TEL:886-2-2509-9855 FAX:886-2-2509-9599 E-mail : semitec@ms24.hinet.net
UK:ATC SEMITEC LTD.	TEL:44-1565-750538 FAX:44-1565-652396 E-mail : sales@atcsemitec.co.uk
KOREA:SEMITEC KOREA CO.,LTD.	TEL:82-2-3281-1155 FAX:82-2-3281-3338 E-mail : semitec@kornet.net
CHINA:SEMITEC SHANGHAI OFFICE	TEL:86-21-53086000 FAX:86-21-33040188 E-mail : xsgsxh@public.tz.js.cn

Visit us on the Web at <http://www.semitec.co.jp/>



Компания «ЭлектроПласт» предлагает заключение долгосрочных отношений при поставках импортных электронных компонентов на взаимовыгодных условиях!

Наши преимущества:

- Оперативные поставки широкого спектра электронных компонентов отечественного и импортного производства напрямую от производителей и с крупнейших мировых складов;
- Поставка более 17-ти миллионов наименований электронных компонентов;
- Поставка сложных, дефицитных, либо снятых с производства позиций;
- Оперативные сроки поставки под заказ (от 5 рабочих дней);
- Экспресс доставка в любую точку России;
- Техническая поддержка проекта, помощь в подборе аналогов, поставка прототипов;
- Система менеджмента качества сертифицирована по Международному стандарту ISO 9001;
- Лицензия ФСБ на осуществление работ с использованием сведений, составляющих государственную тайну;
- Поставка специализированных компонентов (Xilinx, Altera, Analog Devices, Intersil, Interpoint, Microsemi, Aeroflex, Peregrine, Syfer, Eurofarad, Texas Instrument, Miteq, Cobham, E2V, MA-COM, Hittite, Mini-Circuits, General Dynamics и др.);

Помимо этого, одним из направлений компании «ЭлектроПласт» является направление «Источники питания». Мы предлагаем Вам помощь Конструкторского отдела:

- Подбор оптимального решения, техническое обоснование при выборе компонента;
- Подбор аналогов;
- Консультации по применению компонента;
- Поставка образцов и прототипов;
- Техническая поддержка проекта;
- Защита от снятия компонента с производства.



Как с нами связаться

Телефон: 8 (812) 309 58 32 (многоканальный)

Факс: 8 (812) 320-02-42

Электронная почта: org@eplast1.ru

Адрес: 198099, г. Санкт-Петербург, ул. Калинина, дом 2, корпус 4, литера А.