

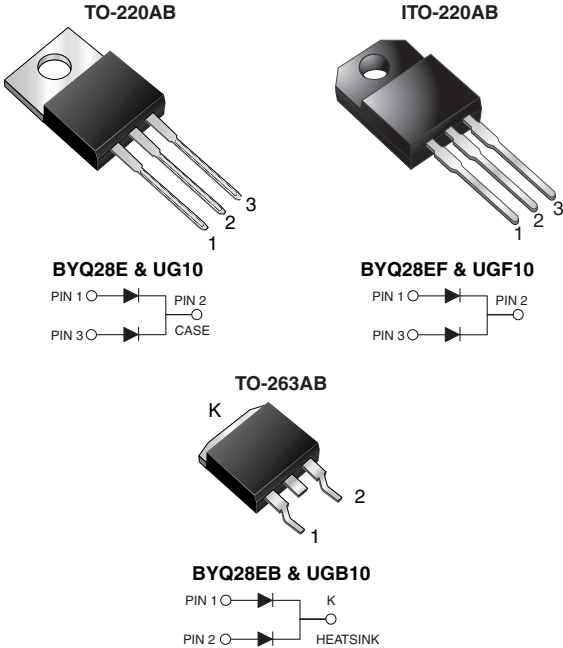

## Dual Common Cathode Ultrafast Rectifier



### FEATURES

- Glass passivated chip junction
- Ultrafast recovery times
- Soft recovery characteristics
- Low switching losses, high efficiency
- High forward surge capability
- Meets MSL level 1, per J-STD-020, LF maximum peak of 245 °C (for TO-263AB package)
- Solder dip 260 °C, 40 s (for TO-220AB and ITO-220AB package)
- Component in accordance to RoHS 2002/95/EC and WEEE 2002/96/EC



**RoHS**  
COMPLIANT

### TYPICAL APPLICATIONS

For use in low voltage, high frequency rectifier of switching power supplies, freewheeling diodes, dc-to-dc converters and polarity protection application.

### MECHANICAL DATA

**Case:** TO-220AB, ITO-220AB, TO-263AB

Epoxy meets UL 94V-0 flammability rating

**Terminals:** Matte tin plated leads, solderable per J-STD-002 and JESD22-B102

E3 suffix for consumer grade, meets JESD 201 class 1A whisker test, HE3 suffix for high reliability grade (AEC Q101 qualified), meets JESD 201 class 2 whisker test

**Polarity:** As marked

**Mounting Torque:** 10 in-lbs maximum

### PRIMARY CHARACTERISTICS

$I_{F(AV)}$	5 A x 2
$V_{RRM}$	100 V, 150 V, 200 V
$I_{FSM}$	55 A
$t_{rr}$	25 ns
$V_F$	0.895 V
$T_J$ max.	150 °C

### MAXIMUM RATINGS ( $T_C = 25$ °C unless otherwise noted)

PARAMETER	SYMBOL	UG10BCT	UG10CCT	UG10DCT	UNIT
		BYQ28E-100	BYQ28E-150	BYQ28E-200	
Maximum repetitive peak reverse voltage	$V_{RRM}$	100	150	200	V
Working peak reverse voltage	$V_{RWM}$	100	150	200	V
Maximum DC blocking voltage	$V_{DC}$	100	150	200	V
Maximum average forward rectified current at $T_C = 100$ °C total device per diode	$I_{F(AV)}$	10 5			A
Peak forward surge current 8.3 ms single half sine-wave superimposed on rated load per diode	$I_{FSM}$	55			A
Non-repetitive peak reverse current per diode at $t_p = 100$ $\mu$ s	$I_{RSM}$	0.2			A
Electrostatic discharge capacitor voltage, human body model: C = 250 pF, R = 1.5 k $\Omega$	$V_C$	8			kV
Operating junction and storage temperature range	$T_J, T_{STG}$	- 40 to + 150			°C
Isolation voltage (ITO-220AB only) from terminal to heatsink $t = 1$ min	$V_{AC}$	1500			V

# BYQ28E(F,B)-100 thru BYQ28E(F,B)-200, UG(F,B)10BCT

Vishay General Semiconductor



<b>ELECTRICAL CHARACTERISTICS</b> ( $T_C = 25\text{ }^\circ\text{C}$ unless otherwise noted)					
PARAMETER	TEST CONDITIONS		SYMBOL	VALUE	UNIT
Maximum instantaneous forward voltage per diode <sup>(1)</sup>	$I_F = 10\text{ A}$	$T_J = 25\text{ }^\circ\text{C}$	$V_F$	1.25	V
	$I_F = 5\text{ A}$	$T_J = 25\text{ }^\circ\text{C}$		1.10	
	$I_F = 5\text{ A}$	$T_J = 150\text{ }^\circ\text{C}$		0.895	
Maximum reverse current per diode at working peak reverse voltage		$T_J = 25\text{ }^\circ\text{C}$ $T_J = 100\text{ }^\circ\text{C}$	$I_R$	10 200	$\mu\text{A}$
Maximum reverse recovery time per diode	$I_F = 1.0\text{ A}$ , $dI/dt = 100\text{ A}/\mu\text{s}$ , $V_R = 30\text{ V}$ , $I_{rr} = 0.1 I_{RM}$		$t_{rr}$	25	ns
Maximum reverse recovery time per diode	$I_F = 0.5\text{ A}$ , $I_R = 1.0\text{ A}$ , $I_{rr} = 0.25\text{ A}$		$t_{rr}$	20	ns
Maximum stored charge per diode	$I_F = 2\text{ A}$ , $dI/dt = 20\text{ A}/\mu\text{s}$ , $V_R = 30\text{ V}$ , $I_{rr} = 0.1 I_{RM}$		$Q_{rr}$	9	nC

**Note:**

(1) Pulse test: 300  $\mu\text{s}$  pulse width, 1 % duty cycle

<b>THERMAL CHARACTERISTICS</b> ( $T_C = 25\text{ }^\circ\text{C}$ unless otherwise noted)					
PARAMETER	SYMBOL	UG10	UGF10	UGB10	UNIT
		BYQ28E	BYQ28EF	BYQ28EB	
Typical thermal resistance per diode, junction to ambient	$R_{\theta JA}$	50	55	50	$^\circ\text{C}/\text{W}$
Typical thermal resistance per diode, junction to case	$R_{\theta JC}$	4.5	6.7	4.8	

<b>ORDERING INFORMATION</b> (Example)					
PACKAGE	PREFERRED P/N	UNIT WEIGHT (g)	PACKAGE CODE	BASE QUANTITY	DELIVERY MODE
TO-220AB	BYQ28E-200-E3/45	1.80	45	50/tube	Tube
ITO-220AB	BYQ28EF-200-E3/45	1.95	45	50/tube	Tube
TO-263AB	BYQ28EB-200-E3/45	1.77	45	50/tube	Tube
TO-263AB	BYQ28EB-200-E3/81	1.77	81	800/reel	Tape reel
TO-220AB	BYQ28E-200HE3/45 <sup>(1)</sup>	1.80	45	50/tube	Tube
ITO-220AB	BYQ28EF-200HE3/45 <sup>(1)</sup>	1.95	45	50/tube	Tube
TO-263AB	BYQ28EB-200HE3/45 <sup>(1)</sup>	1.77	45	50/tube	Tube
TO-263AB	BYQ28EB-200HE3/81 <sup>(1)</sup>	1.77	81	800/reel	Tape reel

**Note:**

(1) Automotive grade AEC Q101 qualified



**RATINGS AND CHARACTERISTICS CURVES**

( $T_A = 25\text{ }^\circ\text{C}$  unless otherwise noted)

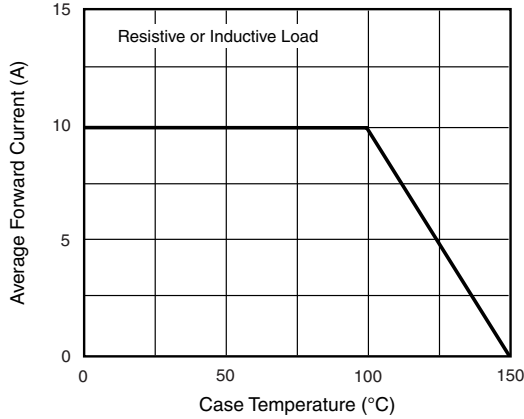

Figure 1. Forward Current Derating Curve

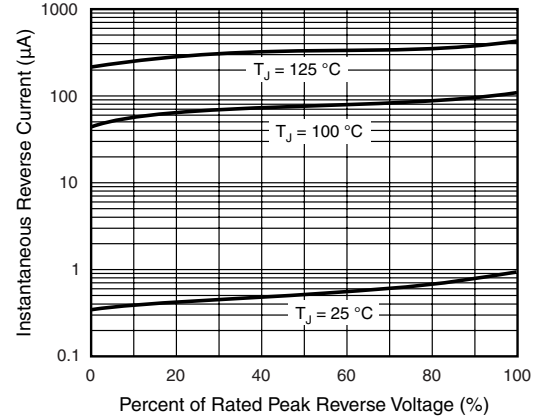

Figure 4. Typical Reverse Characteristics Per Diode

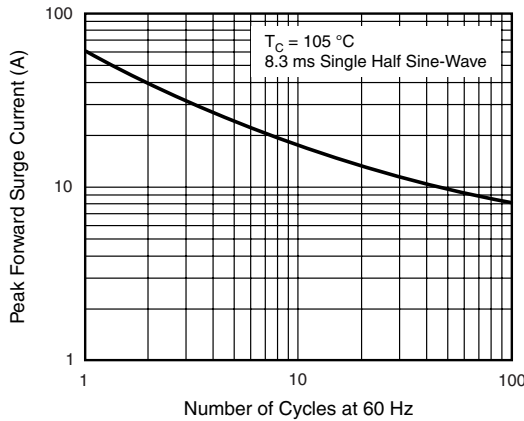

Figure 2. Maximum Non-Repetitive Peak Forward Surge Current Per Diode

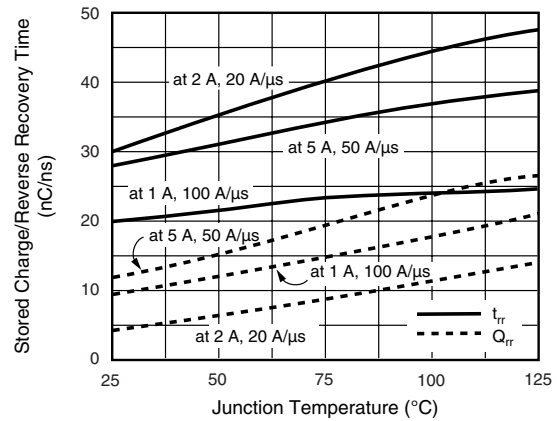

Figure 5. Reverse Switching Characteristics Per Diode

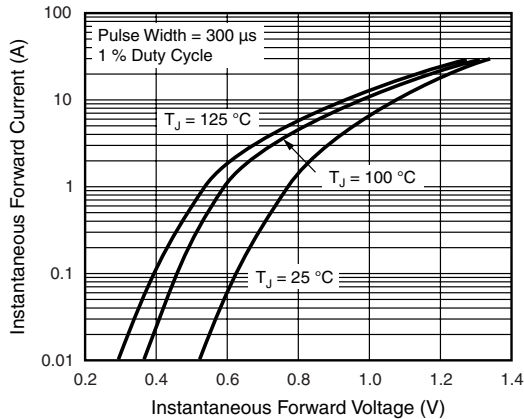

Figure 3. Typical Instantaneous Forward Characteristics Per Diode

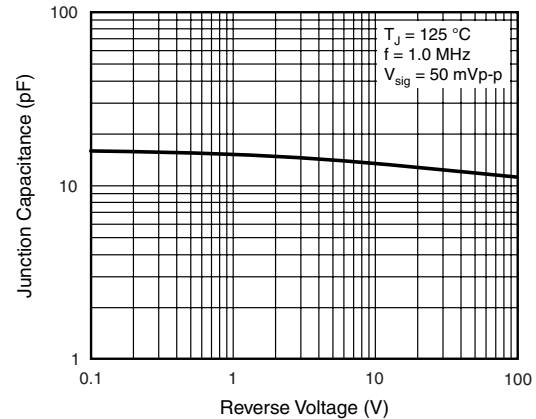

Figure 6. Typical Junction Capacitance Per Diode

# BYQ28E(F,B)-100 thru BYQ28E(F,B)-200, UG(F,B)10BCT

Vishay General Semiconductor



## PACKAGE OUTLINE DIMENSIONS in inches (millimeters)

**TO-220AB**

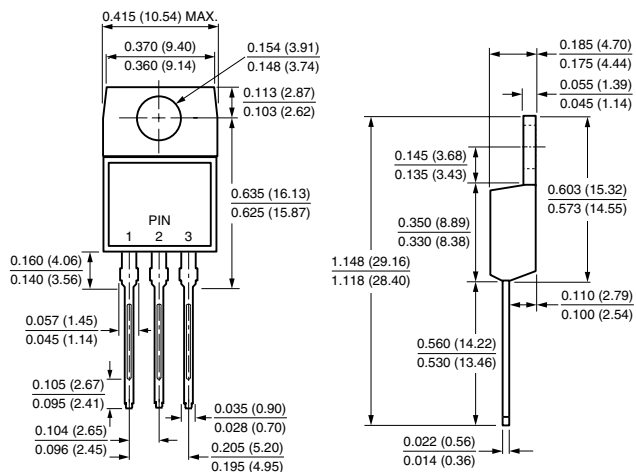

**ITO-220AB**

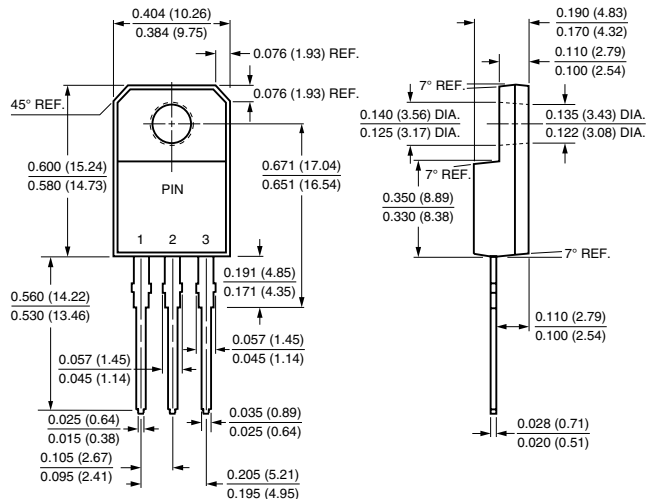

**TO-263AB**

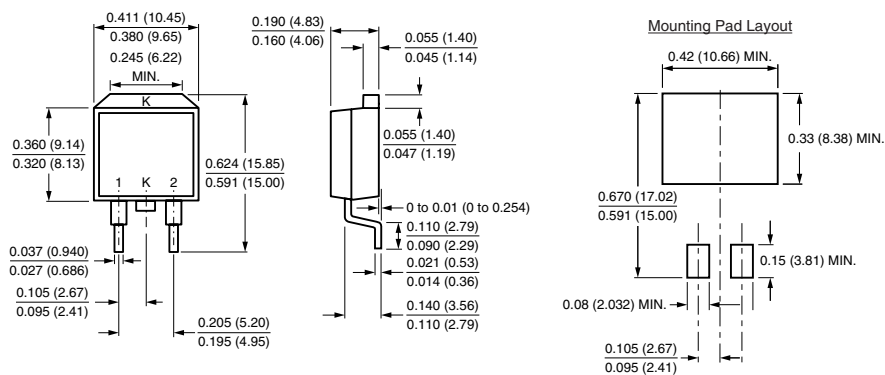



## Disclaimer

ALL PRODUCT, PRODUCT SPECIFICATIONS AND DATA ARE SUBJECT TO CHANGE WITHOUT NOTICE TO IMPROVE RELIABILITY, FUNCTION OR DESIGN OR OTHERWISE.

Vishay Intertechnology, Inc., its affiliates, agents, and employees, and all persons acting on its or their behalf (collectively, "Vishay"), disclaim any and all liability for any errors, inaccuracies or incompleteness contained in any datasheet or in any other disclosure relating to any product.

Vishay makes no warranty, representation or guarantee regarding the suitability of the products for any particular purpose or the continuing production of any product. To the maximum extent permitted by applicable law, Vishay disclaims (i) any and all liability arising out of the application or use of any product, (ii) any and all liability, including without limitation special, consequential or incidental damages, and (iii) any and all implied warranties, including warranties of fitness for particular purpose, non-infringement and merchantability.

Statements regarding the suitability of products for certain types of applications are based on Vishay's knowledge of typical requirements that are often placed on Vishay products in generic applications. Such statements are not binding statements about the suitability of products for a particular application. It is the customer's responsibility to validate that a particular product with the properties described in the product specification is suitable for use in a particular application. Parameters provided in datasheets and/or specifications may vary in different applications and performance may vary over time. All operating parameters, including typical parameters, must be validated for each customer application by the customer's technical experts. Product specifications do not expand or otherwise modify Vishay's terms and conditions of purchase, including but not limited to the warranty expressed therein.

Except as expressly indicated in writing, Vishay products are not designed for use in medical, life-saving, or life-sustaining applications or for any other application in which the failure of the Vishay product could result in personal injury or death. Customers using or selling Vishay products not expressly indicated for use in such applications do so at their own risk and agree to fully indemnify and hold Vishay and its distributors harmless from and against any and all claims, liabilities, expenses and damages arising or resulting in connection with such use or sale, including attorneys fees, even if such claim alleges that Vishay or its distributor was negligent regarding the design or manufacture of the part. Please contact authorized Vishay personnel to obtain written terms and conditions regarding products designed for such applications.

No license, express or implied, by estoppel or otherwise, to any intellectual property rights is granted by this document or by any conduct of Vishay. Product names and markings noted herein may be trademarks of their respective owners.

## Material Category Policy

**Vishay Intertechnology, Inc. hereby certifies that all its products that are identified as RoHS-Compliant fulfill the definitions and restrictions defined under Directive 2011/65/EU of The European Parliament and of the Council of June 8, 2011 on the restriction of the use of certain hazardous substances in electrical and electronic equipment (EEE) - recast, unless otherwise specified as non-compliant.**

**Please note that some Vishay documentation may still make reference to RoHS Directive 2002/95/EC. We confirm that all the products identified as being compliant to Directive 2002/95/EC conform to Directive 2011/65/EU.**



Компания «ЭлектроПласт» предлагает заключение долгосрочных отношений при поставках импортных электронных компонентов на взаимовыгодных условиях!

Наши преимущества:

- Оперативные поставки широкого спектра электронных компонентов отечественного и импортного производства напрямую от производителей и с крупнейших мировых складов;
- Поставка более 17-ти миллионов наименований электронных компонентов;
- Поставка сложных, дефицитных, либо снятых с производства позиций;
- Оперативные сроки поставки под заказ (от 5 рабочих дней);
- Экспресс доставка в любую точку России;
- Техническая поддержка проекта, помощь в подборе аналогов, поставка прототипов;
- Система менеджмента качества сертифицирована по Международному стандарту ISO 9001;
- Лицензия ФСБ на осуществление работ с использованием сведений, составляющих государственную тайну;
- Поставка специализированных компонентов (Xilinx, Altera, Analog Devices, Intersil, Interpoint, Microsemi, Aeroflex, Peregrine, Syfer, Eurofarad, Texas Instrument, Miteq, Cobham, E2V, MA-COM, Hittite, Mini-Circuits, General Dynamics и др.);

Помимо этого, одним из направлений компании «ЭлектроПласт» является направление «Источники питания». Мы предлагаем Вам помощь Конструкторского отдела:

- Подбор оптимального решения, техническое обоснование при выборе компонента;
- Подбор аналогов;
- Консультации по применению компонента;
- Поставка образцов и прототипов;
- Техническая поддержка проекта;
- Защита от снятия компонента с производства.



#### Как с нами связаться

**Телефон:** 8 (812) 309 58 32 (многоканальный)

**Факс:** 8 (812) 320-02-42

**Электронная почта:** [org@eplast1.ru](mailto:org@eplast1.ru)

**Адрес:** 198099, г. Санкт-Петербург, ул. Калинина, дом 2, корпус 4, литера А.