

●Features

- Ultra compact and thin 2-color type LED 1.0×1.0, t=0.2mm
- Low height contributes to the improvement of color mixture

●Size

1010 (0404)
1.0 × 1.0mm (t=0.2mm)



●Outline

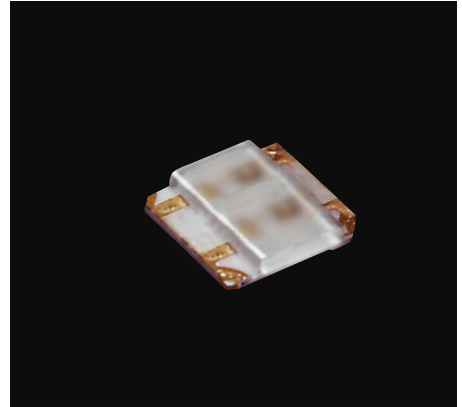

●Dimensions

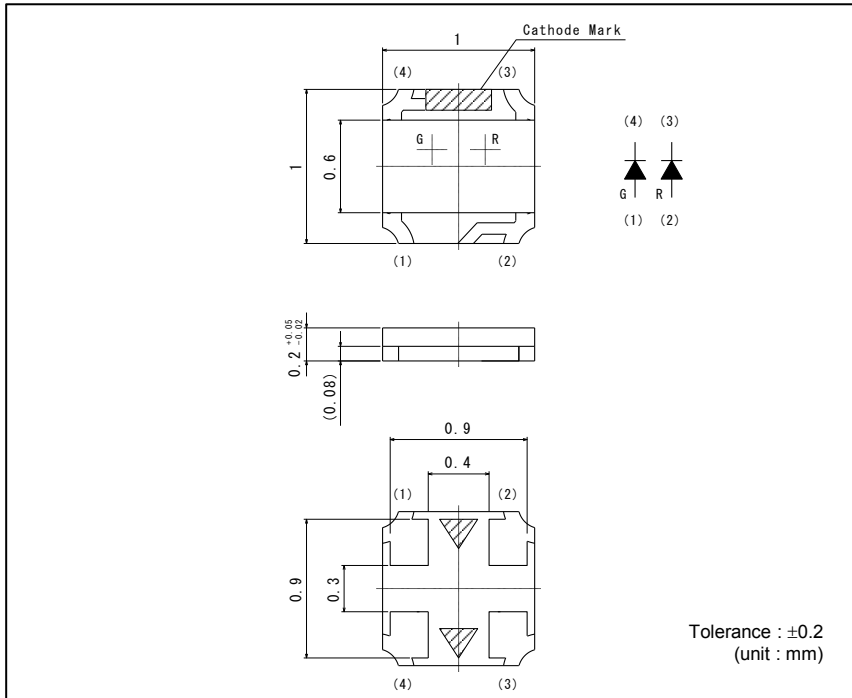

●Recommended Solder Pattern

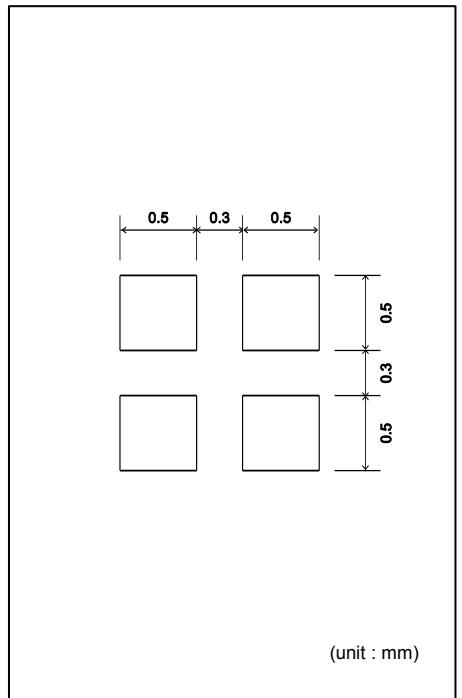

●Specifications

Part No.	Chip Structure	Emitting Color	Absolute Maximum Ratings (Ta=25°C)*3						Electrical and Optical Characteristics (Ta=25°C)										
			Power Dissipation P _D (mW)	Forward Current I _F (mA)	Peak Forward Current I _{FP} (mA)	Reverse Voltage V _R (V)	Operating Temp. Topr(°C)	Storage Temp. Tstg(°C)	Forward Voltage V _F		Reverse Current I _R		Dominant Wavelength λ _D			Luminous Intensity I _v			
			Typ.	I _F	Max.	V _R	Min.*2	Typ.	Max.*2	I _F	Min.	Typ.	I _F	Min.	Typ.	I _F			
SML-P24MUW (R)	AlGaInP on GaAs	Green Red	54 52	20	100*1	5	-40 to +85	-40 to +100	2.2 2.1	I _F 20	Max. 100	V _R 4	Min.*2 569	Typ. 572	Max.*2 575	I _F 20	Min. 10	Typ. 21	I _F 20

*1 : Duty1/10, 1kHz *2 : Reference
*3 : For the case of lighting a single color. When lighting two colors at the same time, the absolute maximum ratings of each color will be 50% of it.

*PICOLED™ is ROHM's pending trademark.

●Electrical Characteristics Curves

Fig.1 Forward Current - Forward Voltages

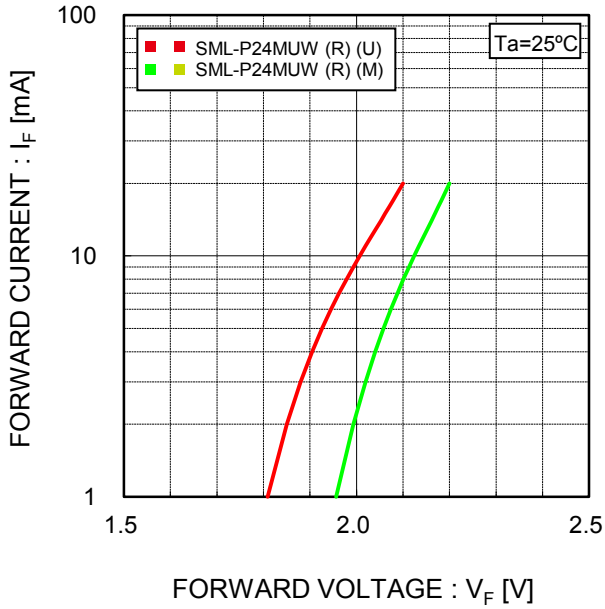

Fig.2 Luminous Intensity - Atmosphere Temperature

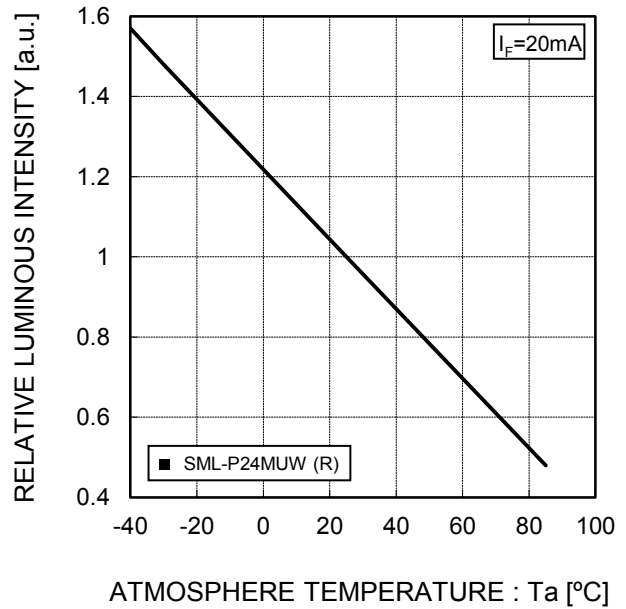

Fig.3 Luminous Intensity - Forward Current

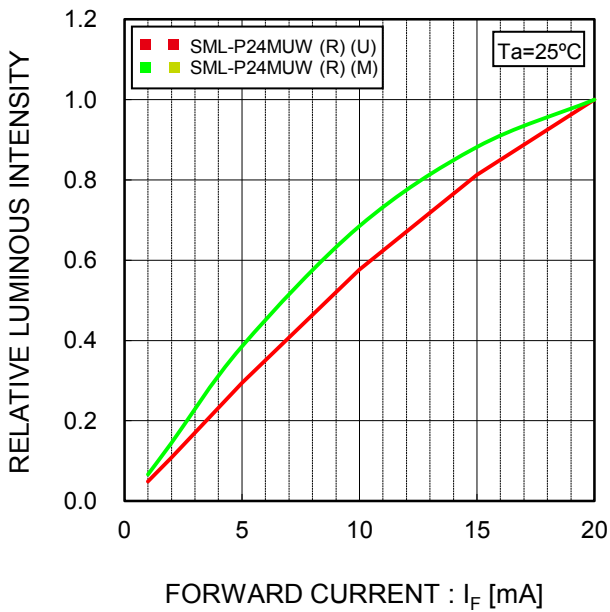
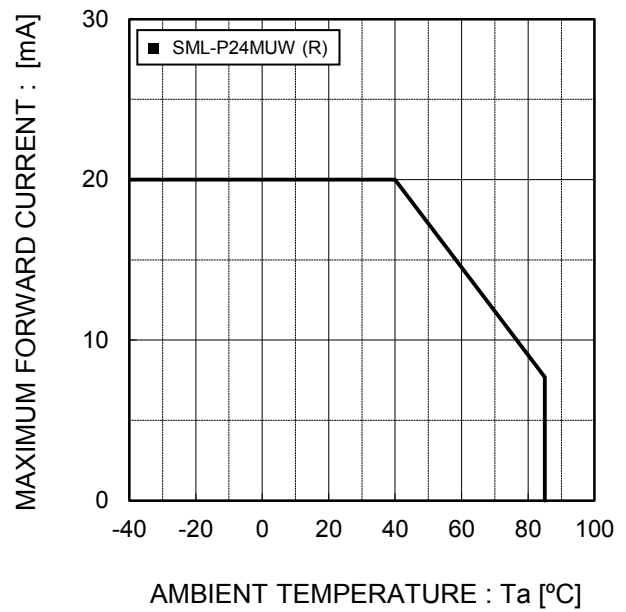
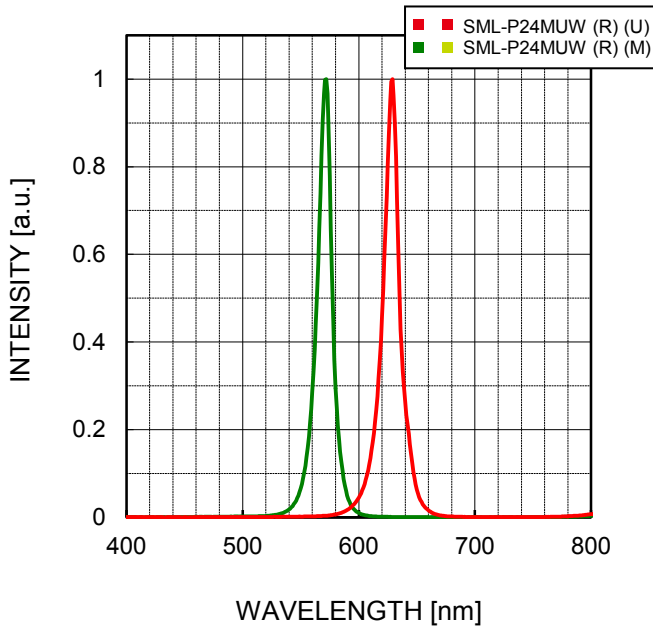

Fig.4 Derating



●Spectrum Data



* Please take this data as a reference data for the samples are measured randomly.
 * The data is relativized for each color. It is NOT to show the spectrum peaks are equal.

●Viewing Angle

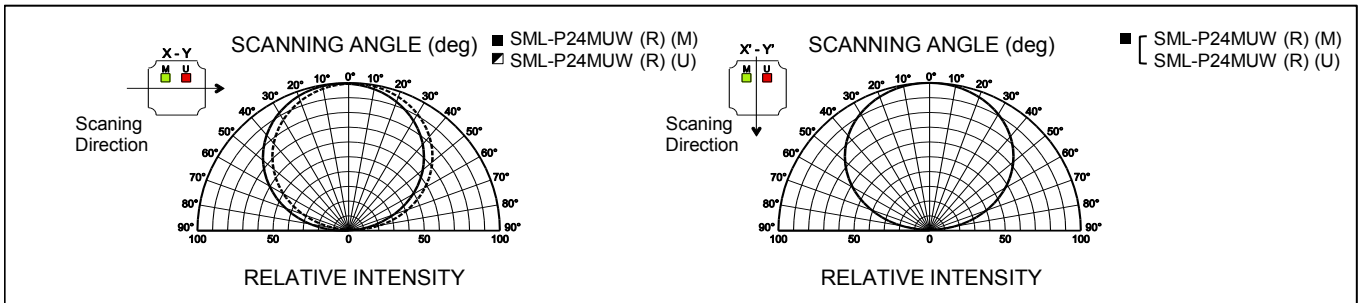

●Rank Reference of Brightness

SML-P24MUW (R)

(Ta=25°C, If=20mA)

Rank	K	L	M	N	P	Q	R	S	T	U
Iv (mcd)	4.0 to 6.3	6.3 to 10	10 to 16	16 to 25	25 to 40	40 to 63	63 to 100	90 to 140	140 to 220	220 to 360
SML-P24MUW (R)	Red									
	Yellowish Green									

●Taping

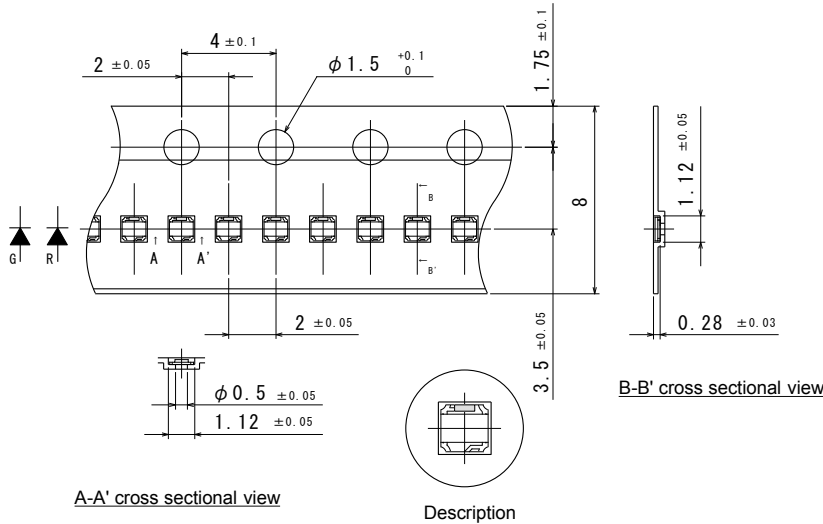

A-A' cross sectional view

B-B' cross sectional view

Description

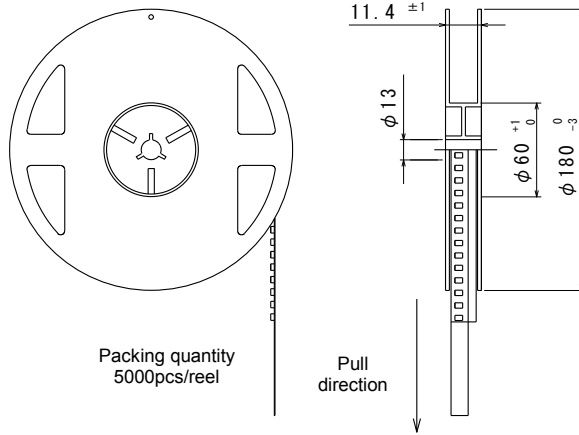

Packing quantity
5000pcs/reel

Pull
direction

(unit : mm)

(Note) Tolerance is ±0.1mm, unless otherwise specified.

●Part No. Construction

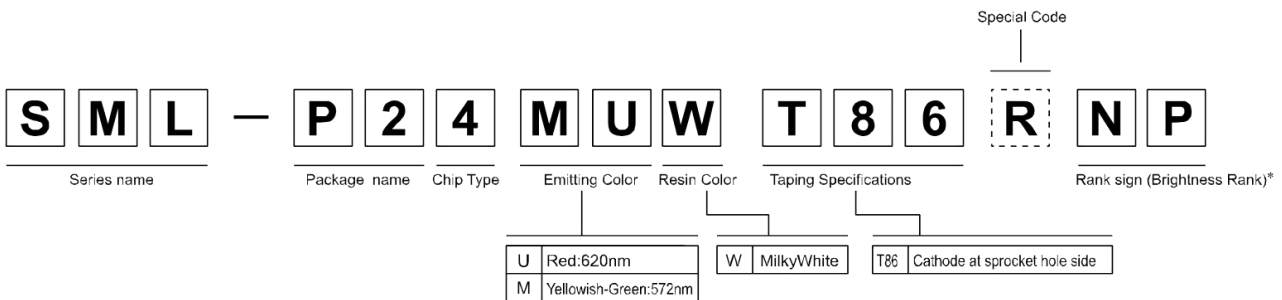

- Concerning the Brightness rank
- Please refer to the rank chart above for luminous intensity classification.
- Part name is individual for each rank.
- When shipped as sample, the part name will be a representative part name.
- General products are free of ranks. Please contact sales if rank appointment is needed.

●Packing Specification

ROHM LED products are being shipped with desiccant (silica gel) concluded in moisture-proof bags.

Pasting the moisture sensitive label on the outer surface of the moisture-proof bags or enclosing the humidity indication card inside the bag is available upon request.

Please contact the nearest sales office or distributor if necessary.

●Attention Points In Handling

This product was developed as a surface mount LED especially suitable for reflow soldering. Please take care of following points when using this device.

1.DESIGNING OF PCB

As for a recommendable solder pattern, Please refer to Fig-1.

The size and direction of the pad pattern depend on the condition of the PCB.

Thorough design review is recommended before the final designing.

Reference
Mask open area ratio : 80%
Mask thickness : 80 to 100μm

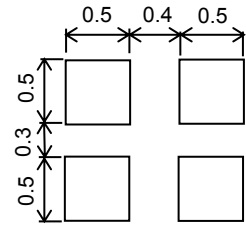

(Fig-1)

- (This product of structured with rear/bottom electrode to be soldered.)
- (The formation of solder fillet is not guaranteed due to its electrode shape.)

2.SOLDERING (Sn-Cu, Sn-Ag-Cu, Sn-Ag-Bi-Cu)

LED products do not contain reinforcement materials such as glass fillers.

Therefore, thermal stress by soldering greatly influences its reliability.

The temperature conditions for reflow soldering should therefore be set up according to the characteristic of this product. (See Fig-2)

Number of reflow process shall be max 2 times and these processes shall be performed in a row.

Cooling process to normal temperature shall be required between the first and the second soldering process

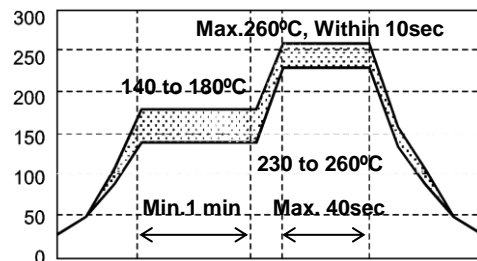

(Fig-2)

3.HANDLING AFTER MOUNTING (Fig.-3)

As shown in the drawing on the right, in case outside force of about 700g is given to the device, stress is concentrated to the jointed part between mold resin and substrate. Therefore there is a possibility to breath the device or PCB. Careful handling is needed as ROHM cannot guarantee the falling

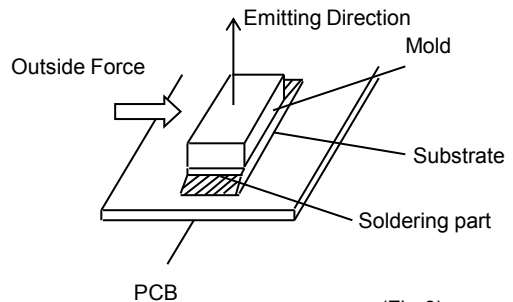

(Fig-3)

4.WASHING

Please note the following points when washing is required after soldering.

4-1) WASHING SOLVENT

Isopropyl alcohol or other alcohol solvent is recommendable.

4-2) TEMPERATURE

Below 30°C, immersion time ; within 3 minutes.

4-3) ULTRA SONIC WASHING

Below 15W/1 litter of solvent tub or less.

4-4) COOLING

Below 100°C within 3 minutes.

5.EROSION GAS

Utilization in erosion gas atmosphere may degenerate the plating surface which might cause deterioration of solder strength, optical characteristics, or functions.

Please take precautions against occurrence of gas from the surrounding parts on the occasion of custody, and also after mounted on circuit board.

6.STORAGE

At reflow soldering, the reliability of this product is often influenced by moisture absorption; so that we apply the package with moisture proof for better condition for use. Please also note that,

6-1) Package : Not to be opened before using.

6-2) After unpackaging : LEDs to be kept in our moisture proof package with some desiccant (SILICA GEL).

LEDs to be baked in case the SILICA GEL indicator changed its color from either blue to clear or green to pink.

6-3) Please use LEDs within 168 hours after the package is opened. (Condition at 30°C, max.70%Rh.)

In case they are not used within 168 hours, please put them back into the package.

6-4) BAKING (=Moisture Removal)

Please conduct baking under "reel condition" at 60°C, 12~24 hours (max.20%Rh) after unpackaging.

Please be careful not to give any stress to the reel & the embossed tape while baking, as they are susceptible to be deformed during the baking.

7.LIFE TIME

This product will cause reduction of luminous intensity depending on the using conditions and environmental.

Please inquire our sales contact if long life time is required on your application.

Notes

- 1) The information contained herein is subject to change without notice.
- 2) Before you use our Products, please contact our sales representative and verify the latest specifications :
- 3) Although ROHM is continuously working to improve product reliability and quality, semiconductors can break down and malfunction due to various factors.
Therefore, in order to prevent personal injury or fire arising from failure, please take safety measures such as complying with the derating characteristics, implementing redundant and fire prevention designs, and utilizing backups and fail-safe procedures. ROHM shall have no responsibility for any damages arising out of the use of our Products beyond the rating specified by ROHM.
- 4) Examples of application circuits, circuit constants and any other information contained herein are provided only to illustrate the standard usage and operations of the Products. The peripheral conditions must be taken into account when designing circuits for mass production.
- 5) The technical information specified herein is intended only to show the typical functions of and examples of application circuits for the Products. ROHM does not grant you, explicitly or implicitly, any license to use or exercise intellectual property or other rights held by ROHM or any other parties. ROHM shall have no responsibility whatsoever for any dispute arising out of the use of such technical information.
- 6) The Products are intended for use in general electronic equipment (i.e. AV/OA devices, communication, consumer systems, gaming/entertainment sets) as well as the applications indicated in this document.
- 7) The Products specified in this document are not designed to be radiation tolerant.
- 8) For use of our Products in applications requiring a high degree of reliability (as exemplified below), please contact and consult with a ROHM representative : transportation equipment (i.e. cars, ships, trains), primary communication equipment, traffic lights, fire/crime prevention, safety equipment, medical systems, servers, solar cells, and power transmission systems.
- 9) Do not use our Products in applications requiring extremely high reliability, such as aerospace equipment, nuclear power control systems, and submarine repeaters.
- 10) ROHM shall have no responsibility for any damages or injury arising from non-compliance with the recommended usage conditions and specifications contained herein.
- 11) ROHM has used reasonable care to ensure the accuracy of the information contained in this document. However, ROHM does not warrant that such information is error-free, and ROHM shall have no responsibility for any damages arising from any inaccuracy or misprint of such information.
- 12) Please use the Products in accordance with any applicable environmental laws and regulations, such as the RoHS Directive. For more details, including RoHS compatibility, please contact a ROHM sales office. ROHM shall have no responsibility for any damages or losses resulting from non-compliance with any applicable laws or regulations.
- 13) When providing our Products and technologies contained in this document to other countries, you must abide by the procedures and provisions stipulated in all applicable export laws and regulations, including without limitation the US Export Administration Regulations and the Foreign Exchange and Foreign Trade Act.
- 14) This document, in part or in whole, may not be reprinted or reproduced without prior consent of ROHM.



Thank you for your accessing to ROHM product informations.
More detail product informations and catalogs are available, please contact us.

ROHM Customer Support System

<http://www.rohm.com/contact/>

Mouser Electronics

Authorized Distributor

Click to View Pricing, Inventory, Delivery & Lifecycle Information:

[ROHM Semiconductor:](#)

[SML-P24MUWT86](#) [SML-P24MUWT86R](#)



Компания «ЭлектроПласт» предлагает заключение долгосрочных отношений при поставках импортных электронных компонентов на взаимовыгодных условиях!

Наши преимущества:

- Оперативные поставки широкого спектра электронных компонентов отечественного и импортного производства напрямую от производителей и с крупнейших мировых складов;
- Поставка более 17-ти миллионов наименований электронных компонентов;
- Поставка сложных, дефицитных, либо снятых с производства позиций;
- Оперативные сроки поставки под заказ (от 5 рабочих дней);
- Экспресс доставка в любую точку России;
- Техническая поддержка проекта, помощь в подборе аналогов, поставка прототипов;
- Система менеджмента качества сертифицирована по Международному стандарту ISO 9001;
- Лицензия ФСБ на осуществление работ с использованием сведений, составляющих государственную тайну;
- Поставка специализированных компонентов (Xilinx, Altera, Analog Devices, Intersil, Interpoint, Microsemi, Aeroflex, Peregrine, Syfer, Eurofarad, Texas Instrument, Miteq, Cobham, E2V, MA-COM, Hittite, Mini-Circuits, General Dynamics и др.);

Помимо этого, одним из направлений компании «ЭлектроПласт» является направление «Источники питания». Мы предлагаем Вам помощь Конструкторского отдела:

- Подбор оптимального решения, техническое обоснование при выборе компонента;
- Подбор аналогов;
- Консультации по применению компонента;
- Поставка образцов и прототипов;
- Техническая поддержка проекта;
- Защита от снятия компонента с производства.



Как с нами связаться

Телефон: 8 (812) 309 58 32 (многоканальный)

Факс: 8 (812) 320-02-42

Электронная почта: org@eplast1.ru

Адрес: 198099, г. Санкт-Петербург, ул. Калинина, дом 2, корпус 4, литера А.