

LCW Series Subminiature Sealed Snap-acting Switches

NEW



UL61058-1

Features/Benefits

- Compact design
- Quick connect, solder terminals, PC terminals, wire leads
- Wide variety of actuator styles
- RoHS compatible, RoHS compliant
- IP67
- New generation price competitive

Typical Applications

- Motorized equipment
- Sump pump
- Thermostatic controls
- Computers
- Air conditioners

Specifications

CONTACT RATING: from low level to 0.1 Amp
 ELECTRICAL LIFE: 10,000 cycles
 INSULATION RESISTANCE: 100 M ohm min.
 DIELECTRIC STRENGTH: 1,000 VAC
 OPERATING TEMPERATURE:
 -40°C to +120°C
 OPERATING FORCE: (see ACTUATOR'S option sections).
 MOUNTING: 2-56 screws, torque 2.3 in/lbs max.

Materials

SWITCH HOUSING: PBT
 SWITCH COVER: PBT
 ACTUATOR BUTTON: PBT
 SPRING: SUS
 MOVABLE CONTACTS: Copper
 STATIONARY CONTACTS: AgNi10
 TERMINALS: Brass.
 ACTUATOR LEVEL: SUS
 RUBBER: Silicone

NOTE: Specifications and materials listed above are for switches with standard options.
 For information on specific and custom switches, consult Customer Service center.

Snap-acting

Build-A-Switch

To order, simply select desired option from each category and place in the appropriate box. Available options are shown and described on pages J-44 thru J-47. For additional options not shown in catalog, consult Customer Service Center.

<div style="text-align: center;"> L C W </div>					
<p>Series LCW</p>					
<p>Electrical Rating</p> <table border="1" style="width: 100%;"> <tr> <td style="width: 15%;">Option Code</td> <td style="width: 45%; text-align: center;"> UL 61058-1 0.1 A 125/250 V AC </td> <td style="width: 40%; text-align: center;"> NA </td> </tr> </table>			Option Code	UL 61058-1 0.1 A 125/250 V AC	 NA
Option Code	UL 61058-1 0.1 A 125/250 V AC	 NA			
<p>Operating Force 2 203 grams</p>					
<p>Actuator</p> <ul style="list-style-type: none"> P00 Pin plunger T00 12 mm short lever T05 17.5 mm short lever T07 19.5 mm short lever T13 25.6 mm lever S26 18.6 mm simulated lever 					
<p>Terminations</p> <ul style="list-style-type: none"> S Solder Q 0.110 Quick Connect P PC Thru Hole W Wire leads potted 					
<p>Circuitry</p> <ul style="list-style-type: none"> C SPDT W SPST N.C. Y SPST N.O. 					
<p>Wire Side</p> <ul style="list-style-type: none"> A Wire out the bottom (check if available) B Wire out the right side (check if available) D None (Default) 					



NEW

LCW Series Subminiature Sealed Snap-acting Switches

SERIES 

LCW

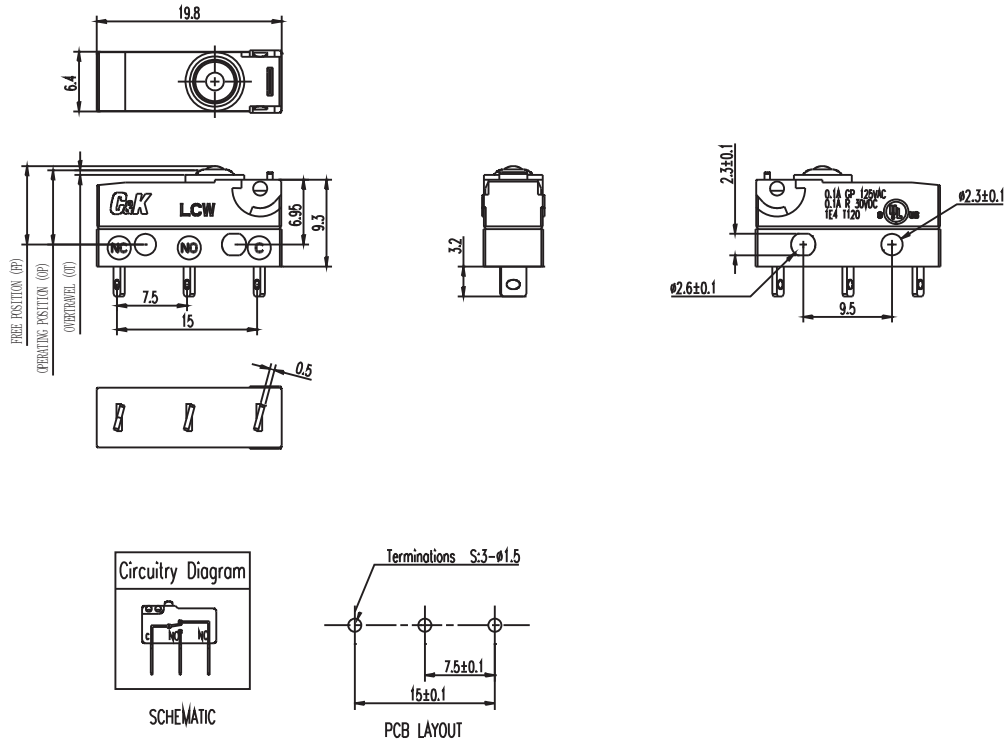

Snap-acting

ELECTRICAL RATING

RoHS COMPLIANT *	RoHS COMPATIBLE *	OPTION CODE	ELECTRICAL RATING
YES	YES	01	0.1 AMP, 125/250 V AC

OPERATING FORCE

OPTION CODE	OPERATING FORCES (grams)
2	203 g. max.

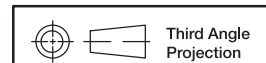

Dimensions are shown: mm
Specifications and dimensions subject to change



LCW Series Subminiature Sealed Snap-acting Switches

NEW

ACTUATOR 

P00

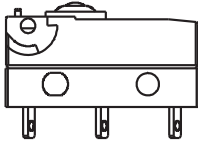

T07

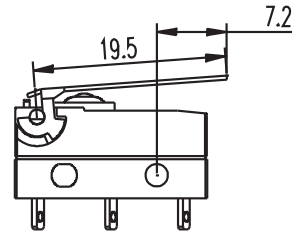

T00

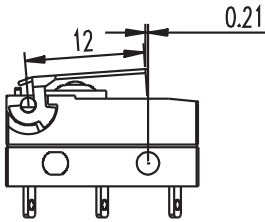

T13

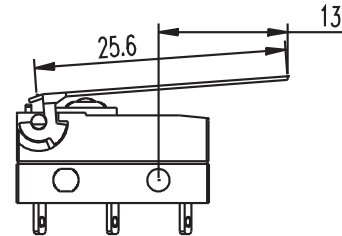

T05

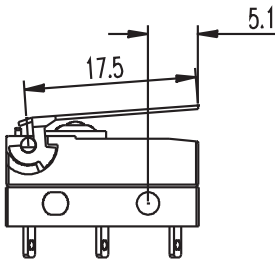

S26

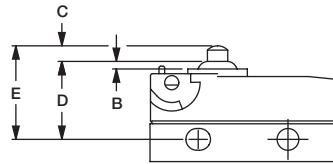
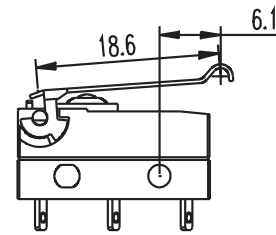

Snap-acting

Actuator Option Code	A	B	C	D	E	Differential Motion (max)	Operating Force (Max)	Release Force (Min)
	Length of Lever	Overtravel (min)	Pretravel (max)	Operating Position	Free Position (max)			
P00	Not Applicable	0.6	1	8.7±0.3	9.4	0.9	203	30
T00	12	0.6	4.9	8.8±1.2	12.5	1	100	15
T05	17.5	0.6	5.7	8.8±1.5	13	1.2	90	10
T07	19.5	0.6	6.2	8.8±1.5	13.5	1.2	70	10
T13	25.6	1	4.7	8.8-11.24	13.5	1.5	54	5
S26	18.6	0.6	4.6	10.7±1.2	14.1	1.5	68	5

Dimensions are in mm and force in grams



Third Angle Projection

Dimensions are shown: mm
Specifications and dimensions subject to change



26 Feb 19

NEW

LCW Series Subminiature Sealed Snap-acting Switches

TERMINATIONS

S SOLDER

Q QUICK CONNECT 2.8mm / 0.110"

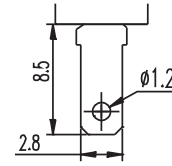
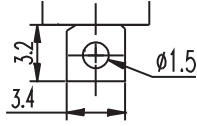

P PC THRU HOLE

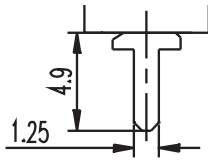

W "A" WIRE ORIENTATION OUT THE BOTTOM
"W" CIRCUITRY

W "B" WIRE ORIENTATION OUT THE RIGHT SIDE
"W" CIRCUITRY

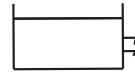

Snap-acting

CIRCUITRY

C SPDT (Single Pole, Double Throw)

W SPST N.C. (Single Pole, Single Throw, Normally Closed)

Y SPST N.O. (Single Pole, Single Throw, Normally Open)



Third Angle
Projection

Dimensions are shown: mm
Specifications and dimensions subject to change



26 Feb 19



Компания «ЭлектроПласт» предлагает заключение долгосрочных отношений при поставках импортных электронных компонентов на взаимовыгодных условиях!

Наши преимущества:

- Оперативные поставки широкого спектра электронных компонентов отечественного и импортного производства напрямую от производителей и с крупнейших мировых складов;
- Поставка более 17-ти миллионов наименований электронных компонентов;
- Поставка сложных, дефицитных, либо снятых с производства позиций;
- Оперативные сроки поставки под заказ (от 5 рабочих дней);
- Экспресс доставка в любую точку России;
- Техническая поддержка проекта, помощь в подборе аналогов, поставка прототипов;
- Система менеджмента качества сертифицирована по Международному стандарту ISO 9001;
- Лицензия ФСБ на осуществление работ с использованием сведений, составляющих государственную тайну;
- Поставка специализированных компонентов (Xilinx, Altera, Analog Devices, Intersil, Interpoint, Microsemi, Aeroflex, Peregrine, Syfer, Eurofarad, Texas Instrument, Miteq, Cobham, E2V, MA-COM, Hittite, Mini-Circuits, General Dynamics и др.);

Помимо этого, одним из направлений компании «ЭлектроПласт» является направление «Источники питания». Мы предлагаем Вам помощь Конструкторского отдела:

- Подбор оптимального решения, техническое обоснование при выборе компонента;
- Подбор аналогов;
- Консультации по применению компонента;
- Поставка образцов и прототипов;
- Техническая поддержка проекта;
- Защита от снятия компонента с производства.



Как с нами связаться

Телефон: 8 (812) 309 58 32 (многоканальный)

Факс: 8 (812) 320-02-42

Электронная почта: org@eplast1.ru

Адрес: 198099, г. Санкт-Петербург, ул. Калинина, дом 2, корпус 4, литера А.