





Standard type:  (AQV258) / Reinforced type:  (AQV253H, AQV254H)   (AQV256H)

**DIP6-pin type with  
low on-resistance and  
reinforced insulation**

**PhotoMOS<sup>®</sup>  
HE 1 Form A  
(AQV250, AQV250H)**

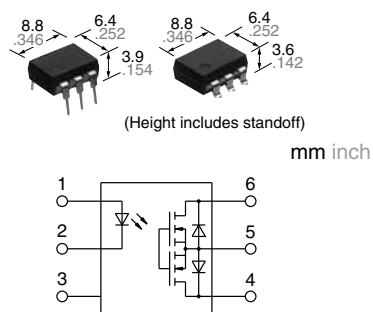

**RoHS compliant**

### FEATURES

1. Wide variation of 40V, 60V, 100V, 200V, 250V, 400V, 600V, 1,000V and 1,500V load voltage
2. Low on-resistance of Typ. 0.6Ω (AQV251)
3. Reinforced insulation type of 5,000Vrms I/O isolation available

### TYPICAL APPLICATIONS

- Measuring instruments
- Data communication equipment
- Telephone equipment
- Automatic meter reading device

### TYPES

	I/O isolation	Output rating*		Package	Part No.				Packing quantity	
					Through hole terminal	Surface-mount terminal		Tube	Tape and reel	
						Tube packing style				Tape and reel packing style
		Load voltage	Load current			Picked from the 1/2/3-pin side	Picked from the 4/5/6-pin side			
AC/DC dual use	1,500Vrms	40 V	500 mA	DIP6-pin	AQV251	AQV251A	AQV251AX	AQV251AZ	1 tube contains: 50 pcs. 1 batch contains: 500 pcs.	1,000 pcs.
		60 V	400 mA		AQV252	AQV252A	AQV252AX	AQV252AZ		
		100 V	350 mA		AQV255	AQV255A	AQV255AX	AQV255AZ		
		200 V	250 mA		AQV257	AQV257A	AQV257AX	AQV257AZ		
		250 V	200 mA		AQV253	AQV253A	AQV253AX	AQV253AZ		
		400 V	150 mA		AQV254	AQV254A	AQV254AX	AQV254AZ		
		1,000 V	30 mA		AQV259	AQV259A	AQV259AX	AQV259AZ		
		1,500 V	20 mA		AQV258	AQV258A	AQV258AX	AQV258AZ		
	Reinforced 5,000Vrms	250 V	200 mA		AQV253H	AQV253HA	AQV253HAX	AQV253HAZ		
		400 V	150 mA		AQV254H	AQV254HA	AQV254HAX	AQV254HAZ		
		600 V	130 mA		AQV256H	AQV256HA	AQV256HAX	AQV256HAZ		

\*Indicate the peak AC and DC values.

Note: The surface mount terminal indicator "A" and the packing style indicator "X" or "Z" are not marked on the device.

## RATING

### 1. Absolute maximum ratings (Ambient temperature: 25°C 77°F)

Item	Sym- bol	Type of connec- tion	AQV251(A)	AQV252(A)	AQV255(A)	AQV257(A)	AQV253(A)	AQV254(A)	AQV259(A)	AQV258(A)	AQV253H(A)	AQV254H(A)	AQV256H(A)	Remarks
LED forward current	I <sub>F</sub>		50 mA											
LED reverse voltage	V <sub>R</sub>		5 V											
Peak forward current	I <sub>FP</sub>		1 A											f = 100 Hz, Duty factor +0.1%
Power dissipation	P <sub>in</sub>		75 mW											
Load voltage (peak AC)	V <sub>L</sub>		40V	60V	100V	200V	250V	400V	1,000V	1,500V	250V	400V	600V	
Continuous load current	I <sub>L</sub>	A	0.5A	0.4A	0.35A	0.25A	0.2A	0.15A	0.03A	0.02A	0.2A	0.15A	0.13A	A connection: Peak AC, DC B, C connection: DC
		B	0.7A	0.6A	0.45A	0.35A	0.3A	0.18A	0.04A	0.025A	0.3A	0.18A	0.14A	
		C	1.0A	0.8A	0.70A	0.5A	0.4A	0.25A	0.05A	0.04A	0.4A	0.25A	0.16A	
Peak load current	I <sub>peak</sub>		1.8A	1.5A	1.0A	0.75A	0.6A	0.5A	0.09A	0.06A	0.6A	0.5A	0.4A	A connection: 100 ms (1 shot) V <sub>L</sub> = DC
Power dissipation	P <sub>out</sub>		360 mW											
Total power dissipation	P <sub>T</sub>		410 mW											
I/O isolation voltage	V <sub>iso</sub>		1,500 Vrms						5,000 Vrms					
Ambient temperature	Operating	T <sub>opr</sub>	-40 to +85°C -40 to +185°F											(Non-icing at low temperatures)
	Storage	T <sub>stg</sub>	-40 to +100°C -40 to +212°F											

### 2. Electrical characteristics (Ambient temperature: 25°C 77°F)

Item	Sym- bol	Type of connec- tion	AQV251(A)	AQV252(A)	AQV255(A)	AQV257(A)	AQV253(A)	AQV254(A)	AQV259(A)	AQV258(A)	AQV253H(A)	AQV254H(A)	AQV256H(A)	Condition		
Input	LED operate current	Typical	0.9 mA						1.4 mA					I <sub>L</sub> = Max.		
		Maximum	3 mA													
	LED turn off current	Minimum	0.4 mA											I <sub>L</sub> = Max.		
		Typical	0.8 mA						1.3 mA							
LED dropout voltage	Typical	V <sub>F</sub>	1.25 V (1.14 V at I <sub>F</sub> = 5 mA)											I <sub>F</sub> = 50 mA		
	Maximum		1.5 V													
Output	On resistance	Typical	R <sub>on</sub>	A	0.6 Ω	0.74 Ω	1.8 Ω	2.6 Ω	5.5 Ω	12.4 Ω	85 Ω	345 Ω	5.5 Ω	12.4 Ω	20 Ω	I <sub>F</sub> = 5 mA I <sub>L</sub> = Max. Within 1 s
				Maximum	1 Ω	1.4 Ω	2.5 Ω	4 Ω	8 Ω	16 Ω	200 Ω	500 Ω	8 Ω	16 Ω	30 Ω	
		Typical	R <sub>on</sub>	B	0.3Ω	0.37 Ω	0.9 Ω	1.4 Ω	2.7 Ω	6.2 Ω	60 Ω	345 Ω	2.7 Ω	6.2 Ω	15 Ω	
				Maximum	0.5 Ω	0.7 Ω	1.25 Ω	2 Ω	4 Ω	8 Ω	100 Ω	500 Ω	4 Ω	8 Ω	20 Ω	
	Typical	R <sub>on</sub>	C	0.15 Ω	0.18 Ω	0.45 Ω	0.7 Ω	1.4 Ω	3.1 Ω	30 Ω	160 Ω	1.4 Ω	3.1 Ω	7.5 Ω	I <sub>F</sub> = 5 mA I <sub>L</sub> = Max. Within 1 s	
			Maximum	0.25 Ω	0.35 Ω	0.63 Ω	1 Ω	2 Ω	4 Ω	50 Ω	250 Ω	2 Ω	4 Ω	10 Ω		
Off state leakage current	Maximum	I <sub>Leak</sub>	1 μA						10 μA			1 μA		I <sub>F</sub> = 0 mA V <sub>L</sub> = Max.		
Transfer characteristics	Turn on time*	Typical	T <sub>on</sub>	1.7 ms	1.4 ms	0.9 ms	1.5 ms	0.8 ms	0.6 ms	0.35 ms	2.4 ms	1.8 ms	1.2 ms	I <sub>F</sub> = 5 mA I <sub>L</sub> = Max.		
		Maximum	3 ms	2 ms	3 ms	2 ms	1 ms	4 ms	3ms							
	Turn off time*	Typical	T <sub>off</sub>	0.07 ms	0.09 ms	0.1 ms	0.06 ms	0.05 ms	0.04 ms	0.06 ms	0.05 ms	0.06 ms	I <sub>F</sub> = 5 mA I <sub>L</sub> = Max.			
		Maximum	0.2 ms													
	I/O capacitance	Typical	C <sub>iso</sub>	1.3 pF											f = 1 MHz V <sub>B</sub> = 0 V	
Maximum		3 pF														
Initial I/O isolation resistance	Minimum	R <sub>iso</sub>	1,000 MΩ											500 V DC		

\*Turn on/Turn off time

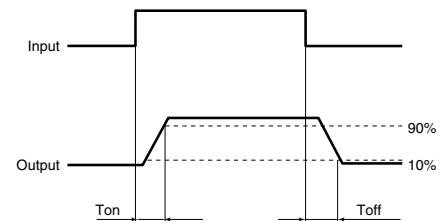

**3. Recommended operating conditions** (Ambient temperature: 25°C 77°F)

Please use under recommended operating conditions to obtain expected characteristics.

	Item	Symbol	Min.	Max.	Unit
	LED current	I <sub>F</sub>	5	30	mA
AQV251(A)	Load voltage (Peak AC)	V <sub>L</sub>	—	32	V
	Continuous load current (A connection)	I <sub>L</sub>	—	0.5	A
AQV252(A)	Load voltage (Peak AC)	V <sub>L</sub>	—	48	V
	Continuous load current (A connection)	I <sub>L</sub>	—	0.4	A
AQV255(A)	Load voltage (Peak AC)	V <sub>L</sub>	—	80	V
	Continuous load current (A connection)	I <sub>L</sub>	—	0.35	A
AQV257(A)	Load voltage (Peak AC)	V <sub>L</sub>	—	160	V
	Continuous load current (A connection)	I <sub>L</sub>	—	0.25	A
AQV253(A)	Load voltage (Peak AC)	V <sub>L</sub>	—	200	V
	Continuous load current (A connection)	I <sub>L</sub>	—	0.2	A
AQV254(A)	Load voltage (Peak AC)	V <sub>L</sub>	—	320	V
	Continuous load current (A connection)	I <sub>L</sub>	—	0.15	A
AQV259(A)	Load voltage (Peak AC)	V <sub>L</sub>	—	800	V
	Continuous load current (A connection)	I <sub>L</sub>	—	0.03	A
AQV258(A)	Load voltage (Peak AC)	V <sub>L</sub>	—	1200	V
	Continuous load current (A connection)	I <sub>L</sub>	—	0.02	A
AQV253H(A)	Load voltage (Peak AC)	V <sub>L</sub>	—	200	V
	Continuous load current (A connection)	I <sub>L</sub>	—	0.2	A
AQV254H(A)	Load voltage (Peak AC)	V <sub>L</sub>	—	320	V
	Continuous load current (A connection)	I <sub>L</sub>	—	0.15	A
AQV256H(A)	Load voltage (Peak AC)	V <sub>L</sub>	—	480	V
	Continuous load current (A connection)	I <sub>L</sub>	—	0.13	A

■ **These products are not designed for automotive use.**

If you are considering to use these products for automotive applications, please contact your local Panasonic Corporation technical representative.

■ **Continual DC bias (for AQV258\*\*, AQV259\*\*)**

In cases in which a continual DC bias is applied between the input and output, the output-side MOS-FET may deteriorate due to the voltage. Therefore, please verify operation of the actual design before using. An example of a circuit that might undergo MOS-FET deterioration due to voltage is given below.

**REFERENCE DATA**

1.-(1) Load current vs. ambient temperature characteristics

Allowable ambient temperature: -40 to +85°C  
-40 to +185°F ;

Type of connection: A

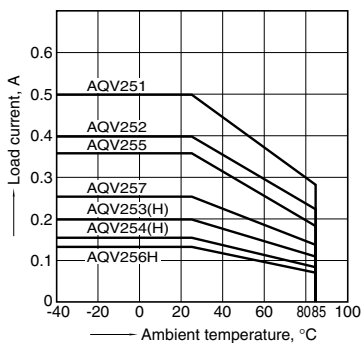

1.-(2) Load current vs. ambient temperature characteristics

Allowable ambient temperature: -40 to +85°C  
-40 to +185°F ;

Type of connection: A

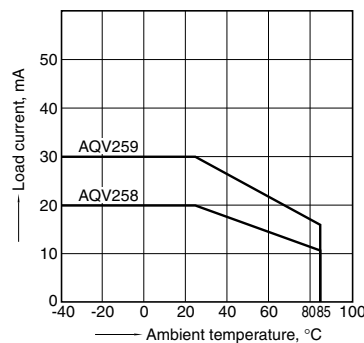

2.-(1) On resistance vs. ambient temperature characteristics

Measured portion: between terminals 4 and 6;  
LED current: 5 mA;  
Continuous load current: Max. (DC)

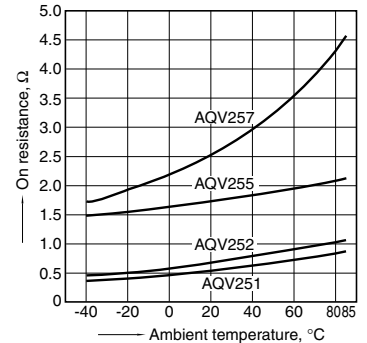

2.-(2) On resistance vs. ambient temperature characteristics

Measured portion: between terminals 4 and 6;  
LED current: 5 mA;  
Continuous load current: Max. (DC)

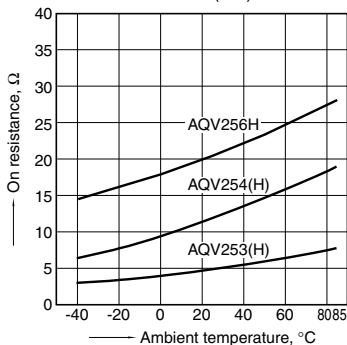

2.-(3) On resistance vs. ambient temperature characteristics

Measured portion: between terminals 4 and 6;  
LED current: 5 mA;  
Continuous load current: 30 mA (DC)

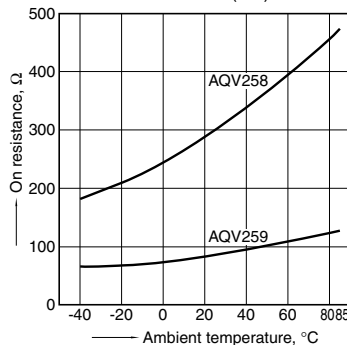

3.-(1) Turn on time vs. ambient temperature characteristics

LED current: 5 mA;  
Load voltage: Max. (DC);  
Continuous load current: Max. (DC)

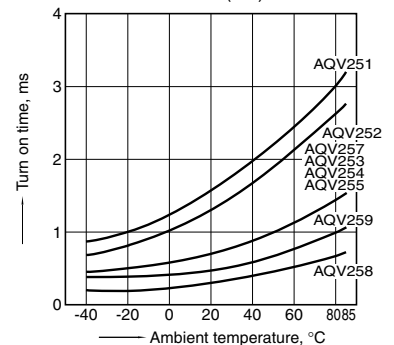

# HE 1 Form A (AQV250, AQV250H)

## 3.-(2) Turn on time vs. ambient temperature characteristics

LED current: 5 mA; Load voltage: Max. (DC);  
Continuous load current: Max. (DC)

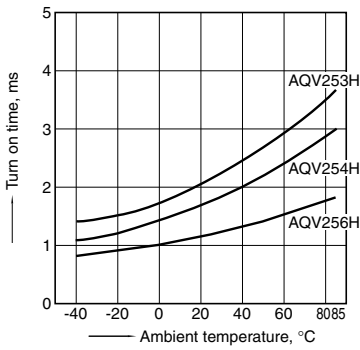

## 4.-(1) Turn off time vs. ambient temperature characteristics

LED current: 5 mA; Load voltage: Max. (DC);  
Continuous load current: Max. (DC)

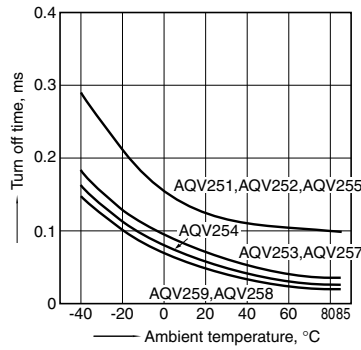

## 4.-(2) Turn off time vs. ambient temperature characteristics

Sample: AQV253H, AQV254H, AQV256H  
LED current: 5 mA; Load voltage: Max. (DC);  
Continuous load current: Max. (DC)

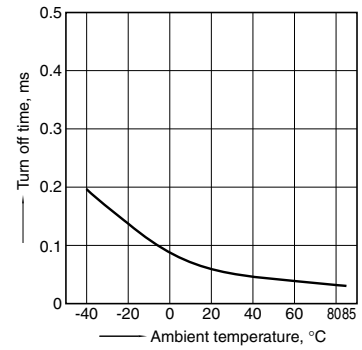

## 5.-(1) LED operate current vs. ambient temperature characteristics

Sample: AQV251, AQV252, AQV253, AQV254, AQV255, AQV257, AQV258, AQV259; Load voltage: Max. (DC); Continuous load current: Max. (DC)

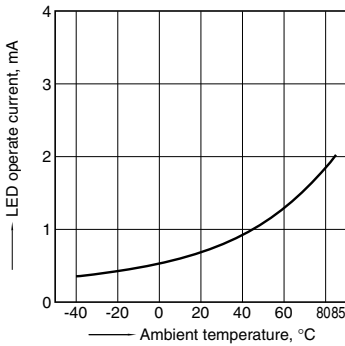

## 5.-(2) LED operate current vs. ambient temperature characteristics

Sample: AQV253H, AQV254H, AQV256H; Load voltage: Max. (DC); Continuous load current: Max. (DC)

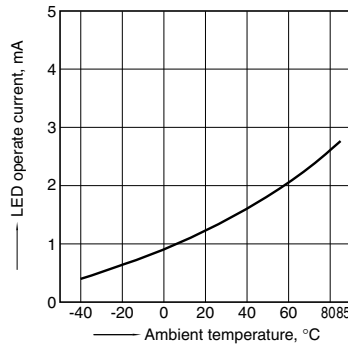

## 6.-(1) LED turn off current vs. ambient temperature characteristics

Sample: AQV251, AQV252, AQV253, AQV254, AQV255, AQV257, AQV258, AQV259; Load voltage: Max. (DC); Continuous load current: Max. (DC)

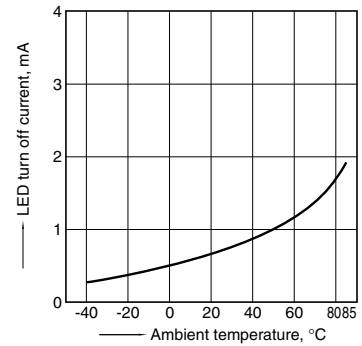

## 6.-(2) LED turn off current vs. ambient temperature characteristics

Sample: AQV253H, AQV254H, AQV256H; Load voltage: Max. (DC); Continuous load current: Max. (DC)

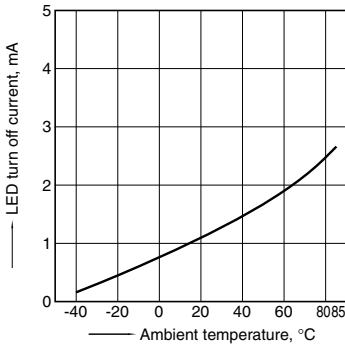

## 7. LED dropout voltage vs. ambient temperature characteristics

LED current: 5 to 50 mA

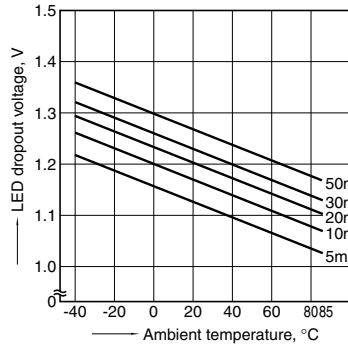

## 8.-(1) Current vs. voltage characteristics of output at MOS portion

Measured portion: between terminals 4 and 6;  
Ambient temperature: 25°C 77°F

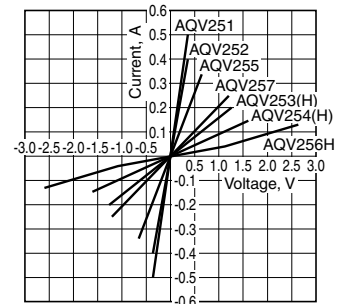

## 8.-(2) Current vs. voltage characteristics of output at MOS portion

Measured portion: between terminals 4 and 6;  
Ambient temperature: 25°C 77°F

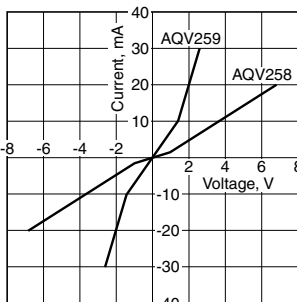

## 9.-(1) Off state leakage current vs. load voltage characteristics

Sample: AQV259; Measured portion: between terminals 4 and 6;  
Ambient temperature: 25°C 77°F

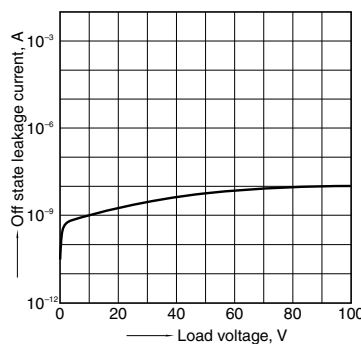

## 9.-(2) Off state leakage current vs. load voltage characteristics

Measured portion: between terminals 4 and 6;  
Ambient temperature: 25°C 77°F

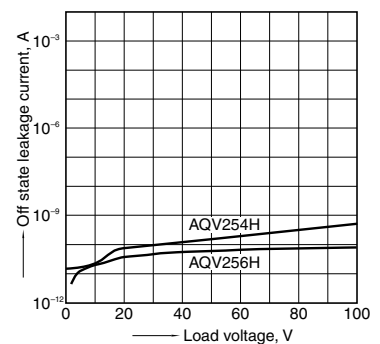

10-(1). Turn on time vs. LED forward current characteristics

Measured portion: between terminals 4 and 6;  
Load voltage: Max. (DC); Continuous load current: Max. (DC); Ambient temperature: 25°C 77°F

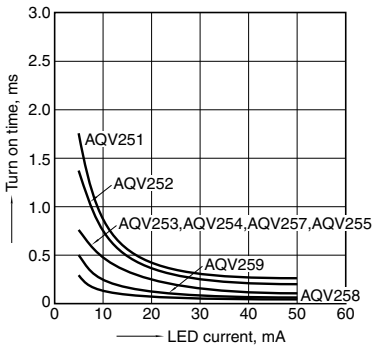

10-(2). Turn on time vs. LED forward current characteristics

Measured portion: between terminals 4 and 6;  
Load voltage: Max. (DC); Continuous load current: Max. (DC); Ambient temperature: 25°C 77°F

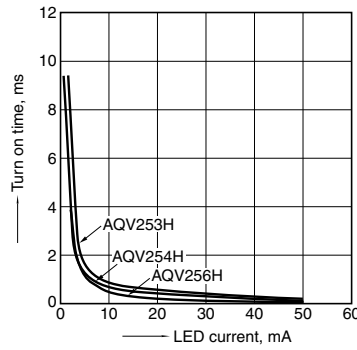

11-(1). Turn off time vs. LED forward current characteristics

Measured portion: between terminals 4 and 6;  
Load voltage: Max. (DC); Continuous load current: Max. (DC); Ambient temperature: 25°C 77°F

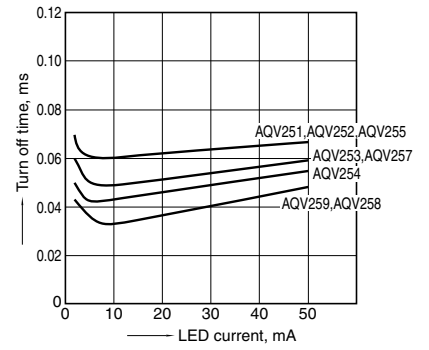

11-(2). Turn off time vs. LED forward current characteristics

Measured portion: between terminals 4 and 6;  
Load voltage: Max. (DC); Continuous load current: Max. (DC); Ambient temperature: 25°C 77°F

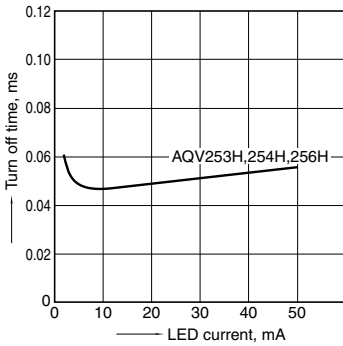

12-(1) Output capacitance vs. applied voltage characteristics

Measured portion: between terminals 4 and 6;  
Frequency: 1 MHz;  
Ambient temperature: 25°C 77°F

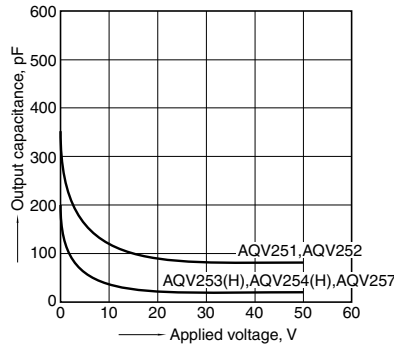

12-(2) Output capacitance vs. applied voltage characteristics

Sample: AQV259;  
Measured portion: between terminals 4 and 6;  
Frequency: 1 MHz; Ambient temperature: 25°C 77°F

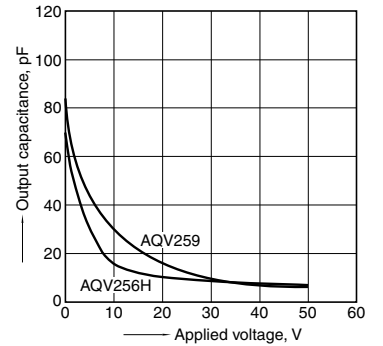

"PhotoMOS®", "PhotoMOS" and "PHOTOMOS" are registered trademarks of Panasonic Corporation.

\*Recognized in Japan, the United States, all member states of European Union and other countries.

Please contact .....

**Panasonic Corporation**

Electromechanical Control Business Division

■ 1006, Oaza Kadoma, Kadoma-shi, Osaka 571-8506, Japan  
[industrial.panasonic.com/ac/e/](http://industrial.panasonic.com/ac/e/)

**Panasonic®**

©Panasonic Corporation 2017

# Mouser Electronics

Authorized Distributor

Click to View Pricing, Inventory, Delivery & Lifecycle Information:

[Panasonic:](#)

[AQV214EA](#) [AQV214EH](#) [AQV212EHAZ](#)



Компания «ЭлектроПласт» предлагает заключение долгосрочных отношений при поставках импортных электронных компонентов на взаимовыгодных условиях!

Наши преимущества:

- Оперативные поставки широкого спектра электронных компонентов отечественного и импортного производства напрямую от производителей и с крупнейших мировых складов;
- Поставка более 17-ти миллионов наименований электронных компонентов;
- Поставка сложных, дефицитных, либо снятых с производства позиций;
- Оперативные сроки поставки под заказ (от 5 рабочих дней);
- Экспресс доставка в любую точку России;
- Техническая поддержка проекта, помощь в подборе аналогов, поставка прототипов;
- Система менеджмента качества сертифицирована по Международному стандарту ISO 9001;
- Лицензия ФСБ на осуществление работ с использованием сведений, составляющих государственную тайну;
- Поставка специализированных компонентов (Xilinx, Altera, Analog Devices, Intersil, Interpoint, Microsemi, Aeroflex, Peregrine, Syfer, Eurofarad, Texas Instrument, Miteq, Cobham, E2V, MA-COM, Hittite, Mini-Circuits, General Dynamics и др.);

Помимо этого, одним из направлений компании «ЭлектроПласт» является направление «Источники питания». Мы предлагаем Вам помощь Конструкторского отдела:

- Подбор оптимального решения, техническое обоснование при выборе компонента;
- Подбор аналогов;
- Консультации по применению компонента;
- Поставка образцов и прототипов;
- Техническая поддержка проекта;
- Защита от снятия компонента с производства.



#### Как с нами связаться

**Телефон:** 8 (812) 309 58 32 (многоканальный)

**Факс:** 8 (812) 320-02-42

**Электронная почта:** [org@eplast1.ru](mailto:org@eplast1.ru)

**Адрес:** 198099, г. Санкт-Петербург, ул. Калинина, дом 2, корпус 4, литера А.