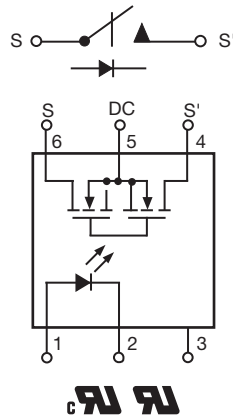


## 1 Form A Solid State Relay



20091



### FEATURES

- High speed SSR -  $t_{on}/t_{off} < 800 \mu s$
- Maximum  $R_{ON} 0.25 \Omega$
- Isolation test voltage 5300  $V_{RMS}$
- Load voltage 60 V
- Load current 2 A DC configuration
- DIP-6 package
- Clean bounce free switching
- TTL/CMOS compatible input
- Available on tape and reel
- Pure tin leads
- Compliant to RoHS Directive 2002/95/EC and in accordance to WEEE 2002/96/EC



**RoHS**  
COMPLIANT

### DESCRIPTION

The VO14642AT are high speed SPST normally open (1 form A) solid-state relay in a DIP-6 package. The relays are constructed as a multi-chip hybrid device. Actuation control is via an infrared LED. The output switch is a combination of a photodiode array with MOSFET switches. The relays can be configured for AC/DC or DC only operation.

### APPLICATIONS

- Instrumentation
- Industrial controls
- Security

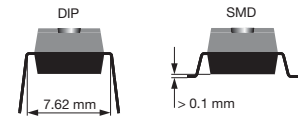
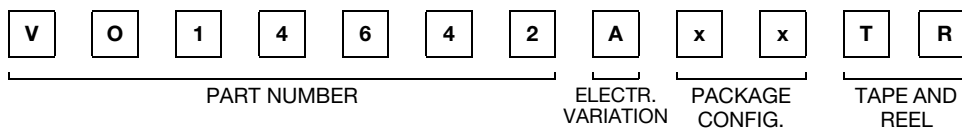
### AGENCY APPROVALS

UL1577: file no. E52744 system code H, double protection  
 cUL - UL1577: file no. E52744 system code H, double protection

### Notes

- IEC 60747-5-2 (VDE 0884) capable, consult sales representative for details
- Agency approvals are valid only for ambient temperature range - 40 °C to 85 °C

### ORDERING INFORMATION



| PACKAGE              | UL, cUL      |
|----------------------|--------------|
| SMD-6, tape and reel | VO14642AABTR |
| DIP-6, Tubes         | VO14642AT    |

| <b>ABSOLUTE MAXIMUM RATINGS (1)</b> ( $T_{amb} = 25\text{ }^{\circ}\text{C}$ , unless otherwise specified) |                           |            |               |           |
|--|---------------------------|------------|---------------|-----------|
| PARAMETER  | TEST CONDITION            | SYMBOL     | VALUE         | UNIT      |
| <b>INPUT</b>   |                           |            |               |           |
| LED continuous forward current   |                           | $I_F$      | 50            | mA        |
| LED reverse voltage  |                           | $V_R$      | 5             | V         |
| LED power dissipation  | at 25 °C                  | $P_{diss}$ | 80            | mW        |
| <b>OUTPUT</b>  |                           |            |               |           |
| DC or peak AC load voltage   |                           | $V_L$      | 60            | V         |
| Load current (DC only)   |                           | $I_L$      | 2             | A         |
| Peak load current (AC/DC)  | $t = 10\text{ ms}$        | $I_{LPK}$  | 3.6           | A         |
| Output power dissipation   | at 25 °C                  | $P_{diss}$ | 250           | mW        |
| <b>SSR</b>   |                           |            |               |           |
| Total power dissipation  |                           | $P_{diss}$ | 330           | mW        |
| Ambient temperature range  |                           | $T_{amb}$  | - 55 to + 85  | °C        |
| Storage temperature range  |                           | $T_{stg}$  | - 55 to + 125 | °C        |
| Soldering temperature (2)  | $t \leq 10\text{ s max.}$ | $T_{sld}$  | 260           | °C        |
| Isolation test voltage   | for 1 s                   | $V_{ISO}$  | 5300          | $V_{RMS}$ |

**Notes**

(1) Stresses in excess of the absolute maximum ratings can cause permanent damage to the device. Functional operation of the device is not implied at these or any other conditions in excess of those given in the operational sections of this document. Exposure to absolute maximum ratings for extended periods of the time can adversely affect reliability.

(2) Refer to reflow profile for soldering conditions for surface mounted devices (SMD). Refer to wave profile for soldering conditions for through hole devices (DIP).

**ABSOLUTE MAXIMUM RATING CURVE**

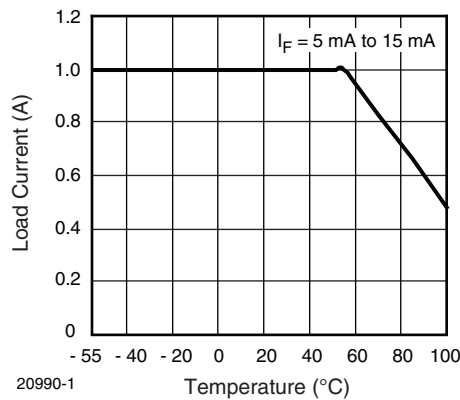
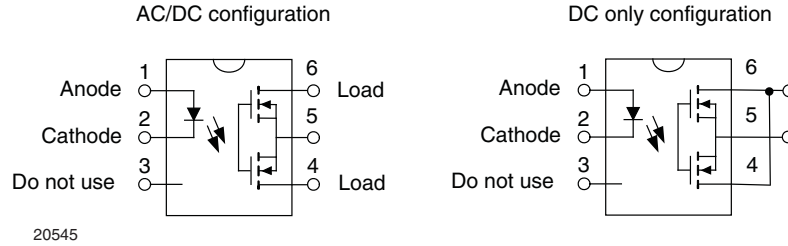


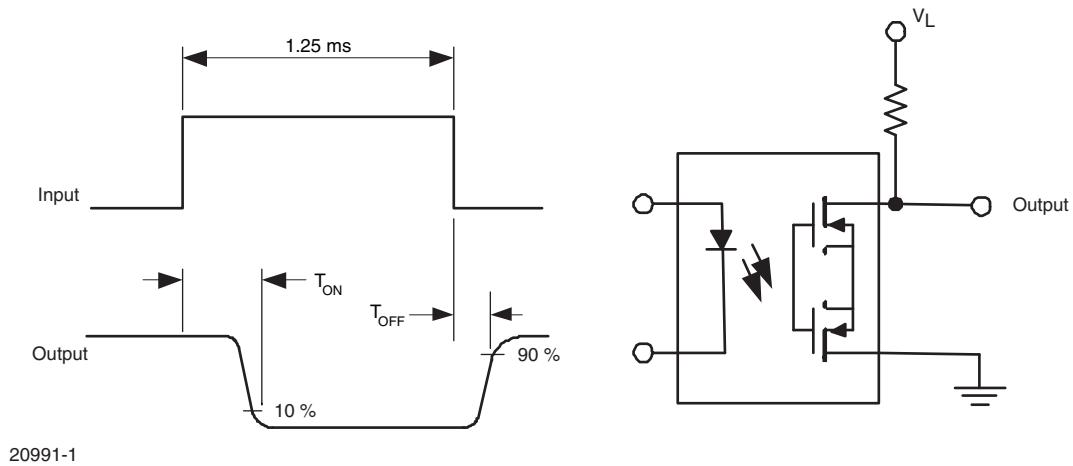
Fig. 1 - Load Current (AC/DC) vs. Temperature



## PIN CONFIGURATION



| SWITCHING CHARACTERISTICS (AC/DC CONNECTION) |   |           |      |      |      |               |
|--|---|-----------|------|------|------|---------------|
| PARAMETER                                    | TEST CONDITION  | SYMBOL    | MIN. | TYP. | MAX. | UNIT          |
| Turn-on time                                 | $I_F = 10 \text{ mA}$ , $V_L = 30 \text{ V}$ , $I_L = 200 \text{ mA}$ | $t_{on}$  |      | 370  | 800  | $\mu\text{s}$ |
| Turn-off time                                | $I_F = 10 \text{ mA}$ , $V_L = 30 \text{ V}$ , $I_L = 200 \text{ mA}$ | $t_{off}$ |      | 50   | 800  | $\mu\text{s}$ |
| Turn-on time                                 | $I_F = 10 \text{ mA}$ , $V_L = 5 \text{ V}$ , $I_L = 1 \text{ A}$     | $t_{on}$  |      | 550  |      | $\mu\text{s}$ |
| Turn-off time                                | $I_F = 10 \text{ mA}$ , $V_L = 5 \text{ V}$ , $I_L = 1 \text{ A}$     | $t_{off}$ |      | 18   |      | $\mu\text{s}$ |



| SAFETY AND INSULATION RATINGS   |  |            |      |          |                |            |
|---|--|------------|------|----------|----------------|------------|
| PARAMETER   | TEST CONDITION   | SYMBOL     | MIN. | TYP.     | MAX.           | UNIT       |
| Climatic classification   | IEC 68 part 1  |            |      | 40/85/21 |                |            |
| Pollution degree  | DIN VDE 0109   |            |      | 2        |                |            |
| Tracking resistance (comparative tracking index)                                | Insulation group IIIa  | CTI        | 175  |          |                |            |
| Highest allowable overvoltage   | Transient overvoltage  | $V_{IOTM}$ | 8000 |          |                | $V_{peak}$ |
| Maximum working insulation voltage  | Recurring peak voltage   | $V_{IORM}$ | 890  |          |                | $V_{peak}$ |
| Insulation resistance at 25 °C  | $V_{IO} = 500\text{ V}$  | $R_{IS}$   |      |          | $\geq 10^{12}$ | $\Omega$   |
| Insulation resistance at $T_S$  | $V_{IO} = 500\text{ V}$  | $R_{IS}$   |      |          | $\geq 10^9$    | $\Omega$   |
| Insulation resistance at 100 °C   | $V_{IO} = 500\text{ V}$  | $R_{IS}$   |      |          | $\geq 10^{11}$ | $\Omega$   |
| Partial discharge test voltage  | Method b,<br>$V_{pd} = V_{IORM} \times 1.875$  | $V_{pd}$   |      |          | 1669           | $V_{peak}$ |
| Isolation test voltage  | 1 s  | $V_{ISO}$  |      |          | 5300           | $V_{RMS}$  |
| Safety limiting values -<br>maximum values allowed in the<br>event of a failure | Case temperature   | $T_{SI}$   |      | 165      |                | °C         |
|   | Input current  | $I_{SI}$   |      | 150      |                | mA         |
|   | Output power   | $P_{SO}$   |      | 400      |                | mW         |
| Minimum external air gap (clearance distance)                                   | Measured from input terminals to output terminals, shortest distance through air     |            |      | $\geq 7$ |                | mm         |
| Minimum external tracking (creepage distance)                                   | Measured from input terminals to output terminals, shortest distance path along body |            |      | $\geq 7$ |                | mm         |

**Note**

- This SSR is suitable for "safe electrical insulation" only within the safety ratings. Compliance with the safety ratings shall be ensured by means of protective circuits.

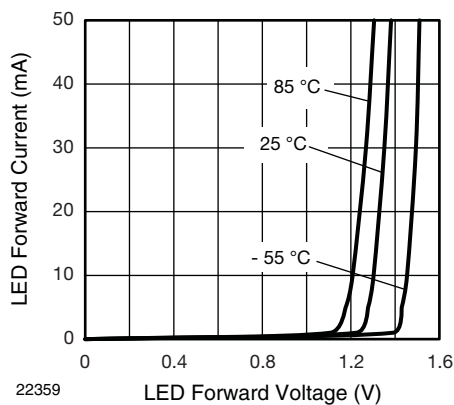
**TYPICAL CHARACTERISTICS** ( $T_{amb} = 25\text{ °C}$ , unless otherwise specified)


Fig. 2 - LED Forward Voltage vs. Current

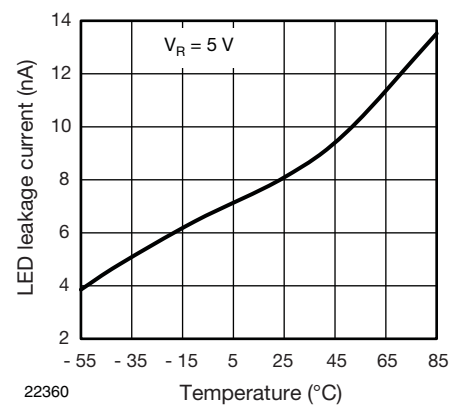


Fig. 3 - LED Leakage Current vs. Temperature

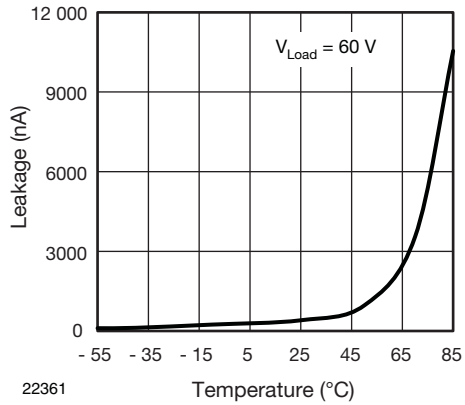


Fig. 4 - Output Leakage Current vs. Temperature

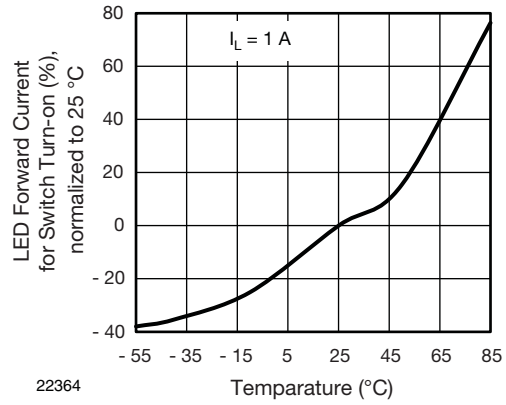


Fig. 7 - LED Current for Switch Turn-on vs. Temperature

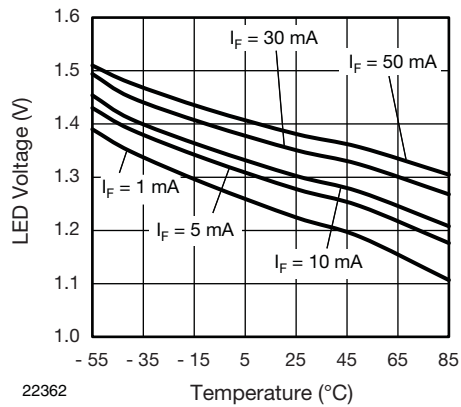


Fig. 5 - LED Voltage vs. Temperature

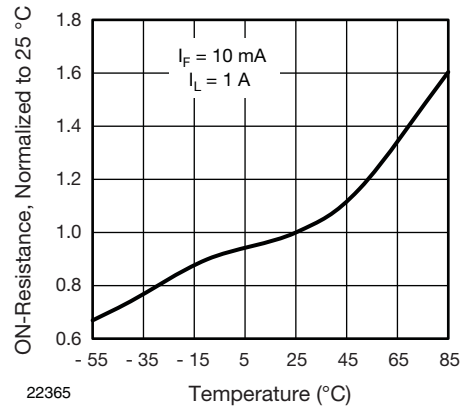


Fig. 8 - On-resistance vs. Temperature

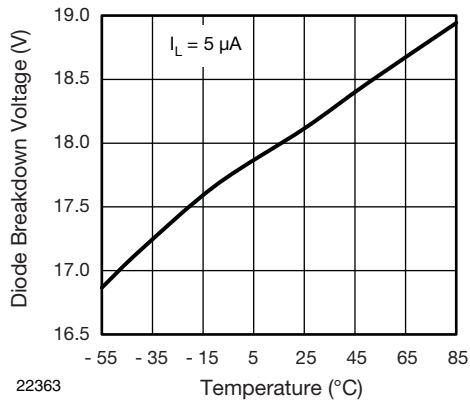


Fig. 6 - Diode Breakdown Voltage vs. Temperature

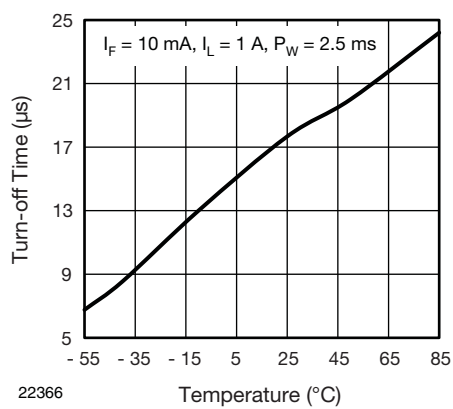


Fig. 9 - Turn-off Time vs. Temperature

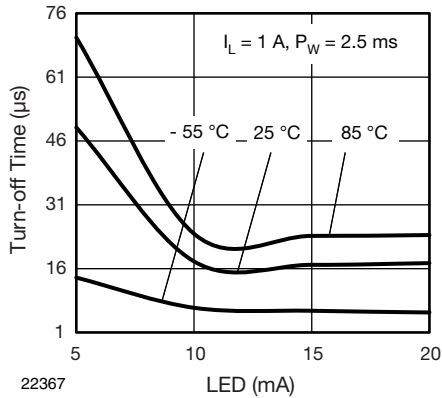


Fig. 10 - Turn-off Time vs. LED

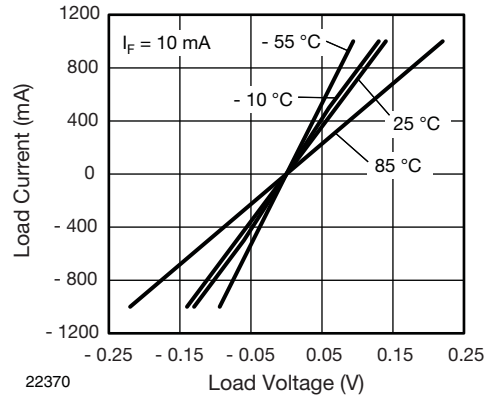


Fig. 13 - Load Current vs. Load Voltage

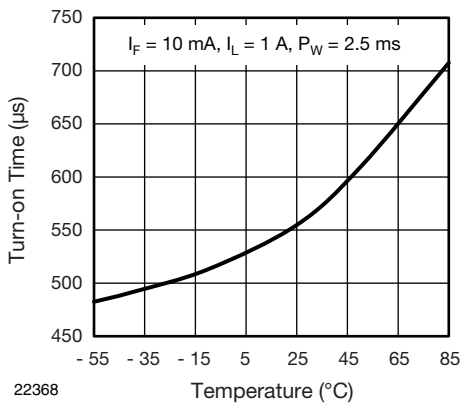


Fig. 11 - Turn-on Time vs. Temperature

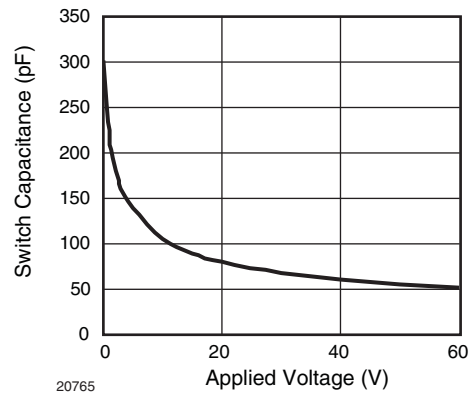


Fig. 14 - Switch Capacitance vs. Applied Voltage

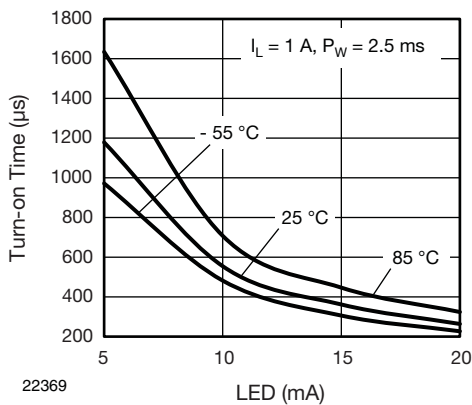


Fig. 12 - Turn-on Time vs. LED

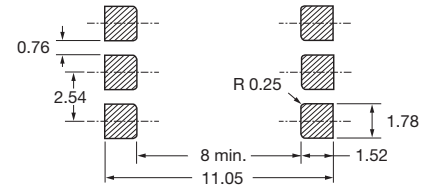
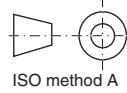
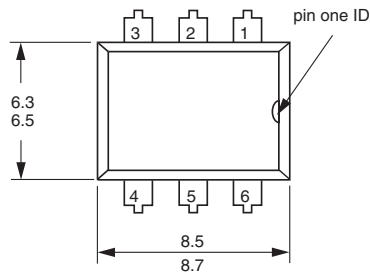
# VO14642AT, VO14642AABTR



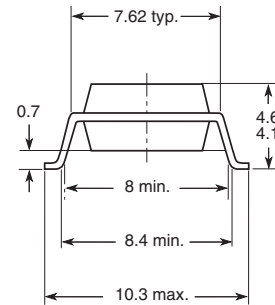
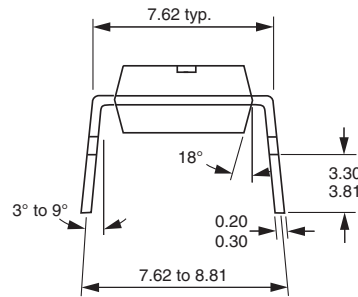
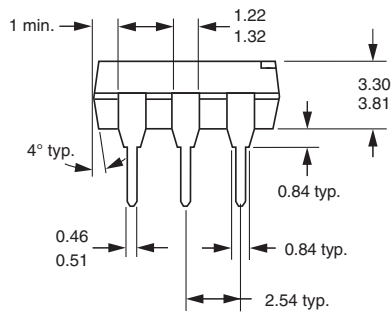
Vishay Semiconductors

1 Form A Solid State Relay

## PACKAGE DIMENSIONS in millimeters

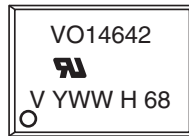


Option 7



i178014\_2

## PACKAGE MARKING



### Note

- Tape and reel suffix (TR) is not part of the package marking.





## Disclaimer

ALL PRODUCT, PRODUCT SPECIFICATIONS AND DATA ARE SUBJECT TO CHANGE WITHOUT NOTICE TO IMPROVE RELIABILITY, FUNCTION OR DESIGN OR OTHERWISE.

Vishay Intertechnology, Inc., its affiliates, agents, and employees, and all persons acting on its or their behalf (collectively, "Vishay"), disclaim any and all liability for any errors, inaccuracies or incompleteness contained in any datasheet or in any other disclosure relating to any product.

Vishay makes no warranty, representation or guarantee regarding the suitability of the products for any particular purpose or the continuing production of any product. To the maximum extent permitted by applicable law, Vishay disclaims (i) any and all liability arising out of the application or use of any product, (ii) any and all liability, including without limitation special, consequential or incidental damages, and (iii) any and all implied warranties, including warranties of fitness for particular purpose, non-infringement and merchantability.

Statements regarding the suitability of products for certain types of applications are based on Vishay's knowledge of typical requirements that are often placed on Vishay products in generic applications. Such statements are not binding statements about the suitability of products for a particular application. It is the customer's responsibility to validate that a particular product with the properties described in the product specification is suitable for use in a particular application. Parameters provided in datasheets and/or specifications may vary in different applications and performance may vary over time. All operating parameters, including typical parameters, must be validated for each customer application by the customer's technical experts. Product specifications do not expand or otherwise modify Vishay's terms and conditions of purchase, including but not limited to the warranty expressed therein.

Except as expressly indicated in writing, Vishay products are not designed for use in medical, life-saving, or life-sustaining applications or for any other application in which the failure of the Vishay product could result in personal injury or death. Customers using or selling Vishay products not expressly indicated for use in such applications do so at their own risk and agree to fully indemnify and hold Vishay and its distributors harmless from and against any and all claims, liabilities, expenses and damages arising or resulting in connection with such use or sale, including attorneys fees, even if such claim alleges that Vishay or its distributor was negligent regarding the design or manufacture of the part. Please contact authorized Vishay personnel to obtain written terms and conditions regarding products designed for such applications.

No license, express or implied, by estoppel or otherwise, to any intellectual property rights is granted by this document or by any conduct of Vishay. Product names and markings noted herein may be trademarks of their respective owners.



Компания «ЭлектроПласт» предлагает заключение долгосрочных отношений при поставках импортных электронных компонентов на взаимовыгодных условиях!

Наши преимущества:

- Оперативные поставки широкого спектра электронных компонентов отечественного и импортного производства напрямую от производителей и с крупнейших мировых складов;
- Поставка более 17-ти миллионов наименований электронных компонентов;
- Поставка сложных, дефицитных, либо снятых с производства позиций;
- Оперативные сроки поставки под заказ (от 5 рабочих дней);
- Экспресс доставка в любую точку России;
- Техническая поддержка проекта, помощь в подборе аналогов, поставка прототипов;
- Система менеджмента качества сертифицирована по Международному стандарту ISO 9001;
- Лицензия ФСБ на осуществление работ с использованием сведений, составляющих государственную тайну;
- Поставка специализированных компонентов (Xilinx, Altera, Analog Devices, Intersil, Interpoint, Microsemi, Aeroflex, Peregrine, Syfer, Eurofarad, Texas Instrument, Miteq, Cobham, E2V, MA-COM, Hittite, Mini-Circuits, General Dynamics и др.);

Помимо этого, одним из направлений компании «ЭлектроПласт» является направление «Источники питания». Мы предлагаем Вам помощь Конструкторского отдела:

- Подбор оптимального решения, техническое обоснование при выборе компонента;
- Подбор аналогов;
- Консультации по применению компонента;
- Поставка образцов и прототипов;
- Техническая поддержка проекта;
- Защита от снятия компонента с производства.



#### Как с нами связаться

**Телефон:** 8 (812) 309 58 32 (многоканальный)

**Факс:** 8 (812) 320-02-42

**Электронная почта:** [org@eplast1.ru](mailto:org@eplast1.ru)

**Адрес:** 198099, г. Санкт-Петербург, ул. Калинина, дом 2, корпус 4, литера А.