

APPLICATION TOOLING

Crimping tools and machines

Crimping tools and machines

The arrow mark indicates the press that is applicable to the applicator.

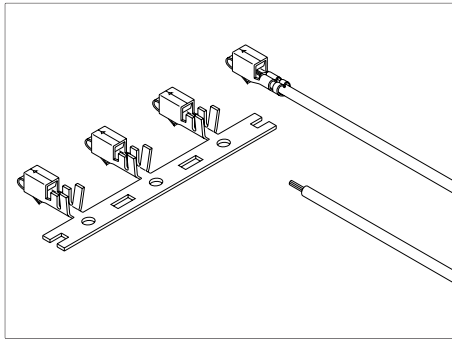

Strip-crimp applicator for side feeding terminals

MKS-SC

Crimping applicator for end-feeding terminals

MK-L

Semi-automatic press

Semi-automatic crimping machines (presses) contact a wire to a chain terminal each time a footswitch is pressed.

AP-K2N

- Dimensions: (W×L×H)280×480×505mm
- Weight: Approx. 90kg(198lb)
- Power source: 100V AC, Single-phase 50/60Hz
- Pressure output: 14.7kN[1,500kg(3307lb)]
- Dies: Applicator replacement

Crimping applicator for side-feeding terminals

MKS-L

Crimping applicator for end-feeding flag terminals

MKF-L









Compact crimping applicator for side-feeding terminals

MKS-LS

Hand tools

Crimping tools

Crimping tools

| Terminals and parts model number in alphabetical order | Hand tools | | | | | | Hand tools | | Extraction and Insertion tools | |
|--|---|---|---|---|---|--|-------------------------------------|-------------------------------------|---|---|
| | for chain terminals | for loose piece terminals | | | | | for loose piece terminals | | Extraction tool | Insertion tool |
| | YRS series | YC series | YRM series | YRF series | YRK series | YRK-EX series | | | | |
| |  |  |  |  |  |  | | |  |  |
| | Dimensions: (WxL) 59x224mm | Dimensions: (WxL) 70x296mm | Dimensions: (WxL) 59x224mm | Dimensions: (WxL) 70x295mm 80x305mm | Dimensions: (WxLxD) 75x314x25mm | Dimensions: (WxLxD) 75x314x25mm | | | | |
| | Crimping tools It is the manual tool that is convenient to terminate very small quantity of contacts for prototype or maintenance. It is composed of two crimping dies for the conductor and insulation, and can be crimp easily. YRK and YRK-EX can be used for mass-production. Note: (1) These tools are for prototype tooling or repair. (2) YC tool has two crimping sections (A and B). YRS tool has also two crimping sections by inverting upper dies. Be sure to check applicable wires before use. Since the dies are fixed, the crimping height cannot be adjusted. Therefore, some of the applicable wires described in this catalog may not be crimped properly. Before use, check for proper crimping (such as tensile strength, terminal/contact deformation). (3) These tools are not applicable to 2-wire crimping. (4) When hand crimping board-in terminals (SAN, SCN, SDN, SGN, SIN, SJN, SZN), care should be taken not to contaminate the solder tails of the terminals, as with greasy or oily fingers. If a solder problem arises, some cleaning of the tips of the terminal is advisable. (5) WC and JUC hand tools are provided by J.S.T.(U.K.) LTD. and contact them about the details of these hand tools. | | | | | | | | | |
| | YRS series | YC series | YRM series | YRF series | YRK · YRK-EX series | | WC & JUC series JUK's Hand Tools | Terminal in loose form model No. | | |
| JK-SP/SS2*** | YRS-370 | - | - | - | - | - | - | - | KEJ-0.7 for plug, KEJ-0.4 for socket | - |
| J-SP/SS1*** | YRS-440 | YC-440 | - | - | - | - | - | J-BP/BS1*** | DEJ-0.3 | - |
| J-SP/SS2*** | YRS-330 | - | - | - | - | - | - | - | DEJ-0.3 | - |
| LFO-1.0-250N | - | - | - | - | - | - | JUCS-FO | - | - | - |
| LFO-2.5-250N | - | - | - | - | - | - | JUCS-FO | - | - | - |
| MD-SP12** | YRS-470 | - | - | - | - | - | - | - | MEJ-06 | - |
| MD-SP22** | YRS-460 | - | - | - | - | - | - | - | MEJ-06 | - |
| RA-SC1290 | YRS-231 | - | YRM-232 YRM-233 | - | - | - | - | RA-BC12** | EJ-RA | - |
| RF-SC22** | - | - | YRM-230 | - | - | - | - | RF-BC22** | - | - |
| RPJ-SP/SS2331 | YRS-331 | - | - | - | - | - | - | - | EJ-RPJ | - |
| SAA-21(T)-** | - | YC-141 | - | - | - | - | - | LAA-21(T)-** | - | - |
| SAA-50(T)-** | - | YC-182 | - | - | - | - | - | LAA-50(T)-** | - | - |
| SAA-51(T)-** | - | YC-142 | - | - | - | - | - | LAA-51(T)-** | - | - |
| SAB-51(T)-** | - | YC-142 | - | - | - | - | - | LAB-51(T)-** | - | - |
| SACH-003G-P0.2 | YRS-1190 | - | - | - | - | - | - | - | - | - |
| SACH-002GU-P0.3 | YRS-858 | - | - | - | - | - | - | - | - | - |
| SAN-002T-0.8A SAN-002T-0.8K | YRS-220 | - | - | - | - | - | - | - | EJ-PH | - |
| SBH-001T-P0.5 | - | YC-670R | - | - | - | - | WC-670 | BBH-001T-P0.5 | - | - |
| SBHL-002T-P0.5 | YRS-857 | - | - | - | - | - | - | - | - | - |
| SBHM-001T-P0.5 | - | YC-670R | - | - | - | - | - | BBHM-001T-P0.5 | EJ-BHMR | - |
| SBHS-002T-P0.5A | YRS-852 | - | - | - | - | - | - | - | EJ-BHS2 | - |
| SBHS-002T-P0.5A | - | - | - | - | - | - | - | - | EJ-BHS2 | - |
| SBHSM-002T-P0.5 | YRS-854 | - | - | - | - | - | - | - | EJ-BHSW | - |
| SBHT-002T-P0.5 | YRS-856 YRS-857 | - | - | - | - | - | - | - | EJ-BHT | - |
| SBN-001T-1.0 | YRS-170 | YC-170R | - | - | - | - | - | BBN-001T-1.0 | - | - |
| SCN-001T-1.0K SCN-001T-P1.0 | YRS-191 | YC-191R | - | - | - | - | WC-191 | BCN-001T-1.0K BCN-001T-P1.0 | - | - |
| SCS-41T-2.3 | - | - | - | - | - | - | - | - | CSJ-23 | - |
| SCSN-41T-P2.3 | - | - | - | - | - | - | - | - | EJ-CSN | - |
| SCZH-002T-P0.5 | YRS-492 | - | - | - | - | - | - | - | - | - |

Note: Contact JST for wire range.

Crimping tools

| Terminals and parts model number in alphabetical order | Hand tools | | | | | | Hand tools | | Extraction and Insertion tools | |
|--|---------------------|---------------------------|------------|------------|---------------------|-------------------------------------|-------------------------------------|------------------|--------------------------------|---|
| | for chain terminals | for loose piece terminals | | | | for loose piece terminals | | Extraction tool | Insertion tool | |
| | YRS series | YC series | YRM series | YRF series | YRK · YRK-EX series | WC & JUC series JUK's Hand Tools | Terminal in loose form model No. | | | |
| SDF-01T-1.0A | - | YC-045 | - | - | - | - | - | LDF-01T-1.0A | - | - |
| SDF-01T-1.3AS | - | YC-045 | - | - | - | - | - | LDF-01T-1.3AS | - | - |
| SDN-21T-P1.5 | - | YC-600R | - | - | - | - | - | BDN-21T-P1.5 | - | - |
| SDY-01T-P1.6ASV | - | YC-525R | - | - | - | - | - | BDY-01T-P1.6ASV | SLJ-1.4 | - |
| SEH-001T-P0.6 | YRS-260 | YC-260R | - | - | - | - | WC-260 | BEH-001T-P0.6 | EJ-PH | - |
| SEH-001T-P0.6L | - | - | - | - | - | - | - | - | EJ-PH | - |
| SEH-002T-P0.6L | - | - | - | - | - | - | - | - | EJ-PH | - |
| SEH-003T-P0.6L | - | - | - | - | - | - | - | - | EJ-PH | - |
| SF1F-002(*)-P0.6 | - | - | - | - | YRK-1220 | - | - | - | EJ-JFAJ1100 | - |
| SF1M-002(*)-M0.6A | - | - | - | - | YRK-1220 | - | - | - | EJ-JFAJ1100 | - |
| SF1F-21(*)-P0.6 | - | - | - | - | YRK-1210 | - | - | - | EJ-JFAJ1100 | - |
| SF1M-21(*)-M0.6A | - | - | - | - | YRK-1210 | - | - | - | EJ-JFAJ1100 | - |
| SF3F-002(*)-P2.0 | - | - | - | YRF-882 | YRK-8821 | - | - | BF3F-002(*)-P2.0 | EJ-JFAJ3 | - |
| SF3F-01(*)-P2.0 | - | - | - | YRF-881 | YRK-8811 | - | - | BF3F-01(*)-P2.0 | EJ-JFAJ3 | - |
| SF3M-01(*)-M2.0N | - | - | - | YRF-881 | YRK-8811 | - | - | BF3M-01(*)-M2.0N | EJ-JFAJ3 | - |
| SF3F-41(*)-P2.0 | - | - | - | YRF-880 | YRK-8801 | - | - | LF3F-41(*)-P2.0 | EJ-JFAJ3 | - |
| SF3M-41(*)-M2.0N | - | - | - | YRF-880 | YRK-8801 | - | - | LF3M-41(*)-M2.0N | EJ-JFAJ3 | - |
| SF3F-71(*)-P2.0 | - | - | - | YRF-1070 | YRK-1071 | - | - | BF3F-71(*)-P2.0 | EJ-JFAJ3 | - |
| SF3M-71(*)-M2.0N | - | - | - | YRF-1071 | YRK-1071 | - | - | BF3M-71(*)-M2.0N | EJ-JFAJ3 | - |
| SFO-41(T)-187N(-8) | - | YC-271 | - | - | - | - | - | LFO-41(T)-187N | - | - |
| SFO-61(T)-250A | - | YC-270 | - | - | - | - | - | LFO-61(T)-250A | - | - |
| SFPS-61T-250 | - | YC-272 | - | - | - | - | - | LFPS-61(T)-250 | - | - |
| SFT-61T-250N | - | YC-510 | - | - | - | - | - | LFT-61T-250N | - | - |
| SGF-41(T)-4 | - | YC-055 | - | - | - | - | - | LGF-41(T)-4 | - | - |
| SGF-51(T)-5 | - | YC-065 | - | - | - | - | - | LGF-51(T)-5 | - | - |
| SGM-51T-5 | - | YC-056 | - | - | - | - | - | LGM-51T-5 | - | - |
| SHCM-A03T-P025 | YRS-960 | - | - | - | - | - | WC-SHCM-A03 | - | - | - |
| SHF-001T-0.8BS | YRS-122 | YC-122R | - | - | - | - | WC-122 | BHF-001T-0.8BS | EJ-SMP | - |
| SHF-002T-0.8BS | YRS-300 | - | - | - | - | - | - | - | EJ-SMP | - |
| SHIF-01T-P0.5 | - | YC-986R | - | - | - | - | - | - | EJ-HILP | - |
| SHIF-21T-P0.5 | - | YC-995R | - | - | - | - | - | - | EJ-HILP | - |
| SHIM-01T-P0.5 | - | YC-986R | - | - | - | - | - | - | EJ-HILR | - |
| SHIM-21T-P0.5 | - | YC-995R | - | - | - | - | - | - | EJ-HILR | - |
| SHR-001T-P0.6 | YRS-580 | YC-580R | - | - | - | - | - | BHR-001T-P0.6 | - | - |
| SIM-01(T)-110A | - | YC-054 | - | - | - | - | - | LIM-01(T)-110A | - | - |
| SIM-1.0-250D/N | - | - | - | - | - | - | JUCS-IM | - | - | - |
| SIM-2.5-250D/N | - | - | - | - | - | - | JUCS-IM | - | - | - |
| SIM-41(T)-110B | - | YC-067 | - | - | - | - | - | LIM-41(T)-110B | - | - |
| SIM-51(T)-250N | - | YC-321 | - | - | - | - | - | LIM-51(T)-250N | - | - |
| SIN-001T-1.2 | YRS-034 | - | - | - | - | - | - | - | - | - |
| SIN-002T-1.0S | YRS-035 | - | - | - | - | - | - | - | - | - |
| SIN-01T-1.2 | - | YC-340R | - | - | - | - | - | LIN-01T-1.2 | - | - |
| SIN-01T-1.8 | - | YC-032 | - | - | - | - | - | LIN-01T-1.8 | - | - |
| SIN-01T-1.8N | - | YC-032 | - | - | - | - | - | LIN-01T-1.8N | - | - |
| SIN-21T-1.8 | - | YC-350 | - | - | - | - | - | LIN-21T-1.8 | - | - |
| SIN-21T-1.8S | - | YC-570 YC-571 | - | - | - | - | - | LIN-21T-1.8S | - | - |
| SIN-61T-2.6S | - | YC-560 | - | - | - | - | - | LIN-61T-2.6S | - | - |
| SIN-81T-3.6S | - | YC-940 | - | - | - | - | - | LIN-81T-3.6S | - | - |

Note: Contact JST for wire range.

Crimping tools

| Terminals and parts model number in alphabetical order | Hand tools | | | | | Hand tools | | | Extraction and Insertion tools | |
|--|---------------------|---------------------------|------------|------------|---------------------|-------------------------------------|----------------------------------|-----------|--------------------------------|----------------|
| | for chain terminals | for loose piece terminals | | | | for loose piece terminals | | | Extraction tool | Insertion tool |
| | YRS series | YC series | YRM series | YRF series | YRK · YRK-EX series | WC & JUC series JUK's Hand Tools | Terminal in loose form model No. | | | |
| SJ2F-002GF-P1.0 | YRS-8851 | -- | -- | -- | YRK-8851 | -- | -- | EJ-JFAJ2N | -- | |
| SJ2M-002GF-M1.0N | YRS-8851 | -- | -- | -- | YRK-8851 | -- | -- | EJ-JFAJ2N | -- | |
| SJ2F-01GF-P1.0 | YRS-8861 | -- | -- | -- | YRK-8861 | -- | -- | EJ-JFAJ2N | -- | |
| SJ2M-01GF-M1.0N | YRS-8861 | -- | -- | -- | YRK-8861 | -- | -- | EJ-JFAJ2N | -- | |
| SJ2M-01GF-M1.0S | YRS-8861 | -- | -- | -- | YRK-8861 | -- | -- | EJ-JFAJ2N | -- | |
| SJ2F-21GF-P1.0 | -- | -- | -- | YRF-1120 | YRK-1120 | -- | LJ2F-21GF-P1.0 | EJ-JFAJ2N | -- | |
| SJ2M-21GF-M1.0N | -- | -- | -- | YRF-1120 | YRK-1120 | -- | LJ2M-21GF-M1.0N | EJ-JFAJ2N | -- | |
| SJ4F-71GF-M3.0 | -- | -- | -- | YRF-1130 | -- | -- | BJ4F-71GF-M3.0 | EJ-JFAJ4 | -- | |
| SJ4F-81GF-M3.0 | -- | -- | -- | YRF-1370 | -- | -- | BJ4F-81GF-M3.0 | EJ-JFAJ4 | -- | |
| SJ5F-71GF-M6.5 | -- | -- | -- | YRF-888 | -- | -- | LJ5F-71GF-M6.5 | EJ-JFAJ5 | -- | |
| SJ5M-71GF-M6.5 | -- | -- | -- | YRF-888 | -- | -- | LJ5M-71GF-M6.5 | EJ-JFAJ5 | -- | |
| SJ5F-81GF-M6.5 | -- | -- | -- | YRF-889 | -- | -- | LJ5F-81GF-M6.5 | EJ-JFAJ5 | -- | |
| SJ5M-81GF-M6.5 | -- | -- | -- | YRF-889 | -- | -- | LJ5M-81GF-M6.5 | EJ-JFAJ5 | -- | |
| SJ5F-91GF-M6.5 | -- | -- | -- | -- | -- | -- | LJ5F-91GF-M6.5 | EJ-JFAJ5 | -- | |
| SJ5M-91GF-M6.5 | -- | -- | -- | -- | -- | -- | LJ5M-91GF-M6.5 | EJ-JFAJ5 | -- | |
| SJN-001PT-0.9 | YRS-1181 | -- | -- | -- | -- | -- | -- | -- | -- | |
| SJN-002PT-0.9 | YRS-036 | -- | -- | -- | -- | -- | -- | -- | -- | |
| SLC-21T-2.0 | -- | YC-310 | -- | -- | -- | WC-310 | LLC-21T-2.0 | EJ-LC | -- | |
| SLC-22T-2.0 | -- | -- | -- | -- | -- | -- | -- | EJ-LC | -- | |
| SLC-001T-P2.0 | -- | -- | -- | -- | -- | -- | -- | EJ-LCL | -- | |
| SLC-02T-P2.0 | -- | -- | -- | -- | -- | -- | -- | EJ-LCL | -- | |
| SLF/M-01T-P1.3E | -- | YC-202 | YRM-201 | -- | -- | WC-202 | LLF/M-01T-P1.3E | LEJ-13 | LIT-2013 | |
| SLF/M-41T-P1.3E | -- | YC-203 | -- | -- | -- | WC-203 | LLF/M-41T-P1.3E | LEJ-13 | -- | |
| SMF-01T-1.0 | -- | YC-081 | -- | -- | -- | -- | LMF-01T-1.0 | -- | -- | |
| SMF-01T-1.3 | -- | YC-082 | -- | -- | -- | -- | LMF-01T-1.3 | -- | -- | |
| SMM-003T-P0.5 | YRS-800 | -- | -- | -- | -- | WC-800 | -- | -- | -- | |
| SMR-001T-0.6 | YRS-580 | YC-580R | -- | -- | -- | -- | BMR-001T-0.6 | -- | -- | |
| SOM-21(T)-187 | -- | YC-680 | -- | -- | -- | -- | LOM-21(T)-187 | -- | -- | |
| SOM-51(T)-250 | -- | YC-066 | -- | -- | -- | WC-066 | LOM-51(T)-250 | -- | -- | |
| SOTZP-002GD-P0.18 | -- | -- | -- | -- | -- | -- | -- | EJ-OTZS | -- | |
| SPA-001T-P0.5 | -- | YC-610R YC-611R | -- | -- | -- | -- | BPA-001T-P0.5 | EJ-PH | -- | |
| SPAL-001T-P0.5 | -- | YC-610R YC-611R | -- | -- | -- | -- | BPAL-001T-P0.5 | EJ-PAL | -- | |
| SPAL-002T-P0.5 | YRS-1340 | -- | -- | -- | -- | -- | -- | EJ-PAL | -- | |
| SPB-1.0-250N-S | -- | -- | -- | -- | -- | JUCS-PB | -- | -- | -- | |
| SPB-2.5-250N-S | -- | -- | -- | -- | -- | JUCS-PB | -- | -- | -- | |
| SPF-01T-2.5C | -- | YC-043R | -- | -- | -- | -- | LPF-01T-2.5C | -- | -- | |
| SPH-001T-P0.5L | YRS-245 | -- | -- | -- | -- | -- | -- | -- | -- | |
| SPH-002T-P0.5L | YRS-241 | -- | -- | -- | -- | -- | -- | EJ-PH | -- | |
| SPH-002T-P0.5S | YRS-240 | -- | YRM-240 | -- | -- | WC-240 | BPH-002T-P0.5S | EJ-PH | -- | |
| SPH-004T-P0.5S | YRS-243 | -- | -- | YRS-243 | -- | -- | -- | EJ-PH | -- | |
| SPHD-001T-P0.5 | -- | YC-610R YC-611R | -- | -- | -- | WC-610 | BPHD-001T-P0.5 | EJ-PHD-RB | -- | |
| SPHD-002T-P0.5 | YRS-620 | -- | YRM-620 | -- | -- | WC-620 | BPHD-002T-P0.5 | EJ-PHD-RB | -- | |
| SPLI-002T-P0.5 | YRS-1410 | -- | -- | -- | -- | -- | -- | -- | -- | |
| SPND-001T-C0.5 | YRS-1091 | -- | -- | -- | -- | -- | -- | EJ-PND | -- | |
| SPND-002T-C0.5 | YRS-1090 | -- | -- | -- | -- | -- | -- | EJ-PND | -- | |

Note: Contact JST for wire range.

Crimping tools

| Terminals and parts model number in alphabetical order | Hand tools | | | | | Hand tools | | | Extraction and Insertion tools | |
|--|---------------------|---------------------------|------------|------------|---------------------|-------------------------------------|----------------------------------|-----------------|--------------------------------|----------------|
| | for chain terminals | for loose piece terminals | | | | for loose piece terminals | | | Extraction tool | Insertion tool |
| | YRS series | YC series | YRM series | YRF series | YRK · YRK-EX series | WC & JUC series JUK's Hand Tools | Terminal in loose form model No. | | | |
| SPS-01T-110 | - | YC-740 | - | - | - | | WC-740 | LPS-01T-110 | - | - |
| SPS-01T-187(-8) | - | YC-730 YC-731 | - | - | - | | WC-730 | LPS-01T-187(-8) | EJ-PS187 | - |
| SPS-21T-205(-5) | - | YC-760 | - | - | - | | - | LPS-21T-205(-5) | - | - |
| SPS-21T-250 | - | YC-780 | - | - | - | | WC-780 | LPS-21T-250 | EJ-PS250 | - |
| SPS-21T-250S | - | YC-780 | - | - | - | | WC-780 | LPS-21T-250S | EJ-PS250 | - |
| SPS-41T-110 | - | YC-750 YC-751 | - | - | - | | WC-750 | LPS-41T-110 | - | - |
| SPS-51T-187(-8) | - | YC-710 YC-711 | - | - | - | | WC-710 | LPS-51T-187(-8) | EJ-PS187 | - |
| SPS-51T-205 | - | YC-770 YC-771 | - | - | - | | - | LPS-51T-205 | - | - |
| SPS-61T-250 | - | YC-720 | - | - | - | | WC-720 | LPS-61T-250 | EJ-PS250 | - |
| SPS-61T-250S | - | YC-721 | - | - | - | | - | LPS-61T-250S | EJ-PS250 | - |
| SPS-91T-250 | - | - | - | YRF-790 | - | | - | BPS-91T-250 | EJ-PS250 | - |
| SPS-91T-250S | - | - | - | YRF-791 | - | | - | BPS-91T-250S | EJ-PS250 | - |
| SPUD-001T-P0.5 | YRS-1320 | - | - | - | - | | - | - | EJ-PUD | - |
| SPUD-002T-P0.5 | - | - | - | - | - | | - | - | EJ-PUD | - |
| SPXA-001T-P0.6 | - | - | - | - | - | | - | - | EJ-PXA | - |
| SRA-20(T)-** | - | YC-181 | - | - | - | | - | LRA-20(T)-** | - | - |
| SRA-21(T)-** | - | YC-141 | - | - | - | | - | LRA-21(T)-** | - | - |
| SRA-50(T)-** | - | YC-182 | - | - | - | | - | LRA-50(T)-** | - | - |
| SRA-51(T)-** | - | YC-142 | - | - | - | | - | LRA-51(T)-** | - | - |
| SRB-1.0(-) | - | - | - | - | - | | JUCS-RB/RT | - | - | - |
| SRB-2.5(-) | - | - | - | - | - | | JUCS-RB/RT | - | - | - |
| SRB-51(T)-** | - | YC-142 | - | - | - | | - | LRB-51(T)-** | - | - |
| SRC-01(T)-** | - | YC-033 | - | - | - | | - | LRC-01(T)-** | - | - |
| SRC-50(T)-** | - | YC-183 | - | - | - | | - | LRC-50(T)-** | - | - |
| SRC-51(T)-** | - | YC-142 | - | - | - | | - | LRC-51(T)-** | - | - |
| SRF-51(T)-** | - | YC-142 | - | - | - | | - | LRF-51(T)-** | - | - |
| SRT-1.0(-) | - | - | - | - | - | | JUCS-RB/RT | - | - | - |
| SRT-2.5(-) | - | - | - | - | - | | JUCS-RB/RT | - | - | - |
| SRT-51T-** | - | YC-143R | - | - | - | | - | LRT-51T-** | - | - |
| SRWF-01GG-M0.6 | - | - | - | - | - | | - | - | EJ-RPZ | - |
| SRWM-01GG-S0.6 | - | - | - | - | - | | - | - | EJ-RPZ | - |
| SRWF-21GG-M0.6 | - | - | - | - | - | | - | - | EJ-RPZ | - |
| SRWM-21GG-S0.6 | - | - | - | - | - | | - | - | EJ-RPZ | - |
| SRWF-61GG-M0.6 | - | YC-840R | - | - | - | | - | BRWF-61GG-M0.6 | EJ-RPZ | - |
| SRWM-61GG-S0.6 | - | YC-840R | - | - | - | | - | BRWM-61GG-S0.6 | EJ-RPZ | - |
| SSFH-001T-P0.5 | - | - | - | - | - | | - | - | EJ-SFH | - |
| SSFH-002T-P0.5 | - | - | - | - | - | | - | - | EJ-SFH | - |
| SSH-003T-P0.2-H | YRS-859 | - | - | - | - | | WC-SH2832 | - | - | - |
| SSH-003GA-P0.2 | YRS-859 | - | - | - | - | | WC-SH2832 | - | - | - |
| SSHL-002T-P0.2 | YRS-1140 | - | - | - | - | | WC-GH2630 | - | - | - |
| SSHL-003T-P0.2 | YRS-859 | - | - | - | - | | WC-SH2832 | - | - | - |
| SSHL-003GA1-P0.2 | YRS-859 | - | - | - | - | | WC-SH2832 | - | - | - |
| SSF/M-01T-P1.4 | - | YC-500 | - | - | - | | - | BSF/M-01T-P1.4 | SLJ-1.4 | ITBL-08V |
| SSF/M-21T-P1.4 | - | YC-550 | - | - | - | | WC-550 | BSF/M-21T-P1.4 | SLJ-1.4 | - |
| STI-01(T)-110N | - | YC-041 | - | - | - | | - | LTI-01(T)-110N | - | - |

Note: Contact JST for wire range.

Crimping tools

| Terminals and parts model number in alphabetical order | Hand tools | | | | | Hand tools | | | Extraction and Insertion tools | |
|--|---------------------|-------------------------------|------------------------|------------|---------------------|-------------------------------------|----------------------------------|--------------------|--------------------------------|----------------|
| | for chain terminals | for loose piece terminals | | | | for loose piece terminals | | | Extraction tool | Insertion tool |
| | YRS series | YC series | YRM series | YRF series | YRK · YRK-EX series | WC & JUC series JUC's Hand Tools | Terminal in loose form model No. | | | |
| STI-1.0-250D/N | - | - | - | - | - | - | JUCS-TI | - | - | - |
| STI-2.5-250D/N | - | - | - | - | - | - | JUCS-TI | - | - | - |
| STI-41(T)-110N | - | YC-063 | - | - | - | - | - | LTI-41(T)-110N | - | - |
| STI-51(T)-250N | - | YC-322 | - | - | - | - | - | LTI-51(T)-250N | - | - |
| STO-01(T)-110N(-8) | - | YC-041 | - | - | - | - | - | LTO-01(T)-110N(-8) | - | - |
| STO-01(T)-187N(-8) | - | YC-042 | - | - | - | - | - | LTO-01(T)-187N(-8) | - | - |
| STO-0.25-110N | - | YC-810 | - | - | - | - | - | - | - | - |
| STO-0.5-110N | - | YC-820 | - | - | - | - | JUCS-05110 | - | - | - |
| STO-1.0-110N | - | - | - | - | - | - | JUCS-2.8/4.8 | - | - | - |
| STO-1.0-187N | - | - | - | - | - | - | JUCS-2.8/4.8 | - | - | - |
| STO-1.0-250N | - | - | - | - | - | - | JUCS-6.3 | - | - | - |
| STO-2.5-250N | - | - | - | - | - | - | JUCS-6.3 | - | - | - |
| STO-21(T)-205N | - | YC-053 | - | - | - | - | - | LTO-21(T)-205N | - | - |
| STO-21(T)-250N | - | YC-102 | - | - | - | - | - | LTO-21(T)-250N | - | - |
| STO-41(T)-110N(-8) | - | YC-062 | - | - | - | - | - | LTO-41(T)-110N(-8) | - | - |
| STO-41(T)-187N(-8) | - | YC-051 | - | - | - | - | - | LTO-41(T)-187N(-8) | - | - |
| STO-41T-187S | - | YC-064 | - | - | - | - | - | LTO-41T-187S | EJ-187S | - |
| STO-61(T)-250N | - | YC-047 | - | - | - | - | - | LTO-61(T)-250N | - | - |
| STO-81(T)-250N | - | YC-280 | - | YRF-280 | - | - | - | LTO-81(T)-250N | - | - |
| STS/D-002GG-P0.6 | YRS-1360 | - | - | - | - | - | - | - | EJ-TSD | - |
| SVA-41T-P1.1 | - | YC-450 | - | - | - | - | - | BVA-41T-P1.1 | - | - |
| SVF-01T-1.5A | - | YC-044 | - | - | - | - | - | LVF-01T-1.5A | - | - |
| SVF-01T-1.5N | - | YC-151 | - | - | - | - | - | LVF-01T-1.5N | EJ-SV | - |
| SVF-01T-2.36N | - | YC-152 | - | - | - | - | - | LVF-01T-2.36N | EJ-LV | - |
| SVF-42T-P2.0 | - | YC-592 | - | - | - | - | WC-592 | BVF-42T-P2.0 | VLJ-20 | - |
| SVM-42T-P2.0 | - | YC-593 | - | - | - | - | WC-592 | BVM-42T-P2.0 | VLJ-20 | - |
| SVF/M-61T-P2.0 | - | YC-590 | - | YRF-590 | - | - | WC-590 | BVF/M-61T-P2.0 | VLJ-20 | - |
| SVF/M-81T-P2.0 | - | - | - | YRF-591 | - | - | WC-591 | BVF/M-81T-P2.0 | VLJ-20 | - |
| SVH-21T-P1.1 | - | YC-160R YC-161R YC-164R | YRM-160 YRM-164 | - | - | - | WC-160 | BVH-21T-(P)1.1 | EJ-NV | - |
| SVH-41T-P1.1 | - | YC-930R YC-931R | - | - | - | - | WC-930 | BVH-41T-P1.1 | EJ-NV | - |
| SVT-41T-P1.1 | - | YC-630 | - | - | - | - | - | BVT-41T-P1.1 | EJ-VT | - |
| SVU-21T-P0.6 | - | YC-990R | - | - | - | - | - | BVU-21T-P0.6 | EJ-VU4 | - |
| SVYF-61T-P0.5A | - | - | - | YRF-536 | - | - | - | - | - | - |
| SWPJT-21T-P0.5 | - | - | - | - | - | - | - | - | EJ-WPJ | - |
| SWPJT-21T-P0.5A | - | - | - | - | - | - | - | - | EJ-WPJ | - |
| SWPJR-21T-M0.5 | - | - | - | - | - | - | - | - | EJ-WPJ | - |
| SWPKP-21T-0.6 | - | - | - | YRF-1051 | - | - | - | BWPKP-21T-0.6 | - | - |
| SWPKR-21T-0.6 | - | - | - | YRF-1050 | - | - | - | BWPKR-21T-0.6 | - | - |
| SWPR-001T-P025 | YRS-980 | - | - | - | - | - | WC-JWPF | - | EJ-JWPF | - |
| SWPT-001T-P025 | YRS-980 | - | - | - | - | - | WC-JWPF | - | EJ-JWPF | - |
| SXA-01T-P0.6 | YRS-701 | YC-701R | - | - | - | - | WC-700M | BXA-01T-P0.6 | EJ-XAG,EJ-XMP | - |
| SXA-001T-P0.6 | YRS-692 | YC-692R | - | - | - | - | - | BXA-001T-P0.6 | EJ-XMP, EJ-XMR | IT-XA |
| SXA-001T-P0.6L | YRS-691 | - | - | - | - | - | WC-691 | - | - | - |

Note: Contact JST for wire range.

Crimping tools

| Terminals and parts model number in alphabetical order | Hand tools | | | | | | Hand tools | | Extraction and Insertion tools | |
|--|---------------------|---------------------------|------------|------------|---------------------|-------------------------------------|----------------------------------|------------------|--------------------------------|-------|
| | for chain terminals | for loose piece terminals | | | | for loose piece terminals | | Extraction tool | Insertion tool | |
| | YRS series | YC series | YRM series | YRF series | YRK · YRK-EX series | WC & JUC series JUK's Hand Tools | Terminal in loose form model No. | | | |
| SXAM-01T-P0.6 | YRS-701 | YC-701R | - | - | - | - | WC-700M | BXAM-01T-P0.6 | EJ-XAW | - |
| SXAM-001T-P0.6 | YRS-692 | YC-692R | - | - | - | - | - | BXAM-001T-P0.6 | EJ-XAW | - |
| SXF-01T-P0.7 | - | YC-251 | - | - | - | - | - | BXF-01T-(P)0.7 | LEJ-7 | - |
| SXF-41T-P0.7 | - | YC-252 | - | - | - | - | - | BXF-41T-(P)0.7 | LEJ-7 | - |
| SXH-001T-P0.6 | YRS-110 | YC-110R YC-111R | - | - | - | - | WC-110 | BXH-001T-P0.6 | XJ-06 | - |
| SXH-001T-P0.6N | - | - | - | - | - | - | - | - | XJ-06 | - |
| SXH-002T-P0.6 | YRS-480 | - | - | - | - | - | - | - | XJ-06 | - |
| SXM-01T-P0.6 | YRS-701 | YC-701R | - | - | - | - | - | BXM-01T-P0.6 | EJ-XAG,EJ-XMP | - |
| SXM-001T-P0.6 | YRS-692 | YC-692R | - | - | - | - | - | BXM-001T-P0.6 | EJ-XMP, EJ-XMR | IT-XA |
| SXNI-001T-P0.6 | YRS-1380 | - | - | - | - | - | - | - | - | - |
| SXNI-003T-P0.6 | YRS-1390 | - | - | - | - | - | - | - | - | - |
| SYF-001T-P0.6 | YRS-125 | - | - | - | - | - | - | - | - | - |
| SYF/M-01T-P0.5A | - | YC-520 | - | - | - | - | WC-520 | BYF/M-01T-P0.5A | YLJ-0.5 | - |
| SYF/M-41T-P0.5A | - | YC-530 | - | - | - | - | WC-530 | BYF/M-41T-P0.5A | YLJ-0.5 | - |
| SYF-61T-P0.5A | - | - | - | - | YRF-536 | - | - | - | - | - |
| SYM-001T-P0.6 | YRS-121 | YC-121R | - | - | - | - | WC-121 | BYM-001T-P0.6 | SMJ-06 | - |
| SYM-01T-P0.7 | - | YC-251 | - | - | - | - | - | BYM-01T-(P)0.7 | LEJ-7 | - |
| SYM-41T-P0.7 | - | YC-252 | - | - | - | - | - | BYM-41T-(P)0.7 | LEJ-7 | - |
| SZE-002T-P0.3 | YRS-1300 | - | - | - | - | - | - | - | - | - |
| SZE-003T-P0.3 | YRS-1330 | - | - | - | - | - | - | - | - | - |
| SZF/M-01T-P0.7 | - | YC-390R | - | - | - | - | - | BZF/M-01T-(P)0.7 | ZLJ-07S | - |
| SZF/M-41T-P0.7 | - | YC-380R | - | - | - | - | - | BZF/M-41T-(P)0.7 | ZLJ-07S | - |
| SZH-002T-P0.5 | YRS-491 | - | - | - | - | - | WC-491 | - | - | - |
| SZH-003T-P0.5 | YRS-490 | - | - | - | - | - | WC-490 | - | - | - |
| SZN-002T-P0.7K | YRS-541 | - | - | - | - | - | - | - | - | - |
| SZN-003T-P0.7K | YRS-540 | - | - | - | - | - | - | - | - | - |
| SZPD-002T-P0.3 | YRS-1460 | - | - | - | - | - | - | - | - | - |

Note: Contact JST for wire range.

YRK series hand crimping tools suitable for mass-production

- Crimping work, such as setting contacts to hand tools etc., is facilitated by using a strip contact to improve the productivity.
- A light operation enables to terminate the contact correctly, by adopting straight-ahead crimping.
- A structure, that the carrier of contact doesn't fly off, has been adopted to this tool.

Hand Crimping Tools YRK Standard type

- When exchanging the crimper, the crimping suitable for the wire specification can be conducted.
- Anvil is fixed to tool.



Dimensions: 75(W)×314(L)×25(D)mm
Weight: Approx. 800g (When assembling dies)

Contact and Applicable dies

| Series | Nominal | Contact Model No. | | Hand crimp tools | Model No. of crimper ^{*1} | Applicable wire size | | |
|------------------|-------------------|--------------------|--------------------|------------------|------------------------------------|----------------------|--------|----------------------|
| | | Receptacle | Tab | | | Marking | AWG | Insulation O.D. (mm) |
| J1000 Type II | L | SF1F-21 (*) -P0.6 | SF1M-21 (*) -M0.6A | YRK-1210 | LA / LB | LA | #22 | 1.58 |
| | | | | | | LB | KV0.75 | 1.90 |
| | | | | | LC / LD | LC | #20 | 1.76 |
| | | | | | | LD | #18 | 2.03 |
| J2000 | S | SJ2F-002GF-P1.0 | SJ2M-002GF-M1.0N | YRK-8851 | SA / SB | SA | #28 | 1.20 |
| | | | | | | SB | #24 | 1.43 |
| | M | SJ2F-01GF-P1.0 | SJ2M-01GF-M1.0N | YRK-8861 | MA / MB | MA | #24 | 1.43 |
| | | | | | | MB | #20 | 1.53 ^{*2} |
| L | SJ2F-21GF-P1.0 | SJ2M-21GF-M1.0N | YRK-1120 | LA / LB | LA | #22 | 1.58 | |
| | | | | | LB | #20 | 1.76 | |
| J300 | S | SF3F-002 (*) -P2.0 | — | YRK-8821 | SA / SB | SA | #28 | 1.20 |
| | | | | | | SB | #24 | 1.43 |
| | | | | | SC / SD | SC | #26 | 1.30 |
| | | | | | | SD | #24 | 1.11 |
| | M | SF3F-01 (*) -P2.0 | SF3M-01 (*) -M2.0N | YRK-8811 | MA / MB | MA | #24 | 1.43 |
| | | | | | | MB | #20 | 1.76 |
| | | | | | MC / MD | MC | #22 | 1.58 |
| | | | | | | MD | #20 | 2.56 |
| | L | SF3F-41 (*) -P2.0 | SF3M-41 (*) -M2.0N | YRK-8801 | LA / LB | LA | #20 | 1.76 |
| | | | | | | LB | #16 | 2.35 |
| | | | | | LC / LD | LC | #18 | 2.03 |
| | | | | | | LD | #18 | 2.83 |
| 2L | SF3F-71 (*) -P2.0 | SF3M-71 (*) -M2.0N | YRK-1071 | 2LA / 2LB | 2LA | #16 | 3.10 | |
| | | | | | 2LB | #14 | 3.30 | |

Note: 1. J1000 Finish(*): T..... Tin-plated
GC... Gold-plated
2. J300 Finish(*): GF... Nickel-undercoated, 0.38μm selective gold-plated
GI... Nickel-undercoated, 0.76μm selective gold-plated
T..... Tin-plated

3. The wear of parts is caused by using hand tool repeatedly.
Measure the crimping height daily and conduct periodical inspection of the wearing parts, such as ratchet, pin and so on.

*1... Crimper is either the pair of A and B or the pair of C and D.
*2... When using wire type UL 2517.

Dies replacement type hand crimping tools

YRK-EX

- High reliability of crimping is provided by choosing the crimper and anvil suitable for the wire specification.
- The crimping die can be easily exchanged by only insertion and extraction of pin.
- Common handle and crimping dies can be stored in One case and it is easy to carry.

Patent pending



Dimensions: 75(W)×314(L)×25(D)mm
Weight: Approx. 800g (When assembling dies)



Dimensions: 376(W)×295(L)×73(D)mm

Contact and Applicable dies

| Series | Nominal | Contact Model No. | | Crimper Model No. | Crimper ^{*1} | | | Anvil | Color mark | Common parts |
|------------------|-------------------|--------------------|--------------------|-------------------|-----------------------|--------|----------------------|-------|--------------|---|
| | | Receptacle | Tab | | Applicable wire size | | | | | |
| | | | | | Die mark | AWG | Insulation O.D. (mm) | | | |
| J1000 Type II | L | SF1F-21(*)-P0.6 | SF1M-21(*)-M0.6A | J1LA / B | A | #20 | 1.76 | J1LL | Yellow green | Handle unit Upper pin Lower pin Case |
| | | | | | B | #18 | 2.03 | | | |
| | | | | J1LC / D | C | #22 | 1.58 | | | |
| | | | | | D | KV0.75 | 1.90 | | | |
| J2000 | S | SJ2F-002GF-P1.0 | SJ2M-002GF-M1.0N | J2SA / B | A | #28 | 1.20 | J2SL | White | |
| | | | | | B | #24 | 1.43 | | | |
| | M | SJ2F-01GF-P1.0 | SJ2M-01GF-M1.0N | J2MA / B | A | #24 | 1.43 | J2ML | Purple | |
| | | | | | B | #20 | 1.53 ^{*2} | | | |
| | L | SJ2F-21GF-P1.0 | SJ2M-21GF-M1.0N | J2LA / B | A | #22 | 1.58 | J2LL | Orange | |
| | | | | | B | #20 | 1.76 | | | |
| J300 | S | SF3F-002 (*) -P2.0 | — | J3SA / B | A | #28 | 1.20 | J3SL | Yellow | |
| | | | | | B | #24 | 1.43 | | | |
| | | | | J3SC / D | C | #26 | 1.30 | | | |
| | | | | | D | #24 | 1.11 | | | |
| | M | SF3F-01 (*) -P2.0 | SF3M-01 (*) -M2.0N | J3MA / B | A | #24 | 1.43 | J3ML | Green | |
| | | | | | B | #20 | 1.76 | | | |
| | | | | J3MC / D | C | #22 | 1.58 | | | |
| | | | | | D | #20 | 2.56 | | | |
| | L | SF3F-41 (*) -P2.0 | SF3M-41 (*) -M2.0N | J3LA / B | A | #20 | 1.76 | J3LL | Red | |
| | | | | | B | #16 | 2.35 | | | |
| | | | | J3LC / D | C | #18 | 2.03 | | | |
| | | | | | D | #18 | 2.83 | | | |
| 2L | SF3F-71 (*) -P2.0 | SF3M-71 (*) -M2.0N | J32LA / B | A | #16 | 3.10 | J32LL | Blue | | |
| | | | | B | #14 | 3.30 | | | | |

Note: 1. J1000 Finish(*): T..... Tin-plated
GC... Gold-plated
2. J300 Finish(*): GF... Nickel-undercoated, 0.38μm selective gold-plated
GI... Nickel-undercoated, 0.76μm selective gold-plated
T..... Tin-plated

3. The wear of parts is caused by using hand tool repeatedly.
Measure the crimping height daily and conduct periodical inspection of the wearing parts, such as ratchet, pin and so on.

*1... Crimper is either the pair of A and B or the pair of C and D.
*2... When using wire type UL 2517.



Компания «ЭлектроПласт» предлагает заключение долгосрочных отношений при поставках импортных электронных компонентов на взаимовыгодных условиях!

Наши преимущества:

- Оперативные поставки широкого спектра электронных компонентов отечественного и импортного производства напрямую от производителей и с крупнейших мировых складов;
- Поставка более 17-ти миллионов наименований электронных компонентов;
- Поставка сложных, дефицитных, либо снятых с производства позиций;
- Оперативные сроки поставки под заказ (от 5 рабочих дней);
- Экспресс доставка в любую точку России;
- Техническая поддержка проекта, помощь в подборе аналогов, поставка прототипов;
- Система менеджмента качества сертифицирована по Международному стандарту ISO 9001;
- Лицензия ФСБ на осуществление работ с использованием сведений, составляющих государственную тайну;
- Поставка специализированных компонентов (Xilinx, Altera, Analog Devices, Intersil, Interpoint, Microsemi, Aeroflex, Peregrine, Syfer, Eurofarad, Texas Instrument, Miteq, Cobham, E2V, MA-COM, Hittite, Mini-Circuits, General Dynamics и др.);

Помимо этого, одним из направлений компании «ЭлектроПласт» является направление «Источники питания». Мы предлагаем Вам помощь Конструкторского отдела:

- Подбор оптимального решения, техническое обоснование при выборе компонента;
- Подбор аналогов;
- Консультации по применению компонента;
- Поставка образцов и прототипов;
- Техническая поддержка проекта;
- Защита от снятия компонента с производства.



Как с нами связаться

Телефон: 8 (812) 309 58 32 (многоканальный)

Факс: 8 (812) 320-02-42

Электронная почта: org@eplast1.ru

Адрес: 198099, г. Санкт-Петербург, ул. Калинина, дом 2, корпус 4, литера А.