



MCP6G01/1R/1U/2/3/4

110 μ A Selectable Gain Amplifier

Features

- 3 Gain Selections:
 - +1, +10, +50 V/V
- One Gain Select Input per Amplifier
- Rail-to-Rail Input and Output
- Low Gain Error: $\pm 1\%$ (max.)
- High Bandwidth: 250 kHz to 900 kHz (typ.)
- Low Supply Current: 110 μ A (typ.)
- Single Supply: 1.8V to 5.5V
- Extended Temperature Range: -40°C to $+125^{\circ}\text{C}$

Typical Applications

- A/D Converter Driver
- Industrial Instrumentation
- Bar Code Readers
- Metering
- Digital Cameras

Block Diagram



Description

The Microchip Technology Inc. MCP6G01/1R/1U/2/3/4 are analog Selectable Gain Amplifiers (SGA). They can be configured for gains of +1 V/V, +10 V/V, and +50 V/V through the Gain Select input pin(s). The Chip Select pin on the MCP6G03 can put it into shutdown to conserve power. These SGAs are optimized for single supply applications requiring reasonable quiescent current and speed.

The single amplifiers MCP6G01, MCP6G01R, MCP6G01U, and MCP6G03, are available in 5-pin SOT-23 package and the dual amplifier MCP6G02, are available in 8-pin SOIC and MSOP packages. The quad amplifier MCP6G04 is available in 14-pin SOIC and TSSOP packages. All parts are fully specified from -40°C to $+125^{\circ}\text{C}$.

Package Types

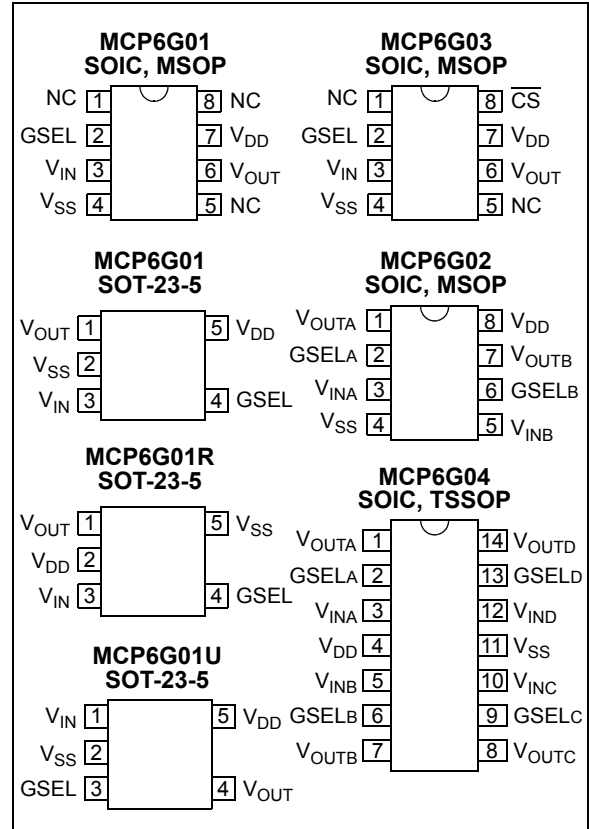

MCP6G01/1R/1U/2/3/4

1.0 ELECTRICAL CHARACTERISTICS

Absolute Maximum Ratings †

$V_{DD} - V_{SS}$	7.0V
Current at Analog Input Pin (V_{IN})	± 2 mA
Analog Input (V_{IN}) ††	$V_{SS} - 1.0V$ to $V_{DD} + 1.0V$
All other Inputs and Outputs	$V_{SS} - 0.3V$ to $V_{DD} + 0.3V$
Output Short Circuit Current	continuous
Current at Output and Supply Pins	± 30 mA
Storage Temperature	$-65^{\circ}C$ to $+150^{\circ}C$
Junction Temperature	$+150^{\circ}C$
ESD protection on all pins (HBM; MM)	≥ 4 kV; 200V

† **Notice:** Stresses above those listed under “Absolute Maximum Ratings” may cause permanent damage to the device. This is a stress rating only and functional operation of the device at those or any other conditions above those indicated in the operational listings of this specification is not implied. Exposure to maximum rating conditions for extended periods may affect device reliability.

†† See Section 4.1.4 “Input Voltage and Current Limits”.

DC ELECTRICAL CHARACTERISTICS

Electrical Specifications: Unless otherwise indicated, $T_A = +25^{\circ}C$, $V_{DD} = +1.8V$ to $+5.5V$, $V_{SS} = GND$, $G = +1$ V/V, $V_{IN} = (0.3V)/G$, $R_L = 100$ k Ω to $V_{DD}/2$, $GSEL = V_{DD}/2$, and CS is tied low.						
Parameters	Sym	Min	Typ	Max	Units	Conditions
Amplifier Inputs (V_{IN})						
Input Offset Voltage	V_{OS}	-4.5	± 1.0	+4.5	mV	$G = +1$
		—	± 1.0	—	mV	$G = +10, +50$
Input Offset Voltage Drift	$\Delta V_{OS}/\Delta T_A$	—	± 2	—	$\mu V/^{\circ}C$	$G = +1$, $T_A = -40^{\circ}C$ to $+125^{\circ}C$
Power Supply Rejection Ratio	PSRR	65	80	—	dB	$G = +1$ (Note 1)
Input Bias Current	I_B	—	1	—	pA	
Input Bias Current at Temperature	I_B	—	30	—	pA	$T_A = +85^{\circ}C$
		—	1000	5000	pA	$T_A = +125^{\circ}C$
Input Impedance	Z_{IN}	—	$10^{13} 6$	—	ΩpF	
Amplifier Gain						
Nominal Gains	G	—	1 to 50	—	V/V	+1, +10 or +50
DC Gain Error $G = +1$ $G \geq +10$	g_E	-0.3	—	+0.3	%	$V_{OUT} \approx 0.3V$ to $V_{DD} - 0.3V$
		-1.0	—	+1.0	%	$V_{OUT} \approx 0.3V$ to $V_{DD} - 0.3V$
DC Gain Drift $G = +1$ $G \geq +10$	$\Delta G/\Delta T_A$	—	± 1	—	ppm/ $^{\circ}C$	$T_A = -40^{\circ}C$ to $+125^{\circ}C$
		—	± 4	—	ppm/ $^{\circ}C$	$T_A = -40^{\circ}C$ to $+125^{\circ}C$
Ladder Resistance (Note 1)						
Ladder Resistance	R_{LAD}	200	350	500	k Ω	
Ladder Resistance across Temperature	$\Delta R_{LAD}/\Delta T_A$	—	-1800	—	ppm/ $^{\circ}C$	$T_A = -40^{\circ}C$ to $+125^{\circ}C$
Amplifier Output						
DC Output Non-linearity $G = +1$	V_{ONL}	-0.2	—	+0.2	% of FSR	$V_{OUT} = 0.3V$ to $V_{DD} - 0.3V$, $V_{DD} = 1.8V$
		-0.1	—	+0.1	% of FSR	$V_{OUT} = 0.3V$ to $V_{DD} - 0.3V$, $V_{DD} = 5.5V$
DC Output Non-linearity, $G = +10, +50$	V_{ONL}	-0.05	—	+0.05	% of FSR	$V_{OUT} = 0.3V$ to $V_{DD} - 0.3V$
Maximum Output Voltage Swing	V_{OH}, V_{OL}	$V_{SS}+10$	—	$V_{DD}-10$	mV	$G = +1$; 0.3V output overdrive
		$V_{SS}+10$	—	$V_{DD}-10$	mV	$G \geq +10$; 0.5V output overdrive
Short Circuit Current	I_{SC}	—	± 7	—	mA	$V_{DD} = 1.8V$
		—	± 20	—	mA	$V_{DD} = 5.5V$

Note 1: R_{LAD} (R_F+R_G in Figure 4-1) connects V_{SS} , V_{OUT} , and the inverting input of the internal amplifier. Thus, V_{SS} is coupled to the internal amplifier and the PSRR spec describes PSRR+ only. It is recommended that the V_{SS} pin be tied directly to ground to avoid noise problems.

2: I_Q includes current in R_{LAD} (typically 0.6 μA at $V_{OUT} = 0.3V$), and excludes digital switching currents.

MCP6G01/1R/1U/2/3/4

DC ELECTRICAL CHARACTERISTICS (CONTINUED)

Electrical Specifications: Unless otherwise indicated, $T_A = +25^\circ\text{C}$, $V_{DD} = +1.8\text{V}$ to $+5.5\text{V}$, $V_{SS} = \text{GND}$, $G = +1 \text{ V/V}$, $V_{IN} = (0.3\text{V})/G$, $R_L = 100 \text{ k}\Omega$ to $V_{DD}/2$, $GSEL = V_{DD}/2$, and CS is tied low.

Parameters	Sym	Min	Typ	Max	Units	Conditions
Power Supply						
Supply Voltage	V_{DD}	1.8	—	5.5	V	
Quiescent Current per Amplifier	I_Q	60	110	170	μA	$I_O = 0$ (Note 2)

Note 1: R_{LAD} ($R_F + R_G$ in Figure 4-1) connects V_{SS} , V_{OUT} , and the inverting input of the internal amplifier. Thus, V_{SS} is coupled to the internal amplifier and the PSRR spec describes PSRR+ only. It is recommended that the V_{SS} pin be tied directly to ground to avoid noise problems.

2: I_Q includes current in R_{LAD} (typically $0.6 \mu\text{A}$ at $V_{OUT} = 0.3\text{V}$), and excludes digital switching currents.

AC ELECTRICAL CHARACTERISTICS

Electrical Specifications: Unless otherwise indicated, $T_A = +25^\circ\text{C}$, $V_{DD} = +1.8\text{V}$ to $+5.5\text{V}$, $V_{SS} = \text{GND}$, $G = +1 \text{ V/V}$, $V_{IN} = (0.3\text{V})/G$, $R_L = 100 \text{ k}\Omega$ to $V_{DD}/2$, $C_L = 60 \text{ pF}$, $GSEL = V_{DD}/2$, and CS is tied low.

Parameters	Sym	Min	Typ	Max	Units	Conditions
Frequency Response						
-3dB Bandwidth	BW	—	900	—	kHz	$G = +1$, $V_{OUT} < 100 \text{ mV}_{P-P}$ (Note 1)
	BW	—	350	—	kHz	$G = +10$, $V_{OUT} < 100 \text{ mV}_{P-P}$ (Note 1)
	BW	—	250	—	kHz	$G = +50$, $V_{OUT} < 100 \text{ mV}_{P-P}$ (Note 1)
Gain Peaking	GPK	—	0.3	—	dB	$G = +1$; $V_{OUT} < 100 \text{ mV}_{P-P}$
	GPK	—	0	—	dB	$G = +10$, $V_{OUT} < 100 \text{ mV}_{P-P}$
	GPK	—	0.7	—	dB	$G = +50$; $V_{OUT} < 100 \text{ mV}_{P-P}$
Total Harmonic Distortion plus Noise						
$f = 1 \text{ kHz}$, $G = +1 \text{ V/V}$	THD+N	—	0.0029	—	%	$V_{OUT} = 1.75\text{V} \pm 1.4\text{V}_{PK}$, $V_{DD} = 5.0\text{V}$, $BW = 80 \text{ kHz}$
$f = 1 \text{ kHz}$, $G = +10 \text{ V/V}$	THD+N	—	0.18	—	%	$V_{OUT} = 2.5\text{V} \pm 1.4\text{V}_{PK}$, $V_{DD} = 5.0\text{V}$, $BW = 80 \text{ kHz}$
$f = 1 \text{ kHz}$, $G = +50 \text{ V/V}$	THD+N	—	1.3	—	%	$V_{OUT} = 2.5\text{V} \pm 1.4\text{V}_{PK}$, $V_{DD} = 5.0\text{V}$, $BW = 80 \text{ kHz}$
Step Response						
Slew Rate	SR	—	0.50	—	$\text{V}/\mu\text{s}$	$G = 1$
	SR	—	2.3	—	$\text{V}/\mu\text{s}$	$G = 10$
	SR	—	4.5	—	$\text{V}/\mu\text{s}$	$G = 50$
Noise						
Input Noise Voltage	E_{ni}	—	9	—	μV_{P-P}	$f = 0.1 \text{ Hz}$ to 10 Hz (Note 2)
	E_{ni}	—	50	—	μV_{P-P}	$f = 0.1 \text{ Hz}$ to 30 kHz (Note 2)
Input Noise Voltage Density	e_{ni}	—	38	—	$\text{nV}/\sqrt{\text{Hz}}$	$G = +1 \text{ V/V}$, $f = 10 \text{ kHz}$ (Note 2)
	e_{ni}	—	46	—	$\text{nV}/\sqrt{\text{Hz}}$	$G = +10 \text{ V/V}$, $f = 10 \text{ kHz}$ (Note 2)
	e_{ni}	—	41	—	$\text{nV}/\sqrt{\text{Hz}}$	$G = +50 \text{ V/V}$, $f = 10 \text{ kHz}$ (Note 2)
Input Noise Current Density	i_{ni}	—	4	—	$\text{fA}/\sqrt{\text{Hz}}$	$f = 10 \text{ kHz}$

Note 1: See Table 4-1 for a list of typical numbers and Figure 2-31 for the frequency response versus gain.

2: E_{ni} and e_{ni} include ladder resistance thermal noise.

MCP6G01/1R/1U/2/3/4

DIGITAL ELECTRICAL CHARACTERISTICS

Electrical Specifications: Unless otherwise indicated, $T_A = 25^\circ\text{C}$, $V_{DD} = +1.8\text{V to } +5.5\text{V}$, $V_{SS} = \text{GND}$, $G = +1 \text{ V/V}$, $V_{IN} = (0.3\text{V})/G$, $R_L = 100 \text{ k}\Omega$ to $V_{DD}/2$, $C_L = 60 \text{ pF}$, $\text{GSEL} = V_{DD}/2$, and $\overline{\text{CS}}$ is tied low.

Parameters	Sym	Min	Typ	Max	Units	Conditions
CS Low Specifications						
$\overline{\text{CS}}$ Logic Threshold, Low	V_{CSL}	0	—	$0.2V_{DD}$	V	$\overline{\text{CS}} = 0\text{V}$
$\overline{\text{CS}}$ Input Current, Low	I_{CSL}	—	30	—	μA	$\overline{\text{CS}} = 0\text{V}$
CS High Specifications						
$\overline{\text{CS}}$ Logic Threshold, High	V_{CSH}	$0.8V_{DD}$	—	V_{DD}	V	$\overline{\text{CS}} = V_{DD}$
$\overline{\text{CS}}$ Input Current, High	I_{CSH}	—	0.8	—	μA	$\overline{\text{CS}} = V_{DD} = 5.5\text{V}$
Quiescent Current per Amplifier, Shutdown Mode (I_{DD})	I_{DD_SHDN}	—	120	—	μA	$\overline{\text{CS}} = V_{DD}$, MCP6G03
Quiescent Current per Amplifier, Shutdown Mode (I_{SS}) (Note 3)	I_{SS_SHDN}	—	-2.4	—	μA	$\overline{\text{CS}} = V_{DD} = 1.8\text{V}$, MCP6G03
	I_{SS_SHDN}	—	-7.2	—	μA	$\overline{\text{CS}} = V_{DD} = 5.5\text{V}$, MCP6G03
CS Dynamic Specifications						
Input Capacitance	C_{CS}	—	10	—	pF	
Input Rise/Fall Times	t_{CSRf}	—	—	2	μs	(Note 2)
$\overline{\text{CS}}$ Low to Amplifier Output High Turn-on Time	t_{CSon}	—	40	—	μs	$G = +1 \text{ V/V}$, $V_{DD} = 1.8\text{V}$, $V_{IN} = 0.9V_{DD}$ $\overline{\text{CS}} = 0.2V_{DD}$ to $V_{OUT} = 0.8V_{DD}$
	t_{CSon}	—	7	—	μs	$G = +1 \text{ V/V}$, $V_{DD} = 5.5\text{V}$, $V_{IN} = 0.9V_{DD}$ $\overline{\text{CS}} = 0.2V_{DD}$ to $V_{OUT} = 0.8V_{DD}$
$\overline{\text{CS}}$ High to Amplifier Output High-Z Turn-off Time	t_{CSoff}	—	30	—	μs	$G = +1 \text{ V/V}$, $V_{IN} = V_{DD}/2$, $\overline{\text{CS}} = 0.8V_{DD}$ to $V_{OUT} = 0.1V_{DD}/2$
Hysteresis	V_{CSHY}	—	0.40	—	V	$V_{DD} = 1.8\text{V}$
	V_{CSHY}	—	0.55	—	V	$V_{DD} = 5.5\text{V}$
GSEL Specifications (Note 1)						
GSEL Logic Threshold, Low	V_{GSL}	$0.15V_{DD}$	—	$0.35V_{DD}$	V	Gain changes between 1 and 10, $I_{GSEL} = 0$
GSEL Logic Threshold, High	V_{GSH}	$0.65V_{DD}$	—	$0.85V_{DD}$	V	Gain changes between 1 and 50, $I_{GSEL} = 0$
GSEL Input Current, Low	I_{GSL}	-10	—	-1.5	μA	GSEL voltage = $0.3V_{DD}$
GSEL Input Current, High	I_{GSH}	+1.5	—	+10	μA	GSEL voltage = $0.7V_{DD}$
GSEL Dynamic Specifications (Note 1)						
Input Capacitance	C_{GSEL}	—	8	—	pF	
Input Rise/Fall Times	t_{GSRf}	—	—	10	μs	(Note 2)
Hysteresis	V_{GSHY}	—	45	—	mV	$V_{DD} = 1.8\text{V}$
	V_{GSHY}	—	95	—	mV	$V_{DD} = 5.5\text{V}$
GSEL Low to Valid Output Time, $G = +1$ to $+10$ Select	t_{GSL1}	—	10	—	μs	$V_{IN} = 150 \text{ mV}$, $GSEL = 0.25V_{DD}$ to $V_{OUT} = 1.37\text{V}$
GSEL Middle to Valid Output Time, $G = +10$ to $+1$ Select	t_{GSM10}	—	12	—	μs	$V_{IN} = 150 \text{ mV}$, $GSEL = 0.25V_{DD}$ to $V_{OUT} = 0.28\text{V}$
GSEL High to Valid Output Time, $G = +1$ to $+50$ Select	t_{GSH1}	—	9	—	μs	$V_{IN} = 30 \text{ mV}$, $GSEL = 0.75V_{DD}$ to $V_{OUT} = 1.35\text{V}$
GSEL Middle to Valid Output Time, $G = +50$ to $+1$ Select	t_{GSM50}	—	8	—	μs	$V_{IN} = 30 \text{ mV}$, $GSEL = 0.75V_{DD}$ to $V_{OUT} = 0.18\text{V}$

- Note 1:** GSEL is a tri-level input pin. The gain is 10 when its voltage is low, 1 when it is at mid-supply, and 50 when it is high.
Note 2: Not tested in production. Set by design and characterization.
Note 3: I_{SS_SHDN} includes the current through the $\overline{\text{CS}}$ pin, R_L and R_{LAD} , and excludes digital switching currents. The block diagram on the front page shows these current paths (through V_{SS}).

DIGITAL ELECTRICAL CHARACTERISTICS (CONTINUED)

Electrical Specifications: Unless otherwise indicated, $T_A = 25^\circ\text{C}$, $V_{DD} = +1.8\text{V to } +5.5\text{V}$, $V_{SS} = \text{GND}$, $G = +1 \text{ V/V}$, $V_{IN} = (0.3\text{V})/G$, $R_L = 100 \text{ k}\Omega$ to $V_{DD}/2$, $C_L = 60 \text{ pF}$, $\text{GSEL} = V_{DD}/2$, and $\overline{\text{CS}}$ is tied low.

Parameters	Sym	Min	Typ	Max	Units	Conditions
GSEL High to Valid Output Time, $G = +10$ to $+50$ Select	$t_{\text{GSH}10}$	—	12	—	μs	$V_{IN} = 30 \text{ mV}$, $\text{GSEL} = 0.75V_{DD}$ to $V_{OUT} = 1.38\text{V}$
GSEL Low to Valid Output Time, $G = +50$ to $+10$ Select	$t_{\text{GSL}50}$	—	9	—	μs	$V_{IN} = 30 \text{ mV}$, $\text{GSEL} = 0.25V_{DD}$ to $V_{OUT} = 0.42\text{V}$

- Note 1:** GSEL is a tri-level input pin. The gain is 10 when its voltage is low, 1 when it is at mid-supply, and 50 when it is high.
Note 2: Not tested in production. Set by design and characterization.
Note 3: I_{SS_SHDN} includes the current through the $\overline{\text{CS}}$ pin, R_L and R_{LAD} , and excludes digital switching currents. The block diagram on the from page shows these current paths (through V_{SS}).

TEMPERATURE CHARACTERISTICS

Electrical Specifications: Unless otherwise indicated, $V_{DD} = +1.8\text{V to } +5.5\text{V}$, and $V_{SS} = \text{GND}$.

Parameters	Sym	Min	Typ	Max	Units	Conditions
Temperature Ranges						
Specified Temperature Range	T_A	-40	—	+125	$^\circ\text{C}$	
Operating Temperature Range	T_A	-40	—	+125	$^\circ\text{C}$	(Note 1)
Storage Temperature Range	T_A	-65	—	+150	$^\circ\text{C}$	
Thermal Package Resistances						
Thermal Resistance, 5L-SOT-23	θ_{JA}	—	256	—	$^\circ\text{C/W}$	
Thermal Resistance, 8L-SOIC	θ_{JA}	—	163	—	$^\circ\text{C/W}$	
Thermal Resistance, 8L-MSOP	θ_{JA}	—	206	—	$^\circ\text{C/W}$	
Thermal Resistance, 14L-SOIC	θ_{JA}	—	120	—	$^\circ\text{C/W}$	
Thermal Resistance, 14L-TSSOP	θ_{JA}	—	100	—	$^\circ\text{C/W}$	

- Note 1:** The MCP6G01/1R/1U/2/3/4 family of SGAs operates over this temperature range, but operation must not cause T_J to exceed Maximum Junction Temperature ($+150^\circ\text{C}$).



FIGURE 1-1: Gain Select Timing Diagram.

MCP6G01/1R/1U/2/3/4



FIGURE 1-2: SGA Chip Select Timing Diagram.

1.1 DC Output Voltage Specs / Model

1.1.1 IDEAL MODEL

The ideal SGA output voltage (V_{OUT}) is (see [Figure 1-3](#)):

EQUATION 1-1:

$$V_{O_ID} = GV_{IN}$$

Where:

G is the nominal gain

$$V_{REF} = V_{SS} = 0V$$

This equation holds when there are no gain or offset errors.

1.1.2 LINEAR MODEL

The SGA's linear region of operation is modeled by the line V_{O_LIN} shown in [Figure 1-3](#). V_{O_LIN} includes offset and gain errors, but does not include non-linear effects.

EQUATION 1-2:

$$V_{O_LIN} = G(1 + g_E) \left(V_{IN} - \frac{0.3V}{G} + V_{OS} \right) + 0.3V$$

Where:

G is the nominal gain

g_E is the gain error

V_{OS} is the input offset voltage

$$V_{REF} = V_{SS} = 0V$$

This line's endpoints are 0.3V from the supply rails ($V_{O_ID} = 0.3V$ and $V_{DD} - 0.3V$). The gain error and input offset voltage specifications (in the electrical specifications) relate to [Figure 1-3](#) as follows:

EQUATION 1-3:

$$g_E = 100\% \cdot \frac{V_2 - V_1}{V_{DD} - 0.6V}$$

$$V_{OS} = \frac{V_1}{G(1 + g_E)}, \quad G = +1$$

Where:

$$V_1 = V_{OUT} - V_{O_ID}, \quad V_{O_ID} = 0.3V$$

$$V_2 = V_{OUT} - V_{O_ID}, \quad V_{O_ID} = V_{DD} - 0.3V$$

The input offset specification describes V_{OS} at $G = +1$ V/V.

The DC Gain Drift ($\Delta G/\Delta T_A$) can be calculated from the change in g_E across temperature. This is shown in the following equation:

EQUATION 1-4:

$$\Delta G/\Delta T_A = G \cdot \frac{\Delta g_E}{\Delta T_A}, \quad \text{in units of V/V/}^\circ\text{C}$$

$$\Delta G/\Delta T_A = 100\% \cdot \frac{\Delta g_E}{\Delta T_A}, \quad \text{in units of \%}/^\circ\text{C}$$



FIGURE 1-3: Output Voltage Model.

1.1.3 OUTPUT NON-LINEARITY

[Figure 1-4](#) shows the Integral Non-Linearity (INL) of the output voltage. INL is the output non-linearity error not explained by V_{O_LIN} :

EQUATION 1-5:

$$INL = V_{OUT} - V_{O_LIN}$$

The output non-linearity specification (in the Electrical Specifications, with units of % of FSR) is related to [Figure 1-4](#) by:

EQUATION 1-6:

$$V_{ONL} = 100\% \cdot \frac{\max(V_3, V_4)}{V_{DD} - 0.6V}$$

Where:

$$V_3 = \max(-INL)$$

$$V_4 = \max(INL)$$

Note that the Full Scale Range (FSR) is $V_{DD} - 0.6V$ (0.3V to $V_{DD} - 0.3V$).

MCP6G01/1R/1U/2/3/4

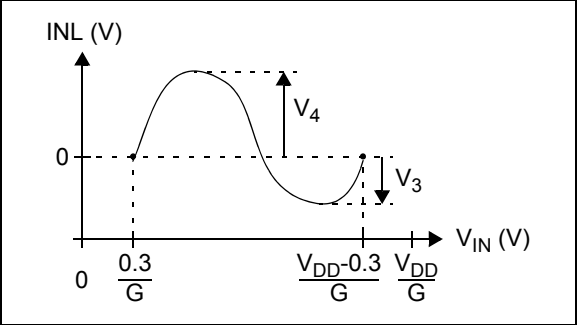

FIGURE 1-4: Output Voltage INL.

2.0 TYPICAL PERFORMANCE CURVES

Note: The graphs and tables provided following this note are a statistical summary based on a limited number of samples and are provided for informational purposes only. The performance characteristics listed herein are not tested or guaranteed. In some graphs or tables, the data presented may be outside the specified operating range (e.g., outside specified power supply range) and therefore outside the warranted range.

Note: Unless otherwise indicated, $T_A = +25^\circ\text{C}$, $V_{DD} = +1.8\text{V to } +5.5\text{V}$, $V_{SS} = \text{GND}$, $G = +1\text{ V/V}$, $V_{IN} = (0.3\text{V})/G$, $R_L = 100\text{ k}\Omega\text{ to } V_{DD}/2$, $C_L = 60\text{ pF}$, $\text{GSEL} = V_{DD}/2$, and CS is tied low.



FIGURE 2-1: DC Gain Error, G = +1.



FIGURE 2-4: DC Gain Drift, G = +1.



FIGURE 2-2: DC Gain Error, G ≥ +10.



FIGURE 2-5: DC Gain Drift, G ≥ +10.



FIGURE 2-3: Input Offset Voltage.



FIGURE 2-6: Input Offset Voltage Drift.

MCP6G01/1R/1U/2/3/4

Note: Unless otherwise indicated, $T_A = +25^\circ\text{C}$, $V_{DD} = +1.8\text{V}$ to $+5.5\text{V}$, $V_{SS} = \text{GND}$, $G = +1\text{ V/V}$, $V_{IN} = (0.3\text{V})/G$, $R_L = 100\text{ k}\Omega$ to $V_{DD}/2$, $C_L = 60\text{ pF}$, $\text{GSEL} = V_{DD}/2$, and CS is tied low.



FIGURE 2-7: The MCP6G01/1R/1U/2/3/4 family shows no phase reversal under overdrive.



FIGURE 2-10: Crosstalk vs. Frequency, with $G = 50$ (circuit in Figure 4-7).



FIGURE 2-8: PSRR vs. Temperature.



FIGURE 2-11: PSRR vs. Frequency.



FIGURE 2-9: Input Noise Voltage Density vs. Frequency.



FIGURE 2-12: Quiescent Current vs. Supply Voltage.

MCP6G01/1R/1U/2/3/4

Note: Unless otherwise indicated, $T_A = +25^\circ\text{C}$, $V_{DD} = +1.8\text{V}$ to $+5.5\text{V}$, $V_{SS} = \text{GND}$, $G = +1\text{ V/V}$, $V_{IN} = (0.3\text{V})/G$, $R_L = 100\text{ k}\Omega$ to $V_{DD}/2$, $C_L = 60\text{ pF}$, $\text{GSEL} = V_{DD}/2$, and CS is tied low.



FIGURE 2-13: Quiescent Current (I_{SS}) in Shutdown Mode vs. Supply Voltage.

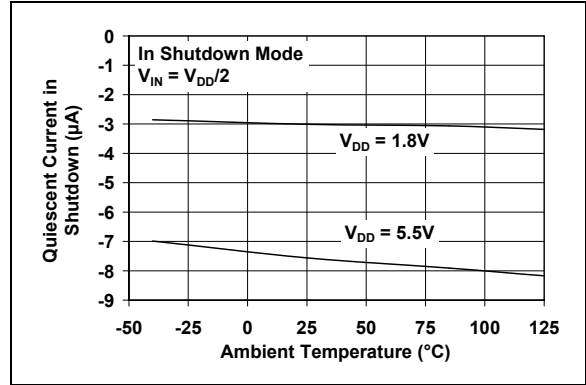

FIGURE 2-16: Quiescent Current (I_{SS}) in Shutdown Mode vs. Temperature.



FIGURE 2-14: Input Bias Current vs. Temperature.



FIGURE 2-17: Input Bias Current vs. Input Voltage.



FIGURE 2-15: Input Bias Current vs. Input Voltage.



FIGURE 2-18: Output Short Circuit Current vs. Supply Voltage.

MCP6G01/1R/1U/2/3/4

Note: Unless otherwise indicated, $T_A = +25^\circ\text{C}$, $V_{DD} = +1.8\text{V}$ to $+5.5\text{V}$, $V_{SS} = \text{GND}$, $G = +1\text{ V/V}$, $V_{IN} = (0.3\text{V})/G$, $R_L = 100\text{ k}\Omega$ to $V_{DD}/2$, $C_L = 60\text{ pF}$, $\text{GSEL} = V_{DD}/2$, and CS is tied low.



FIGURE 2-19: Output Voltage Error vs. Ideal Output Voltage, with $V_{DD} = 1.8\text{V}$.



FIGURE 2-22: Output Voltage Error vs. Ideal Output Voltage, with $V_{DD} = 5.5\text{V}$.



FIGURE 2-20: Output Voltage Headroom vs. Output plus Ladder Current (circuit in Figure 4-4).



FIGURE 2-23: Output Voltage Headroom vs. Temperature.



FIGURE 2-21: Output Impedance vs. Frequency.



FIGURE 2-24: Ladder Resistance Drift.

MCP6G01/1R/1U/2/3/4

Note: Unless otherwise indicated, $T_A = +25^\circ\text{C}$, $V_{DD} = +1.8\text{V}$ to $+5.5\text{V}$, $V_{SS} = \text{GND}$, $G = +1\text{ V/V}$, $V_{IN} = (0.3\text{V})/G$, $R_L = 100\text{ k}\Omega$ to $V_{DD}/2$, $C_L = 60\text{ pF}$, $\text{GSEL} = V_{DD}/2$, and CS is tied low.



FIGURE 2-25: Slew Rate vs. Temperature, with $G = +1$.



FIGURE 2-28: Output Voltage Swing vs. Frequency.



FIGURE 2-26: Slew Rate vs. Temperature, with $G = +10$.



FIGURE 2-29: Slew Rate vs. Temperature, with $G = +50$.



FIGURE 2-27: Bandwidth vs. Resistive Load.



FIGURE 2-30: Bandwidth vs. Capacitive Load.

MCP6G01/1R/1U/2/3/4

Note: Unless otherwise indicated, $T_A = +25^\circ\text{C}$, $V_{DD} = +1.8\text{V}$ to $+5.5\text{V}$, $V_{SS} = \text{GND}$, $G = +1\text{ V/V}$, $V_{IN} = (0.3\text{V})/G$, $R_L = 100\text{ k}\Omega$ to $V_{DD}/2$, $C_L = 60\text{ pF}$, $\text{GSEL} = V_{DD}/2$, and CS is tied low.



FIGURE 2-31: Gain vs. Frequency.



FIGURE 2-34: Gain Peaking vs. Capacitive Load.

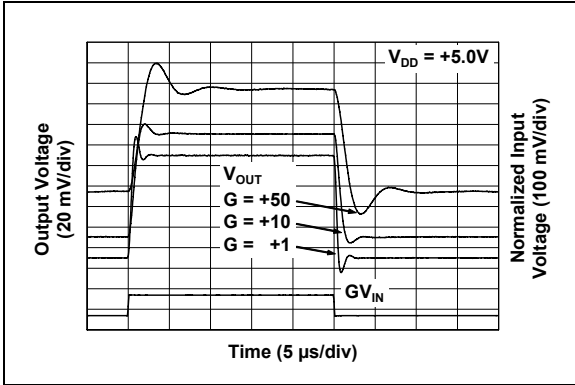

FIGURE 2-32: Small Signal Pulse Response.

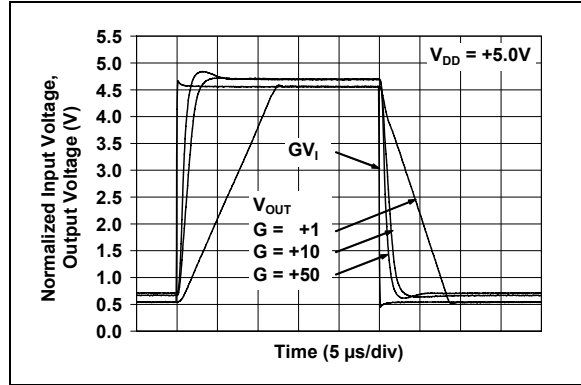

FIGURE 2-35: Large Signal Pulse Response.

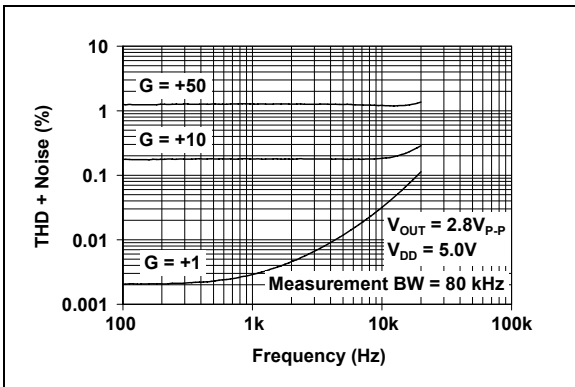

FIGURE 2-33: THD plus Noise vs. Frequency, $V_{OUT} = 2.8\text{ V}_{P-P}$

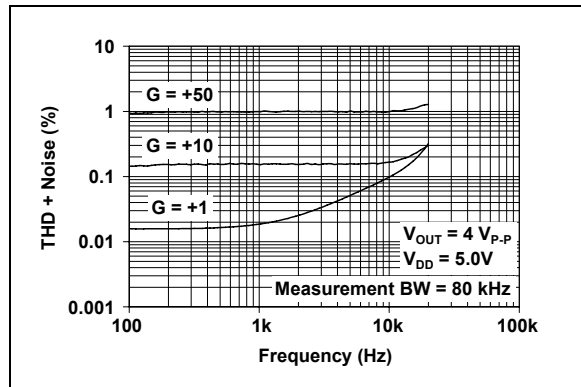

FIGURE 2-36: THD plus Noise vs. Frequency, $V_{OUT} = 4.0\text{ V}_{P-P}$

MCP6G01/1R/1U/2/3/4

Note: Unless otherwise indicated, $T_A = +25^\circ\text{C}$, $V_{DD} = +1.8\text{V}$ to $+5.5\text{V}$, $V_{SS} = \text{GND}$, $G = +1\text{ V/V}$, $V_{IN} = (0.3\text{V})/G$, $R_L = 100\text{ k}\Omega$ to $V_{DD}/2$, $C_L = 60\text{ pF}$, $\text{GSEL} = V_{DD}/2$, and CS is tied low.



FIGURE 2-37: THD plus Noise vs. Supply Voltage.



FIGURE 2-40: THD plus Noise vs. Load Resistance.



FIGURE 2-38: THD plus Noise vs. Output Swing.



FIGURE 2-41: Gain Select Timing, with Gain = 1 and 50.



FIGURE 2-39: Gain Select Timing, with Gain = 1 and 10.



FIGURE 2-42: Gain Select Timing, with Gain = 1 and 10.

MCP6G01/1R/1U/2/3/4

Note: Unless otherwise indicated, $T_A = +25^\circ\text{C}$, $V_{DD} = +1.8\text{V}$ to $+5.5\text{V}$, $V_{SS} = \text{GND}$, $G = +1\text{ V/V}$, $V_{IN} = (0.3\text{V})/G$, $R_L = 100\text{ k}\Omega$ to $V_{DD}/2$, $C_L = 60\text{ pF}$, $\text{GSEL} = V_{DD}/2$, and CS is tied low.



FIGURE 2-43: Output Voltage vs. Chip Select, with $V_{DD} = 1.8\text{V}$.



FIGURE 2-46: Output Voltage vs. Chip Select, with $V_{DD} = 5.0\text{V}$.



FIGURE 2-44: GSEL Pin Current vs. GSEL Voltage, with $V_{DD} = 1.8\text{V}$.



FIGURE 2-47: GSEL Pin Current vs. GSEL Voltage, with $V_{DD} = 5.5\text{V}$.



FIGURE 2-45: GSEL Current, with GSEL Voltage of $0.3V_{DD}$.

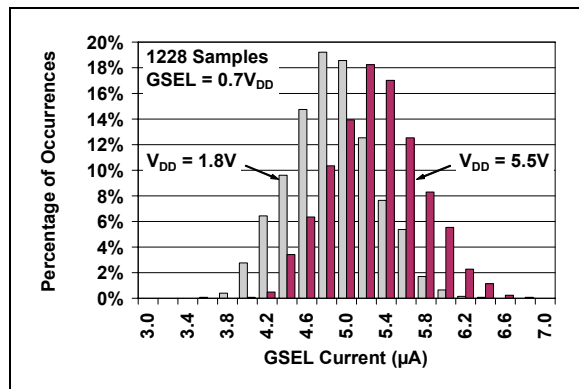

FIGURE 2-48: GSEL Current, with GSEL Voltage of $0.7V_{DD}$.

Note: Unless otherwise indicated, $T_A = +25^\circ\text{C}$, $V_{DD} = +1.8\text{V}$ to $+5.5\text{V}$, $V_{SS} = \text{GND}$, $G = +1\text{ V/V}$, $V_{IN} = (0.3\text{V})/G$, $R_L = 100\text{ k}\Omega$ to $V_{DD}/2$, $C_L = 60\text{ pF}$, $\text{GSEL} = V_{DD}/2$, and CS is tied low.



FIGURE 2-49: GSEL Trip Point between $G = +1$ and $G = +10$.

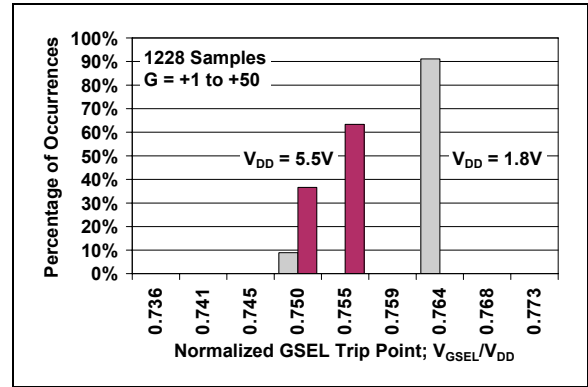

FIGURE 2-50: GSEL Trip Point between $G = +1$ and $G = +50$.

MCP6G01/1R/1U/2/3/4

3.0 PIN DESCRIPTIONS

Descriptions of the pins are listed in [Table 3-1](#) (single op amps) and [Table 3-2](#) (dual and quad op amps).

TABLE 3-1: PIN FUNCTION TABLE FOR SINGLE OP AMPS

MCP6G01 (SOIC, MSOP)	MCP6G01 (SOT-23-5)	MCP6G01R (SOT-23-5)	MCP6G01U (SOT-23-5)	MCP6G03	Symbol	Description
6	1	1	4	6	V_{OUT}	Analog Output
2	4	4	3	2	GSEL	Gain Select Input
3	3	3	1	3	V_{IN}	Analog Input
7	5	2	5	7	V_{DD}	Positive Power Supply
4	2	5	2	4	V_{SS}	Negative Power Supply
—	—	—	—	8	\overline{CS}	Chip Select
1,5,8	—	—	—	1,5	NC	No Internal Connection

TABLE 3-2: PIN FUNCTION TABLE FOR DUAL AND QUAD OP AMPS

MCP6G02	MCP6G04	Symbol	Description
1	1	V_{OUTA}	Analog Output A
2	2	$GSEL_A$	Gain Select Input (SGA A)
3	3	V_{INA}	Analog Input A
8	4	V_{DD}	Positive Power Supply
5	5	V_{INB}	Analog Input B
6	6	$GSEL_B$	Gain Select Input (SGA B)
7	7	V_{OUTB}	Analog Output B
—	8	V_{OUTC}	Analog Output C
—	9	$GSEL_C$	Gain Select Input (SGA C)
—	10	V_{INC}	Analog Input C
4	11	V_{SS}	Negative Power Supply
—	12	V_{IND}	Analog Input D
—	13	$GSEL_D$	Gain Select Input (SGA D)
—	14	V_{OUTD}	Analog Output D

3.1 Analog Output

The output pin (V_{OUT}) is a low impedance voltage source. The selected gain (G) and input voltage (V_{IN}) determine its value.

3.2 Analog Input

The analog inputs (V_{IN}) are high impedance CMOS inputs with low bias currents. Only three fixed, non-inverting gains are available through these inputs.

3.3 Power Supply (V_{SS} and V_{DD})

The Positive Power Supply Pin (V_{DD}) is 1.8V to 5.5V higher than the Negative Power Supply Pin (V_{SS}). For normal operation, the other pins are at voltages between V_{SS} and V_{DD} .

Typically, these parts are used in a single (positive) supply configuration. In this case, V_{SS} is connected to ground, and V_{DD} is connected to the supply. V_{DD} will need a local bypass capacitor (typically 0.01 μ F to 0.1 μ F) within 2 mm of the V_{DD} pin. These parts need to use a bulk capacitor (typically 1.0 μ F to 10 μ F) within 100 mm of the V_{DD} pin; it can be shared with nearby analog parts.

3.4 Digital Inputs

The Chip Select (\overline{CS}) input is a Schmitt-triggered, CMOS logic input.

The Gain Select (GSEL) inputs are tri-level digital inputs. They function similar to normal logic inputs at low (G = +10) and high voltages (G = +50). The pin can also be set to mid-supply (G = +1) by a low impedance source, or by leaving this pin open.

4.0 APPLICATIONS INFORMATION

The MCP6G01/1R/1U/2/3/4 family of Selectable Gain Amplifiers (SGA) is based on simple analog building blocks (see [Figure 4-1](#)). Each of these blocks will be explained in more detail in the following subsections.



FIGURE 4-1: SGA Block Diagram.

4.1 Internal Op Amp

The internal op amp gives the right combination of bandwidth, accuracy, and flexibility.

4.1.1 COMPENSATION CAPACITORS

The internal op amp has three compensation capacitors (comp. caps.) connected to a switching network. They are selected to give good small signal bandwidth at high gains, and good slew rate (full power bandwidth) at low gains. The change in bandwidth as gain changes is between 250 and 900 kHz. Refer to [Table 4-1](#) for more information.

TABLE 4-1: GAIN VS. INTERNAL COMPENSATION CAPACITOR

Gain (V/V)	Internal Comp. Cap.	G x BW (MHz) Typ.	SR (V/μs) Typ.	FPBW (kHz) Typ.	BW (kHz) Typ.
1	Large	0.90	0.50	29	900
10	Medium	3.5	2.3	133	350
50	Small	12.5	4.5	260	250

- Note**
- 1: Changing the compensation capacitor does not change the DC performance (e.g., V_{OS}).
 - 2: G x BW is approximately the Gain Bandwidth Product of the internal op amp.
 - 3: FPBW is the Full Power Bandwidth at $V_{DD} = 5.5V$, which is based on slew rate (SR).
 - 4: BW is the closed-loop, small signal -3 dB bandwidth.

4.1.2 RAIL-TO-RAIL INPUTS

The input stage of the internal op amp uses two differential input stages in parallel; one operates at low V_{IN} (input voltage), while the other operates at high V_{IN} . With this topology, the internal inputs can operate to 0.3V past either supply rail, although the output will clip the signal before that happens.

The inputs need to be kept within a smaller range to prevent output clipping. The input offset voltage also reduces the range; most designs will need the following for normal operation:

EQUATION 4-1:

$$\frac{V_{OL}}{G} + V_{OS} < V_{IN} < \frac{V_{OH}}{G} - V_{OS}$$

The transition between the two input stage occurs when $V_{IN} \approx V_{DD} - 1.1V$ (see [Figure 2-19](#) and [Figure 2-22](#)). For the best distortion and gain linearity, avoid this region of operation.

4.1.3 PHASE REVERSAL

The MCP6G01/1R/1U/2/3/4 amplifier family is designed with CMOS input devices. It is designed to not exhibit phase inversion when the input pins exceed the supply voltages. [Figure 2-7](#) shows an input voltage exceeding both supplies with no resulting phase inversion.

MCP6G01/1R/1U/2/3/4

4.1.4 INPUT VOLTAGE AND CURRENT LIMITS

The ESD protection on the inputs can be depicted as shown in Figure 4-2. This structure was chosen to protect the input transistors, and to minimize input bias current (I_B). The input ESD diodes clamp the inputs when they try to go more than one diode drop below V_{SS} . They also clamp any voltages that go too far above V_{DD} ; their breakdown voltage is high enough to allow normal operation, and low enough to bypass ESD events within the specified limits.

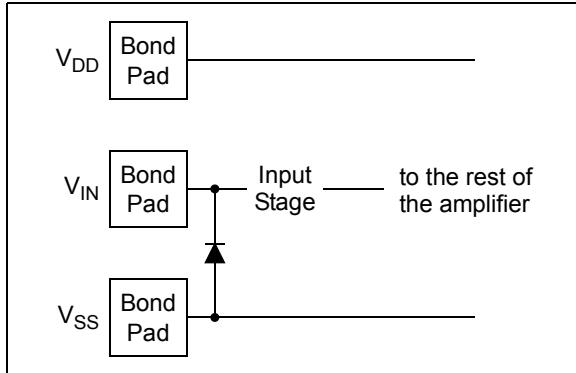

FIGURE 4-2: Simplified Analog Input ESD Structures.

In order to prevent damage and/or improper operation of these amplifiers, the circuits they are in must limit the currents (and voltages) at the V_{IN} pins (see Section “Absolute Maximum Ratings †” at the beginning of Section 1.0 “Electrical Characteristics”). Figure 4-3 shows the recommended approach to protecting these inputs. The internal ESD diodes prevent the input pins (V_{IN}) from going too far below ground, and the resistor R_1 limits the possible current drawn out of the input pin. Diode D_1 prevents the input pin (V_{IN}) from going too far above V_{DD} . When implemented as shown, resistor R_1 also limits the current through D_1 .

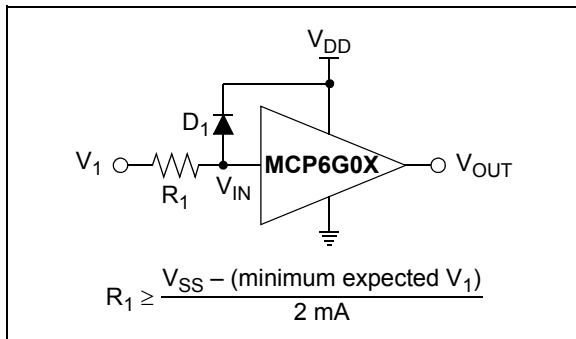

FIGURE 4-3: Protecting the Analog Inputs.

It is also possible to connect the diode to the left of the resistor R_1 . In this case, the current through the diode D_1 needs to be limited by some other mechanism. The resistor then serves as in-rush current limiter; the DC

current into the input pin (V_{IN}) should be very small.

A significant amount of current can flow out of the inputs when the common mode voltage (V_{CM}) is below ground (V_{SS}); see Figure 2-17. Applications that are high impedance may need to limit the useable voltage range.

4.1.5 RAIL-TO-RAIL OUTPUT

The maximum output voltage swing is the maximum swing possible under a particular amplifier load current. The amplifier load current is the sum of the external load current (I_{OUT}) and the current through the ladder resistance (I_{LAD}); see Figure 4-4.

EQUATION 4-2:

$$\text{Amplifier Load Current} = I_{OUT} + I_{LAD}$$

Where:

$$I_{LAD} = \frac{(V_{OUT} - V_{SS})}{R_{LAD}}$$

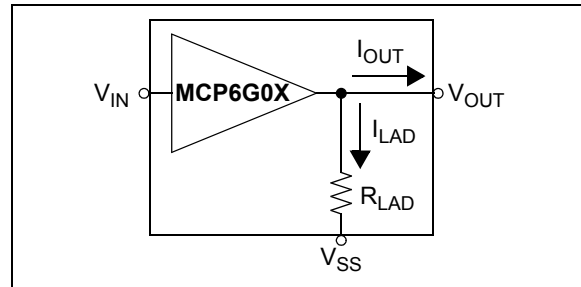

FIGURE 4-4: Amplifier Load Current.

See Figure 2-20 for the typical output headroom ($V_{DD} - V_{OH}$ or $V_{OL} - V_{SS}$) as a function of amplifier load current. The specification table states the output can reach within 10 mV of either supply rail when $R_L = 100 \text{ k}\Omega$.

4.2 Resistor Ladder

The resistor ladder shown in Figure 4-1 ($R_{LAD} = R_F + R_G$) sets the gain. Placing the gain switches in series with the inverting input reduces the parasitic capacitance, distortion, and gain mismatch.

R_{LAD} is an additional load on the output of the SGA and causes additional current draw from the supplies.

When \overline{CS} is high, the SGA is shut down (low power). R_{LAD} is still attached to the V_{OUT} and V_{SS} pins. Thus, these pins and the internal amplifier’s inverting input are all connected through R_{LAD} and the output is not high-Z (unlike the internal op amp).

R_{LAD} contributes to the output noise; see Figure 2-9.

R_{LAD} is intended to be driven at the V_{SS} pin by a low impedance voltage source. The power supply driving the V_{SS} pin should have an output impedance less than 0.1Ω to maintain reasonable gain accuracy.

4.3 MCP6G03 Chip Select (\overline{CS})

The MCP6G03 is a single amplifier with chip select (\overline{CS}). When \overline{CS} is high, the internal op amp is shut down and its output placed in a high-Z state. The resistive ladder is always connected between V_{SS} and V_{OUT} , even in shutdown. This means that the output resistance will be $350\text{ k}\Omega$ (typ.), with a path for output signals to appear at the input. The supply current at V_{SS} includes the current through the load resistor and ladder resistors; it also includes current from the \overline{CS} pin to V_{SS} . When \overline{CS} is low, the amplifier is enabled. If \overline{CS} is left floating, the amplifier may not operate properly.

Figure 1-2 and Figure 2-43 show how the output voltage and supply current response to a \overline{CS} pulse.

4.4 Gain Select (GSEL)

The amplifier can be set to the gains +1 V/V, +10 V/V, and +50 V/V using one input pin (GSEL). At the same time, different compensation capacitors are selected to optimize the bandwidth vs. slew rate trade-off (see Table 4-1). Table 4-2 shows how to change the gain using a GPIO pin on a microcontroller and Table 4-3 shows how to hard wire the gain (i.e., using PCB wiring).

TABLE 4-2: MCU DRIVEN GAIN SELECTION

Gain	MCU Pin's State
+1 V/V	Output PIC's V_{REF} at $V_{DD}/2$
	Digital Output High-Z (Notes 1)
	Output $V_{DD}/2$ PWM signal (Notes 2)
+10 V/V	Digital Output driven Low
+50 V/V	Digital Output driven High

Note 1: See Section 4.8.1 "Driving the Gain Select Pin with a Microcontroller GPIO Pin".

2: See Section 4.8.2 "Driving the Gain Select Pin with a PWM Signal"

TABLE 4-3: HARD WIRED GAIN SELECTION

Selected Gain	Possible GSEL Drivers
+1 V/V	Open Circuit (Note 1)
	Low impedance source at $V_{DD}/2$
+10 V/V	Tied to GND (0V)
+50 V/V	Tied to V_{DD}

Note 1: The GSEL pin floats to mid-supply ($V_{DD}/2$); a bypass capacitor may be needed.

4.5 Capacitive Load and Stability

Large capacitive loads can cause stability problems and reduced bandwidth for the MCP6G01/1R/1U/2/3/4 family of SGAs (Figure 2-30 and Figure 2-34). As the load capacitance increases, there is a corresponding increase in frequency response peaking and step response overshoot and ringing. This happens because a large load capacitance decreases the internal amplifier's phase margin and bandwidth.

When driving large capacitive loads with these SGAs (i.e., $> 60\text{ pF}$), a small series resistor at the output (R_{ISO} in Figure 4-5) improves the internal amplifier's stability by making the load resistive at higher frequencies. The bandwidth will be generally lower than the bandwidth with no capacitive load.



FIGURE 4-5: SGA Circuit for Large Capacitive Loads.

Figure 4-6 gives recommended R_{ISO} values for different capacitive loads. After selecting R_{ISO} for your circuit, double check the resulting frequency response peaking and step response overshoot on the bench. Modify R_{ISO} 's value until the response is reasonable at all gains.

MCP6G01/1R/1U/2/3/4



FIGURE 4-6: Recommended R_{ISO} .

4.6 Layout Considerations

Good PC board layout techniques will help achieve the performance shown in **Section 1.0 “Electrical Characteristics”** and **Section 2.0 “Typical Performance Curves”**. It will also help minimize Electromagnetic Compatibility (EMC) issues.

Because the MCP6G01/1R/1U/2/3/4 SGAs’ frequency response reaches unity gain at 10 MHz when $G = 50$, it is important to use good PCB layout techniques. Any parasitic coupling at high frequency might cause undesired peaking. Filtering high frequency signals (i.e., fast edge rates) can help.

4.6.1 COMPONENT PLACEMENT

Separate different circuit functions: digital from analog, low speed from high speed, and low power from high power. This will reduce crosstalk.

Keep sensitive traces short and straight. Separate them from interfering components and traces. This is especially important for high frequency (low rise time) signals.

4.6.2 SUPPLY BYPASS

Use a local bypass capacitor (0.01 μF to 0.1 μF) within 2 mm of the V_{DD} pin for good, high frequency performance. It must connect directly to ground.

Use a bulk bypass capacitor (i.e., 1.0 μF to 10 μF) within 100 mm of the V_{DD} pin. It needs to connect to ground, and provides large, slow currents. This capacitor may be shared with other nearby analog parts.

Ground plane is important, and power plane(s) can also be of great help. High frequency (e.g., multi-layer ceramic capacitors), surface mount components improve the supply’s performance.

4.6.3 INPUT SOURCE IMPEDANCE

The sources driving the inputs of the SGAs need to have reasonably low source impedance at higher frequencies. **Figure 4-7** shows how the external source resistance (R_S), SGA package pin capacitance (C_{P1}), and SGA package pin-to-pin capacitance (C_{P2}) form a positive feedback voltage divider network. Feedback may cause frequency response peaking and step response overshoot and ringing.



FIGURE 4-7: Positive Feedback Path.

Figure 2-10 shows the crosstalk (referred to input) that results when a hostile signal is connected to the other inputs (e.g., V_{INB} through V_{IND}), and the input of interest (e.g., V_{INA}) has R_S connected to GND. A gain of +50 was chosen for this plot because it demonstrates the worst-case behavior. Increasing R_S increases the crosstalk as expected. At a source impedance of 10 M Ω , there is noticeable change in behavior.

Most designs should use a source resistance (R_S) no larger than 10 M Ω . Careful attention to layout parasitics and proper component selection will help minimize this effect. When a source impedance larger than 10 M Ω must be used, place a capacitor in parallel to C_{P1} to reduce the positive feedback. This capacitor needs to be large enough to overcome gain (or crosstalk) peaking, yet small enough to allow a reasonable signal bandwidth.

4.6.4 SIGNAL COUPLING

The input pins of the MCP6G01/1R/1U/2/3/4 family of SGAs are high impedance. This makes them especially susceptible to capacitively coupled noise. Using a ground plane helps reduce this problem.

When noise is capacitively coupled, the ground plane provides additional shunt capacitance to ground. When noise is magnetically coupled, the ground plane reduces the mutual inductance between traces. Increasing the separation between traces makes a significant difference.

Changing the direction of one of the traces can also reduce magnetic coupling. It may help to locate guard traces next to the victim trace. They should be on both sides of, and as close as possible to, the victim trace. Connect the guard traces to the ground plane at both ends. Also connect long guard traces to the ground plane in the middle.

4.7 Unused Amplifiers

An unused amplifier in a quad package (MCP6G04) should be configured as shown in Figure 4-8. This circuit prevents the output from toggling and causing crosstalk. Because the V_{IN} pin looks like an open circuit, the GSEL voltage is automatically set at $V_{DD}/2$, and the gain is 1 V/V. The output pin provides a buffered $V_{DD}/2$ voltage and minimizes the supply current draw of the unused amplifier.



FIGURE 4-8: Unused Amplifiers.

4.8 Typical Applications

4.8.1 DRIVING THE GAIN SELECT PIN WITH A MICROCONTROLLER GPIO PIN

The circuit in Figure 4-9 uses a microcontroller GPIO pin to drive the Gain Select input (GSEL). Setting the GPIO pin to logic low, high-Z or logic high gives a GSEL voltage of 0V, $V_{DD}/2$ or V_{DD} , respectively ($G = 10, 1$ or 50).



FIGURE 4-9: Driving the GSEL Pin.

The microcontroller's GPIO pin cannot produce a leakage current of more than $\pm 1 \mu\text{A}$ for this circuit to function properly. In noisy environments, a capacitor may need to be added to the GPIO pin.

4.8.2 DRIVING THE GAIN SELECT PIN WITH A PWM SIGNAL

The circuit in Figure 4-10 uses a PWM output on a PIC microcontroller (100 kHz clock rate) to drive the Gain Select input (GSEL). Setting the PWM duty cycle to 0%, 50% or 100% gives a GSEL voltage of 0V, $V_{DD}/2$ or V_{DD} , respectively ($G = 10, 1$ or 50).



FIGURE 4-10: Driving the GSEL Pin.

The PWM clock rate needs to be fast so it is easily filtered and does not interfere with the desired signal, and it needs to be slow enough for good accuracy and low crosstalk. This filter reduces the ripple at the GSEL pin to about 7 mV_{P-P} at $V_{DD} = 5.0\text{V}$. The 10% settling time is about 200 μs ; the filter limits how quickly the gain can be changed. Scale the resistors and/or capacitors for other clock rates, or for different ripple.

4.8.3 GAIN RANGING

Figure 4-11 shows a circuit that measures the current I_x . The circuit's performance benefits from changing the gain on the SGA. Just as a hand-held multimeter uses different measurement ranges to obtain the best results, this circuit makes it easy to set a high gain for small signals and a low gain for large signals. As a result, the required dynamic range at the SGA's output is less than at its input (by up to 34 dB).



FIGURE 4-11: Wide Dynamic Range Current Measurement Circuit.

MCP6G01/1R/1U/2/3/4

4.8.4 SHIFTED GAIN RANGE SGA

Figure 4-12 shows a circuit using a MCP6271 at a gain of +10 in front of a MCP6G01. This shifts the overall gain range to +10 V/V to +500 V/V (from +1 V/V to +50 V/V).

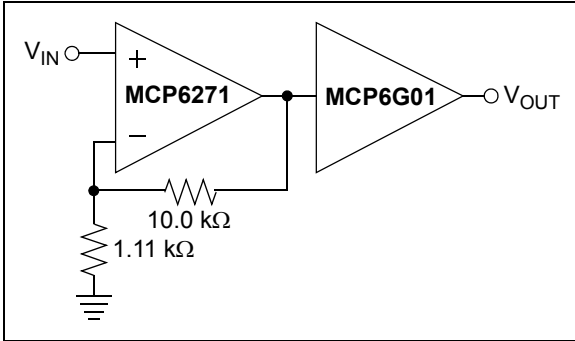

FIGURE 4-12: SGA with Higher Gain Range.

It is also easy to shift the gain range to lower gains (see Figure 4-13). The MCP6001 acts as a unity gain buffer, and the resistive voltage divider shifts the gain range down to +0.1 V/V to +5.0 V/V (from +1 V/V to +50 V/V).

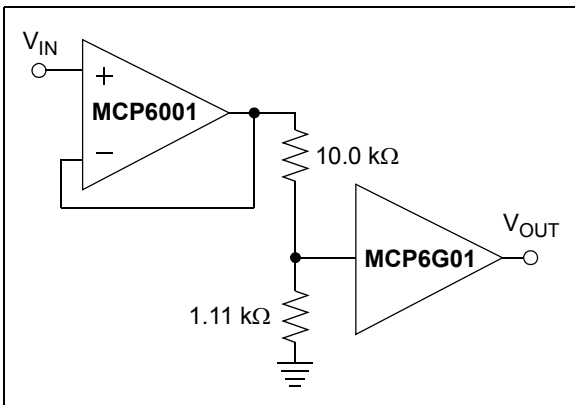

FIGURE 4-13: SGA with Lower Gain Range.

4.8.5 ADC DRIVER

This family of SGAs is well suited for driving Analog-to-Digital Converters (ADC). The gains (1, 10, and 50) effectively increase the ADC's input resolution by a factor of as large as 50 (i.e., by 5.6 bits). This works well for applications needing relative accuracy more than absolute accuracy (e.g., power monitoring); see Figure 4-14.

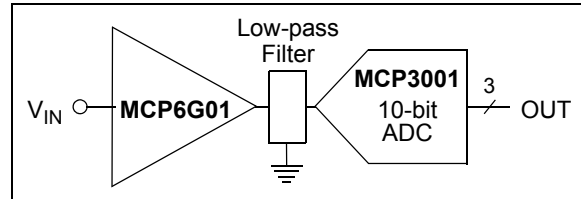

FIGURE 4-14: SGA as an ADC Driver.

The low-pass filter in the block diagram reduces the integrated noise at the MCP6G01's output and serves as an anti-aliasing filter. This filter may be designed using Microchip's FilterLab[®] software, available at www.microchip.com.

5.0 PACKAGING INFORMATION

5.1 Package Marking Information

5-Lead SOT-23 (MCP6G01, MCP6G01R, MCP6G01U)



Device	Code
MCP6G01	CKNN
MCP6G01R	CLNN
MCP6G01U	CMNN

Note: Applies to 5-Lead SOT-23



8-Lead SOIC (150 mil) (MCP6G01, MCP6G02, MCP6G03)

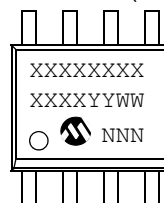

Example:



8-Lead MSOP (MCP6G01, MCP6G02, MCP6G03)

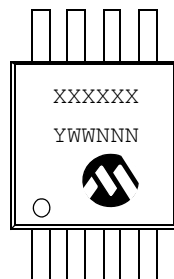

Example:

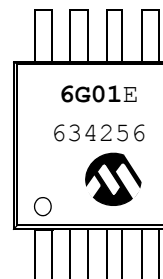

Legend:	XX...X	Customer-specific information
	Y	Year code (last digit of calendar year)
	YY	Year code (last 2 digits of calendar year)
	WW	Week code (week of January 1 is week '01')
	NNN	Alphanumeric traceability code
	(e3)	Pb-free JEDEC designator for Matte Tin (Sn)
	*	This package is Pb-free. The Pb-free JEDEC designator (e3) can be found on the outer packaging for this package.

Note: In the event the full Microchip part number cannot be marked on one line, it will be carried over to the next line, thus limiting the number of available characters for customer-specific information.

MCP6G01/1R/1U/2/3/4

Package Marking Information (Continued)

14-Lead SOIC (150 mil) (MCP6S24)



Example:

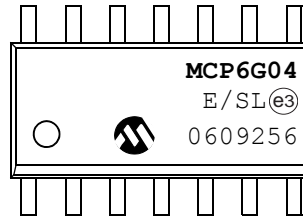

14-Lead TSSOP (4.4mm) (MCP6S24)

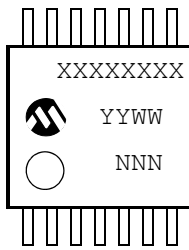

Example:



Legend:	XX...X	Customer-specific information
	Y	Year code (last digit of calendar year)
	YY	Year code (last 2 digits of calendar year)
	WW	Week code (week of January 1 is week '01')
	NNN	Alphanumeric traceability code
	(e3)	Pb-free JEDEC designator for Matte Tin (Sn)
	*	This package is Pb-free. The Pb-free JEDEC designator (e3) can be found on the outer packaging for this package.
Note:	In the event the full Microchip part number cannot be marked on one line, it will be carried over to the next line, thus limiting the number of available characters for customer-specific information.	

MCP6G01/1R/1U/2/3/4

5-Lead Plastic Small Outline Transistor (OT) (SOT-23)

Note: For the most current package drawings, please see the Microchip Packaging Specification located at <http://www.microchip.com/packaging>



Units		INCHES*			MILLIMETERS		
Dimension Limits		MIN	NOM	MAX	MIN	NOM	MAX
Number of Pins	n		5			5	
Pitch	p		.038			0.95	
Outside lead pitch (basic)	p1		.075			1.90	
Overall Height	A	.035	.046	.057	0.90	1.18	1.45
Molded Package Thickness	A2	.035	.043	.051	0.90	1.10	1.30
Standoff	A1	.000	.003	.006	0.00	0.08	0.15
Overall Width	E	.102	.110	.118	2.60	2.80	3.00
Molded Package Width	E1	.059	.064	.069	1.50	1.63	1.75
Overall Length	D	.110	.116	.122	2.80	2.95	3.10
Foot Length	L	.014	.018	.022	0.35	0.45	0.55
Foot Angle	f	0	5	10	0	5	10
Lead Thickness	c	.004	.006	.008	0.09	0.15	0.20
Lead Width	B	.014	.017	.020	0.35	0.43	0.50
Mold Draft Angle Top	a	0	5	10	0	5	10
Mold Draft Angle Bottom	b	0	5	10	0	5	10

* Controlling Parameter

Notes:

Dimensions D and E1 do not include mold flash or protrusions. Mold flash or protrusions shall not exceed .005" (0.127mm) per side.

EIAJ Equivalent: SC-74A

Drawing No. C04-091

Revised 09-12-05

MCP6G01/1R/1U/2/3/4

8-Lead Plastic Micro Small Outline Package (MS) (MSOP)

Note: For the most current package drawings, please see the Microchip Packaging Specification located at <http://www.microchip.com/packaging>



Dimension Limits	Units	MILLIMETERS		
		MIN	NOM	MAX
Number of Pins	N	8		
Pitch	e	0.65 BSC		
Overall Height	A	—	—	1.10
Molded Package Thickness	A2	0.75	0.85	0.95
Standoff	A1	0.00	—	0.15
Overall Width	E	4.90 BSC		
Molded Package Width	E1	3.00 BSC		
Overall Length	D	3.00 BSC		
Foot Length	L	0.40	0.60	0.80
Footprint	L1	0.95 REF		
Foot Angle	φ	0°	—	8°
Lead Thickness	c	0.08	—	0.23
Lead Width	b	0.22	—	0.40

Notes:

- Pin 1 visual index feature may vary, but must be located within the hatched area.
- Dimensions D and E1 do not include mold flash or protrusions. Mold flash or protrusions shall not exceed 0.15 mm per side.
- Dimensioning and tolerancing per ASME Y14.5M
 BSC: Basic Dimension. Theoretically exact value shown without tolerances.
 REF: Reference Dimension, usually without tolerance, for information purposes only.

Microchip Technology Drawing No. C04-111, Sept. 8, 2006

MCP6G01/1R/1U/2/3/4

8-Lead Plastic Small Outline (SN) – Narrow, 150 mil (SOIC)

Note: For the most current package drawings, please see the Microchip Packaging Specification located at <http://www.microchip.com/packaging>



Dimension Limits	Units	INCHES*			MILLIMETERS		
	n	MIN	NOM	MAX	MIN	NOM	MAX
Number of Pins	n		8			8	
Pitch	p		.050			1.27	
Overall Height	A	.053	.061	.069	1.35	1.55	1.75
Molded Package Thickness	A2	.052	.056	.061	1.32	1.42	1.55
Standoff §	A1	.004	.007	.010	0.10	0.18	0.25
Overall Width	E	.228	.237	.244	5.79	6.02	6.20
Molded Package Width	E1	.146	.154	.157	3.71	3.91	3.99
Overall Length	D	.189	.193	.197	4.80	4.90	5.00
Chamfer Distance	h	.010	.015	.020	0.25	0.38	0.51
Foot Length	L	.019	.025	.030	0.48	0.62	0.76
Foot Angle	φ	0	4	8	0	4	8
Lead Thickness	c	.008	.009	.010	0.20	0.23	0.25
Lead Width	B	.013	.017	.020	0.33	0.42	0.51
Mold Draft Angle Top	α	0	12	15	0	12	15
Mold Draft Angle Bottom	β	0	12	15	0	12	15

* Controlling Parameter
 § Significant Characteristic

Notes:
 Dimensions D and E1 do not include mold flash or protrusions. Mold flash or protrusions shall not exceed .010" (0.254mm) per side.
 JEDEC Equivalent: MS-012
 Drawing No. C04-057

MCP6G01/1R/1U/2/3/4

14-Lead Plastic Small Outline (SL) – Narrow, 150 mil (SOIC)

Note: For the most current package drawings, please see the Microchip Packaging Specification located at <http://www.microchip.com/packaging>



Units		INCHES*			MILLIMETERS		
Dimension Limits		MIN	NOM	MAX	MIN	NOM	MAX
Number of Pins	n	14			14		
Pitch	p	.050			1.27		
Overall Height	A	.053	.061	.069	1.35	1.55	1.75
Molded Package Thickness	A2	.052	.056	.061	1.32	1.42	1.55
Standoff §	A1	.004	.007	.010	0.10	0.18	0.25
Overall Width	E	.228	.236	.244	5.79	5.99	6.20
Molded Package Width	E1	.150	.154	.157	3.81	3.90	3.99
Overall Length	D	.337	.342	.347	8.56	8.69	8.81
Chamfer Distance	h	.010	.015	.020	0.25	0.38	0.51
Foot Length	L	.016	.033	.050	0.41	0.84	1.27
Foot Angle	φ	0	4	8	0	4	8
Lead Thickness	c	.008	.009	.010	0.20	0.23	0.25
Lead Width	B	.014	.017	.020	0.36	0.42	0.51
Mold Draft Angle Top	α	0	12	15	0	12	15
Mold Draft Angle Bottom	β	0	12	15	0	12	15

* Controlling Parameter

§ Significant Characteristic

Notes:

Dimensions D and E1 do not include mold flash or protrusions. Mold flash or protrusions shall not exceed .010" (0.254mm) per side.

JEDEC Equivalent: MS-012

Drawing No. C04-065

Revised 7-20-06

MCP6G01/1R/1U/2/3/4

14-Lead Plastic Thin Shrink Small Outline (ST) – 4.4 mm (TSSOP)

Note: For the most current package drawings, please see the Microchip Packaging Specification located at <http://www.microchip.com/packaging>

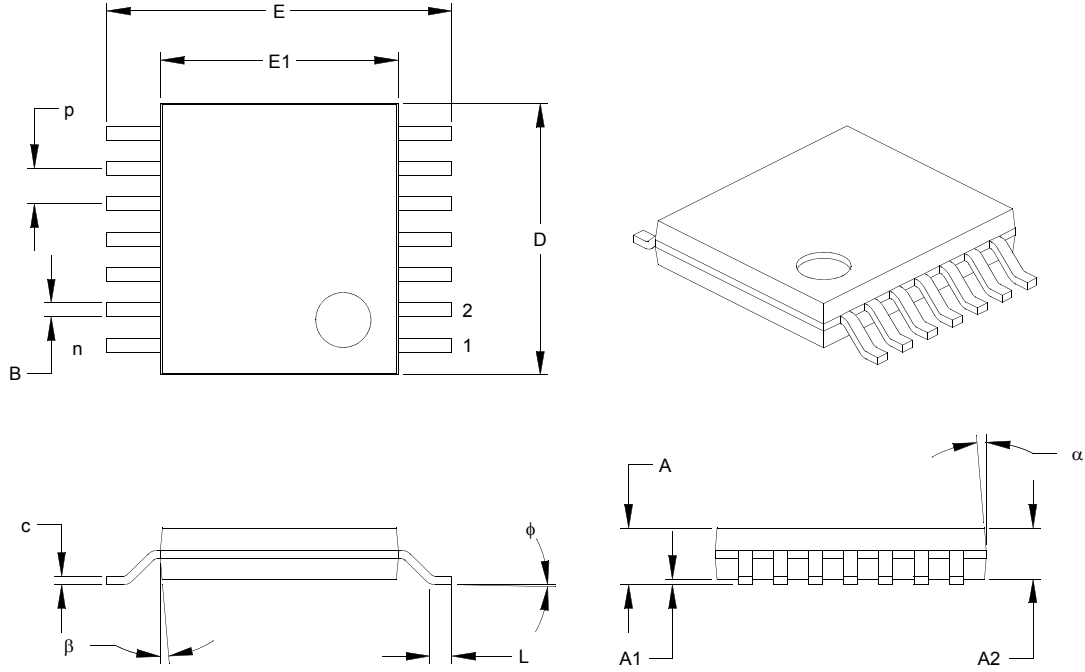

Units		INCHES			MILLIMETERS*		
Dimension Limits		MIN	NOM	MAX	MIN	NOM	MAX
Number of Pins	n	14			14		
Pitch	P	.026 BSC			0.65 BSC		
Overall Height	A	.039	.041	.043	1.00	1.05	1.10
Molded Package Thickness	A2	.033	.035	.037	0.85	0.90	0.95
Standoff	A1	.002	.004	.006	0.05	0.10	0.15
Overall Width	E	.246	.251	.256	6.25	6.38	6.50
Molded Package Width	E1	.169	.173	.177	4.30	4.40	4.50
Molded Package Length	D	.193	.197	.201	4.90	5.00	5.10
Foot Length	L	.020	.024	.028	0.50	0.60	0.70
Foot Angle	φ	0°	4°	8°	0°	4°	8°
Lead Thickness	c	.004	.006	.008	0.09	0.15	0.20
Lead Width	B	.007	.010	.012	0.19	0.25	0.30
Mold Draft Angle Top	α	12° REF			12° REF		
Mold Draft Angle Bottom	β	12° REF			12° REF		

* Controlling Parameter

Notes:

Dimensions D and E1 do not include mold flash or protrusions. Mold flash or protrusions shall not exceed .005" (0.127mm) per side.

BSC: Basic Dimension. Theoretically exact value shown without tolerances.

See ASME Y14.5M

REF: Reference Dimension, usually without tolerance, for information purposes only.

See ASME Y14.5M

JEDEC Equivalent: MO-153 AB-1

Drawing No. C04-087

Revised: 08-17-05

MCP6G01/1R/1U/2/3/4

NOTES:

APPENDIX A: REVISION HISTORY

Revision B (December 2006)

The following is the list of modifications:

- Added SOT-23-5 package option for the single gain blocks MCP6G01, MCP6G01R, and MCP6G01U.
- Added a discussion on V_{IN} range vs. G.

Revision A (September 2006)

- Original Release of this Document.

MCP6G01/1R/1U/2/3/4

NOTES:

MCP6G01/1R/1U/2/3/4

PRODUCT IDENTIFICATION SYSTEM

To order or obtain information, e.g., on pricing or delivery, refer to the factory or the listed sales office.

<u>PART NO.</u>	<u>=X</u>	<u>/XX</u>	
Device	Temperature Range	Package	
Device:	MCP6G01:	Single SGA	
	MCP6G01T:	Single SGA (Tape and Reel for MSOP and SOIC)	
	MCP6G01RT:	Single SGA (Tape and Reel for SOT-23-5)	
	MCP6G01UT:	Single SGA (Tape and Reel for SOT-23-5)	
	MCP6G02:	Dual SGA	
	MCP6G02T:	Dual SGA (Tape and Reel for MSOP and SOIC)	
	MCP6G03:	Single SGA	
	MCP6G03T:	Single SGA (Tape and Reel for MSOP and SOIC)	
	MCP6G04:	Quad SGA	
	MCP6G04T:	Quad SGA (Tape and Reel for SOIC and TSSOP)	
Temperature Range:	E	= -40°C to +125°C	
Package:	MS	= Plastic MSOP, 8-lead	
	OT	= Plastic Small Outline Transistor (SOT-23-5), 5-lead	
	SN	= Plastic SOIC (150 mil Body), 8-lead	
	SL	= Plastic SOIC (150 mil Body), 14-lead (MCP6G04)	
	ST	= Plastic TSSOP (4.4mm Body), 14-lead (MCP6G04)	
			Examples:
			a) MCP6G01-E/MS: Extended Temperature, 8LD MSOP.
			b) MCP6G01T-E/SN: Tape and Reel, Extended Temperature, 8LD SOIC.
			c) MCP6G01T-E/OT: Tape and Reel, Extended Temperature, 5LD SOT-23-5.
			d) MCP6G01RT-E/OT: Tape and Reel, Extended Temperature, 5LD SOT-23-5.
			e) MCP6G01UT-E/OT: Tape and Reel, Extended Temperature, 5LD SOT-23-5.
			a) MCP6G02-E/MS: Extended Temperature, 8LD MSOP.
			b) MCP6G02T-E/SN: Tape and Reel, Extended Temperature, 8LD SOIC.
			a) MCP6G03-E/MS: Extended Temperature, 8LD MSOP.
			b) MCP6G03T-E/SN: Tape and Reel, Extended Temperature, 8LD SOIC.
			c) MCP6G03-E/SN: Extended Temperature, 8LD SOIC.
			a) MCP6G04T-E/SL: Tape and Reel, Extended Temperature, 14LD SOIC.
			b) MCP6G04T-E/ST: Tape and Reel, Extended Temperature, 14LD TSSOP.
			c) MCP6G04-E/ST: Extended Temperature, 14LD TSSOP.

MCP6G01/1R/1U/2/3/4

NOTES:

Note the following details of the code protection feature on Microchip devices:

- Microchip products meet the specification contained in their particular Microchip Data Sheet.
- Microchip believes that its family of products is one of the most secure families of its kind on the market today, when used in the intended manner and under normal conditions.
- There are dishonest and possibly illegal methods used to breach the code protection feature. All of these methods, to our knowledge, require using the Microchip products in a manner outside the operating specifications contained in Microchip's Data Sheets. Most likely, the person doing so is engaged in theft of intellectual property.
- Microchip is willing to work with the customer who is concerned about the integrity of their code.
- Neither Microchip nor any other semiconductor manufacturer can guarantee the security of their code. Code protection does not mean that we are guaranteeing the product as “unbreakable.”

Code protection is constantly evolving. We at Microchip are committed to continuously improving the code protection features of our products. Attempts to break Microchip's code protection feature may be a violation of the Digital Millennium Copyright Act. If such acts allow unauthorized access to your software or other copyrighted work, you may have a right to sue for relief under that Act.

Information contained in this publication regarding device applications and the like is provided only for your convenience and may be superseded by updates. It is your responsibility to ensure that your application meets with your specifications. MICROCHIP MAKES NO REPRESENTATIONS OR WARRANTIES OF ANY KIND WHETHER EXPRESS OR IMPLIED, WRITTEN OR ORAL, STATUTORY OR OTHERWISE, RELATED TO THE INFORMATION, INCLUDING BUT NOT LIMITED TO ITS CONDITION, QUALITY, PERFORMANCE, MERCHANTABILITY OR FITNESS FOR PURPOSE. Microchip disclaims all liability arising from this information and its use. Use of Microchip devices in life support and/or safety applications is entirely at the buyer's risk, and the buyer agrees to defend, indemnify and hold harmless Microchip from any and all damages, claims, suits, or expenses resulting from such use. No licenses are conveyed, implicitly or otherwise, under any Microchip intellectual property rights.

Trademarks

The Microchip name and logo, the Microchip logo, Accuron, dsPIC, KEELOQ, microID, MPLAB, PIC, PICmicro, PICSTART, PRO MATE, PowerSmart, rfPIC, and SmartShunt are registered trademarks of Microchip Technology Incorporated in the U.S.A. and other countries.

AmpLab, FilterLab, Migratable Memory, MXDEV, MXLAB, SEEVAL, SmartSensor and The Embedded Control Solutions Company are registered trademarks of Microchip Technology Incorporated in the U.S.A.

Analog-for-the-Digital Age, Application Maestro, CodeGuard, dsPICDEM, dsPICDEM.net, dsPICworks, ECAN, ECONOMONITOR, FanSense, FlexROM, fuzzyLAB, In-Circuit Serial Programming, ICSP, ICEPIC, Linear Active Thermistor, Mindi, MiWi, MPASM, MPLIB, MPLINK, PICKit, PICDEM, PICDEM.net, PICLAB, PICtail, PowerCal, PowerInfo, PowerMate, PowerTool, REAL ICE, rFLAB, rfPICDEM, Select Mode, Smart Serial, SmartTel, Total Endurance, UNI/O, WiperLock and ZENA are trademarks of Microchip Technology Incorporated in the U.S.A. and other countries.

SQTP is a service mark of Microchip Technology Incorporated in the U.S.A.

All other trademarks mentioned herein are property of their respective companies.

© 2006, Microchip Technology Incorporated, Printed in the U.S.A., All Rights Reserved.

 Printed on recycled paper.

QUALITY MANAGEMENT SYSTEM
CERTIFIED BY DNV
== ISO/TS 16949:2002 ==

Microchip received ISO/TS-16949:2002 certification for its worldwide headquarters, design and wafer fabrication facilities in Chandler and Tempe, Arizona, Gresham, Oregon and Mountain View, California. The Company's quality system processes and procedures are for its PIC® 8-bit MCUs, KEELOQ® code hopping devices, Serial EEPROMs, microperipherals, nonvolatile memory and analog products. In addition, Microchip's quality system for the design and manufacture of development systems is ISO 9001:2000 certified.



MICROCHIP

WORLDWIDE SALES AND SERVICE

AMERICAS

Corporate Office

2355 West Chandler Blvd.
Chandler, AZ 85224-6199
Tel: 480-792-7200
Fax: 480-792-7277
Technical Support:
<http://support.microchip.com>
Web Address:
www.microchip.com

Atlanta

Alpharetta, GA
Tel: 770-640-0034
Fax: 770-640-0307

Boston

Westborough, MA
Tel: 774-760-0087
Fax: 774-760-0088

Chicago

Itasca, IL
Tel: 630-285-0071
Fax: 630-285-0075

Dallas

Addison, TX
Tel: 972-818-7423
Fax: 972-818-2924

Detroit

Farmington Hills, MI
Tel: 248-538-2250
Fax: 248-538-2260

Kokomo

Kokomo, IN
Tel: 765-864-8360
Fax: 765-864-8387

Los Angeles

Mission Viejo, CA
Tel: 949-462-9523
Fax: 949-462-9608

Santa Clara

Santa Clara, CA
Tel: 408-961-6444
Fax: 408-961-6445

Toronto

Mississauga, Ontario,
Canada
Tel: 905-673-0699
Fax: 905-673-6509

ASIA/PACIFIC

Asia Pacific Office

Suites 3707-14, 37th Floor
Tower 6, The Gateway
Harbour City, Kowloon
Hong Kong
Tel: 852-2401-1200
Fax: 852-2401-3431

Australia - Sydney

Tel: 61-2-9868-6733
Fax: 61-2-9868-6755

China - Beijing

Tel: 86-10-8528-2100
Fax: 86-10-8528-2104

China - Chengdu

Tel: 86-28-8665-5511
Fax: 86-28-8665-7889

China - Fuzhou

Tel: 86-591-8750-3506
Fax: 86-591-8750-3521

China - Hong Kong SAR

Tel: 852-2401-1200
Fax: 852-2401-3431

China - Qingdao

Tel: 86-532-8502-7355
Fax: 86-532-8502-7205

China - Shanghai

Tel: 86-21-5407-5533
Fax: 86-21-5407-5066

China - Shenyang

Tel: 86-24-2334-2829
Fax: 86-24-2334-2393

China - Shenzhen

Tel: 86-755-8203-2660
Fax: 86-755-8203-1760

China - Shunde

Tel: 86-757-2839-5507
Fax: 86-757-2839-5571

China - Wuhan

Tel: 86-27-5980-5300
Fax: 86-27-5980-5118

China - Xian

Tel: 86-29-8833-7250
Fax: 86-29-8833-7256

ASIA/PACIFIC

India - Bangalore

Tel: 91-80-4182-8400
Fax: 91-80-4182-8422

India - New Delhi

Tel: 91-11-4160-8631
Fax: 91-11-4160-8632

India - Pune

Tel: 91-20-2566-1512
Fax: 91-20-2566-1513

Japan - Yokohama

Tel: 81-45-471-6166
Fax: 81-45-471-6122

Korea - Gumi

Tel: 82-54-473-4301
Fax: 82-54-473-4302

Korea - Seoul

Tel: 82-2-554-7200
Fax: 82-2-558-5932 or
82-2-558-5934

Malaysia - Penang

Tel: 60-4-646-8870
Fax: 60-4-646-5086

Philippines - Manila

Tel: 63-2-634-9065
Fax: 63-2-634-9069

Singapore

Tel: 65-6334-8870
Fax: 65-6334-8850

Taiwan - Hsin Chu

Tel: 886-3-572-9526
Fax: 886-3-572-6459

Taiwan - Kaohsiung

Tel: 886-7-536-4818
Fax: 886-7-536-4803

Taiwan - Taipei

Tel: 886-2-2500-6610
Fax: 886-2-2508-0102

Thailand - Bangkok

Tel: 66-2-694-1351
Fax: 66-2-694-1350

EUROPE

Austria - Wels

Tel: 43-7242-2244-39
Fax: 43-7242-2244-393

Denmark - Copenhagen

Tel: 45-4450-2828
Fax: 45-4485-2829

France - Paris

Tel: 33-1-69-53-63-20
Fax: 33-1-69-30-90-79

Germany - Munich

Tel: 49-89-627-144-0
Fax: 49-89-627-144-44

Italy - Milan

Tel: 39-0331-742611
Fax: 39-0331-466781

Netherlands - Drunen

Tel: 31-416-690399
Fax: 31-416-690340

Spain - Madrid

Tel: 34-91-708-08-90
Fax: 34-91-708-08-91

UK - Wokingham

Tel: 44-118-921-5869
Fax: 44-118-921-5820

10/19/06



Компания «ЭлектроПласт» предлагает заключение долгосрочных отношений при поставках импортных электронных компонентов на взаимовыгодных условиях!

Наши преимущества:

- Оперативные поставки широкого спектра электронных компонентов отечественного и импортного производства напрямую от производителей и с крупнейших мировых складов;
- Поставка более 17-ти миллионов наименований электронных компонентов;
- Поставка сложных, дефицитных, либо снятых с производства позиций;
- Оперативные сроки поставки под заказ (от 5 рабочих дней);
- Экспресс доставка в любую точку России;
- Техническая поддержка проекта, помощь в подборе аналогов, поставка прототипов;
- Система менеджмента качества сертифицирована по Международному стандарту ISO 9001;
- Лицензия ФСБ на осуществление работ с использованием сведений, составляющих государственную тайну;
- Поставка специализированных компонентов (Xilinx, Altera, Analog Devices, Intersil, Interpoint, Microsemi, Aeroflex, Peregrine, Syfer, Eurofarad, Texas Instrument, Miteq, Cobham, E2V, MA-COM, Hittite, Mini-Circuits, General Dynamics и др.);

Помимо этого, одним из направлений компании «ЭлектроПласт» является направление «Источники питания». Мы предлагаем Вам помощь Конструкторского отдела:

- Подбор оптимального решения, техническое обоснование при выборе компонента;
- Подбор аналогов;
- Консультации по применению компонента;
- Поставка образцов и прототипов;
- Техническая поддержка проекта;
- Защита от снятия компонента с производства.



Как с нами связаться

Телефон: 8 (812) 309 58 32 (многоканальный)

Факс: 8 (812) 320-02-42

Электронная почта: org@eplast1.ru

Адрес: 198099, г. Санкт-Петербург, ул. Калинина, дом 2, корпус 4, литера А.