

## Neutrik® Part Number Guide

### NC3FAH1-0-X

<b>Shell:</b>	<b>B</b>	Black shell, gold contacts	
	<b>BAG</b>	Black shell, silver contacts	
<b>Retention:</b>	<b>w/o</b>	Latch Lock	
	<b>-0</b>	Retention Spring	
<b>Grounding:</b>	<b>0</b>	Separate ground contact connected to shell, male only	
	<b>1</b>	Pin 1 & Panel & Shell connected, no separate ground contact	
	<b>2</b>	Separate ground contact connected to shell & panel, separate Pin 1	
	<b>E</b>	Additional ground contacts	
	<b>w/o number</b>	No ground / Shell contact (except 4 / 5 pole), female only	
<b>Termination:</b>	<b>H</b>	Horizontal PCB mount	
	<b>HL</b>	Lateral left PCB mount	
	<b>HR</b>	Lateral right PCB mount	
	<b>L</b>	Solder Cups	
	<b>V</b>	Vertical PCB mount	
	<b>Y</b>	IDC for wires (no ground)	
	<b>M3</b>	Mounting holes with M3 thread	
	<b>M25</b>	Mounting holes with M2.5 thread	
	<b>-</b>	Not applicable	
	<b>Series:</b>	<b>A, AA, B, BA, D, DL, DLX, MPR, P, X, XX</b>	
	<b>Gender:</b>	<b>F</b>	Female
<b>M</b>		Male	
<b>Number of Contacts:</b>	<b>3, 4, 5, 6, 7, 8, 12</b>		
<b>Connector Type:</b>	<b>A</b>	Adapter	
	<b>AC</b>	PowerCon®	
	<b>B</b>	BNC	
	<b>C</b>	Connector	
	<b>E</b>	RJ45	
	<b>F</b>	RCA / CINCH	
	<b>J (MJ, RJ, SJ)</b>	Jack	
	<b>K</b>	Cable Assemblies	
	<b>L</b>	Loudspeaker	
	<b>M</b>	Modules	
	<b>O</b>	Fiber Connector	
	<b>P</b>	Plugs	
	<b>PP</b>	Patch Panel	
	<b>R</b>	Circular Connector	
<b>T</b>	Transformer		

# XLR Connectors



## Content

## Page

Cable Connectors:		Receptacles:	
XX Series .....	9	A Series .....	15
EMC-XLR Series .....	9	AA Series .....	15
RX Series .....	10	B Series .....	16
XX-HE .....	10	BA Series .....	16
X Series .....	11	A/B Series 5 pole switch .....	17
X-HD Series .....	11	D Series .....	17
XCC Series .....	12	DL Series .....	18
FXS Series .....	12	DLX Series .....	18
FX-SPEC Series .....	12	EMC .....	19
Technical Data .....	13	MPR-HD Series .....	19
Ordering Information .....	14	P Series .....	20
		Combo .....	20
		Accessories .....	21
		Technical Data .....	22
		Ordering Information A/AA Series .....	23
		Ordering Information B/BA Series .....	24
		Ordering Information D/DL/P/Combo Series .....	25
		Panel Cutouts, Assembly Tools .....	26

## Introduction

The XLR connector series is probably together with the Speakon® series Neutrik's most known product range and has due to the simple but striking concept been one of the most important keys to our great success.

We introduced the first XLR version more than 25 years ago, meanwhile it became the worldwide accepted standard.

XLR connectors are widely used in various applications of the professional audio world. Whether as microphone connector, on lighting applications or any kind of sound equipment, the XLR is all over the entertainment industry.

Keyfeatures are:

- Reliable and robust
- Easy to assemble, simple to use
- Excellent cable protection and retention
- Colour coding
- Available in 3 to 7 pole

The reason for the outstanding success of the series is in accompany with these features a constant and peerless quality.

Q u a l i t y   T h i n k i n g

# XLR Cable Connectors



## XX Series



NC3FXX

NC3MXX-B

- The next generation of the worldwide accepted standard
- Unique cage type female contact - increases conductivity
- Female contact with "solder stop" for ease soldering
- Male connector without locking "window" - more stringent housing, increases durability
- Improved chuck type strain relief - increases retention force and makes assembly easier and faster
- New ground contact - excellent contact integrity between chassis and cable connector
- Customized branding using translucent ring
- Sleek and ergonomic design - valuable and handy

### NC\*FXX

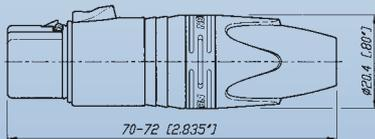

### NC\*MXX

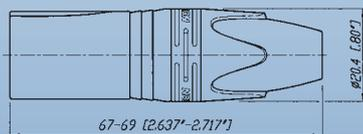

\* ... 3 - 7 contacts



## EMC-XLR Series



NC3FXX-EMC

NC3MXX-EMC

- 3-pole male / female XLR cable connector with integrated capacitive shield to shell connection to avoid RF-interference and LF-noise
- 360° shield contact on female connector ensures best possible shielding and chassis contact
- Patent pending

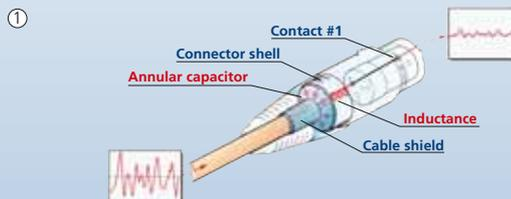

- ① Design guarantees a continuous RF-shield connection but avoids ground loops (no LF-shield connection)
- ② Circular capacitor enables low-inductive shield connection to connector housing
- ③ Cable shield - PIN 1 connection includes EMI suppression bead (blocks high frequencies)

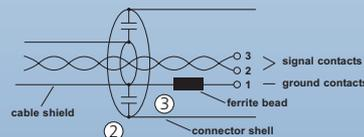

- Quality Design

# XLR Cable Connectors



## RX Series

## XX-HE Series

**NEW**



NC3FRX

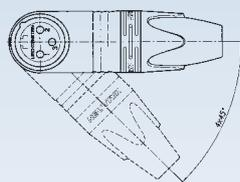

Outlet position

**NEW**



NC3FXX-HE



NC3MXX-HE

- Right angle version of the XX Series - only 20 mm wide
- Extra slim right-angle connector
- Neutrik chuck type strain relief
- 5 selectable cable outlet positions

- Exclusive version of standard XX Series
- Valuable velour chromium plating
- Extra high temperature resistant insulator material
- Machined female contacts

NC\*FRX

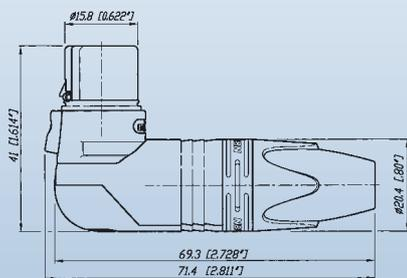

NC\*MRX

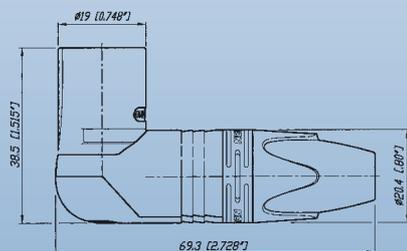

NC3FXX-HE

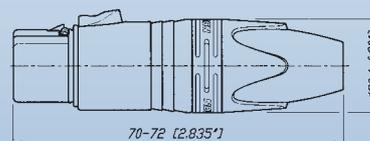

NC3MXX-HE

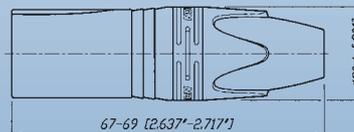

\* ... 3 - 7 contacts

Look for the Logo



# XLR Cable Connectors



## X Series

## X-HD Series



NC3FX



NC3MX



NC5FX-HD



NC4MX-HD

- The worldwide accepted XLR connector standard
- Rugged diecast shell
- Compact design (shortest available XLR cable connector)
- Time saving assembly – 4 parts only, no screws
- Neutrik unique chuck type strain relief
- Gold or silver plated contacts
-  UL Recognized components
- Available in 3 - 7 pin configuration

- "Heavy duty" cable connectors for outdoor use
- All metal design, male stainless steel
- NC\*FX-HD mates with NC\*MPR-HD chassis connector and NC\*MX-HD
- Dust and water protected according IP 65 in mated condition
- Available in 3 - 5 pin configuration

NC\*FX

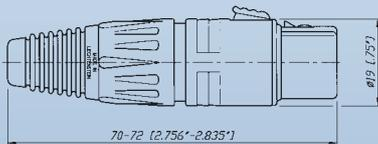

NC\*MX

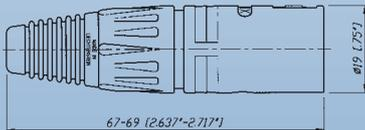

NC\*FX-HD

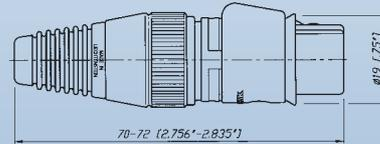

NC\*MX-HD

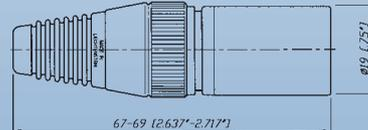

\* ... 3 - 7 contacts

\* ... 3 - 5 contacts

t o i d e n t i f y t h e o r i g i n a l

# XLR Cable Connectors



**XCC Series**



**FXS Series**



**FX-SPEC Series**



NC3FXCC

- 3 pole cable connector with a circumferential shield contact for best EMI protection
- Featuring a coaxial ground spring and coaxial hex crimp ferrule at the cable entrance for proper and reliable transition of the cable shield to the shell
- Zebra coding ring to indicate digital AES signals included

**NC3FXCC**

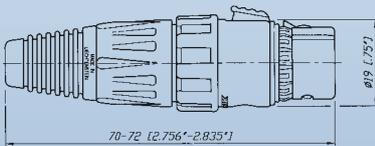

**NC3MXCC**

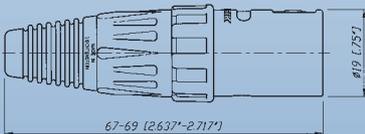

NC3FXS

- FX connector with noiseless ON-OFF switch short-circuiting contacts 2 + 3
- For use on a microphone without switch

**NC3FXS**

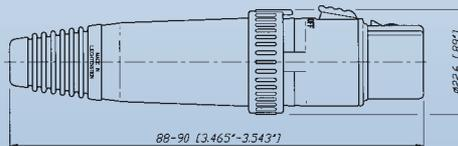

NC3FX-SPEC

- Solid female cable connector with locking ring for highest security of connection
- Uninterrupted EMI protection
- Protect against accidental disconnects
- Thief-proof, grub screw secure connector onto microphone or gooseneck
- Avoids movements and noises

**NC3FX-SPEC**

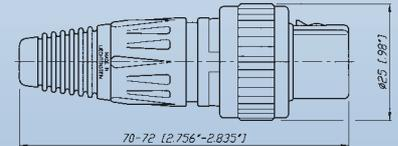

**Quality Thinking**

# Technical Data

Specification		XX Series	EMC Series	X Series	XCC Series	X-HD Series	FXS Series	XX-HE Series	FX-SPEC Series	RX Series
<b>Electrical</b>										
Number of contacts		3 - 7	3	3 - 7	3	3 - 5	3	3	3	3 - 7
Contact resistance	≤ 3 mΩ	●	●	●	●	●	●	●	●	●
Insulation resistance	- initial: > 2 GΩ	●	●	●	●	●	●	●	●	●
	- after damp heat test: > 1 GΩ	●	●	●	●	●	●	●	●	●
Dielectric strength	1500 V dc	●	●	●	●	●	●	●	●	●
Cable shield-shell connection	choosable	●	-	●	-	●	-	●	●	●
	determined	-	capacitive	-	crimp	-	-	-	-	-
Shielding effectiveness	> 55 dB @ 1.3 GHz	-	●	-	●	-	-	-	-	-
Lossy ferrite bead on PIN 1		-	●	-	-	-	-	-	-	-
Rated current per contact @ 35°C										
	3 pole: 16 A	●	5 A	●	●	●	●	●	●	●
	4 pole: 10 A	●	-	●	-	●	-	-	-	●
	5, 6 pole: 7.5 A	●	-	●	-	●	-	-	-	●
	7 pole: 5 A	●	-	●	-	-	-	-	-	●
Capacitance between contacts										
	3 pole: ≤ 4 pF	●	●	●	●	●	●	●	●	●
	4, 5, 6 pole: ≤ 7 pF	●	-	●	-	●	-	-	-	●
	7 pole: ≤ 9 pF	●	-	●	-	-	-	-	-	●
Rated Voltage	50 V ac	●	●	●	●	●	●	●	●	●
<b>Mechanical</b>										
Lifetime > 1'000 cycles		●	●	●	●	●	●	●	●	●
Insertion / withdrawal force ≤ 20 N		●	●	●	●	●	●	●	●	●
Cable O.D. range	3.5 - 8.0 mm	●	-	●	5.4 - 6.2 mm	●	●	●	●	●
Max. wire size	3 pole: 2.5 mm <sup>2</sup> / AWG 14	●	AWG 20	●	●	●	●	●	●	●
	4 pole: 1.5 mm <sup>2</sup> / AWG 16	●	-	●	-	●	-	-	-	●
	5, 6, 7 pole: 1.0 mm <sup>2</sup> / AWG 18	●	-	●	-	●	-	-	-	●
Crimp tool:	6.5 mm Hex die (size "E" acc. to IEC 60803)	-	-	-	●	-	-	-	-	-
<b>Material</b>										
Shell	Zinc diecast (ZnAl4Cu1)	●	●	●	●	-	●	●	●	●
	(gal Ni or black Cr)	●	gal Ni	●	●	black Cr	●	●	●	●
	Stainless steel	-	-	-	-	-	-	-	-	-
Insert	Polyamide PA 6.6 30% GR	●	●	●	●	●	●	●	●	●
Contacts	- female 3 pole: Bronze (CuSn8)	●	●	●	●	●	●	●	●	●
	- female 4 - 7 pole & male: Brass (CuZn39Pb3)	●	-	●	●	●	-	●	-	●
Contact surface	Silver gal 2 μm Ag	●	Au	●	●	Au	●	●	●	●
	or Gold gal 0.2 μm Au hard alloy over 2 μm Ni	-	-	-	-	-	-	-	-	-
Latch lock	St3K32 (latch) / Ck 67 (spring)	-	-	●	●	●	●	-	●	-
Strain-relief clamp	Zinc diecast (ZnAl4Cu1)	●	●	-	-	-	-	●	-	●
	POM	●	●	●	●	●	●	●	●	●
Bushing	PA / PU	●	●	●	●	PU	PU	●	●	●
Circumferential ground spring	Bronze (CuSn6), Ni plated	-	●	-	●	-	-	-	-	-
Crimp ferrule	Brass (CuZn39Pb3), Ni plated	-	-	-	●	-	-	-	-	-
Coding ring	Polyamide PA 6 15% GR	-	-	-	●	-	-	-	-	-
Sealing jacket	EPDM	-	-	-	-	●	-	-	-	-
Securing ring	Brass (CuZn39Pb3)	-	-	-	-	-	-	-	●	-
<b>Environmental</b>										
Operating temperature	-30°C to +80°C	●	●	●	●	●	●	●	●	●
Flammability	UL 94 HB	●	●	●	●	●	●	●	●	●
Protection class	IP 40	●	●	●	●	IP 65	●	●	●	●
Solderability complies with IEC 68-2-20		●	●	●	●	●	●	●	●	●
Manufacturing Standard IEC 61076-2-103		●	●	●	●	●	●	●	●	●

- Quality Design



# Ordering Information

## Ordering Information for Cable Connectors

Female	Male	Shell	Contact - plating	3 pole	4 pole	5 pole	6 pole	7 pole
<b>XX Series</b>								
NC*FXX	NC*MXX	Nickel	Silver	●	●	●	●	●
NC*FXX-B	NC*MXX-B	Black Cr	Gold	●	●	●	●	●
NC*FXX-BAG	NC*MXX-BAG	Black Cr	Silver	●	●	●	●	●
NC3FXX-**-D <sup>1</sup>	NC3MXX-**-D <sup>1</sup>	Nickel / Black Cr	Silver / Gold	●	-	-	-	-
<b>XX-EMC Series</b>								
NC3FXX-EMC	NC3MXX-EMC	Nickel	Gold	●	-	-	-	-
NC3FXX-EMC-B	-	Black Cr	Gold	●	-	-	-	-
<b>X Series</b>								
NC*FX	NC*MX	Nickel	Silver	●	●	●	●	●
NC*FX-B	NC*MX-B	Black Cr	Gold	●	●	●	●	●
NC*FX-BAG	NC*MX-BAG	Black Cr	Silver	●	●	●	●	●
NC3FX-**-D <sup>1</sup>	NC3MX-**-D <sup>1</sup>	Nickel / Black Cr	Silver / Gold	●	-	-	-	-
NC6FSX <sup>2</sup>	NC6MSX <sup>2</sup>	Nickel	Silver	-	-	-	●	-
NC6FSX-B <sup>2</sup>	NC6MSX-B <sup>2</sup>	Black Cr	Gold	-	-	-	●	-
NC6FSX-BAG <sup>2</sup>	NC6MSX-BAG <sup>2</sup>	Black Cr	Silver	-	-	-	●	-
<b>RX Series</b>								
NC*FRX	NC*MRX	Nickel	Silver	●	●	●	●	●
NC*FRX-B	NC*MRX-B	Black Cr	Gold	●	●	●	●	●
NC*FRX-BAG	NC*MRX-BAG	Black Cr	Silver	●	●	●	●	●
<b>XX-HE Series</b>								
NC3FXX-HE	NC3MXX-HE	Velour Chromium	Gold	●	-	-	-	-
<b>FXS Series</b>								
NC3FXS	-	Nickel	Gold	●	-	-	-	-
NC3FXS-B	-	Black Cr	Gold	●	-	-	-	-
<b>FX-SPEC Series</b>								
NC3FX-SPEC	-	Black Cr	Silver	●	-	-	-	-
<b>XCC Series</b>								
NC3FXCC	NC3MXCC	Nickel	Gold	●	-	-	-	-
<b>X-HD Series</b>								
NC*FX-HD	NC*MX-HD	Nickel	Gold	●	●	●	-	-
NC3FX-HD-B	NC3MX-HD-B	Metal Black	Gold	●	-	-	-	-

### Accessories and Assembly Tools

Detailed information on page 21 and 26.

\* ..... Number of Contacts

\*\* ..... Nickel or Black

-D<sup>1</sup> ..... Bulk packed, to be ordered in multiples of 100 pcs.

<sup>2</sup> ..... Switchcraft Equivalent

Look for the Logo



# XLR Chassis Connectors

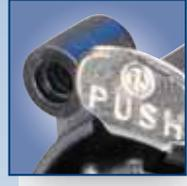

## A Series

## AA Series



NC3FAH1



NC3MAHR



NC3FAAV2



NC3MAAH-1

- Smallest XLR receptacles, highest packing density
- Plastic housing, steel retention lug
- Fork type female contacts
- Polished contact areas and hard gold plating
- Various grounding options

- Front panel cutout and PCB layout 100% compatible to the A Series
- Most cost-effective series
- "Tulip" type female contact design with high contact pressure
- Selective gold plated contact and PCB termination area for best conductivity and solderability
- Plastic housing flammability UL 94 HB

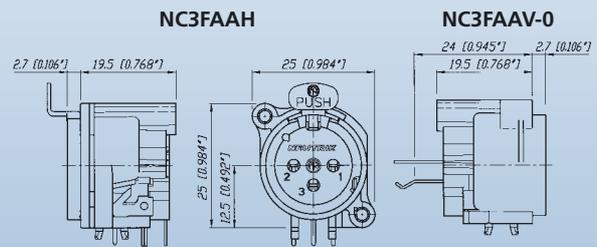
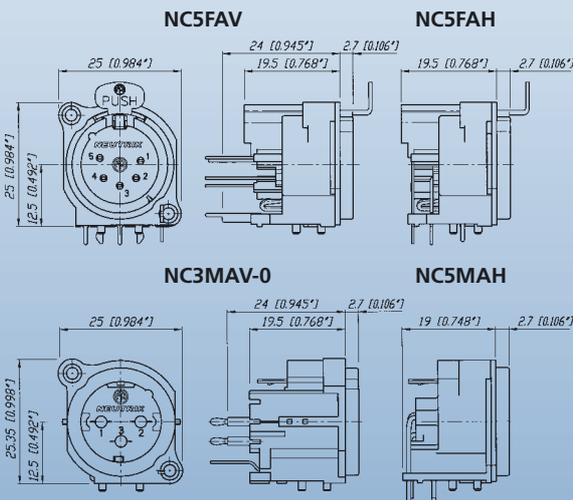

### Grounding Options (A / AA / B / BA Series):

- 1 ... Pin 1 & Panel & Shell connected, no separate ground contact
- 2 ... Separate ground contact connected to shell & panel, separate Pin 1 w/o number: No ground / Shell contact (except 4 / 5 pole)

t o i d e n t i f y t h e o r i g i n a l

# XLR Chassis Connectors



## B Series

## BA Series



NC3FBV



NC3MBV

**NEW**



NC3FBAV2



NC3MBAH

- Same as A Series with exception of a metal mounting flange enabling continuous circumferential ground contact to chassis for best EMC and RF protection
- Fastening with B-screw

- More economical version of B Series with modified metal flange
- Fastening with A-screw
- 3, 4 and 5 pole version

NC3FBY

NC3FBH1

NC3FBAV

NC3FBAH

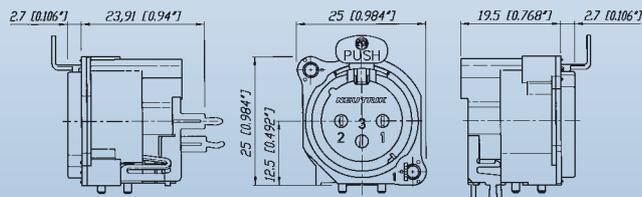
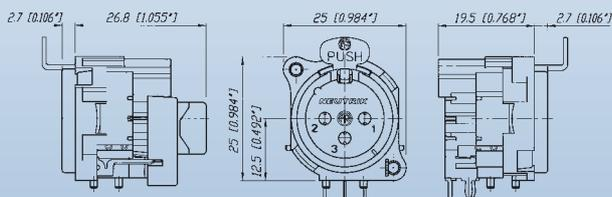

NC3MBH

NC3MBV

NC3MBAV

NC3MBAH

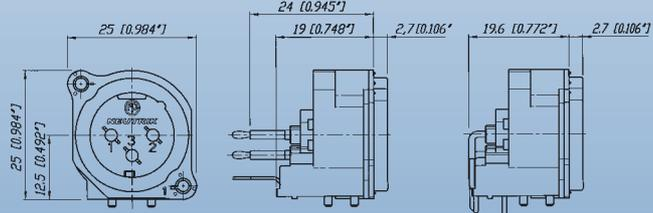
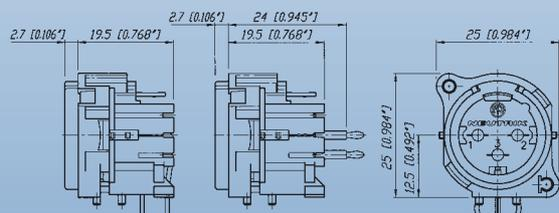

Quality Thinking

# XLR Chassis Connectors



## A/B Series 5-pole switch

## D Series



NC5FAV-SW



NC5MAV-SW



NC3FD-V



NC3MDM3-V

- A and B Series 5 pole connector with additional switch
- Normally open, normally closed (NO - NC) contact
- Switch activated by mating XLR cable connector
- Available in 5 pole, 3 or 4 pole on request

- "D" Shape metal shell
- Optimal RF protection using 3 shield contacts
- Horizontal and vertical PCB mount with separate ground contact
- Mounting holes with M3 threads available
- 2 piece connector, insert is removable from shell
- Front locked / unlocked insert
- Special version with screw termination

Inserting (Schematic):

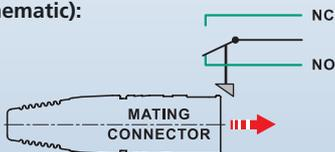

NC5FAV-SW

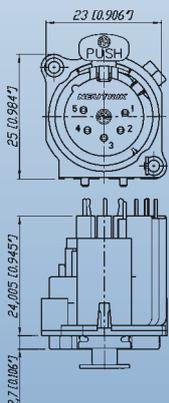

NC5MBV-SW

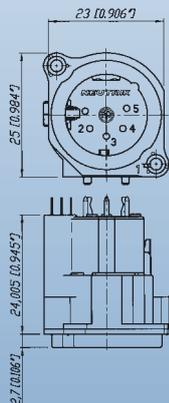

NC3FD-V / NC3FD-H

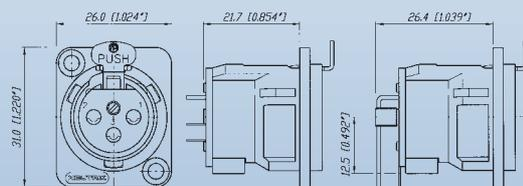

NC3MD-V / NC3MD-H

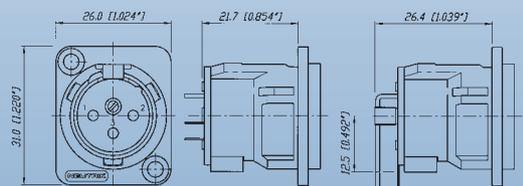

- Quality Design

# XLR Chassis Connectors



## DL Series



NC3FD-L-1



NC4MDM3-H

- Unified "D" metal shell
- Solder cups on 3 - 7 pole version
- Additional PCB mount on 4 and 5 pole
- Front and rear mountable
- High End "-HE" version available with machined female contacts, temperature resistant insulator and valuable velour chromium plating

NC3FD-L-1

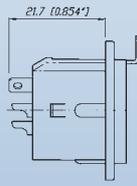
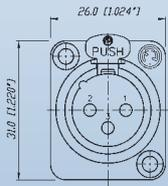

NC\*FDM3-H

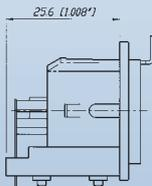

NC3MD-L-1

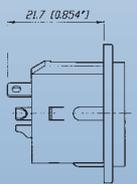
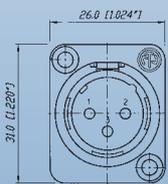

NC\*MDM3-H

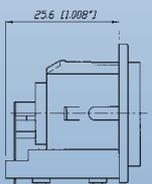

\* ... 3 - 5 contacts

## DLX Series

**NEW**



NC3FD-LX



NC3MD-LX

- Next generation of the popular DL Series with greater functionality
- All metal housing works in combination with a new duplex ground contact yielding the best RF protection and ground conductivity in a chassis mount XLR
- Male connector's retention bar replaces plastic design with all metal version
- Unique cage type female contacts on 3 pole version for increased conductivity
- Machined male and female contacts on four to seven pin versions
- D-style housing provides installation compatibility with industry standard D mounting dimensions

NC3FD-LX

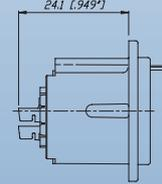
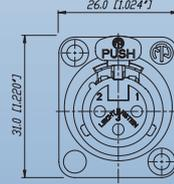

NC\*MD-LX

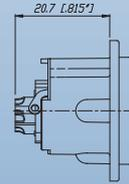

\* ... 3 - 7 contacts

Quality Thinking

# XLR Chassis Connectors



## EMC

## MPR-HD Series

**NEW**



NC3FDX-EMC-SPEC

- 3-pole female XLR chassis connector with integrated capacitive shield to shell connection to avoid RF-interference and LF-noise
- 360° shield contact on female connector ensures best possible shielding and chassis contact
- D flange chassis for panel mount applications
- Includes the locking nut of the NC3FX-SPEC for secure fastening of a gooseneck for instance
- Special flange for large openings available
- Patent pending

Detailed information of RF-shielding see page 9 - EMC cable-connector.

NC3FDX-EMC-SPEC

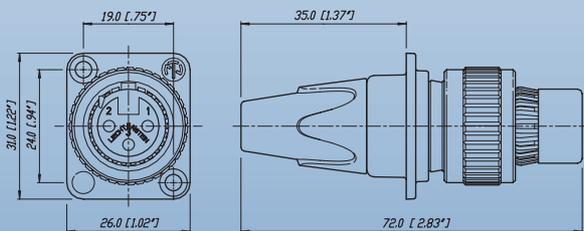

**NEW**



NC3MPR-HD



NC5MPR-HD

- IP 65 - in combination with NC\*FX-HD cable connectors
- Perfect for outdoor applications
- Sealing gasket for water tight panel mount
- Gold plated contacts



NC5FX-HD

NC5MPR-HD

NC3MPR-HD

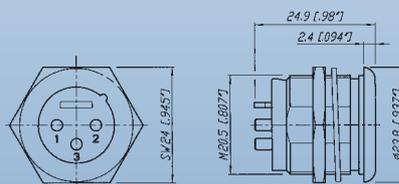

\* ... 3 - 5 contacts

- Quality Design

# XLR Chassis Connectors



## P Series

## Combo Series



NC4FP-1



NC6MP-B



NCJ9FI-V



NCJ10FI-S

- Smallest available hard wiring receptacles with large solder cups
- Short female receptacle
- Compatible with Switchcraft DxM, DxP; Cannon XLRx31, XLRx32
- 6 pole version available with Switchcraft contact arrangement (NC6FSP-1, NC6MSP)

- Combined XLR receptacle and 1/4" phone jack
- Attractive "front end" design
- Saves rack space by combining 2 connectors in one housing
- Horizontal or vertical PCB mounting or hard wire soldering
- Fully normalised
- Stereo or mono version
- Very low conductor capacitance, therefore suitable for digital audio
- Fastening: Self-tapping Plastite® screws with thread 2.9 x 1.06 and tri-rondular configuration (A screw)
- Front dimension: 30 x 27 mm

NC3FP-1

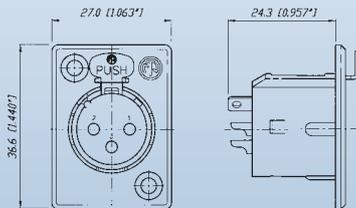

NC3MP

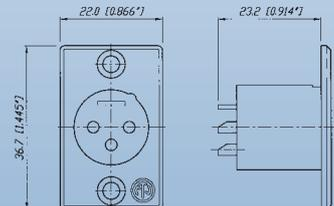

NCJ10FI-H

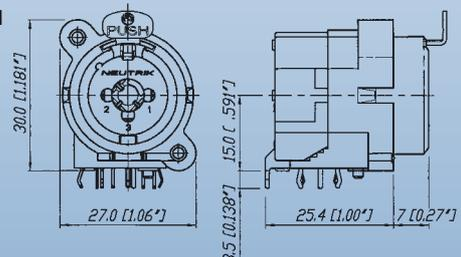

Quality Thinking

# Accessories

## Colour Coded Accessories

Part No.	Description	Black	Brown	Red	Orange	Yellow	Green	Blue	Violet	Grey	White
		0	1	2	3	4	5	6	7	8	9
<b>XLR Cable Connectors</b>											
BSX-*	Coloured bushing for X Series										
BXX-*	Coloured bushing for XX Series										
XCR-*	Coloured coding ring for X Series										
XXR-*	Coloured coding ring for XX Series										
<b>XLR Chassis Connectors</b>											
ACRF-*	Coloured ring for female 4 + 5 pole A Series and 3 pole BA Series										
ACRM-*	Coloured ring for male 4 + 5 pole A Series and 3 pole BA Series										
DSS-*	Lettering plate for D Series										

## Accessories

<b>XLR Cable Connectors</b>				
XXCR	Translucent coding ring for XX Series			Example
XCCR	Coding ring for X Series digital signals			
<b>XLR Chassis Connectors</b>				
DBA	Dummy-plate for D Series panel cut outs			
SCD*	Rubber sealing cover for female and male D Series			SCDF      SCDM
SC*	Rubber sealing cap for female and male XLR receptacles			SCF      SCM
SFAV	Rubber frame for A / B Series to mount between front plate and rear vertical print			SFAV      Example
A-Screw-1-8	Plastite® screw 2.9 x 8**			A Screw      B Screw
B-Screw-1-8	TAPTITE® screw 2.5 x 8*			

\*\* ... Minimum order quantity of 1000 pcs.

- Quality Design



# Technical Data

Specification		A Series	AA Series	B Series	BA Series	D Series	DL/DLX Series	MPR-HD Series	P Series	Combo Series
<b>Electrical</b>										
Number of contacts		3 - 5	3	3 - 5	3	3	3 - 7	3 - 5	3 - 7 (6**)	5 - 10
Contact resistance	≤ 5 mΩ	●	● ≤ 8 mΩ	●	●	●	●	●	●	● ≤ 10 mΩ
Insulation resistance	- initial: > 2 GΩ	●	●	●	●	●	●	●	●	●
	- after damp heat test: > 1 GΩ	●	●	●	●	●	●	●	●	● > 500 MΩ
Dielectric strength	1500 V dc	●	●	●	●	●	●	●	●	●
Rated voltage	50 V ac	●	●	●	●	●	●	●	●	●
Rated current per contact										
	3 pole: 6 A	●	●	●	●	●	16 A	16 A	16 A	-
	4 pole: 6 A	●	-	●	-	-	10 A	10 A	10 A	-
	5, 6 pole: 3 A	●	-	●	-	-	7.5 A	7.5 A	7.5 A	-
	7 pole: 5 A	-	-	-	-	-	●	-	●	-
Combo XLR + Jack contact	7.5 A	-	-	-	-	-	-	-	-	●
Capacitance between contacts										
	3 pole: ≤ 7 pF	●	●	●	●	-	≤ 4 pF	≤ 4 pF	≤ 4 pF	≤ 2 pF
	4, 5, 6 pole: ≤ 7 pF	●	-	●	-	-	●	●	●	-
	7 pole: ≤ 9 pF	-	-	-	-	-	●	-	●	-
<b>Mechanical</b>										
Lifetime > 1'000 mating cycles		●	●	●	●	●	●	●	●	●
Insertion / withdrawal force	≤ 20 N	●	●	●	●	●	●	●	●	● 25 N
Retention method										
	- standard: latch lock	●	●	●	●	●	●	●	●	● (XLR)
	- "0" Version: ≥ 20 N separating force	●	●	●	●	●	●	●	●	● 25 N
<b>Material</b>										
Insert	Polyamide PA 6.6 30% GR	●	●	●	●	●	●	●	●	●
Shell	Zinc diecast ZnAl4Cu1	-	-	-	-	●	●	●	●	-
	(gal Ni or black Cr plated)	-	-	-	-	●	●	Ni plated	●	-
Ring	Zinc diecast ZnAl4Cu1	-	-	●	●	-	-	-	-	-
Contacts	- female 3 pole: Bronze CuSn6	●	●	●	●	●	●	-	●	●
	4 - 5 pole: Bronze CuSn6	●	-	●	-	-	-	-	-	-
	4 - 7 pole: Brass CuZn39Pb3	-	-	-	-	-	●	-	●	-
	- male: Brass CuZn35Pb2	●	●	●	●	●	●	●	●	-
Contact surface	gal 0.2 µm AuCo over 2 µm NiP15 (Tribor®)	●	●	●	●	-	-	-	-	●
	gal 2 µm Ag or gal 0.2 µm Au hard alloy over 2 µm Ni	-	-	-	-	●	●	Au	●	-
Latch lock & spring	Ck 67 steel, treated	●	●	●	●	●	●	-	●	●
<b>Environmental</b>										
Operating temperature	-30°C to +80°C	●	●	●	●	●	●	●	●	●
Protection class	IP 40	●	●	●	●	●	●	IP 65	●	●
Flammability	UL 94 HB	●	●	●	●	●	●	●	●	●
	UL 94 V-0	3 pole	-	3 pole	-	-	-	-	-	-
Solderability complies with IEC 68-2-20		●	●	●	●	●	●	●	●	●
Mounting screw		A	A	1)	A	-	-	-	-	A
Colour coding		ACR-*	-	-	ACR-*	DSS	DSS	-	-	-
	(4 + 5 pole only)									
1) .... B Series 3 pole connectors > B-screw, 4 & 5 pole versions > A-screw										
** .... P Series male 3 - 6 pole										

Quality Thinking

# Ordering Information

## Ordering Information for Receptacles

Female	Male	Shell	Contact	3 pole	4 pole	5 pole	Female	Male	Shell	Contact	3 pole
<b>A Series</b>							<b>AA Series</b>				
NC*FAH-D		Black Plastic	Gold	-	●	●	NC3FAAH	NC3MAAH	Black Plastic	Gold	●
	NC*MAH	Black Plastic	Gold	●	●	●	NC3FAAH-0		Black Plastic	Gold	●
NC*FAH-0		Black Plastic	Gold	●	●	●	NC3FAAH1	NC3MAAH-1	Black Plastic	Gold	●
	NC3MAH-0	Black Plastic	Gold	●	-	-	NC3FAAH1-0		Black Plastic	Gold	●
NC3FAHL-0		Black Plastic	Gold	●	-	-		NC3MAAH-0	Black Plastic	Gold	●
NC3FAHR-0		Black Plastic	Gold	●	-	-	NC3FAAH2		Black Plastic	Gold	●
NC3FAH1-D	NC3MAH-1	Black Plastic	Gold	●	-	-	NC3AAH2-0		Black Plastic	Gold	●
NC3FAH1-0		Black Plastic	Gold	●	-	-	NC3FAAV	NC3MAAV	Black Plastic	Gold	●
NC3FAHL1-D		Black Plastic	Gold	●	-	-	NC3FAAV-0		Black Plastic	Gold	●
	NC3MAHL	Black Plastic	Gold	●	-	-	NC3FAAV1	NC3MAAV-1	Black Plastic	Gold	●
NC3FAHL1-0		Black Plastic	Gold	●	-	-	NC3AAV1-0		Black Plastic	Gold	●
NC3FAHR1-D		Black Plastic	Gold	●	-	-		NC3MAAV-0	Black Plastic	Gold	●
	NC3MAHR	Black Plastic	Gold	●	-	-	NC3FAAV2		Black Plastic	Gold	●
NC3FAHR1-0		Black Plastic	Gold	●	-	-	NC3FAAV2-0		Black Plastic	Gold	●
NC3FAH2-D		Black Plastic	Gold	●	-	-					
NC3FAH2-0		Black Plastic	Gold	●	-	-					
NC3FAHR2-D		Black Plastic	Gold	●	-	-					
NC3FAHR2-0		Black Plastic	Gold	●	-	-					
NC*FAV-D		Black Plastic	Gold	-	●	●					
	NC*MAV	Black Plastic	Gold	●	●	●					
NC*FAV-0		Black Plastic	Gold	●	●	●					
	NC3MAV-0	Black Plastic	Gold	●	-	-					
NC3FAV1-D	NC3MAV-1	Black Plastic	Gold	●	-	-					
NC3FAV1-0		Black Plastic	Gold	●	-	-					
NC3FAV2-D		Black Plastic	Gold	●	-	-					
NC3FAV2-0		Black Plastic	Gold	●	-	-					
NC3FAY-D	NC3MAY	Black Plastic	Gold	●	-	-					
NC3FAY-0		Black Plastic	Gold	●	-	-					
NC5FAV-SW-D	NC5MAV-SW	Black Plastic	Gold	-	-	●					

A Series comes with Push Latch disassembled, assembled Push on request.  
AA Series comes with Push Latch assembled.

A / AA Series rear mount only, all PCB mount except Y version = IDC

## Grounding Options

### A / AA Series and B / BA Series

#### Female

"1"

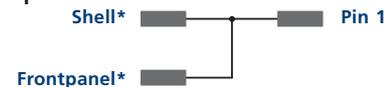

"2"

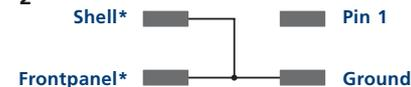

#### Male

w/o number

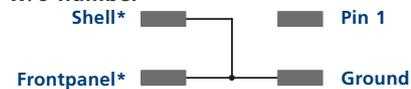

"0"

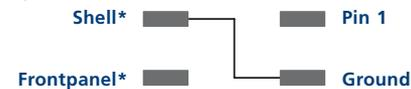

"1"

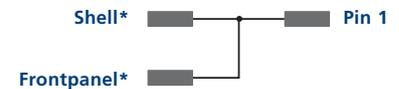

Shell\* ... Contact to shell of mating connector

Frontpanel\* ... Connection to frontpanel by fastening screw

- Quality Design

# Ordering Information

## Ordering Information for Receptacles

Female	Male	Flange	Contact	3 pole	4 pole	5 pole	Female	Male	Flange	Contact	3 pole	4 pole	5 pole
<b>B Series</b>							<b>BA Series</b>						
NC*FBH-D		Metal	Gold	-	●	●	NC3FBAH1-D		Metal	Gold	●	-	-
	NC*MBH	Metal	Gold	●	●	●		NC3MBAH	Metal	Gold	●	-	-
NC*FBH-B-D		Black Metal	Gold	-	●	●	NC3FBAH1-0		Metal	Gold	●	-	-
	NC*MBH-B	Black Metal	Gold	●	-	●		NC3MBAH-0	Metal	Gold	●	-	-
NC3FBH1-D		Metal	Gold	●	-	-	NC3FBAH2-D		Metal	Gold	●	-	-
NC3FBH1-B-D		Black Metal	Gold	●	-	-		NC3MBAH-1	Metal	Gold	●	-	-
NC3FBHL1-D		Metal	Gold	●	-	-	NC3FBAH2-0		Metal	Gold	●	-	-
	NC3MBHL	Metal	Gold	●	-	-	NC3FBAV1-D		Metal	Gold	●	-	-
NC3FBHR1-D		Metal	Gold	●	-	-		NC3MBAV	Metal	Gold	●	-	-
NC3FBH2-D		Metal	Gold	●	-	-	NC3FBAV1-0		Metal	Gold	●	-	-
NC3FBH2-B-D		Black Metal	Gold	●	-	-		NC3MBAV-0	Metal	Gold	●	-	-
NC3FBHR2-D		Metal	Gold	●	-	-	NC3FBAV2-D		Metal	Gold	●	-	-
	NC3MBHR	Metal	Gold	●	-	-		NC3MBAV-1	Metal	Gold	●	-	-
NC*FBV-D		Metal	Gold	-	●	●	NC3FBAV2-0		Metal	Gold	●	-	-
	NC*MBV	Metal	Gold	●	●	●							
NC*FBV-B-D		Black Metal	Gold	-	●	●							
	NC*MBV-B	Black Metal	Gold	●	-	●							
NC3FBV1-D		Metal	Gold	●	-	-							
NC3FBV1-B-D		Black Metal	Gold	●	-	-							
NC3FBV2-D		Metal	Gold	●	-	-							
NC3FBV2-B-D		Black Metal	Gold	●	-	-							
NC3FBY-D	NC3MBY	Metal	Gold	●	-	-							
NC3FBY-B-D	NC3MBY-B	Black Metal	Gold	●	-	-							
NC5FBV-SW-D	NC5MBV-SW	Metal	Gold	-	-	●							
NC3FBH1-E-D	NC3MBV-E	Metal	Gold	●	-	-							
NC3FBH2-E-D		Metal	Gold	●	-	-							
	NC3MBH-E	Metal	Gold	●	-	-							
Special version for 3 pole B-Series with M2.5 mounting holes (-M25) on request.							B / BA Series comes with Push Latch disassembled, assembled Push on request.						
							B / BA Series rear mount only, all PCB mount except Y version = IDC						

Quality Thinking

# Ordering Information

## Ordering Information for Receptacle

Female	Male	Shell	Contact	3	4	5	6	7	Female	Male	Shell	Contact	3	4	5	6	7			
				pole	pole	pole	pole	pole					pole	pole	pole	pole	pole			
<b>D Series</b>									<b>P Series</b>											
NC3FD-V	NC3MD-V	Nickel	Silver	●	-	-	-	-	NC*FP-1		Nickel	Silver	●	●	●	●	●			
NC3FD-V-B	NC3MD-V-B	Black Cr	Gold	●	-	-	-	-		NC*MP	Nickel	Silver	●	●	●	●	-			
NC3FD-V-BAG	NC3MD-V-BAG	Black Cr	Silver	●	-	-	-	-	NC*FP-B-1		Black Cr	Gold	●	●	●	●	●			
NC3FDM3-V	NC3MDM3-V	Nickel	Silver	●	-	-	-	-		NC*MP-B	Black Cr	Gold	●	●	●	●	-			
NC3FDM3-V-B	NC3MDM3-V-B	Black Cr	Gold	●	-	-	-	-	NC*FP-BAG-1	NC*MP-BAG	Black Cr	Silver	●	●	●	●	-			
NC3FD-H	NC3MD-H	Nickel	Silver	●	-	-	-	-												
NC3FD-H-B	NC3MD-H-B	Black Cr	Gold	●	-	-	-	-												
NC3FD-H-BAG	NC3MD-H-BAG	Black Cr	Silver	●	-	-	-	-												
NC3FDM3-H-D	NC3MDM3-H	Nickel	Silver	●	-	-	-	-												
NC3FDM3-H-B-D	NC3MDM3-H-B	Black Cr	Gold	●	-	-	-	-												
NC3FDM3-H-BAG-D	NC3MDM3-H-BAG	Black Cr	Gold	●	-	-	-	-												
<b>DL Series</b>									<b>MPR-HD Series</b>											
NC*FD-L-1	NC*MD-L-1	Nickel	Silver	●	●	●	●	●	-	NC*MPR-HD	Nickel	Gold	●	●	●	-	-			
NC*FD-L-B-1	NC*MD-L-B-1	Black Cr	Gold	●	●	●	●	●												
NC*FD-L-BAG-1	NC*MD-L-BAG-1	Black Cr	Silver	●	●	●	●	-												
NC*FDM3-L-1-D	NC*MDM3-L-1	Nickel	Silver	●	●	●	-	-												
NC3FDM3LBAG-1-D	NC3MDM3LBAG-1	Black Cr	Silver	●	-	-	-	-												
NC3FD-L-1-HE	NC3MD-L-1-HE	Velour Cr	Gold	●	-	-	-	-												
NC*FDM3-H-D	NC*MDM3-H	Nickel	Silver	-	●	●	●	-												
NC*FDM3-H-B-D	NC*MDM3-H-B	Nickel	Silver	-	●	●	●	-												
NC*FDM3-H-BAG-D	NC*MDM3-H-BAG	Black Cr	Silver	-	●	●	●	-												
NC3FD-S-1-B	NC3MD-S-1-B	Black Cr	Silver	●	-	-	-	-												
<b>DLX Series</b>									<b>Combo Series</b>											
NC*FD-LX	NC*MD-LX	Nickel	Silver	●	●	●	●	●												
NC*FD-LX-B	NC*MD-LX-B	Black Cr	Gold	●	●	●	●	●												
NC*FD-LX-BAG	NC*MD-LX-BAG	Black Cr	Silver	●	●	●	●	●												
NC*FD-LX-M3	NC*MD-LX-M3	Nickel	Silver	●	●	●	-	-												
NC3FD-LX-HE	NC3MD-LX-HE	Velour Cr	Gold	●	-	-	-	-												
<b>EMC XLR</b>																				
NC3FDX-EMC-SPEC		Black Cr	Gold	●	-	-	-	-												
<b>Accessories</b>																				
FDR-1		Black round panel mounting flange with screws for larger panel cut-outs																		
									<b>Contact #</b>											
										<b>1</b>	<b>2</b>	<b>3</b>	<b>T</b>	<b>R</b>	<b>S</b>	<b>TN</b>	<b>RN</b>	<b>SN</b>	<b>G</b>	<b>GN</b>
									NCJ5FI-*	x	x	x	x		x				x	
									NCJ6FI-*	x	x	x	x	x	x				x	
									NCJ9FI-*	x	x	x	x	x	x	x	x	x	x	
									NCJ10FI-*	x	x	x	x	x	x	x	x	x	x	x

- Quality Design

# Ordering Information

## Panel Cutouts

A / AA / B / BA Series    D / DL / DLX Series    P Series Female    P Series Male    Combo    MPR Series

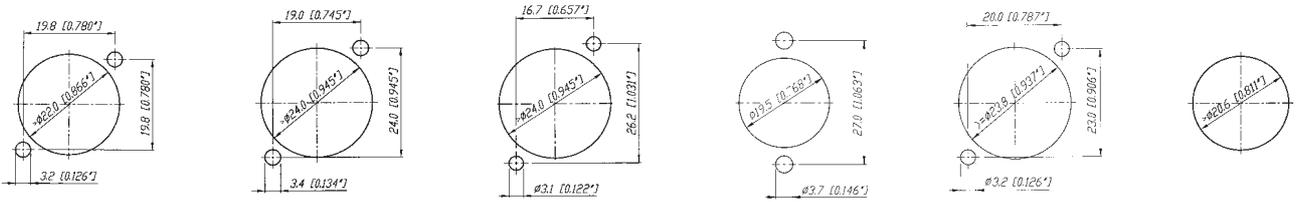

## Assembly Tools

**HTX** Hand tool to tighten the X / XX-bushing



**BTXX** Assembly fixture to tightening the XX-bushing



**HX-R-BNC** Crimp tool for XCC Series



**DIE-R-BNC-PT** Crimp die for XCC Series (6.5 mm HEX)





Компания «ЭлектроПласт» предлагает заключение долгосрочных отношений при поставках импортных электронных компонентов на взаимовыгодных условиях!

Наши преимущества:

- Оперативные поставки широкого спектра электронных компонентов отечественного и импортного производства напрямую от производителей и с крупнейших мировых складов;
- Поставка более 17-ти миллионов наименований электронных компонентов;
- Поставка сложных, дефицитных, либо снятых с производства позиций;
- Оперативные сроки поставки под заказ (от 5 рабочих дней);
- Экспресс доставка в любую точку России;
- Техническая поддержка проекта, помощь в подборе аналогов, поставка прототипов;
- Система менеджмента качества сертифицирована по Международному стандарту ISO 9001;
- Лицензия ФСБ на осуществление работ с использованием сведений, составляющих государственную тайну;
- Поставка специализированных компонентов (Xilinx, Altera, Analog Devices, Intersil, Interpoint, Microsemi, Aeroflex, Peregrine, Syfer, Eurofarad, Texas Instrument, Miteq, Cobham, E2V, MA-COM, Hittite, Mini-Circuits, General Dynamics и др.);

Помимо этого, одним из направлений компании «ЭлектроПласт» является направление «Источники питания». Мы предлагаем Вам помощь Конструкторского отдела:

- Подбор оптимального решения, техническое обоснование при выборе компонента;
- Подбор аналогов;
- Консультации по применению компонента;
- Поставка образцов и прототипов;
- Техническая поддержка проекта;
- Защита от снятия компонента с производства.



#### Как с нами связаться

**Телефон:** 8 (812) 309 58 32 (многоканальный)

**Факс:** 8 (812) 320-02-42

**Электронная почта:** [org@eplast1.ru](mailto:org@eplast1.ru)

**Адрес:** 198099, г. Санкт-Петербург, ул. Калинина, дом 2, корпус 4, литера А.