

## 0.9 V to 2.5 V, 55 mΩ Load Switch in WCSP4

### DESCRIPTION

SiP32451, SiP32452 and SiP32453 are n-channel integrated high side load switches that operate from 0.9 V to 2.5 V input voltage range.

SiP32451, SiP32452 and SiP32453 have low input logic control threshold that can interface with low voltage control GPIO directly without extra level shift or driver. There is a pull down at this EN logic control pin.

Turn on time is fast, less than 25  $\mu$ s typically for input voltage of 1.2 V or higher. SiP32451 and SiP32452 have fast turn off delay time of less than 1  $\mu$ s while SiP32453 features a guaranteed turn off delay of greater than 30  $\mu$ s, typically 90  $\mu$ s.

SiP32451 features an output discharge for fast turn off.

SiP32451, SiP32452 and SiP32453 are available in compact wafer level CSP package, WCSP4 0.8 mm x 0.8 mm with 0.4 mm pitch.

### FEATURES

- Low input voltage, 0.9 V to 2.5 V
- Low  $R_{ON}$ , 55 m $\Omega$  typical
- Fast turn on time
- Low logic control with hysteresis
- Reverse current blocking when disabled
- Integrated pull down at EN pin
- Output discharge (SiP32451)
- 4 bump WCSP 0.8 mm x 0.8 mm with 0.4 mm pitch package
- Material categorization: For definitions of compliance please see [www.vishay.com/doc?9991](http://www.vishay.com/doc?9991)



### APPLICATIONS

- Battery operated devices
- Smart phones
- GPS and PMP
- Computer
- Medical and healthcare equipment
- Industrial and instrument
- Cellular phones and portable media players
- Game console

### TYPICAL APPLICATION CIRCUIT

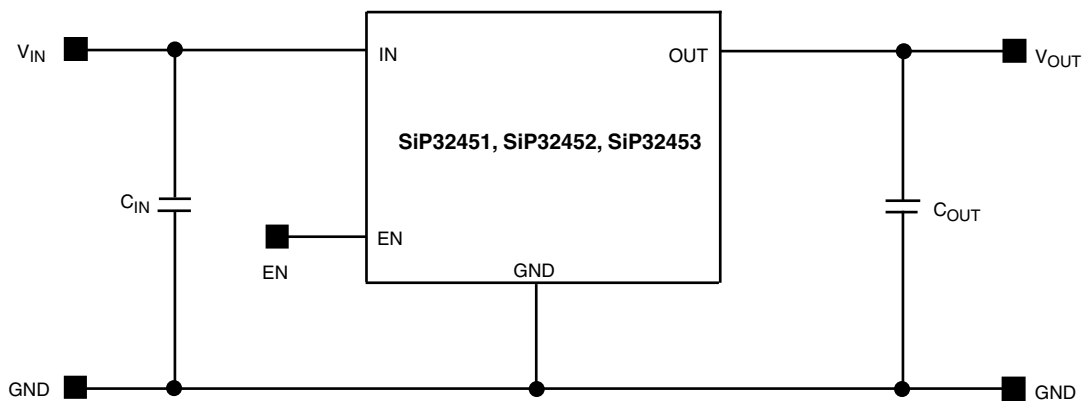

Figure 1 - SiP32451, SiP32452, and SiP32453 Typical Application Circuit

ORDERING INFORMATION			
Temperature Range	Package	Marking	Part Number
- 40 °C to 85 °C	WCSP4: 4 Bumps (2 x 2, 0.4 mm pitch, 208 µm bump height, 0.8 mm x 0.8 mm die size)	AA	SiP32451DB-T2-GE1
		AB	SiP32452DB-T2-GE1
		AC	SiP32453DB-T2-GE1

Note:

GE1 denotes halogen-free and RoHS compliant

ABSOLUTE MAXIMUM RATINGS		
Parameter	Limit	Unit
Supply Input Voltage ( $V_{IN}$ )	- 0.3 to 2.75	V
Enable Input Voltage ( $V_{EN}$ )	- 0.3 to 2.75	
Output Voltage ( $V_{OUT}$ )	- 0.3 to 2.75	
Maximum Continuous Switch Current ( $I_{max.}$ )	1.2	A
Maximum Pulsed Current ( $I_{DM}$ ) $V_{IN}$ (Pulsed at 1 ms, 10 % duty cycle)	2	
ESD Rating (HBM)	4000	V
Junction Temperature ( $T_J$ )	- 40 to 150	°C
Thermal Resistance ( $\theta_{JA}$ ) <sup>a</sup>	280	°C/W
Power Dissipation ( $P_D$ ) <sup>a</sup>	196	mW

Notes:

a. Device mounted with all leads and power pad soldered or welded to PC board.

b. Derate 3.6 mW/°C above  $T_A = 70$  °C.

Stresses beyond those listed under "Absolute Maximum Ratings" may cause permanent damage to the device. These are stress ratings only, and functional operation of the device at these or any other conditions beyond those indicated in the operational sections of the specifications is not implied. Exposure to absolute maximum rating/conditions for extended periods may affect device reliability.

RECOMMENDED OPERATING RANGE		
Parameter	Limit	Unit
Input Voltage Range ( $V_{IN}$ )	0.9 to 2.5	V
Operating Junction Temperature Range	- 40 to 125	°C



SPECIFICATIONS							
Parameter	Symbol	Test Conditions Unless Specified $V_{IN} = 1\text{ V}$ , $T_A = -40\text{ }^\circ\text{C}$ to $85\text{ }^\circ\text{C}$ (Typical values are at $T_A = 25\text{ }^\circ\text{C}$ )	Limits			Unit	
			Min. <sup>a</sup>	Typ. <sup>b</sup>	Max. <sup>a</sup>		
Operating Voltage <sup>c</sup>	$V_{IN}$		0.9	-	2.5	V	
Quiescent Current	$I_Q$	$V_{IN} = 1.2\text{ V}$ , $V_{EN} = V_{IN}$ , OUT = open	-	10	15	$\mu\text{A}$	
		$V_{IN} = 2.5\text{ V}$ , $V_{EN} = V_{IN}$ , OUT = open	-	34	60		
Off Supply Current	$I_{Q(off)}$	SiP32451	EN = GND, OUT = open	-	-		30
		SiP32452, SiP32453		-	-		1
Off Switch Current	$I_{DS(off)}$	EN = GND, OUT = 0 V	-	-	30		
Reverse Blocking Current	$I_{RB}$	$V_{OUT} = 2.5\text{ V}$ , $V_{IN} = 0.9\text{ V}$ , $V_{EN} = 0\text{ V}$	-	0.001	10		
On-Resistance	$R_{DS(on)}$	$V_{IN} = 1\text{ V}$ , $I_L = 200\text{ mA}$ , $T_A = 25\text{ }^\circ\text{C}$	-	56	65	$\text{m}\Omega$	
		$V_{IN} = 1.2\text{ V}$ , $I_L = 200\text{ mA}$ , $T_A = 25\text{ }^\circ\text{C}$	-	55	65		
		$V_{IN} = 1.8\text{ V}$ , $I_L = 200\text{ mA}$ , $T_A = 25\text{ }^\circ\text{C}$	-	54	65		
		$V_{IN} = 2.5\text{ V}$ , $I_L = 200\text{ mA}$ , $T_A = 25\text{ }^\circ\text{C}$	-	54	65		
On-Resistance Temp.-Coefficient	$TC_{RDS}$		-	3900	-	$\text{ppm}/^\circ\text{C}$	
Output Pulldown Resistance	$R_{PD}$	$V_{EN} = 0\text{ V}$ , $T_A = 25\text{ }^\circ\text{C}$ (SiP32451 only)	-	425	550	$\Omega$	
EN Input Low Voltage <sup>c</sup>	$V_{IL}$	$V_{IN} = 1\text{ V}$	-	-	0.1	V	
EN Input High Voltage <sup>c</sup>	$V_{IH}$	$V_{IN} = 2.5\text{ V}$	1.5	-	-		
EN Input Leakage	$I_{EN}$	$V_{IN} = 2.5\text{ V}$ , $V_{EN} = 0\text{ V}$	-	-	1	$\mu\text{A}$	
		$V_{IN} = 2.5\text{ V}$ , $V_{EN} = 2.5\text{ V}$	-	10	15		
Output Turn-On Delay Time	$t_{d(on)}$	$V_{IN} = 1.2\text{ V}$	$R_{LOAD} = 10\ \Omega$ , $C_L = 0.1\ \mu\text{F}$ , $T_A = 25\text{ }^\circ\text{C}$	-	0.4	1	$\mu\text{s}$
		$V_{IN} = 2.5\text{ V}$		-	0.05	1	
Output Turn-On Rise Time	$t_r$	$V_{IN} = 1.2\text{ V}$		10	20	30	
		$V_{IN} = 2.5\text{ V}$		5	9.8	20	
Output Turn-Off Delay Time	$t_{d(off)}$	SiP32451, SiP32452 $V_{IN} = 1.2\text{ V}$		-	0.25	1	
		SiP32451, SiP32452 $V_{IN} = 2.5\text{ V}$		-	0.15	1	
		SiP32453, $V_{IN} = 1.2\text{ V}$		30	98	150	
		SiP32453, $V_{IN} = 2.5\text{ V}$		30	86	150	

Notes:

- a. The algebraic convention whereby the most negative value is a minimum and the most positive a maximum.
- b. Typical values are for DESIGN AID ONLY, not guaranteed nor subject to production testing.
- c. For  $V_{IN}$  outside this range consult typical EN threshold curve.

### PIN CONFIGURATION

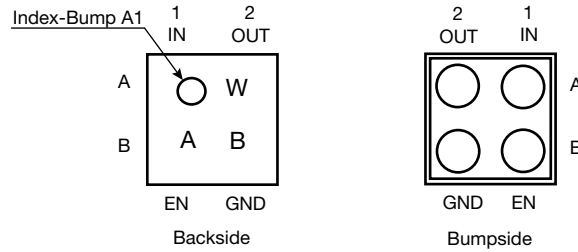

Figure 2 - WCSP4 2 x 2 Package

### PIN DESCRIPTION

Pin Number	Name	Function
A1	IN	This pin is the n-channel MOSFET drain connection. Bypass to ground through a 4.7 $\mu\text{F}$ capacitor.
A2	OUT	This pin is the n-channel MOSFET source connection. Bypass to ground through a 0.1 $\mu\text{F}$ capacitor.
B1	EN	Enable input
B2	GND	Ground connection

### TYPICAL CHARACTERISTICS (internally regulated, 25 $^{\circ}\text{C}$ , unless otherwise noted)

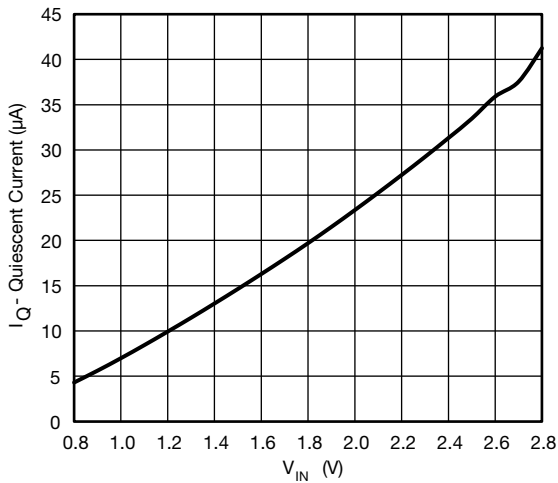

Figure 3 - Quiescent Current vs. Input Voltage

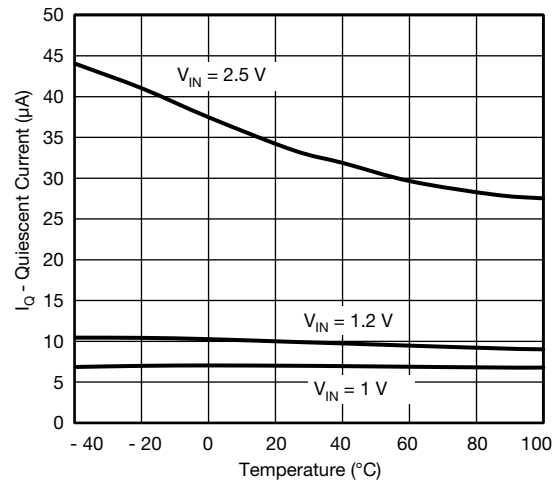

Figure 5 - Quiescent Current vs. Temperature

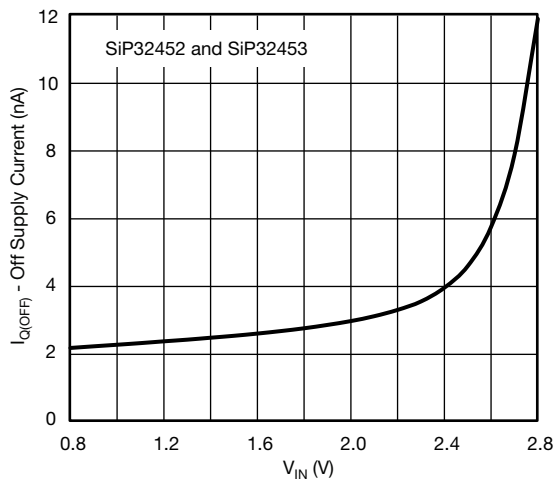

Figure 4 - Off Supply Current vs. Input Voltage

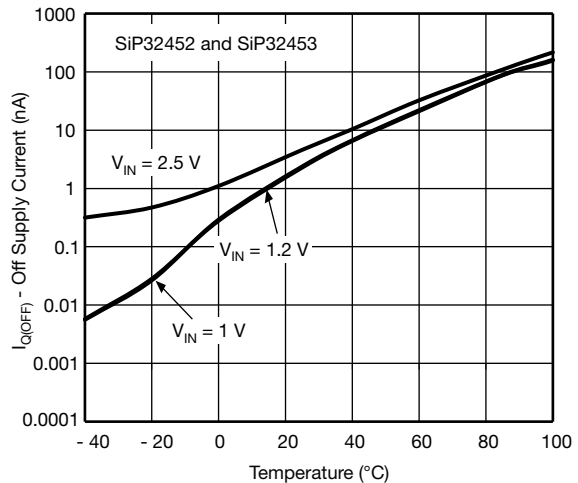

Figure 6 - Off Supply Current vs. Temperature

**TYPICAL CHARACTERISTICS** (internally regulated, 25 °C, unless otherwise noted)

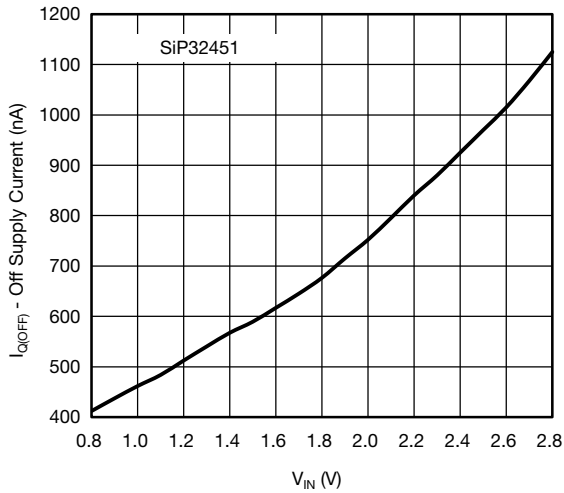

Figure 7 - Off Supply Current vs. Input Voltage

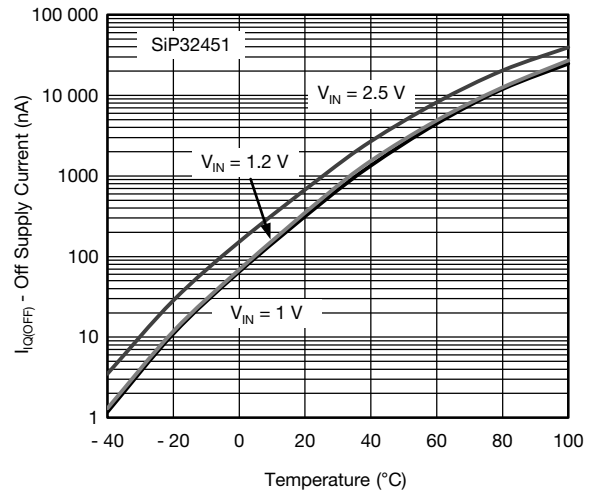

Figure 10 - Off Supply Current vs. Temperature

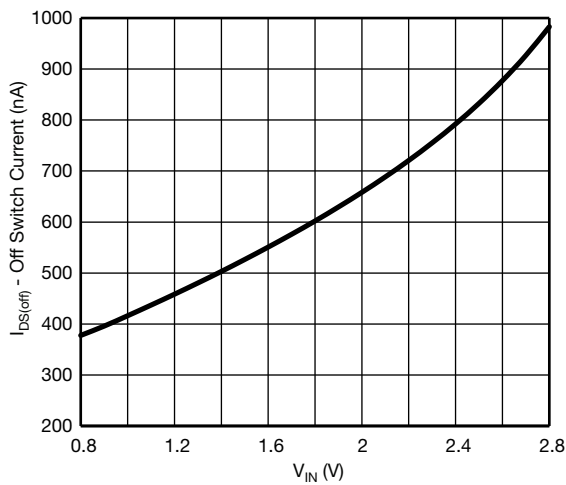

Figure 8 - Off Switch Current vs. Input Voltage

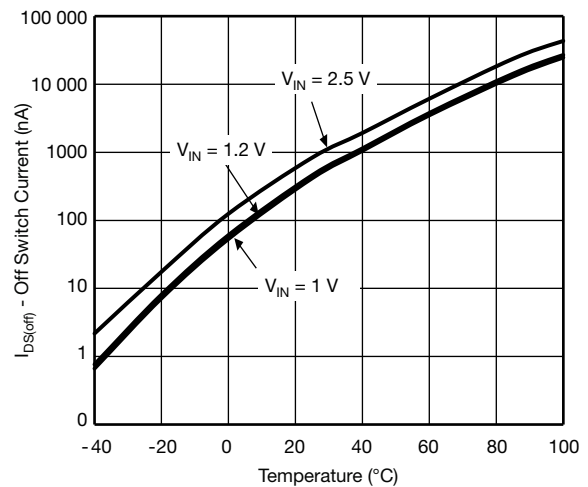

Figure 11 - Off Switch Current vs. Temperature

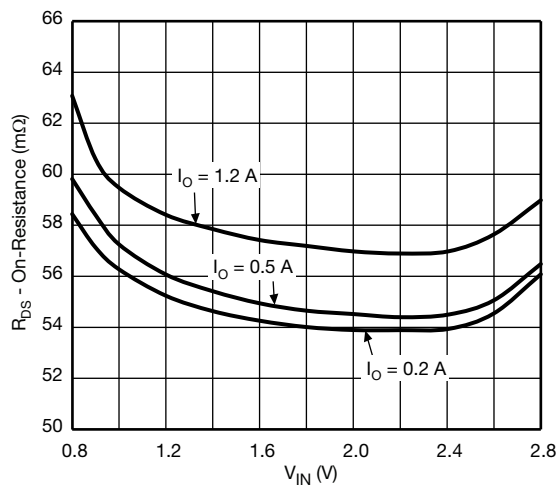

Figure 9 -  $R_{DS(on)}$  vs.  $V_{IN}$

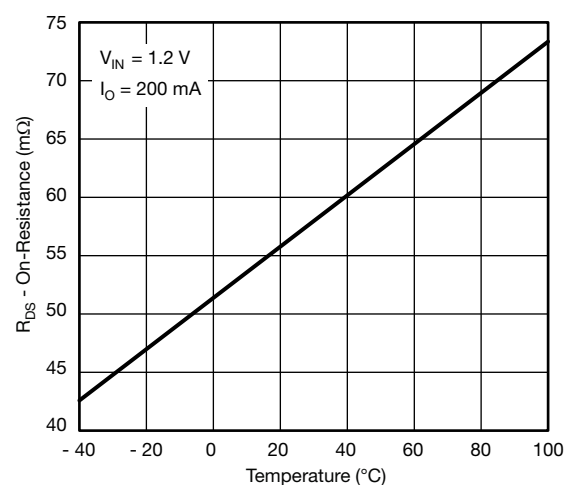

Figure 12 -  $R_{DS(on)}$  vs. Temperature

**TYPICAL CHARACTERISTICS** (internally regulated, 25 °C, unless otherwise noted)

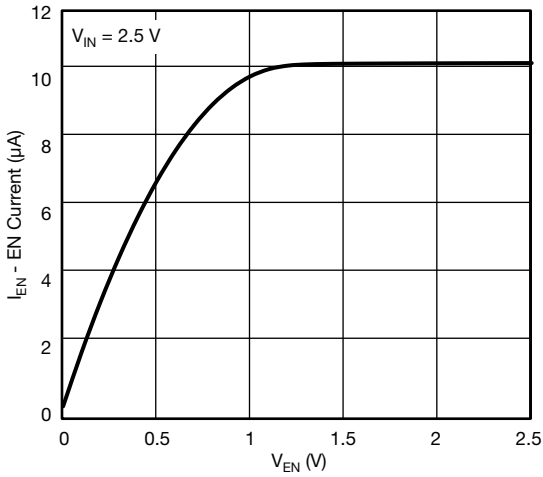

Figure 13 - I<sub>EN</sub> vs. V<sub>EN</sub>

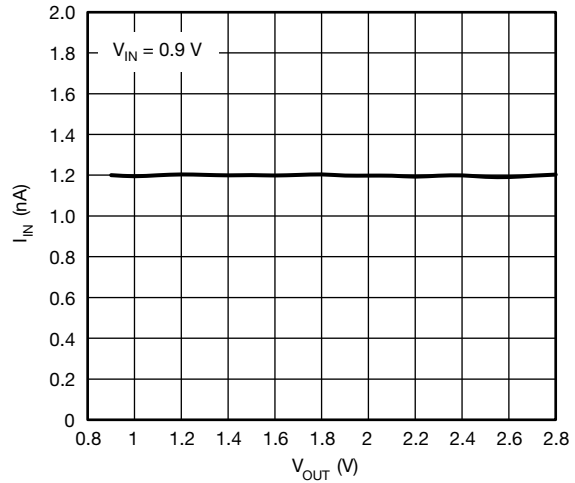

Figure 16 - Reverse Blocking Current vs. Output Voltage

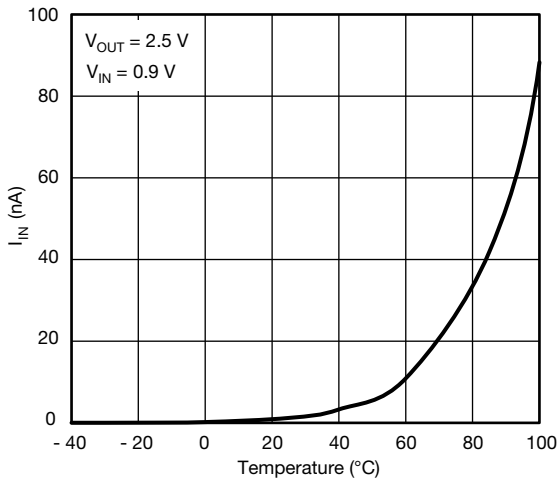

Figure 14 - Reverse Blocking Current vs. Temperature

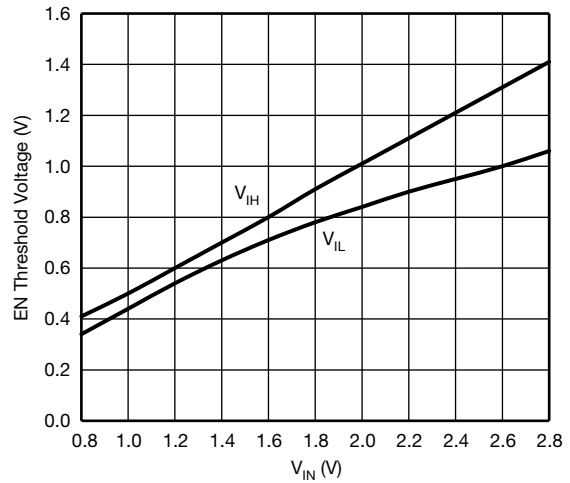

Figure 17 - EN Threshold Voltage vs. Input Voltage

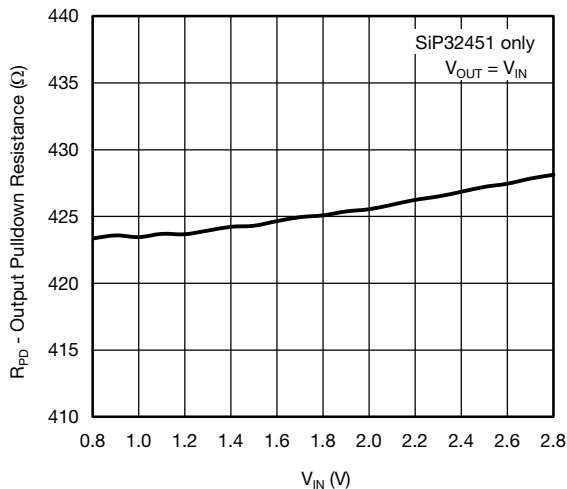

Figure 15 - Output Pulldown Resistance vs. Input Voltage

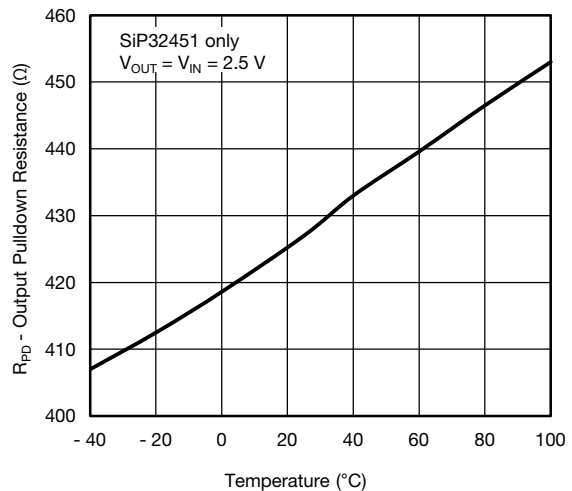

Figure 18 - Output Pulldown Resistance vs. Temperature

**TYPICAL CHARACTERISTICS** (internally regulated, 25 °C, unless otherwise noted)

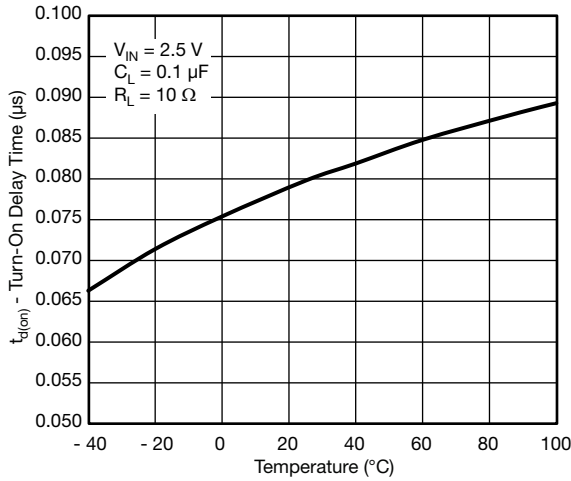

Figure 19 - Turn-On Delay Time vs. Temperature

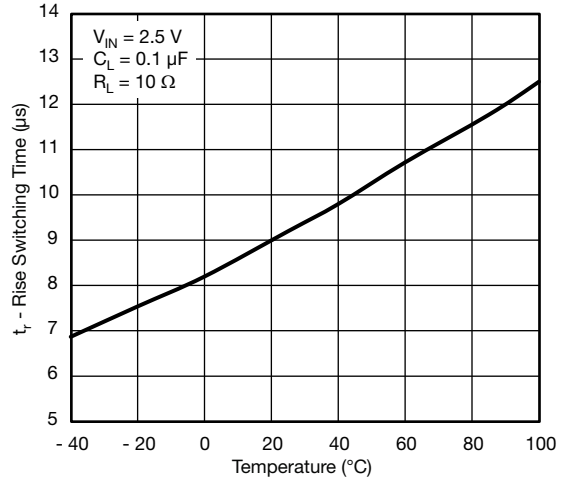

Figure 21 - Rise Time vs. Temperature

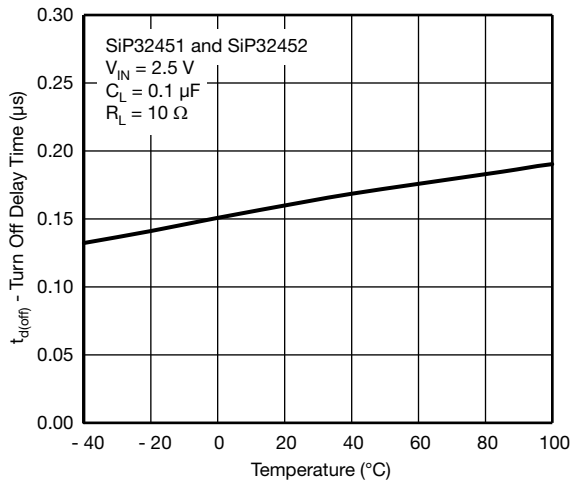

Figure 20 - Turn-Off Delay Time vs. Temperature

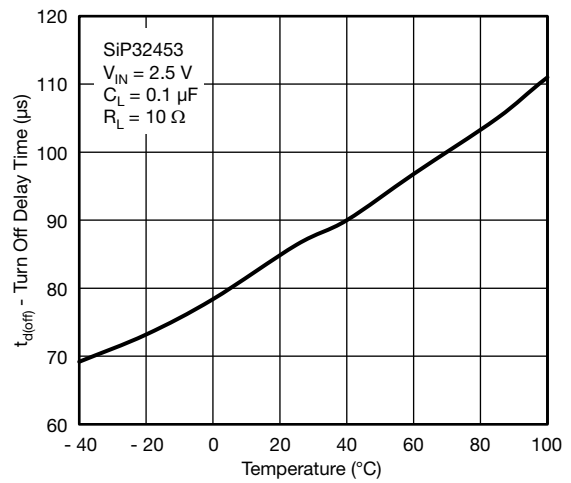

Figure 22 - Turn-Off Delay Time vs. Temperature

## TYPICAL WAVEFORMS

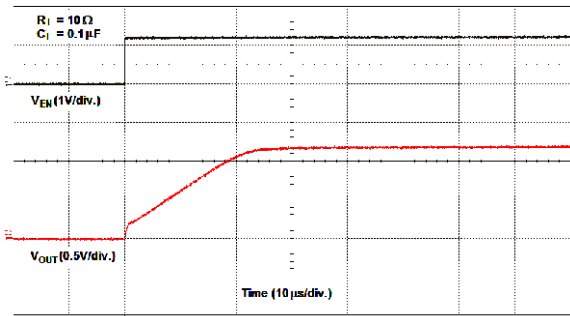

Figure 23 - Turn-On Time ( $V_{IN} = 1.2\text{ V}$ )

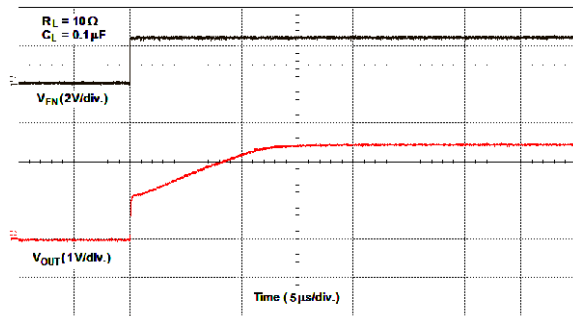

Figure 26 - Turn-On Time ( $V_{IN} = 2.5\text{ V}$ )

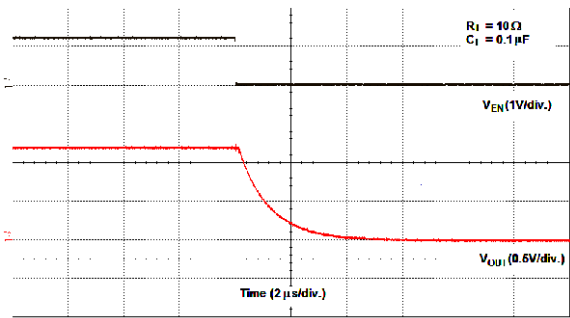

Figure 24 - SiP32451 and SiP32452 Turn-Off Time ( $V_{IN} = 1.2\text{ V}$ )

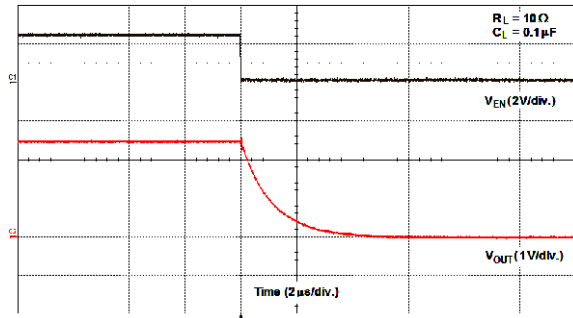

Figure 27 - SiP32451 and SiP32452 Turn-Off Time ( $V_{IN} = 2.5\text{ V}$ )

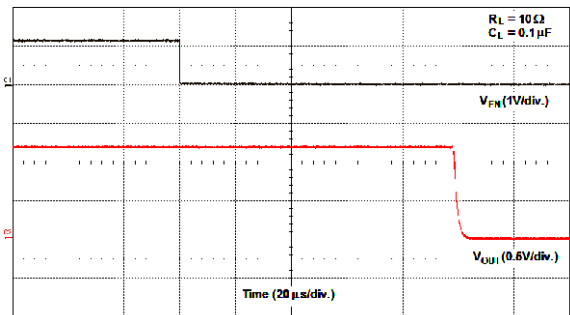

Figure 25 - SiP32453 Turn-Off Time ( $V_{IN} = 1.2\text{ V}$ )

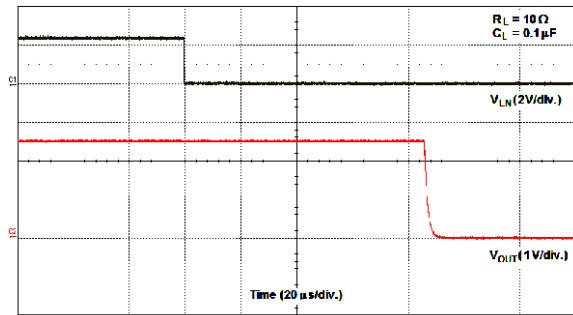

Figure 28 - SiP32453 Turn-Off Time ( $V_{IN} = 2.5\text{ V}$ )

## BLOCK DIAGRAM

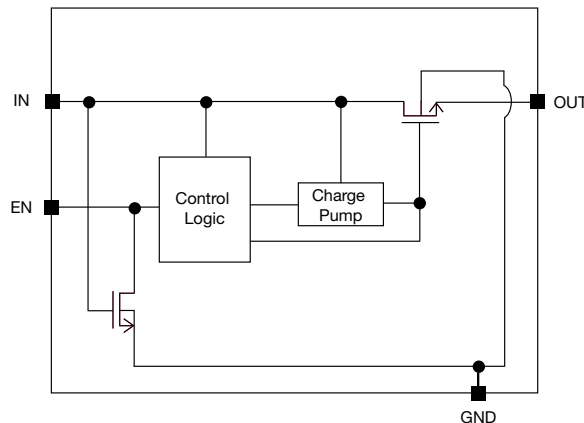

Figure 29 - Functional Block Diagram





### DETAILED DESCRIPTION

SiP32451, SiP32452 and SiP32453 are n-channel power MOSFET designed as high side load switch. Once enable the device charge pumps the gate of the power MOSFET to a constant gate to source voltage for fast turn on time. The mostly constant gate to source voltage keeps the on resistance low through out the input voltage range. When disable, the SiP32451 and SiP32452 pull the gate of the output n-channel low right away for a fast turn off delay while there is a build-in turn off delay for the SiP32453. The SiP32451 especially features a output discharge circuit to help discharge the output capacitor. The turn off delay for the SiP32453 is guaranteed to be at least 30  $\mu$ s. Because the body of the output n-channel is always connected to GND, it prevents the current from going back to the input in case the output voltage is higher than the output.

### APPLICATION INFORMATION

#### Input Capacitor

While a bypass capacitor on the input is not required, a 4.7  $\mu$ F or larger capacitor for  $C_{IN}$  is recommended in almost all applications. The bypass capacitor should be placed as physically close as possible to the input pin to be effective in minimizing transients on the input. Ceramic capacitors are recommended over tantalum because of their ability to withstand input current surges from low impedance sources such as batteries in portable devices.

#### Output Capacitor

A 0.1  $\mu$ F capacitor across  $V_{OUT}$  and GND is recommended to insure proper slew operation. There is inrush current through the output MOSFET and the magnitude of the inrush current depends on the output capacitor, the bigger the  $C_{OUT}$  the higher the inrush current. There are no ESR or capacitor type requirement.

#### Enable

The EN pin is compatible with CMOS logic voltage levels. It requires at least 0.1 V or below to fully shut down the device and 1.5 V or above to fully turn on the device.

#### Protection Against Reverse Voltage Condition

SiP32451, SiP32452 and SiP32453 can block the output current from going to the input in case where the output voltage is higher than the input voltage when the main switch is off.

#### Thermal Considerations

These devices are designed to maintain a constant output load current. Due to physical limitations of the layout and assembly of the device the maximum switch current is 1.2 A as stated in the Absolute Maximum Ratings table. However, another limiting characteristic for the safe operating load current is the thermal power dissipation of the package. To obtain the highest power dissipation (and a thermal resistance of 280  $^{\circ}$ C/W) the device should be connected to a heat sink on the printed circuit board.

The maximum power dissipation in any application is dependant on the maximum junction temperature,  $T_{J(max.)} = 125^{\circ}$ C, the junction-to-ambient thermal resistance,  $\theta_{J-A} = 280^{\circ}$ C/W, and the ambient temperature,  $T_A$ , which may be formulaically expressed as:

$$P (max.) = \frac{T_J (max.) - T_A}{\theta_{J-A}} = \frac{125 - T_A}{280}$$

It then follows that, assuming an ambient temperature of 70  $^{\circ}$ C, the maximum power dissipation will be limited to about 196 mW.

So long as the load current is below the 1.2 A limit, the maximum continuous switch current becomes a function two things: the package power dissipation and the  $R_{DS(ON)}$  at the ambient temperature.

As an example let us calculate the worst case maximum load current at  $T_A = 70^{\circ}$ C. The worst case  $R_{DS(ON)}$  at 25  $^{\circ}$ C is 65 m $\Omega$ . The  $R_{DS(ON)}$  at 70  $^{\circ}$ C can be extrapolated from this data using the following formula:

$$R_{DS(ON)} (at 70^{\circ}C) = R_{DS(ON)} (at 25^{\circ}C) \times (1 + T_C \times \Delta T)$$

Where  $T_C$  is 3900 ppm/ $^{\circ}$ C. Continuing with the calculation we have

$$R_{DS(ON)} (at 70^{\circ}C) = 65 m\Omega \times (1 + 0.0039 \times (70^{\circ}C - 25^{\circ}C)) = 76.4 m\Omega$$

The maximum current limit is then determined by

$$I_{LOAD} (max.) < \sqrt{\frac{P (max.)}{R_{DS(ON)}}}$$

which in this case is 1.6 A. Under the stated input voltage condition, if the 1.6 A current limit is exceeded the internal die temperature will rise and eventually, possibly damage the device.

To avoid possible permanent damage to the device and keep a reasonable design margin, it is recommended to operate the device maximum up to 1.2 A only as listed in the Absolute Maximum Ratings table.

### PACKAGE OUTLINE

WCSP4: 4 Bumps (2 x 2, 0.4 mm Pitch, 208 μm Bump Height, 0.8 mm x 0.8 mm Die Size)

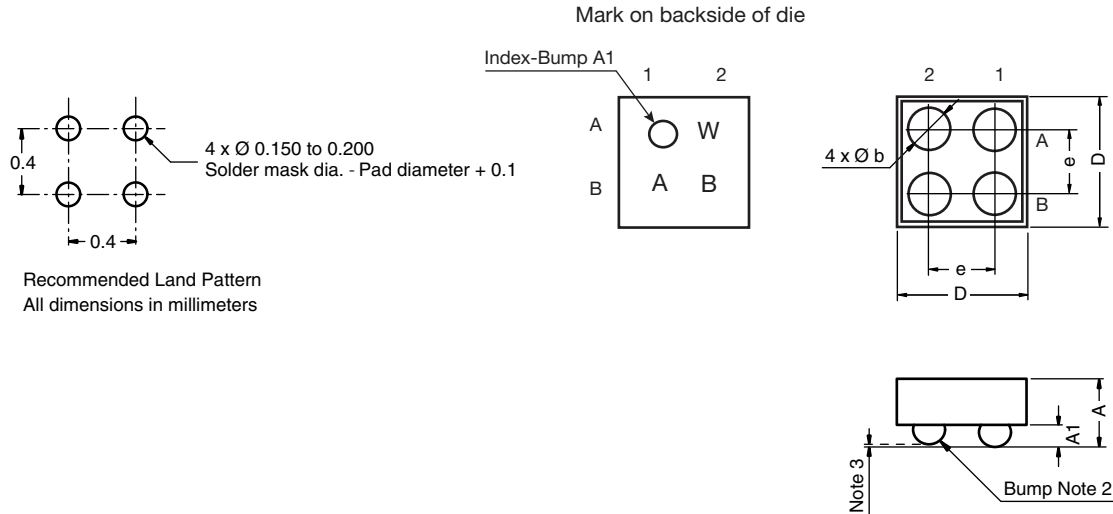

Dimension	MILLIMETERS			INCHES		
	Min.	Nom.	MAX.	Min.	Nom.	MAX.
A	0.515	0.530	0.545	0.0202	0.0208	0.0214
A1	0.208			0.0081		
b	0.250	0.260	0.270	0.0098	0.0102	0.0106
e	0.400			0.0157		
D	0.720	0.760	0.800	0.0182	0.0193	0.0203

Notes:

1. Laser mark on the backside surface of die.
2. Bumps are SAC396.
3. 0.050 max. coplanarity.

Vishay Siliconix maintains worldwide manufacturing capability. Products may be manufactured at one of several qualified locations. Reliability data for Silicon Technology and Package Reliability represent a composite of all qualified locations. For related documents such as package/tape drawings, part marking, and reliability data, see [www.vishay.com/ppg?63315](http://www.vishay.com/ppg?63315)



## Disclaimer

ALL PRODUCT, PRODUCT SPECIFICATIONS AND DATA ARE SUBJECT TO CHANGE WITHOUT NOTICE TO IMPROVE RELIABILITY, FUNCTION OR DESIGN OR OTHERWISE.

Vishay Intertechnology, Inc., its affiliates, agents, and employees, and all persons acting on its or their behalf (collectively, "Vishay"), disclaim any and all liability for any errors, inaccuracies or incompleteness contained in any datasheet or in any other disclosure relating to any product.

Vishay makes no warranty, representation or guarantee regarding the suitability of the products for any particular purpose or the continuing production of any product. To the maximum extent permitted by applicable law, Vishay disclaims (i) any and all liability arising out of the application or use of any product, (ii) any and all liability, including without limitation special, consequential or incidental damages, and (iii) any and all implied warranties, including warranties of fitness for particular purpose, non-infringement and merchantability.

Statements regarding the suitability of products for certain types of applications are based on Vishay's knowledge of typical requirements that are often placed on Vishay products in generic applications. Such statements are not binding statements about the suitability of products for a particular application. It is the customer's responsibility to validate that a particular product with the properties described in the product specification is suitable for use in a particular application. Parameters provided in datasheets and/or specifications may vary in different applications and performance may vary over time. All operating parameters, including typical parameters, must be validated for each customer application by the customer's technical experts. Product specifications do not expand or otherwise modify Vishay's terms and conditions of purchase, including but not limited to the warranty expressed therein.

Except as expressly indicated in writing, Vishay products are not designed for use in medical, life-saving, or life-sustaining applications or for any other application in which the failure of the Vishay product could result in personal injury or death. Customers using or selling Vishay products not expressly indicated for use in such applications do so at their own risk. Please contact authorized Vishay personnel to obtain written terms and conditions regarding products designed for such applications.

No license, express or implied, by estoppel or otherwise, to any intellectual property rights is granted by this document or by any conduct of Vishay. Product names and markings noted herein may be trademarks of their respective owners.

## Material Category Policy

**Vishay Intertechnology, Inc. hereby certifies that all its products that are identified as RoHS-Compliant fulfill the definitions and restrictions defined under Directive 2011/65/EU of The European Parliament and of the Council of June 8, 2011 on the restriction of the use of certain hazardous substances in electrical and electronic equipment (EEE) - recast, unless otherwise specified as non-compliant.**

**Please note that some Vishay documentation may still make reference to RoHS Directive 2002/95/EC. We confirm that all the products identified as being compliant to Directive 2002/95/EC conform to Directive 2011/65/EU.**

**Vishay Intertechnology, Inc. hereby certifies that all its products that are identified as Halogen-Free follow Halogen-Free requirements as per JEDEC JS709A standards. Please note that some Vishay documentation may still make reference to the IEC 61249-2-21 definition. We confirm that all the products identified as being compliant to IEC 61249-2-21 conform to JEDEC JS709A standards.**



Компания «ЭлектроПласт» предлагает заключение долгосрочных отношений при поставках импортных электронных компонентов на взаимовыгодных условиях!

Наши преимущества:

- Оперативные поставки широкого спектра электронных компонентов отечественного и импортного производства напрямую от производителей и с крупнейших мировых складов;
- Поставка более 17-ти миллионов наименований электронных компонентов;
- Поставка сложных, дефицитных, либо снятых с производства позиций;
- Оперативные сроки поставки под заказ (от 5 рабочих дней);
- Экспресс доставка в любую точку России;
- Техническая поддержка проекта, помощь в подборе аналогов, поставка прототипов;
- Система менеджмента качества сертифицирована по Международному стандарту ISO 9001;
- Лицензия ФСБ на осуществление работ с использованием сведений, составляющих государственную тайну;
- Поставка специализированных компонентов (Xilinx, Altera, Analog Devices, Intersil, Interpoint, Microsemi, Aeroflex, Peregrine, Syfer, Eurofarad, Texas Instrument, Miteq, Cobham, E2V, MA-COM, Hittite, Mini-Circuits, General Dynamics и др.);

Помимо этого, одним из направлений компании «ЭлектроПласт» является направление «Источники питания». Мы предлагаем Вам помощь Конструкторского отдела:

- Подбор оптимального решения, техническое обоснование при выборе компонента;
- Подбор аналогов;
- Консультации по применению компонента;
- Поставка образцов и прототипов;
- Техническая поддержка проекта;
- Защита от снятия компонента с производства.



#### Как с нами связаться

**Телефон:** 8 (812) 309 58 32 (многоканальный)

**Факс:** 8 (812) 320-02-42

**Электронная почта:** [org@eplast1.ru](mailto:org@eplast1.ru)

**Адрес:** 198099, г. Санкт-Петербург, ул. Калинина, дом 2, корпус 4, литера А.