

# SB350® Connectors - up to 450 Amps



The SB®350 is the largest connector in the series with power capabilities up to 450 amps with 4/0 wire. Wires ranging from #1/0 (50 mm<sup>2</sup>) to 300 mcm (152 mm<sup>2</sup>) fit into the one piece housing available in standard PC or a chemical resistant PBT/PC blend. Silver plated wire or busbar contacts minimize electrical resistance while offering supreme durability and reliability.

- **Up to 300 mcm (152 mm<sup>2</sup>) Wires**  
*Allows UL rated currents up to 450 amps with 4/0 wire*
- **Chemical Resistant Housing Option**  
*Extends temperature range down to -40°C, while offering enhanced UV and chemical resistance*
- **Same Housings Used for Wire and Busbar Contacts**  
*Enables color-coded mechanically keyed wire to busbar connections*

## | SB®350 ORDERING INFORMATION |

### SB®350 Standard Housings

The largest SB® housings work with wire contacts up to 300 mcm [150 mm<sup>2</sup>] as well as busbar contacts. Genderless design mates with itself. Mechanical keys are color coded. NOTE: SB350 Black and Blue Housings have the same keying features and can be intermated.

Description	Voltage		Part Numbers	
	Color	Code	---	---
Minimum Quantity .....			50	25 ...
Yellow	12V	914-BK	914	
Orange	18V	932-BK	932	
Red	24V	913-BK	913	
Gray	36V	906-BK	906	
Blue	48V	912-BK	912	
Green	72V	931-BK	931	
Black	80V	2-7250G8	-	

### SB®350 Chemical Resistant Housings

Same features as the Standard SB®350 but molded in a chemical resistant PBT/ PC blend. Suitable for use to -40°C.

Description	Voltage		Part Numbers	
	Color	Code	---	---
Minimum Quantity .....			50	25 ....
Red	24V	P913-BK	P913	
Gray	36V	P906-BK	P906	

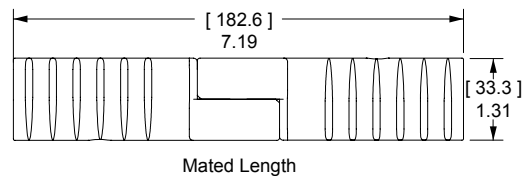
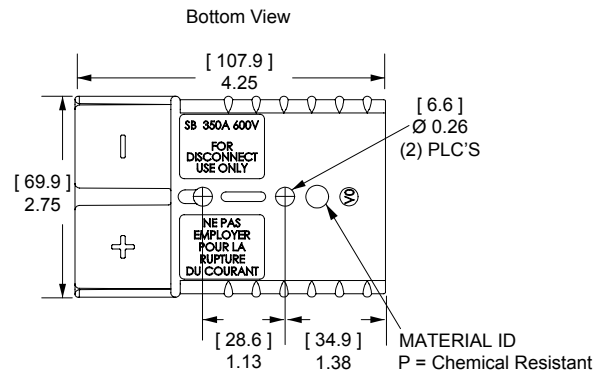

## SB®350 Silver Plated Wire Contacts

Silver plated contacts offer superior electrical performance and durability up to 10,000 mating cycles.

AWG	mm <sup>2</sup>	Mating Force	- Loose Piece Part Numbers -			Dimensions			
						- A -		- B -	
					inches	mm	inches	mm	
Minimum Quantity .....			200	150	50				
300mcm	152	High	-	910-BK	910	0.75	19.05	0.87	22.10
4/0	107.2	High	908-BK	-	908	0.64	16.26	0.75	19.05
3/0	85	High	916-BK	-	916	0.58	14.73	0.70	17.78
2/0	67.4	High	907-BK	-	907	0.49	12.45	0.64	16.26
1/0	53.5	High	917-BK	-	917	0.44	11.18	0.51	12.95



## SB®350 Silver Plated Busbar Contacts

Use 2 busbar contacts per housing to provide a quick disconnect input or output busbar connection. Busbar contacts are for mating with wire contacts only. Part number 350BBS includes lock nuts. Locknuts must be ordered separately for B01998P1.

Type	Thread	Mating Force	- Loose Piece Part Numbers -	
Minimum Quantity .....			50	10
Busbar	1/4-20	High	B01998P1	350BBS
Lock Nut	1/4-20	-	H1216P9	110G73

See Busbar contact drawing on website for further detail.

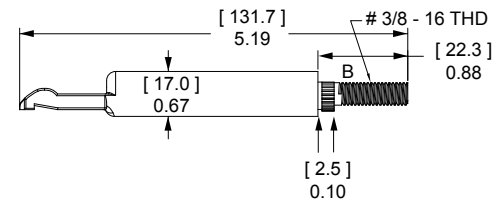

## | SB®350 CONNECTOR SPECIFICATIONS |

### Electrical

<b>Current Rating Amperes<sup>1</sup></b>	<b>UL 1977</b>	<b>CSA</b>
Wire to Wire (4/0 AWG)	450	350
<b>Voltage Rating AC/DC</b>	600	
UL 1977		
<b>Dielectric Withstanding Voltage</b>	2,200	
Volts AC		
<b>Avg. Mated Contact Resistance Milliohms<sup>1</sup></b>	0.050	
2 1/2" of 300mcm wire		
<b>Hot Plug Current Rating Amperes - Wire &amp; Busbar</b>	100A	
250 cycles at 120V DC		

### Materials

<b>Housing</b>	
Standard Plastic Resin	Polycarbonate
Chem. Resistant Resin	Polycarbonate / PBT blend
Contact Retention Spring	Stainless Steel

### Housing Flammability Rating

UL94	V-0
------	-----

### Wire & Busbar Contacts

Base	Copper Alloy
Plating	Silver

### Contact Termination Methods

Crimp <sup>3</sup>	Wire Contacts
Hand Solder	Wire Contacts
Wrench / Socket	Busbar Contacts

### Mechanical

<b>Wire Size Range</b>	<b>AWG</b>	<b>mm<sup>2</sup></b>
Wire Contacts with Bushings	1/0 to 300 mcm	53.5 to 152
<b>Max. Wire Insulation Diameter</b>	<b>in.</b>	<b>mm</b>
	1.100	27.900
<b>Operating Temperature<sup>2</sup></b>	<b>°F</b>	<b>°C</b>
Standard	-4° to 221°	-20° to 105°
Chemical Resistant	-40 to 221°	-40° to 105°
<b>Mating Cycles No Load by Plating</b>	<b>Silver (Ag)</b>	
Wire and Busbar Contacts	10,000	
<b>Avg. Mating / Unmating Force</b>	<b>Lbf.</b>	<b>N</b>
2 Pole	30	133
<b>Min. Contact / Spring Retention Force</b>		
lbf	150	
N	667	

### Protection

#### Touch Safety with Wire Contacts

IEC 60529	IP10
-----------	------

<sup>1</sup> Based on: 105°C rated or better cable of the largest size, Properly calibrated APP® recommended tooling, and a 25°C ambient temperature. UL rating not to exceed the maximum operating temperature. CSA rating below a 30°C temperature rise.

<sup>2</sup> Limited by the thermal properties of the connector plastic housing.

<sup>3</sup> Use APP® recommended tooling only. Alternate tools may adversely affect the performance of our connectors along with UL and CSA recognition.



# | SB® 350 CONNECTOR TEMPERATURE CHARTS |

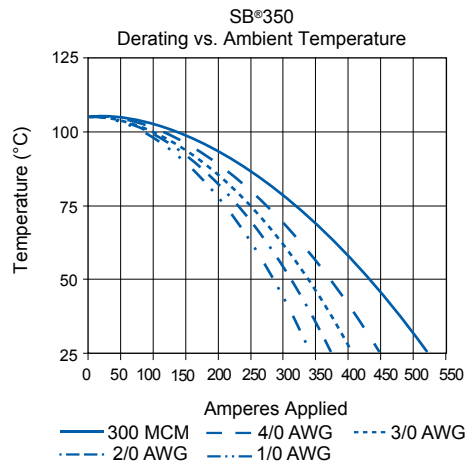
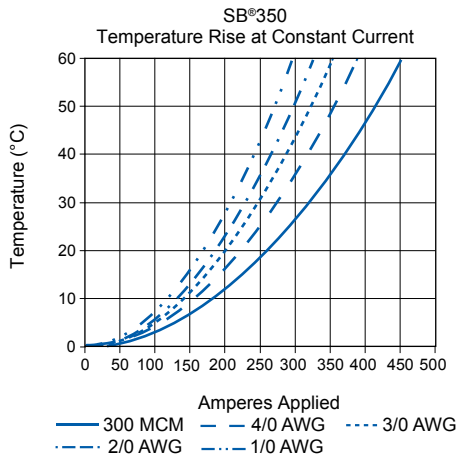

NOTE: Temperature rise charts are based on a 25°C ambient temperature.

## | SB® 350 Accessories |

### Cable Clamps

Durable metal cable clamps securely hold cables to prevent accidental strain or pulls from dislodging wire or contacts from the housing. Cable clamps are recommended for solder terminated wires.

Description	Cable Size		- Part Number -
	Min / Max Inches O.D.	Min / Max mm O.D.	
Minimum Quantity .....			10 .....
Bolt On for Discrete Conductor	1.00 to 0.35	25.4 to 8.8	996G1
Discrete Conductor w/ Integral Handle	0.76 to 0.32	19.3 to 8.2	911

The given wire O.D. information is an estimate. Cable clamps should be evaluated for performance with the actual wire to be used.

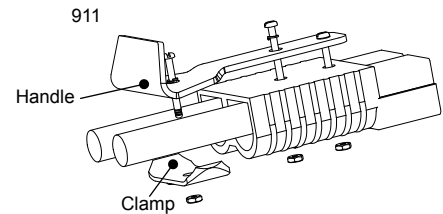

### Handles

Handles are made out of durable PC plastic. Hardware to attach to connector body included in kits.

Description	----- Part Numbers -----	
Minimum Quantity ....	100	25 ...
Gray Handle Kit	995G2-APP	995G2
Red Handle Kit	995G4-APP	995G4
Handle Only, Gray	3-5074P1	-
Handle Only, Red	3-5074P3	-
Handle Only, Black	3-5074P5	-
Hardware Bag	-	106G7

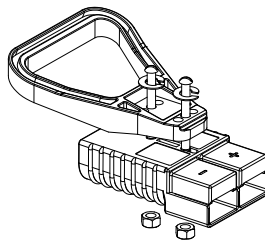

### Dust Cover

Prevents dust and dirt from entering the mating interface of the connector when unmated. NOTE: Not a Hermetic Seal.

Description	----- Part Numbers -----	
Minimum Quantity .....	500	50 ...
Dust Cover with Lanyard Strap, Red	113890P3	134G3

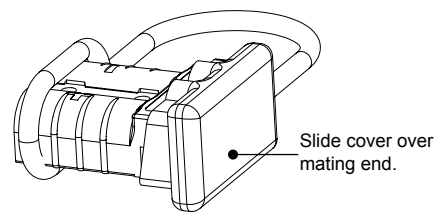

SECTION 3  
SB® 350

## SB®350 Lockout

Works with standard lockout - tagout equipment to prevent access to the mating interface of the connector. Made from durable PC plastic.

Description	----- Part Numbers -----	
Minimum Quantity .....	50	25 .....
Red Lockout - Tagout Kit	GA-350	SB350-LOCKOUT



## Manual Release Bracket - Mounting Side

Works with the Locking Side to ease mating and unmating connectors.

Description	----- Part Numbers -----		
Minimum Quantity .....	66	25	10 ...
Bracket and Hardware Kit	-	-	922G1
Bracket Only	B00229P1	-	-
Hardware Bag	-	106G6	-

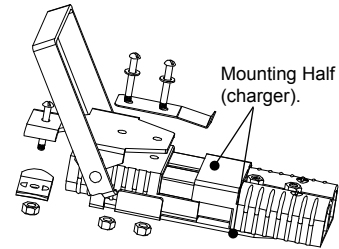

## Manual Release Bracket - Locking Side with Cable Clamp

Works with the Mounting Side to ease mating and unmating connectors.

Description	Cable Size		- Part Numbers -
	Min / Max Inches O.D.	Min / Max mm O.D.	
Minimum Quantity .....			10 .....
Bracket and Hardware Kit w/ Clamp Kit	0.94 to 0.61	23.7 to 15.5	919

The given wire O.D. information is an estimate. Cable clamps should be evaluated for performance with the actual wire to be used.



## Manual Release Bracket - Locking Side no Cable Clamp

Works with the Battery side to ease mating and unmating connectors.

Description	- Part Numbers -
Minimum Quantity .....	10 .....
Bracket and Hardware Kit No Clamp Kit	919G1



## Reducing Bushings: for Use with Contact # 907

Use with contact part number 907-BK to allow a smaller wire to be used with the connector. Electrical capability is derated with smaller wire.

Contact Barrel Size	Wire Size	--- Part Numbers ---	
Minimum Quantity .....		500	100 ...
2/0 AWG [67.4 mm²]	1/0 AWG [53.5 mm²]	5918-BK	5918



# SB®

## - Tooling Information

Wire Size		Loose Piece Part Numbers	Loose Piece Contact Crimp Tools				Reeled Part Numbers	Reeled Contact Crimp Tools			
AWG	mm²		Hand Tool or	Pneumatic Bench Tool	+ Die	+ Locator	Number of Crimps	Tin Plating	ATS Applicator	ATS Press	Air Feed Kit
<b>SB50</b>											
#6	13.3	1307 5900	1309G4	1387G1	1388G6	1389G6	Single	265G5	1385523-1	2-565435-2	692655-1
#8	8.4	5952			1388G7						
#10 / 12	5.3 / 3.3	5953 5915									
<b>SB120</b>											
#1	42.4	1323G1	1368	1387G1	1388G3	1389G4	Single	N/A	N/A		
#2	33.6	1319			1388G4						
#4	21.2	1319G4									
#6	13.3	1319G6									
<b>SB175</b>											
1/0	53.5	1382	1368	1387G2	1303G13	1304G32	Double	N/A	N/A		
#1	42.4	1347		1387G1	1388G3	1389G3	Single				
#2	33.6	1383		1387G2	1303G13	1304G32	Double				
#4	21.1	1384		1387G1	1388G3	1389G3	Single				
				1387G2	1303G13	1304G32	Double				
#6	13.3	1348		1387G1	1388G4	1389G3	Single				
<b>SB350</b>											
300mcm	152	910	1368	N/A			Single	N/A	N/A		
4/0	107.2	908		1387G2	1303G3	1304G31	Double				
3/0	85	916			1303G12						
2/0	67.4	907									
1/0	53.5	917									

NOTE: See website for the most current information.



Компания «ЭлектроПласт» предлагает заключение долгосрочных отношений при поставках импортных электронных компонентов на взаимовыгодных условиях!

Наши преимущества:

- Оперативные поставки широкого спектра электронных компонентов отечественного и импортного производства напрямую от производителей и с крупнейших мировых складов;
- Поставка более 17-ти миллионов наименований электронных компонентов;
- Поставка сложных, дефицитных, либо снятых с производства позиций;
- Оперативные сроки поставки под заказ (от 5 рабочих дней);
- Экспресс доставка в любую точку России;
- Техническая поддержка проекта, помощь в подборе аналогов, поставка прототипов;
- Система менеджмента качества сертифицирована по Международному стандарту ISO 9001;
- Лицензия ФСБ на осуществление работ с использованием сведений, составляющих государственную тайну;
- Поставка специализированных компонентов (Xilinx, Altera, Analog Devices, Intersil, Interpoint, Microsemi, Aeroflex, Peregrine, Syfer, Eurofarad, Texas Instrument, Miteq, Cobham, E2V, MA-COM, Hittite, Mini-Circuits, General Dynamics и др.);

Помимо этого, одним из направлений компании «ЭлектроПласт» является направление «Источники питания». Мы предлагаем Вам помощь Конструкторского отдела:

- Подбор оптимального решения, техническое обоснование при выборе компонента;
- Подбор аналогов;
- Консультации по применению компонента;
- Поставка образцов и прототипов;
- Техническая поддержка проекта;
- Защита от снятия компонента с производства.



#### Как с нами связаться

**Телефон:** 8 (812) 309 58 32 (многоканальный)

**Факс:** 8 (812) 320-02-42

**Электронная почта:** [org@eplast1.ru](mailto:org@eplast1.ru)

**Адрес:** 198099, г. Санкт-Петербург, ул. Калинина, дом 2, корпус 4, литера А.