

Stepper motor driver mounting the L6474

Data brief

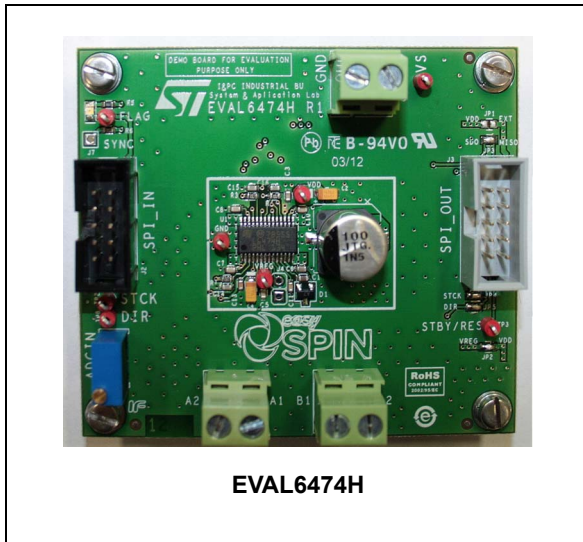

Description

The EVAL6474H demonstration board is a microstepping motor driver. In combination with the STEVAL-PCC009V2 communication board and the SPIN evaluation software, the board allows the user to investigate all the features of the L6474 device.

The EVAL6474H supports the daisy chain configuration making it suitable for the evaluation of the L6474 in multi motor applications.

Features

- Voltage range from 8 V to 45 V
- Phase current up to 3 A_{rms}
- SPI with daisy chain feature
- Socket for external resonator or crystal
- FLAG LED indicator
- Suitable for use in combination with the STEVAL-PCC009V2

Board description

Table 1. EVAL6474H specifications

Parameter	Value
Supply voltage (VS)	8 to 45 V
Maximum output current (each phase)	3 A _{rms}
Logic supply voltage (VREG)	Externally supplied: 3.3 V internally supplied: 3 V typical
Logic interface voltage (VDD)	Externally supplied: 3.3 V or 5 V internally supplied: VREG
Low level logic input voltage	0 V
High level logic input voltage	VDD ⁽¹⁾
Operating temperature	-25 to +125 °C
L6474H thermal resistance junction to ambient	21 °C/W typical

1. All logic inputs are 5 V tolerant.

Figure 1. Jumper and connector location

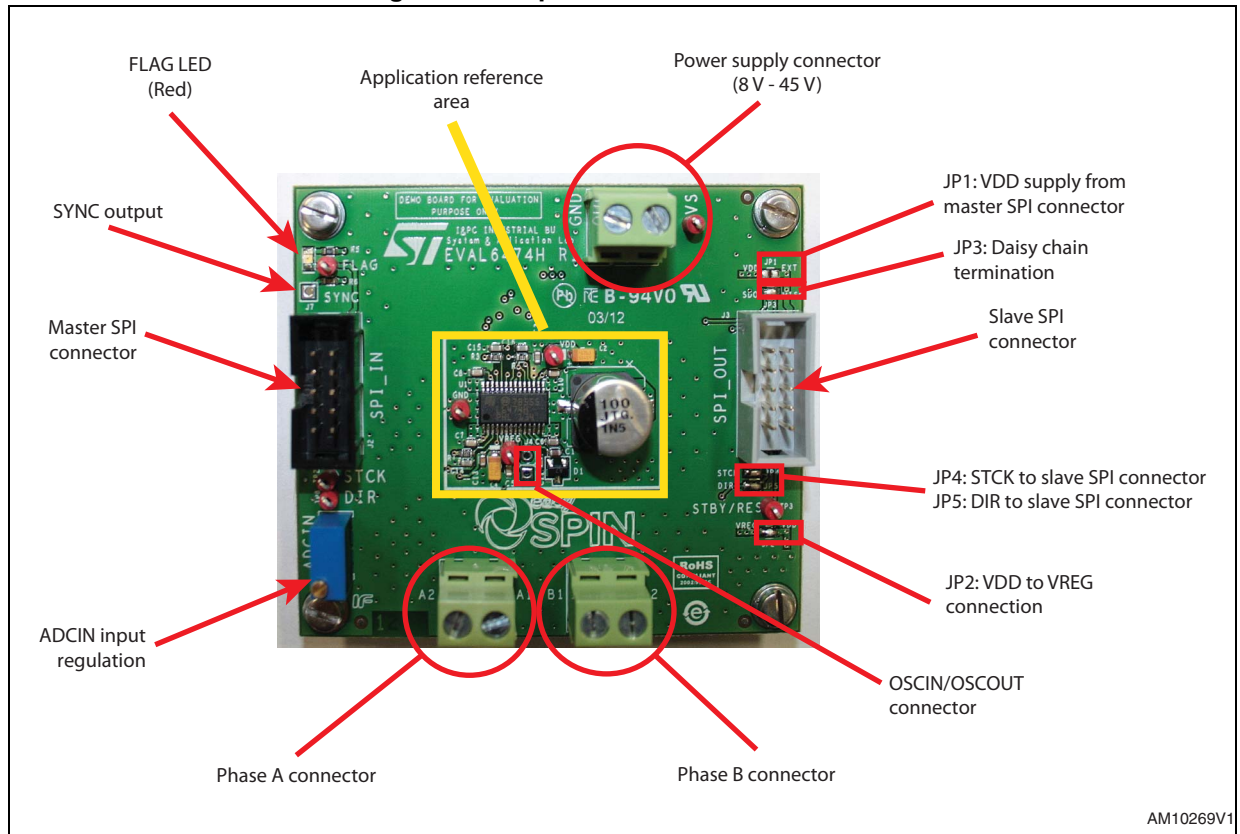

AM10269V1

Table 2. Jumpers and connectors description

Name	Type	Function
J1	Power supply	Motor supply voltage
J5	Power output	Bridge A outputs
J6	Power output	Bridge B outputs
J2	SPI connector	Master SPI
J3	SPI connector	Slave SPI
J4	NM connector	OSCIN and OSCOUT pins
J7	NM connector	SYNC output
TP1 (VS)	Test point	Motor supply voltage test point
TP4 (VDD)	Test point	Logic interface supply voltage test point
TP5 (VREG)	Test point	Logic supply voltage/L6474 internal regulator test point
TP6 (GND)	Test point	Ground test point
TP2 (STCK)	Test point	Step clock input test point
TP8 (DIR)	Test point	DIR output test point
TP3 (STBY/RES)	Test point	STBY/RES input test point
TP7 (FLAG)	Test point	FLAG output test point

Table 3. Slave SPI connector pinout (J11)

Pin number	Type	Description
1	Digital input	L6474 direction input
2	Open drain output	L6474 FLAG output
3	Ground	Ground
4	Supply	EXT_VDD (can be used as external logic power supply)
5	Digital output	SPI "Master In Slave Out" signal (connected to the L6474 SDO output through daisy chain termination jumper JP2)
6	Digital input	SPI serial clock signal (connected to L6474 CK input)
7	Digital input	SPI "Master Out Slave In" signal (connected to the L6474 SDI input)
8	Digital input	SPI slave select signal (connected to the L6474 CS input)
9	Digital input	L6474 step-clock input
10	Digital input	L6474 standby/reset input

Figure 2. EVAL6474H schematic

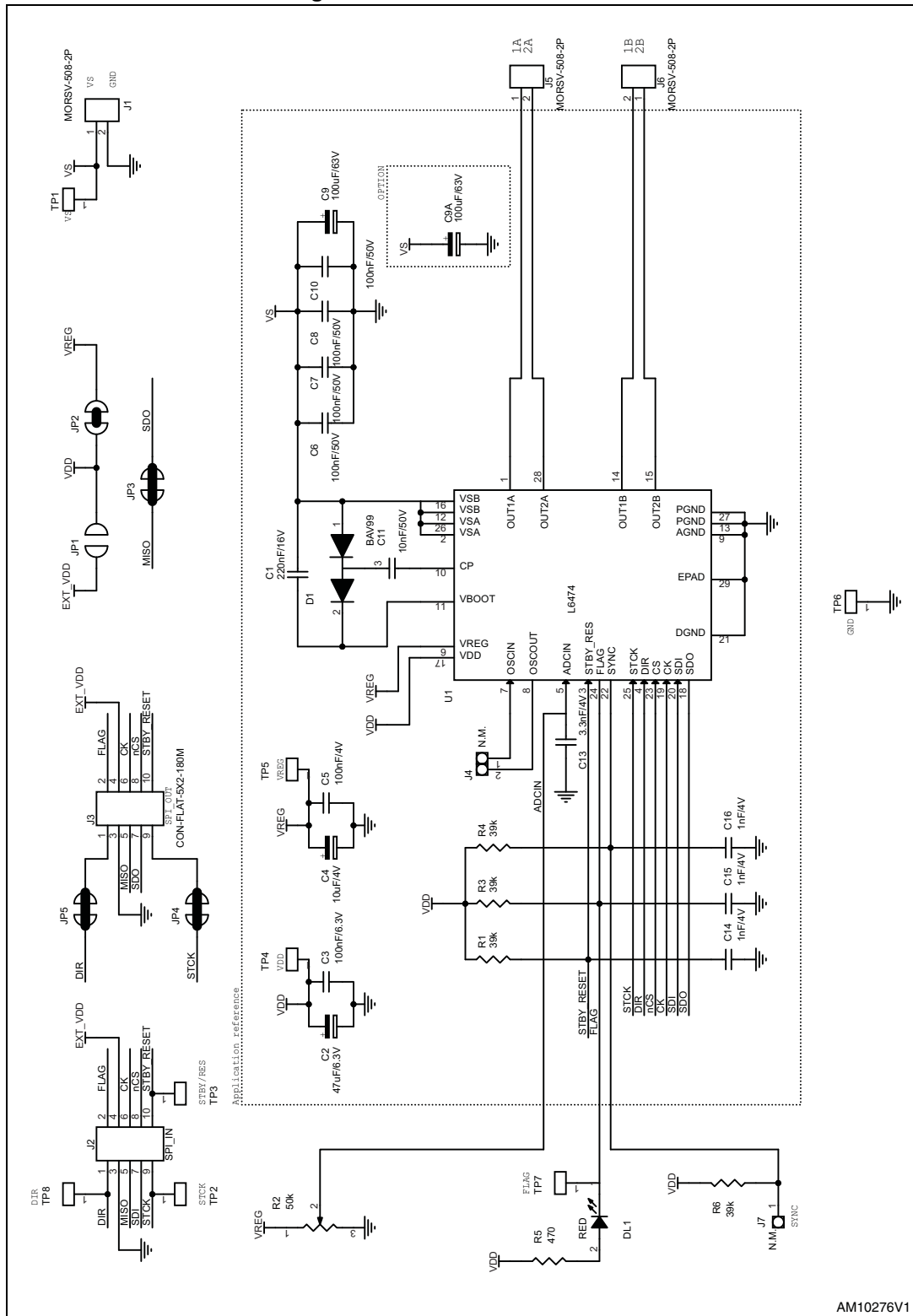

AM10276V1

Table 4. Bill of material

Item	Quantity	Reference	Value	Package
1	1	C1	220 nF/16 V	CAPC-0603
2	1	C2	47 μ F/6.3 V	CAPC-3216
3	1	C3	100 nF/6.3 V	CAPC-0603
4	1	C4	10 μ F/4 V	CAPC-3216
5	1	C5	100 nF/4 V	CAPC-0603
6	4	C6, C7, C8, C10	100 nF/50 V	CAPC-0603
7	1	C9A	100 μ F/63 V	CAPE-R8H12-P35
8	1	C9	100 μ F/63 V	CAPE-R10HXX
9	1	C11	10 nF/50 V	CAPC-0603
10	1	C13	3.3 nF/4 V	CAPC-0603
11	3	C14, C15, C16	1 nF/4 V	CAPC-0603
12	1	DL1	LED diode (red)	LEDC-0805
13	1	D1	BAV99	SOT-23
14	1	JP1	Jumper - open	JP2SO
15	4	JP2, JP3, JP4, JP5	Jumper - closed	JP2SO
16	3	J1, J5, J 6	Screw connector 2 poles	MORSV-508-2P
17	2	J2, J3	Pol. IDC male header vertical 10 poles	CON-FLAT-5 x 2 - 180 M
18	1	J4	N.M.	STRIP254P-M-2
19	1	J7	N.M.	TPTH-44SQ70
20	4	R1, R3, R4, R6	39 k Ω	RESC-0603
21	1	R2	50 k Ω	TRIMM-100 x 50 x 110 - 64 W
22	1	R5	470 Ω	RESC-0603
23	8	TP1, TP2, TP3, TP4, TP5, TP6, TP7, TP8	Test point	TH
24	1	U1	L6474H	HTSSOP28

Figure 3. EVAL6474H - layout (top layer)

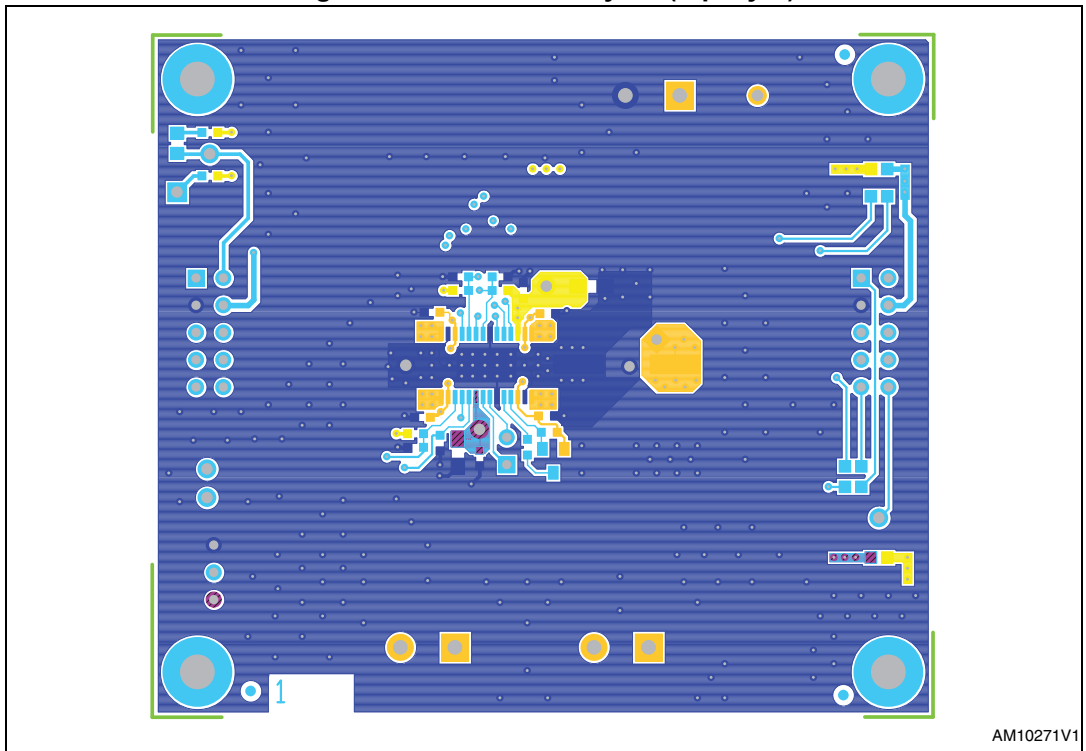

Figure 4. EVAL6474H - layout (inner layer 2)

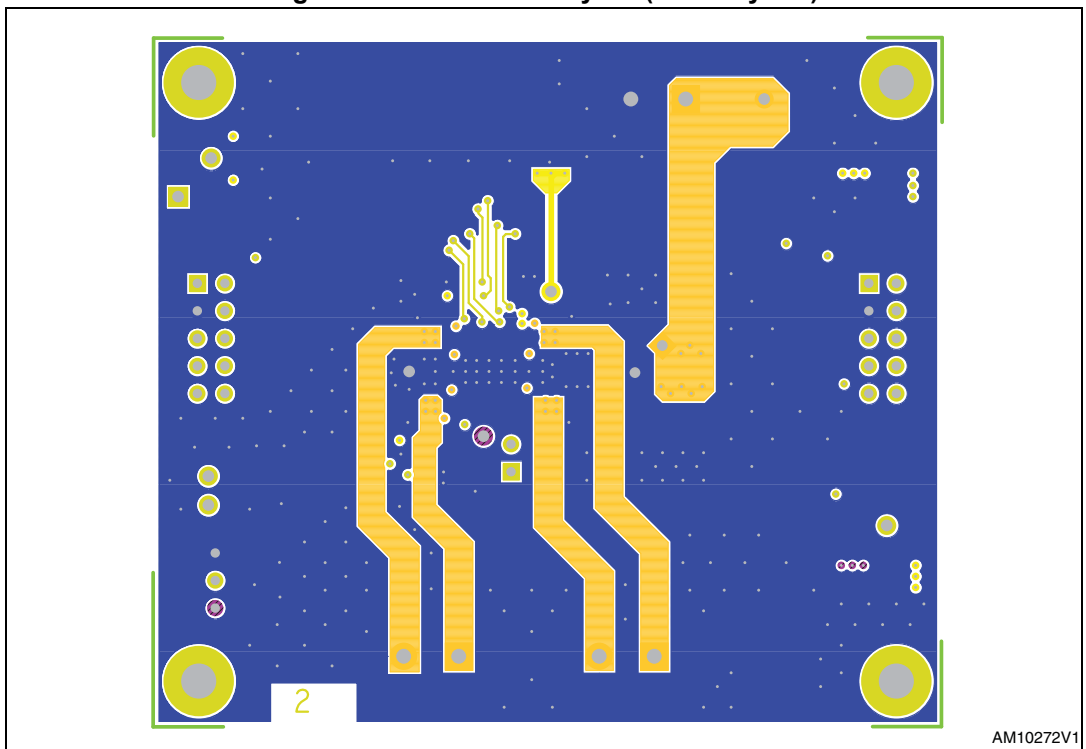

Figure 5. EVAL6474H - layout (inner layer 3)

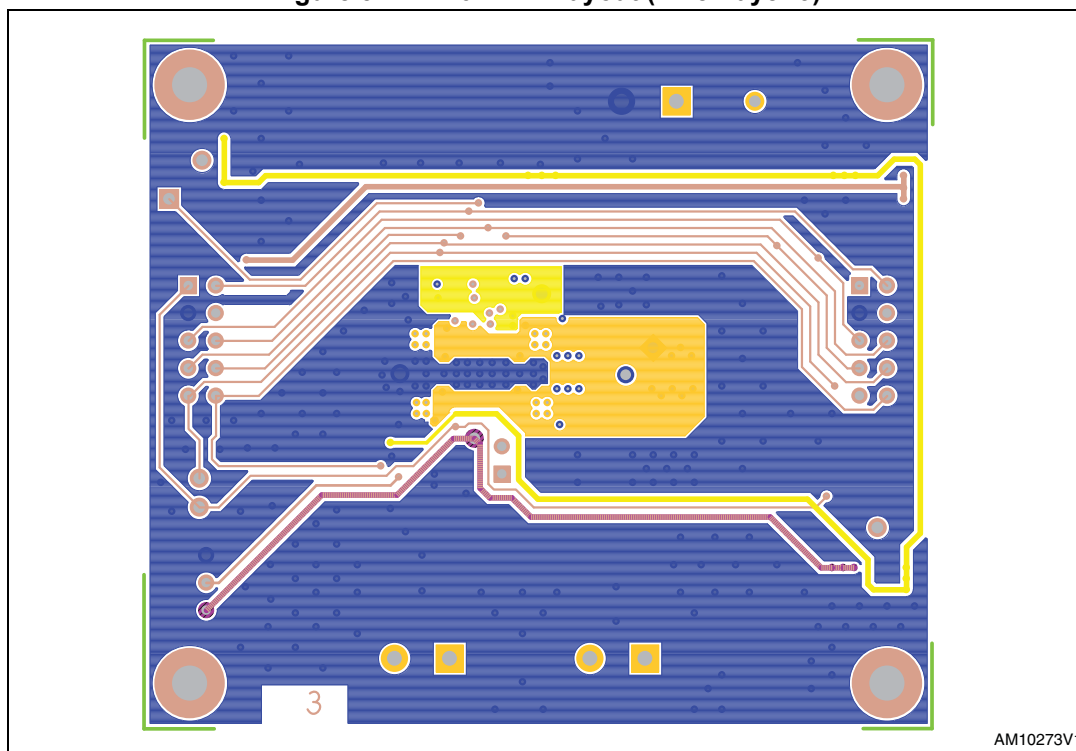
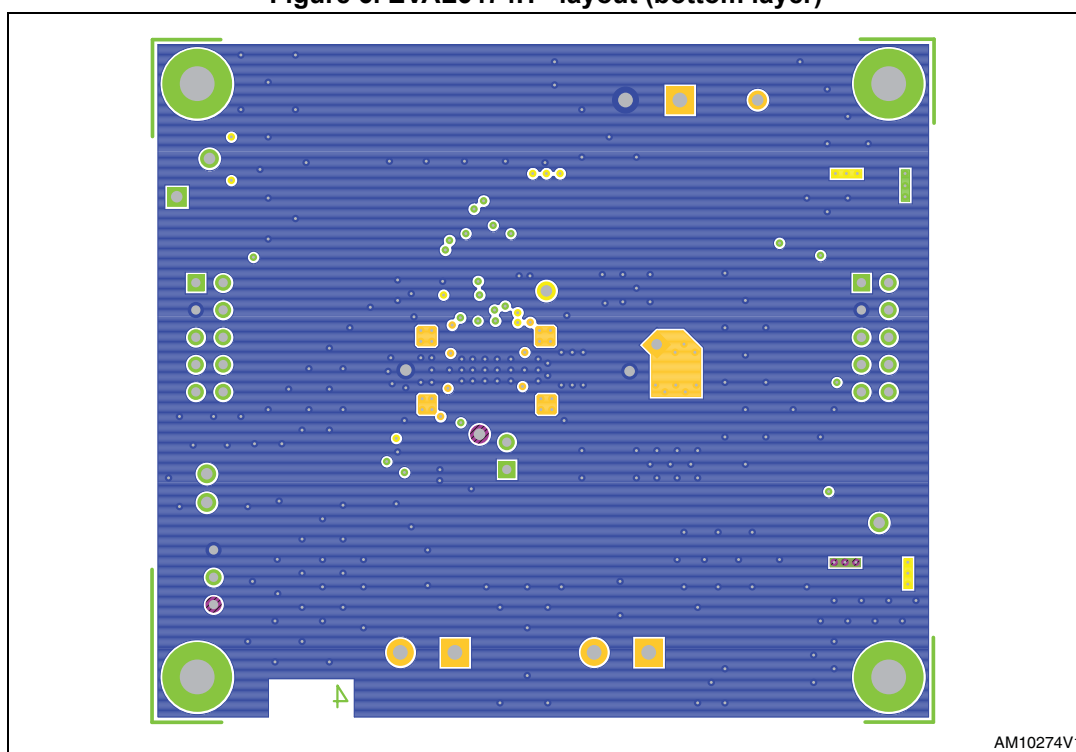
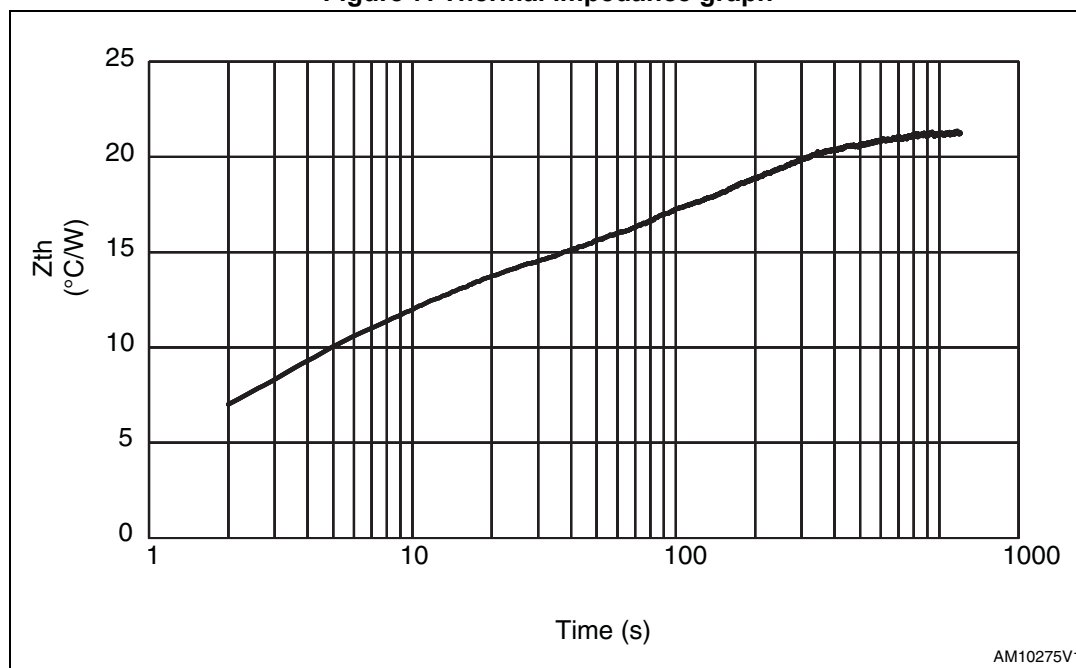

Figure 6. EVAL6474H - layout (bottom layer)



Thermal data

Figure 7. Thermal impedance graph



Revision history

Table 5. Document revision history

Date	Revision	Changes
02-Feb-2012	1	Initial release.
18-Mar-2015	2	Replaced easySPIN by SPIN in Section : Description on page 1 . Removed Figure 3. EVAL6474H - layout (silk screen) from page 6. Minor modifications throughout document.

IMPORTANT NOTICE – PLEASE READ CAREFULLY

STMicroelectronics NV and its subsidiaries ("ST") reserve the right to make changes, corrections, enhancements, modifications, and improvements to ST products and/or to this document at any time without notice. Purchasers should obtain the latest relevant information on ST products before placing orders. ST products are sold pursuant to ST's terms and conditions of sale in place at the time of order acknowledgement.

Purchasers are solely responsible for the choice, selection, and use of ST products and ST assumes no liability for application assistance or the design of Purchasers' products.

No license, express or implied, to any intellectual property right is granted by ST herein.

Resale of ST products with provisions different from the information set forth herein shall void any warranty granted by ST for such product.

ST and the ST logo are trademarks of ST. All other product or service names are the property of their respective owners.

Information in this document supersedes and replaces information previously supplied in any prior versions of this document.

© 2015 STMicroelectronics – All rights reserved



Компания «ЭлектроПласт» предлагает заключение долгосрочных отношений при поставках импортных электронных компонентов на взаимовыгодных условиях!

Наши преимущества:

- Оперативные поставки широкого спектра электронных компонентов отечественного и импортного производства напрямую от производителей и с крупнейших мировых складов;
- Поставка более 17-ти миллионов наименований электронных компонентов;
- Поставка сложных, дефицитных, либо снятых с производства позиций;
- Оперативные сроки поставки под заказ (от 5 рабочих дней);
- Экспресс доставка в любую точку России;
- Техническая поддержка проекта, помощь в подборе аналогов, поставка прототипов;
- Система менеджмента качества сертифицирована по Международному стандарту ISO 9001;
- Лицензия ФСБ на осуществление работ с использованием сведений, составляющих государственную тайну;
- Поставка специализированных компонентов (Xilinx, Altera, Analog Devices, Intersil, Interpoint, Microsemi, Aeroflex, Peregrine, Syfer, Eurofarad, Texas Instrument, Miteq, Cobham, E2V, MA-COM, Hittite, Mini-Circuits, General Dynamics и др.);

Помимо этого, одним из направлений компании «ЭлектроПласт» является направление «Источники питания». Мы предлагаем Вам помощь Конструкторского отдела:

- Подбор оптимального решения, техническое обоснование при выборе компонента;
- Подбор аналогов;
- Консультации по применению компонента;
- Поставка образцов и прототипов;
- Техническая поддержка проекта;
- Защита от снятия компонента с производства.



Как с нами связаться

Телефон: 8 (812) 309 58 32 (многоканальный)

Факс: 8 (812) 320-02-42

Электронная почта: org@eplast1.ru

Адрес: 198099, г. Санкт-Петербург, ул. Калинина, дом 2, корпус 4, литера А.