



**TV-8 rated.
1 Form A 5A power relays**

LK-T RELAYS



RoHS compliant

Protective construction: Flux-resistant type

FEATURES

- High inrush current capability**
 - Operating load capability: inrush 118 A, steady 8 A
 - UL/C-UL TV-8 approved
- Long insulation distance**
 - Creepage distance and clearances between contact and coil: Min. 6 mm .236 inch (In compliance with IEC60065)
 - Surge withstand voltage between contact and coil: 10,000 V or more
- Conforms to the various safety standards**
UL/C-UL, TÜV, and SEMKO approved

TYPICAL APPLICATIONS

- Audio visual equipment
- Flat TVs and audio equipment, etc.
- Office equipment
- Home appliances

ORDERING INFORMATION

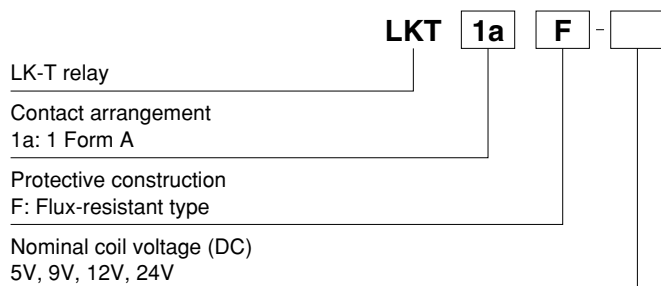

Notes: Certified by UL/C-UL, TÜV and SEMKO

TYPES

Contact arrangement	Nominal coil voltage	Part No.
1 Form A	5V DC	LKT1aF-5V
	9V DC	LKT1aF-9V
	12V DC	LKT1aF-12V
	24V DC	LKT1aF-24V

Standard packing Carton: 100 pcs. Case: 500 pcs.

Note: 3 V, 6 V and 18 V DC types are also available. Please consult us for details.

RATING

1. Coil data

Nominal coil voltage	Pick-up voltage (at 20°C 68°F)	Drop-out voltage (at 20°C 68°F)	Nominal operating current [±10%] (at 20°C 68°F)	Coil resistance [±10%] (at 20°C 68°F)	Nominal operating power	Max. applied voltage (at 20°C 68°F)
5V DC	70%V or less of nominal voltage (Initial)	10%V or more of nominal voltage (Initial)	50.0mA	100Ω	250mW	6.5V DC
9V DC			27.8mA	324Ω		11.7V DC
12V DC			20.8mA	576Ω		15.6V DC
24V DC			10.4mA	2,304Ω		31.2V DC

2. Specifications

Characteristics	Item	Specifications	
Contact	Arrangement	1 Form A	
	Contact resistance (Initial)	Max. 100 mΩ (By voltage drop 6 V DC 1A)	
	Contact material	AgSnO ₂ type	
Rating	Nominal switching capacity (resistive load)	5A 277V AC	
	Max. switching power (resistive load)	1,385VA	
	Max. switching voltage	277V AC	
	Max. switching current	8A (AC)	
	Min. switching capacity (reference value)*1	100mA, 5V DC	
Electrical characteristics	Insulation resistance (Initial)	Min. 1,000MΩ (at 500V DC) Measurement at same location as "Breakdown voltage" section.	
	Breakdown voltage (Initial)	Between open contacts	1,000 Vrms for 1 min. (Detection current: 10 mA)
		Between contact and coil	4,000 Vrms for 1 min. (Detection current: 10 mA)
	Surge breakdown voltage*2 (Between contact and coil) (Initial)	10,000 V	
	Operate time (at nominal voltage) (at 20°C 68°F) (Initial)	Max. 15 ms (excluding contact bounce time.)	
Release time (at nominal voltage) (at 20°C 68°F) (Initial)	Max. 5 ms (excluding contact bounce time) (Without diode)		
Mechanical characteristics	Shock resistance	Functional	200 m/s ² (Half-wave pulse of sine wave: 11 ms; detection time: 10μs.)
		Destructive	1,000 m/s ² (Half-wave pulse of sine wave: 6 ms.)
	Vibration resistance	Functional	10 to 55 Hz at double amplitude of 1.5 mm (Detection time: 10μs.)
		Destructive	10 to 55 Hz at double amplitude of 1.5 mm
Expected life	Mechanical (at 180 times/min.)	Min. 10 ⁶	
	Electrical (at 20 times/min.)	Min. 10 ⁵ (ON: 1.5s, OFF: 1.5s, at nominal switching capacity)	
Conditions	Conditions for operation, transport and storage*3	Ambient temperature: -40°C to +70°C -40°F to +158°F, Humidity: 5 to 85% R.H. (Not freezing and condensing at low temperature), Air pressure: 86 to 106kPa	
	Max. operating speed	20 times/min. (at nominal switching capacity)	
Unit weight		Approx. 12 g .42 oz	

Notes: *1. This value can change due to the switching frequency, environmental conditions, and desired reliability level, therefore it is recommended to check this with the actual load.

*2. Wave is standard shock voltage of ±1.2×50μs according to JEC-212-1981

*3. The upper limit of the ambient temperature is the maximum temperature that can satisfy the coil temperature rise value. Refer to Usage, transport and storage conditions in NOTES.

REFERENCE DATA

1. Max. switching power (AC resistive load)

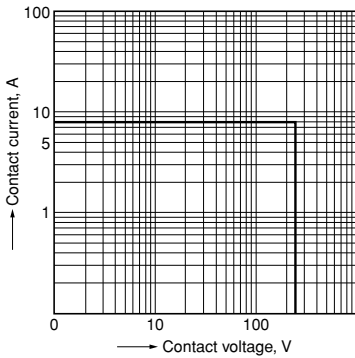

2. Coil temperature rise

Sample: LKT1aF-12V, 6 pcs.
Point measured: coil inside
Contact current: 0 A, 8A

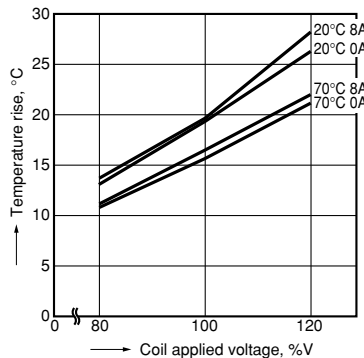

3. Ambient temperature characteristics and coil applied voltage

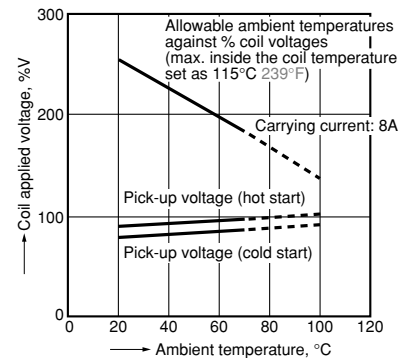

4-(1). Electrical life test (5 A 277 V AC, resistive load)

Sample: LKT1aF-12V, 6 pcs.
Operation frequency: 20 times/min.
(ON/OFF = 1.5s: 1.5s)
Ambient temperature: 20°C 68°F

Circuit:

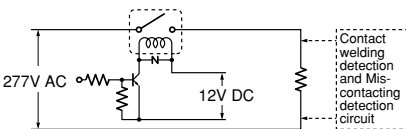

Change of pick-up and drop-out voltage

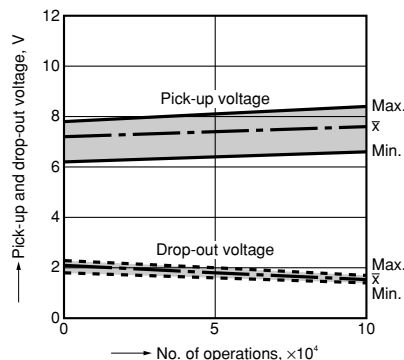

Change of contact resistance

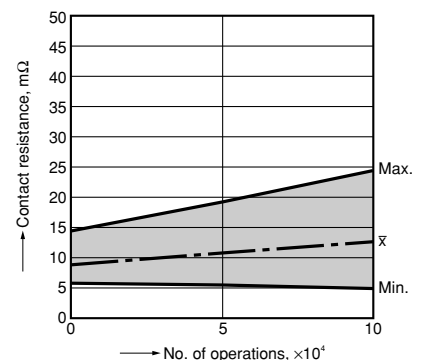

4-(2). Electrical life test

(UL508 TV-8 rating test)

Sample: LKT1aF-12V, 6 pcs.

• Overload test

Load: 12 A 120 V AC (60 Hz),
Inductive load (cosφ = 0.75)
Operation frequency: 6 times/min
(ON : OFF = 1 s : 9 s)
No. of operations: 50 ope.

• Endurance test

Load: 8A 120 V AC (960 W lamp load),
(Inrush: 118 A)
Operation frequency: 1 times/min
(ON : OFF = 1 s : 59 s)
No. of operations: 25,000 ope.

Change of pick-up and drop-out voltage

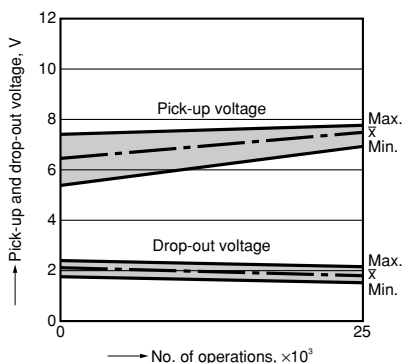

Change of contact resistance

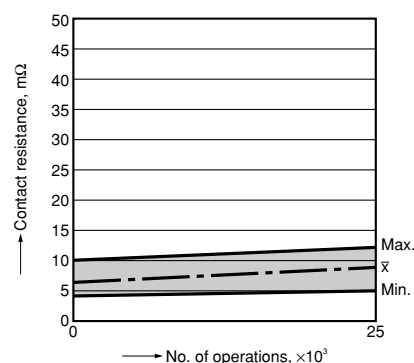

DIMENSIONS (mm inch)

The CAD data of the products with a **CAD Data** mark can be downloaded from: <http://industrial.panasonic.com/ac/e/>

CAD Data

External dimensions

PC board pattern (Bottom view)

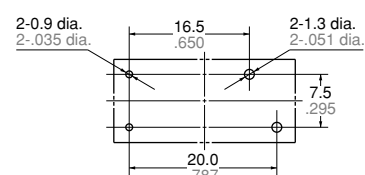
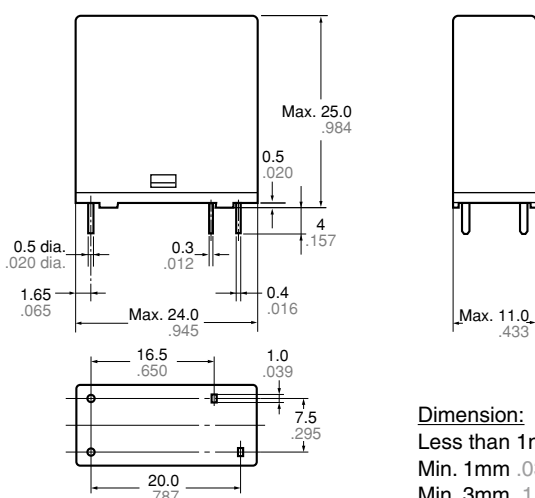

Tolerance: ±0.1 ±.004

Schematic (Bottom view)



Dimension:

Less than 1mm .039inch:
Min. 1mm .039inch less than 3mm .118 inch: ±0.2 ±.008
Min. 3mm .118 inch: ±0.3 ±.012

General tolerance

±0.1 ±.004
±0.2 ±.008
±0.3 ±.012

SAFETY STANDARDS

UL/C-UL (Recognized)			VDE (Certified)			TÜV (Certified)		
File No.	Contact rating	Cycles	File No.	Contact rating	Cycles	File No.	Contact rating	Cycles
E43149	8A 277V AC General use	5 × 10 ⁴	40014390	8A 250V AC (cosφ=1.0)	2 × 10 ⁴	B 12 09 13461 333	8A 250V AC (cosφ=1.0)	2 × 10 ⁴
	5A 277V AC General use	10 ⁵		—	—		—	—
	5A 30V DC Resistive	10 ⁵		—	—		—	—
SEMKO (Certified)			TV Rating (UL/C-UL)					
File No.	Contact rating		File No.	Contact rating				
1408509	3/100A 250V AC		E43149	TV-8				
	5/40A 250V AC			—				

* CSA standard: Certified by C-UL

**EN/IEC VDE Certified
INSULATION CHARACTERISTIC(IEC61810-1)**

Item	Characteristic
Clearance/Creepage distance (IEC61810-1)	Min. 5.5mm/5.5mm
Category of protection (IEC61810-1)	RT II
Tracking resistance (IEC60112)	PTI 175
Insulation material group	III a
Over voltage category	III
Rated voltage	250V
Pollution degree	2
Type of insulation (Between contact and coil)	Reinforced insulation
Type of insulation (Between open contacts)	Micro disconnection

NOTES

1. For cautions for use, please read
“GENERAL APPLICATION
GUIDELINES”.

Please contact

Panasonic Corporation

Electromechanical Control Business Division

■ 1006, Oaza Kadoma, Kadoma-shi, Osaka 571-8506, Japan
industrial.panasonic.com/ac/e/

Panasonic[®]

©Panasonic Corporation 2016

Mouser Electronics

Authorized Distributor

Click to View Pricing, Inventory, Delivery & Lifecycle Information:

Panasonic:

[LKT1AF-24V](#) [LKT1AF-5V](#) [LKT1AF-9V](#)



Компания «ЭлектроПласт» предлагает заключение долгосрочных отношений при поставках импортных электронных компонентов на взаимовыгодных условиях!

Наши преимущества:

- Оперативные поставки широкого спектра электронных компонентов отечественного и импортного производства напрямую от производителей и с крупнейших мировых складов;
- Поставка более 17-ти миллионов наименований электронных компонентов;
- Поставка сложных, дефицитных, либо снятых с производства позиций;
- Оперативные сроки поставки под заказ (от 5 рабочих дней);
- Экспресс доставка в любую точку России;
- Техническая поддержка проекта, помощь в подборе аналогов, поставка прототипов;
- Система менеджмента качества сертифицирована по Международному стандарту ISO 9001;
- Лицензия ФСБ на осуществление работ с использованием сведений, составляющих государственную тайну;
- Поставка специализированных компонентов (Xilinx, Altera, Analog Devices, Intersil, Interpoint, Microsemi, Aeroflex, Peregrine, Syfer, Eurofarad, Texas Instrument, Miteq, Cobham, E2V, MA-COM, Hittite, Mini-Circuits, General Dynamics и др.);

Помимо этого, одним из направлений компании «ЭлектроПласт» является направление «Источники питания». Мы предлагаем Вам помощь Конструкторского отдела:

- Подбор оптимального решения, техническое обоснование при выборе компонента;
- Подбор аналогов;
- Консультации по применению компонента;
- Поставка образцов и прототипов;
- Техническая поддержка проекта;
- Защита от снятия компонента с производства.



Как с нами связаться

Телефон: 8 (812) 309 58 32 (многоканальный)

Факс: 8 (812) 320-02-42

Электронная почта: org@eplast1.ru

Адрес: 198099, г. Санкт-Петербург, ул. Калинина, дом 2, корпус 4, литера А.