

LCFE Series

RoHS



Pinout

0605mm Size

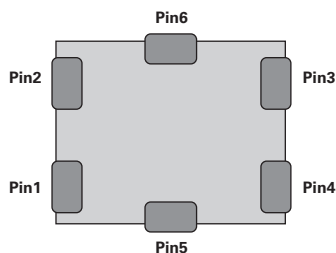

Item	Description	Source	Equipment
R _{dc}	Pin 1-4, 2-3	10mA DC Source	Source Meter
CM Impedance	Pin 1-2(Short) to Pin 3-4(Short)	500mV	LCR Meter (3GHz)
IL	Pin 5 or 6 to Pin 1,2,3,4	5V DC Source	Source Meter
I _{R_{CR}}	Pin 1-2 or Pin 3-4	5V DC Source	Source Meter

0806mm Size

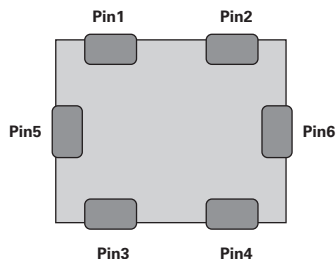

Item	Description	Source	Equipment
R _{dc}	Pin 1-3, 2-4	10mA DC Source	Source Meter
CM Impedance	Pin 1-2(Short) to Pin 3-4(Short)	500mV	LCR Meter (3GHz)
IL	Pin 5 or 6 to Pin 1,2,3,4	5V DC Source	Source Meter
I _{R_{CR}}	Pin 1-2 or Pin 3-4	5V DC Source	Source Meter

Description

This specification covers the engineering requirements for both Common Mode Noise Filter (CMF) and ESD Protection, especially high speed differential serial interfaces, such as USB 3.1, USB 3.0, MIPI D-PHY or HDMI.

Features

- Effective for suppressing common mode noise and almost no effect for high speed differential data line
- Differential mode cut-off frequency up to 10.5GHz at -3dB
- One common mode filters and two ESD suppression devices integrated
- Ultra low profile as low as 0.68x0.55x0.35mm
- Ceramic multilayer type SMD component
- Non-polarized product
- Conforming to RoHS directive
- ±15kV air, ±8kV contact ESD protection (IEC 61000-4-2 Level 4)
- High temperature soldering guaranteed: 260°C/10 seconds

Applications

- Mobile Phone and Tablet
- USB 3.1 Gen 1 and 2 (5 and 10Gbps) with Type C
- Display Port 1.2 (5.4Gbps)
- HDMI 2.0 (6.0Gbps)
- MDDI, MIPI, MHL
- Portable/Wearable Devices
- Game console, POS, VR, Dongle
- Consumer Products
- PDP, LCD TV, DVD Player, PC, Audio player, DSC, Set top box, Laptop, SSD, Home Automation, IoT module

1210mm Size

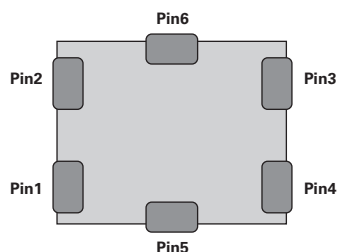

Item	Description	Source	Equipment
R _{dc}	Pin 1-4, 2-3	10mA DC Source	Source Meter
CM Impedance	Pin 1-2(Short) to Pin 3-4(Short)	500mV	LCR Meter (3GHz)
IL	Pin 5 or 6 to Pin 1,2,3,4	5V DC Source	Source Meter
I _{R_{CR}}	Pin 1-2 or Pin 3-4	5V DC Source	Source Meter

1608mm Size

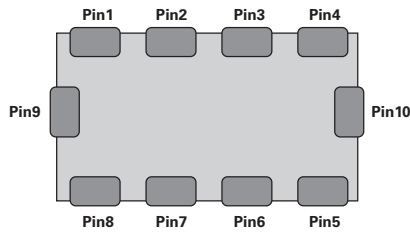

Item	Description	Source	Equipment
Rdc	Pin 1-8, 2-7, 3-6, 4-5	10mA DC Source	Source Meter
CM Impedance	Pin 1-2(Short) to Pin 8-7(Short) Pin 3-4(Short) to Pin 6-5(Short)	500mV	LCR Meter (3GHz)
IL	Pin 9 or 10 to Pin 1~4 or 5~8	5V DC Source	Source Meter

2012mm Size (LCFE201202A900TG, LCFE201202A121TG)

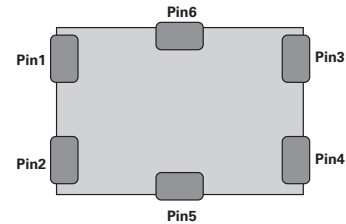

Item	Description	Source	Equipment
Rdc	Pin 1-3, 2-4	10mA DC Source	Source Meter
CM Impedance	Pin 1-2(Short) to Pin 3-4(Short)	500mV	LCR Meter (3GHz)
IL	Pin 5 or 6 to Pin 1,2,3,4	5V DC Source	Source Meter
IR _{CR}	Pin 1-2 or Pin 3-4	5V DC Source	Source Meter

3008mm Size

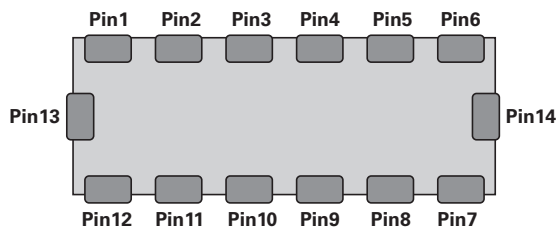

Item	Description	Source	Equipment
Rdc	Pin 1-12, 2-11, 3-10, 4-9, 5-8, 6-7	10mA DC Source	Source Meter
CM Impedance	Pin 1-2(Short) to Pin 12-11(Short) Pin 3-4(Short) to Pin 10-9(Short) Pin 5-6(Short) to Pin 8-7(Short)	500mV	LCR Meter (3GHz)
IL	Pin 13 or 14 to Pin 1~6 or 7~12	5V DC Source	Source Meter

2012mm Size (LCFE201204A101TG)

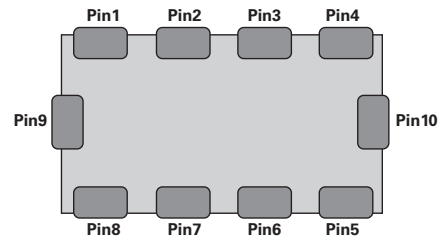

Item	Description	Source	Equipment
Rdc	Pin 1-8, 2-7, 3-6, 4-5	10mA DC Source	Source Meter
CM Impedance	Pin 1-2(Short) to Pin 8-7(Short) Pin 3-4(Short) to Pin 6-5(Short)	500mV	LCR Meter (3GHz)
IL	Pin 9 or 10 to Pin 1~4 or 5~8	5V DC Source	Source Meter

Functional Block Diagram

LCFE060502A120TG, LCFE060502A350TG, LCFE060502A650TG,
 LCFE121002A120TG, LCFE121002A350TG, LCFE121002A500TG,
 LCFE121002A650TG, LCFE121002A900TG, LCFE121002H900TG

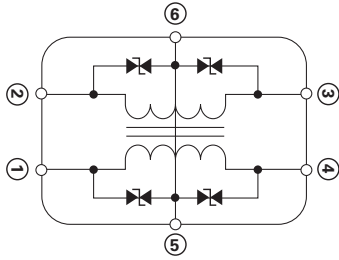

①~④: Data Line; ⑤ and ⑥:Ground

LCFE160804A180TG, LCFE160804A350TG, LCFE160804A550TG,
 LCFE160804A750TG, LCFE160804H101TG, LCFE201204A101TG

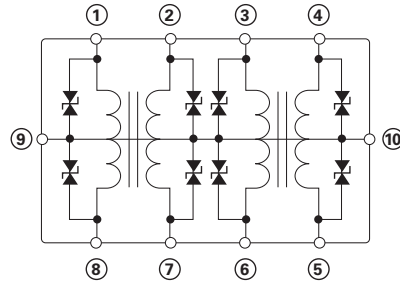

①~⑥: Data Line; ⑨ and ⑩:Ground

LCFE080602A120TG, LCFE080602A250TG, LCFE080602W500TG,
 LCFE080602A750TG, LCFE080602A900TG, LCFE080602H900TG,
 LCFE080602G900TG, LCFE201202A900TG, LCFE201202A121TG

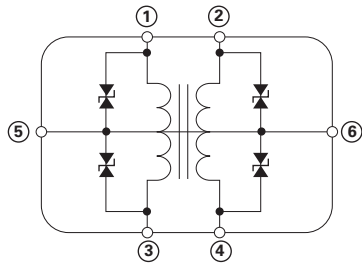

①~④: Data Line; ⑤ and ⑥:Ground

LCFE300806A750TG

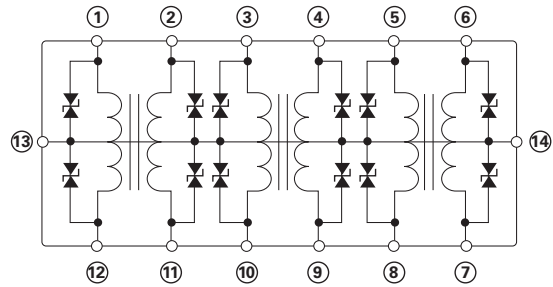

①~⑫: Data Line; ⑬ and ⑭: Ground

Electrical Characteristics

Part Number	Size (mm)	Size (inch)	Common Mode Impedance (Ω)	Rated Current (mA) Max.	Cut-off Freq/ GHz	DC Resistance (Ω) Max.	Number of Lines	Leakage Current (μA) Max.	Capacitance (pF)	Insulation Resistance (MΩ) Min.	Rated Voltage (V)
LCFE060502A120TG	0605	0202	12(±30%)	100	14.1	3.0	2	1.0	1.2	10	5
LCFE060502A350TG	0605	0202	35(±25%)	50	7.09	5.5	2	1.0	1.7	10	5
LCFE060502A650TG	0605	0202	65(±25%)	50	4.76	8.0	2	1.0	1.7	10	5
LCFE080602A120TG	0806	0302	12(±30%)	100	7.38	5.0	2	1.0	1.7	10	5
LCFE080602A250TG	0806	0302	25(±25%)	100	7.97	5.0	2	1.0	1.7	10	5
LCFE080602W500TG	0806	0302	50(±25%)	100	3.60	7.0	2	1.0	1.7	10	5
LCFE080602A750TG	0806	0302	75(±25%)	100	3.80	6.0	2	1.0	1.7	10	5
LCFE080602A900TG	0806	0302	90(±25%)	100	3.80	6.0	2	1.0	1.7	10	5
LCFE080602H900TG	0806	0302	90(±25%)	100	3.74	8.0	2	1.0	2.0	10	5
LCFE080602G900TG	0806	0302	90(±25%)	100	2.82	8.0	2	1.0	2.0	10	5
LCFE121002A120TG	1210	0504	12(±30%)	100	9.02	4.0	2	1.0	1.7	10	5
LCFE121002A350TG	1210	0504	35(±25%)	100	6.38	4.0	2	1.0	1.7	10	5
LCFE121002A500TG	1210	0504	50(±25%)	100	4.96	4.0	2	1.0	1.7	10	5
LCFE121002A650TG	1210	0504	65(±25%)	100	4.30	4.0	2	1.0	1.7	10	5
LCFE121002A900TG	1210	0504	90(±25%)	100	4.57	4.0	2	1.0	1.7	10	5
LCFE121002H900TG	1210	0504	90(±25%)	100	3.90	6.0	2	1.0	1.7	10	5
LCFE160804A180TG	1608	0603	18(±30%)	100	10.35	6.0	4	1.0	1.7	10	5
LCFE160804A350TG	1608	0603	35(±30%)	100	7.20	6.0	4	1.0	1.7	10	5
LCFE160804A550TG	1608	0603	55(±25%)	100	4.09	6.0	4	1.0	2.0	10	5
LCFE160804A750TG	1608	0603	75(±25%)	100	4.91	6.0	4	1.0	1.7	10	5
LCFE160804H101TG	1608	0603	100(±25%)	100	3.96	8.0	4	1.0	2.0	10	5
LCFE201202A900TG	2012	0805	90(±25%)	100	3.38	4.0	2	1.0	1.7	10	5
LCFE201202A121TG	2012	0805	120(±25%)	100	3.62	4.0	2	1.0	1.7	10	5
LCFE201204A101TG	2012	0805	100(±25%)	100	4.22	4.0	4	1.0	1.7	10	5
LCFE300806A750TG	3008	1203	75(±25%)	100	4.51	6.0	6	1.0	2.0	10	5

Test Conditions

- Common Mode Impedance (Ω): @100MHz
- DC Resistance (Ω): 25°C±2°C
- Leakage Current (μA): 5V
- Capacitance (pF) : 0.5Vrms @1MHz
- Insulation Resistance (Max. MΩ): 5V
- Rated Voltage (V): 25°C±2°C
- Rated Current (mA): 25°C±2°C

Impedance Curves - 0605mm Size
Common Mode

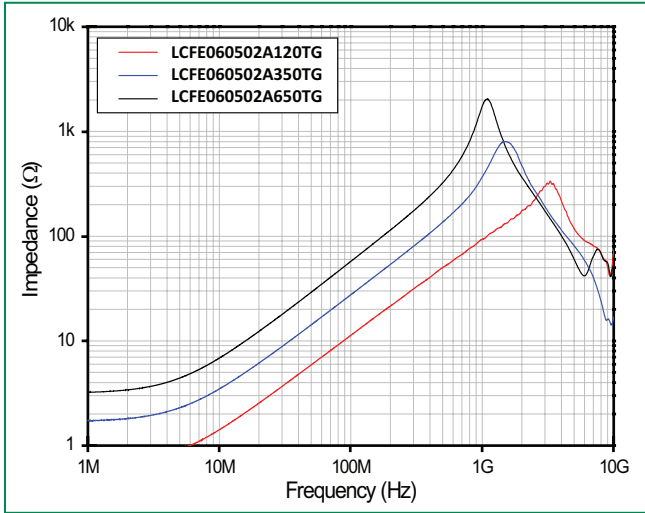

Differential Mode

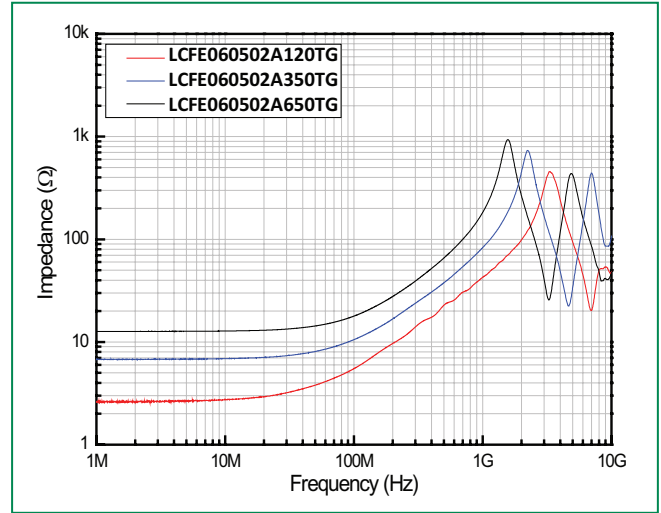

Transmission Characteristics (S-parameter)
Common Mode S21

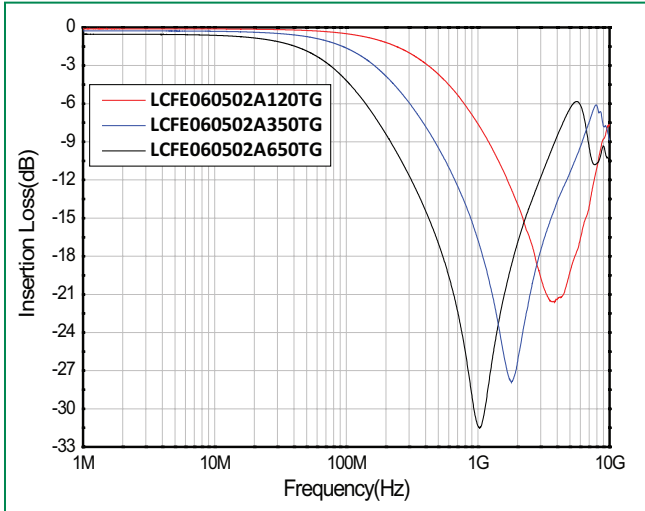

Differential Mode S21

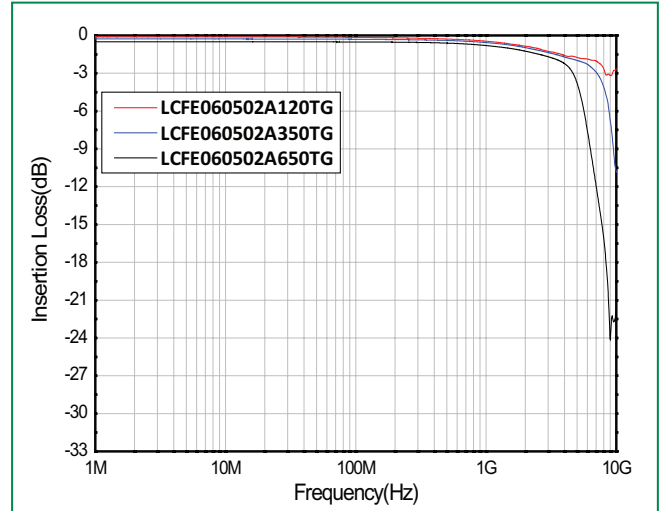

**Impedance Curves - 0806mm Size
Common Mode**

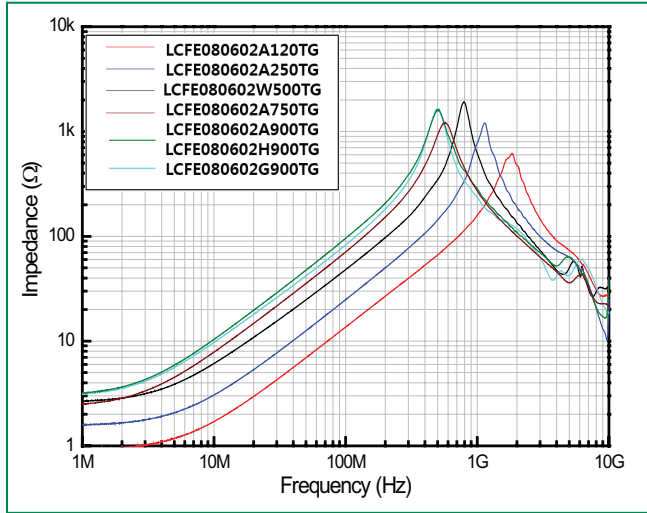

Differential Mode

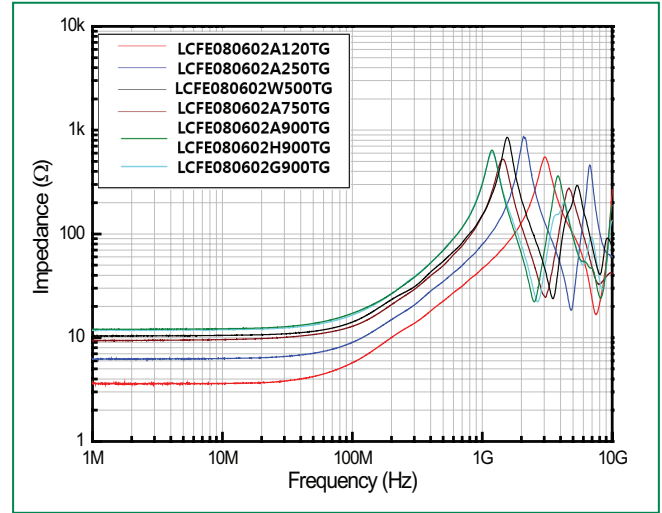

**Transmission Characteristics (S-parameter)
Common Mode S21**

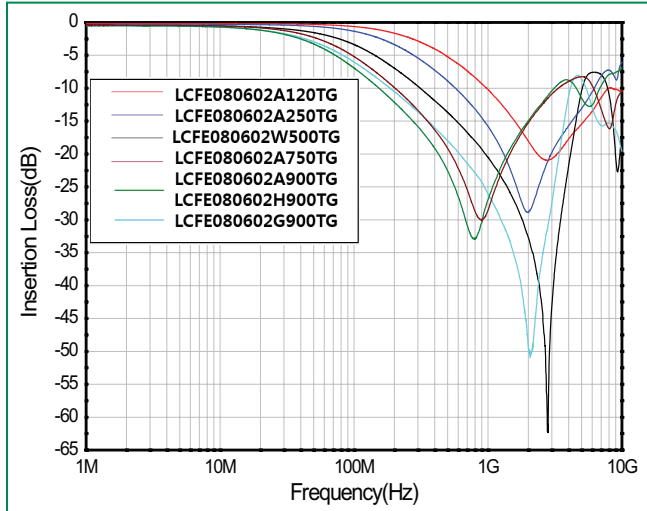

Differential Mode S21

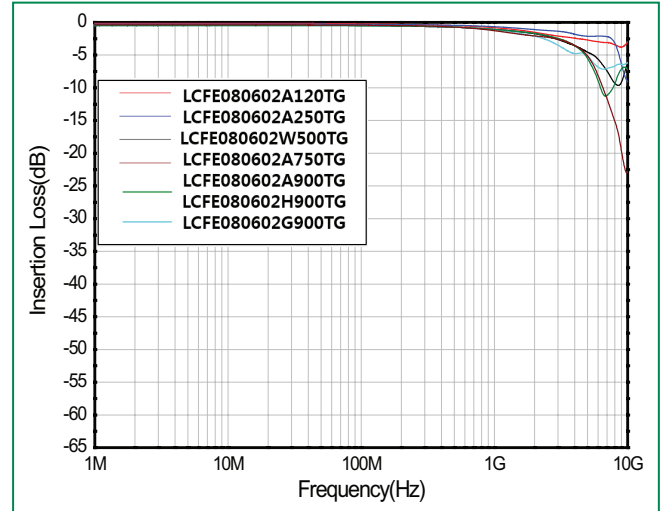

Impedance Curves - 1210mm Size
Common Mode

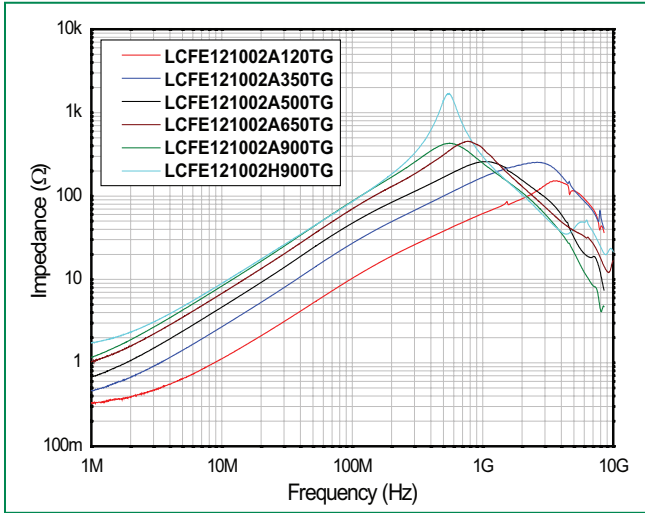

Differential Mode

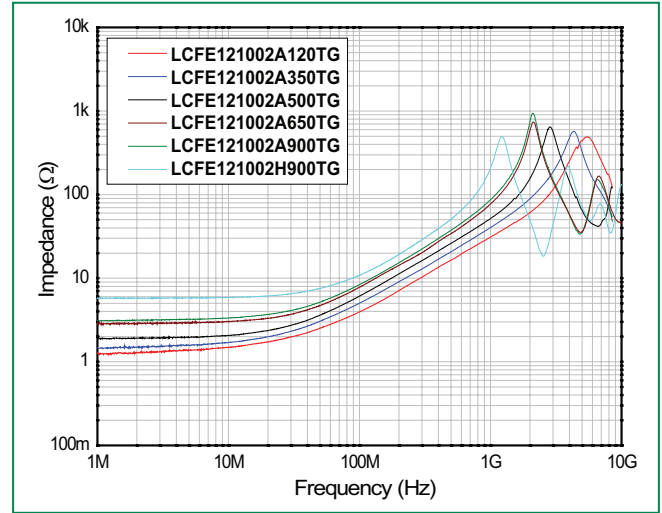

Transmission Characteristics (S-parameter)
Common Mode S21

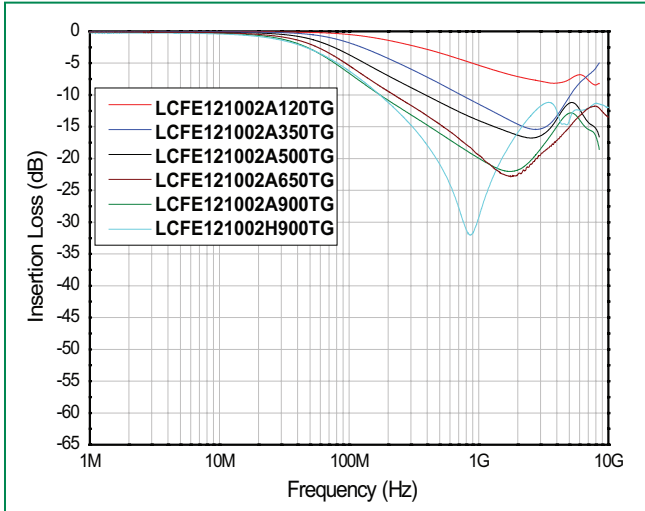

Differential Mode S21

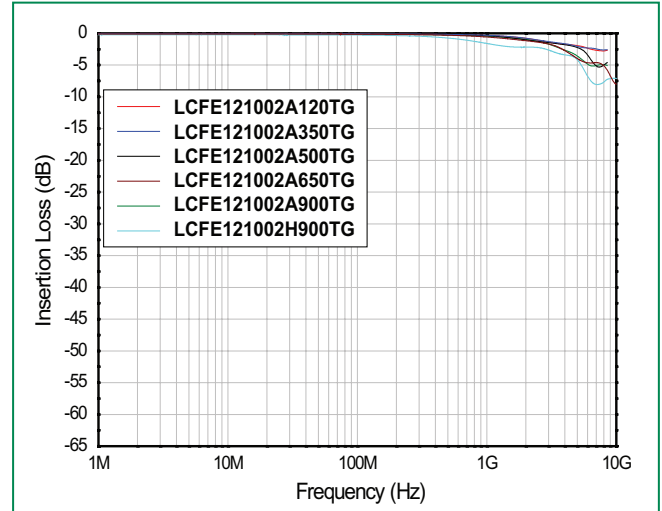

Impedance Curves - 1608mm Size Common Mode

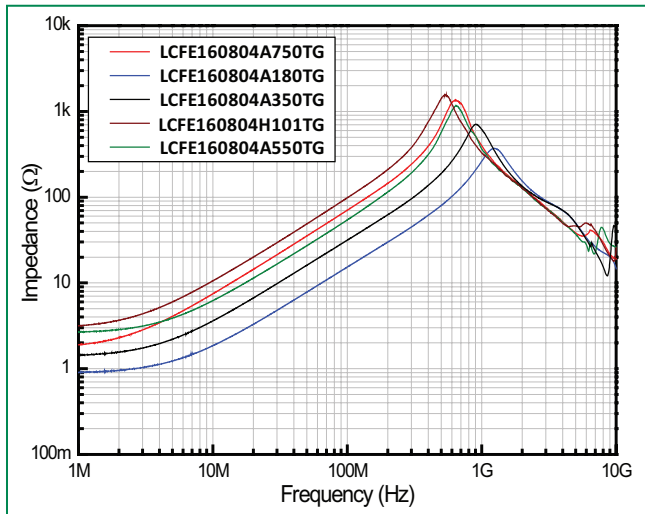

Differential Mode

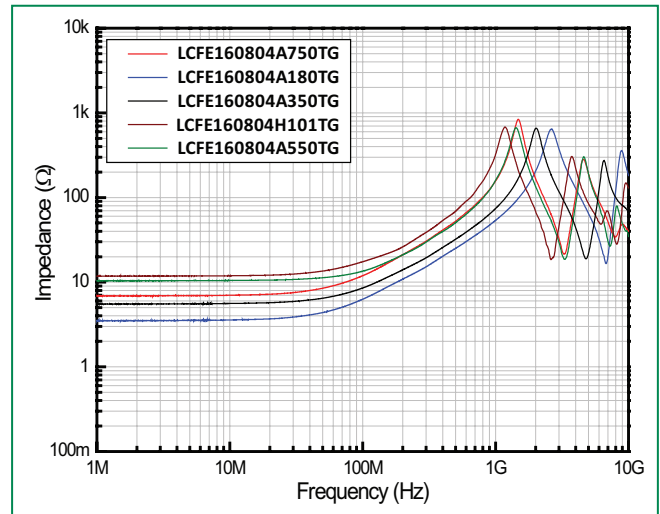

Transmission Characteristics (S-parameter) Common Mode S21

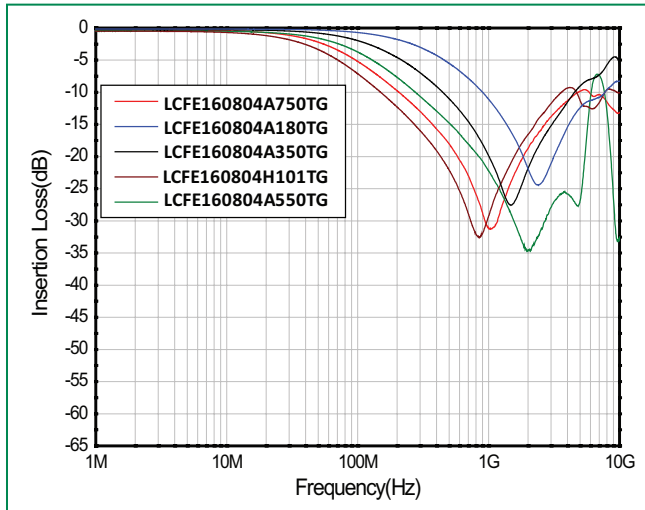

Differential Mode S21

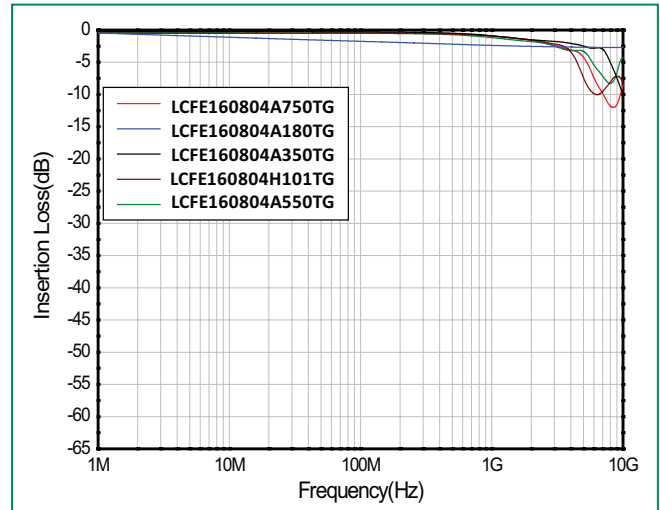

Impedance Curves - 2012mm Size
Common Mode

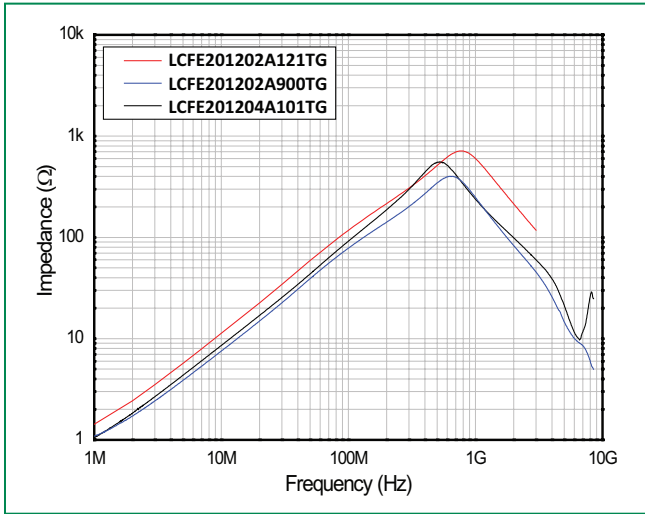

Differential Mode

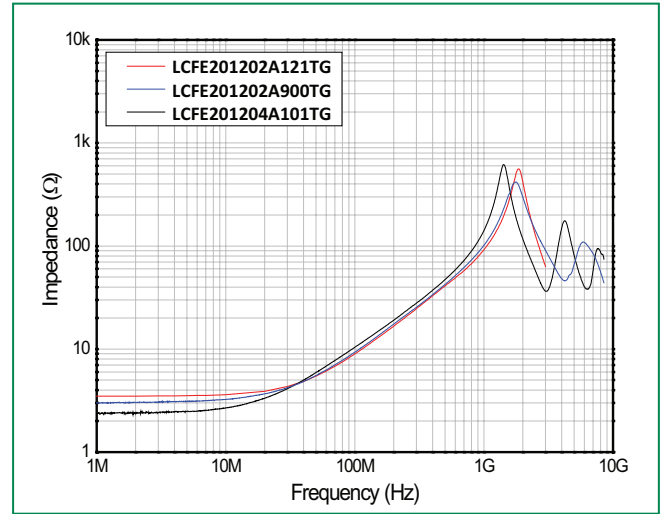

Transmission Characteristics (S-parameter)
Common Mode S21

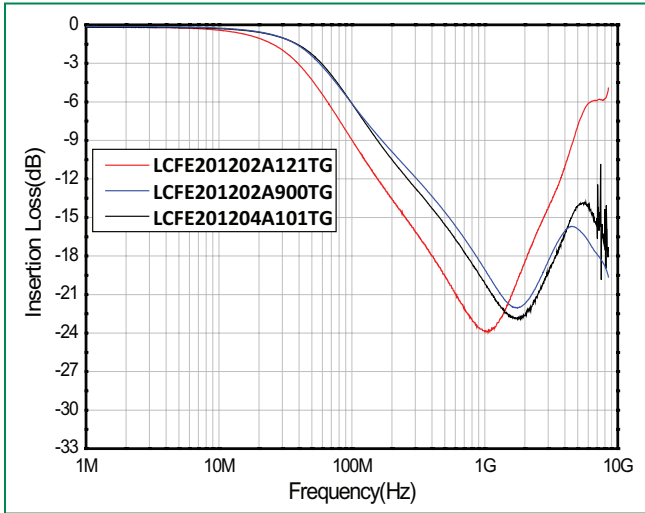

Differential Mode S21

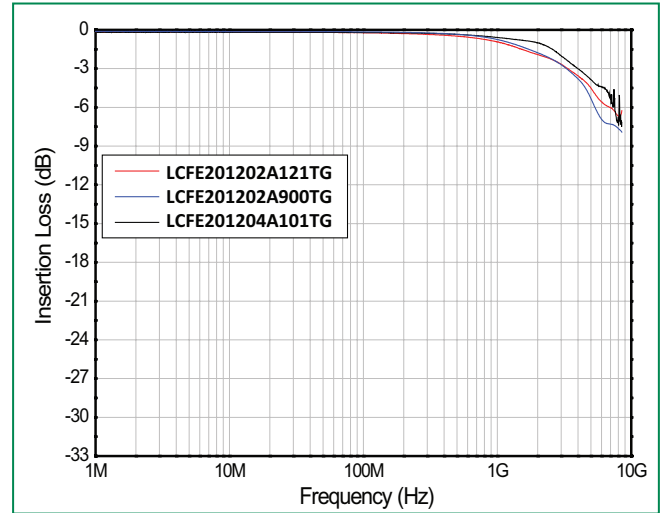

**Impedance Curves - 3008mm Size
Common Mode**

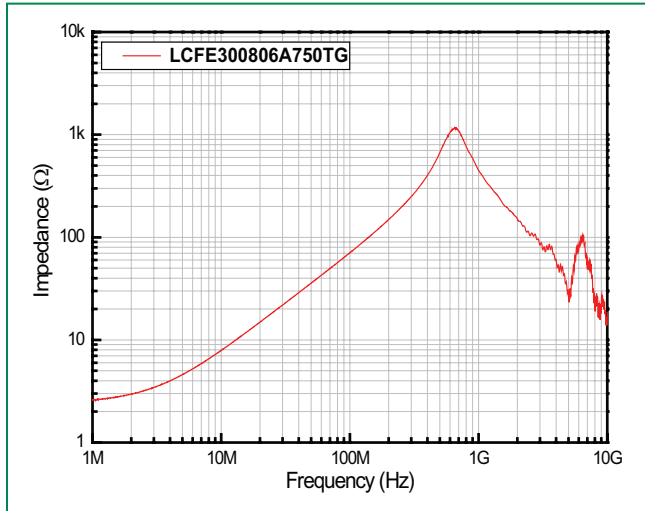

Differential Mode

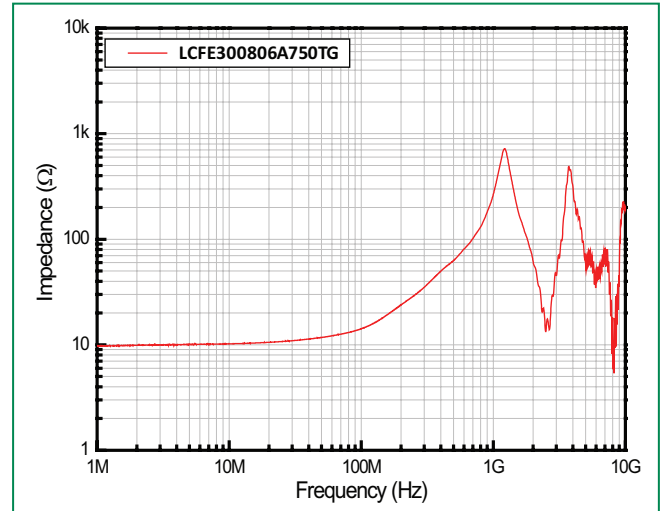

**Transmission Characteristics (S-parameter)
Common Mode S21**

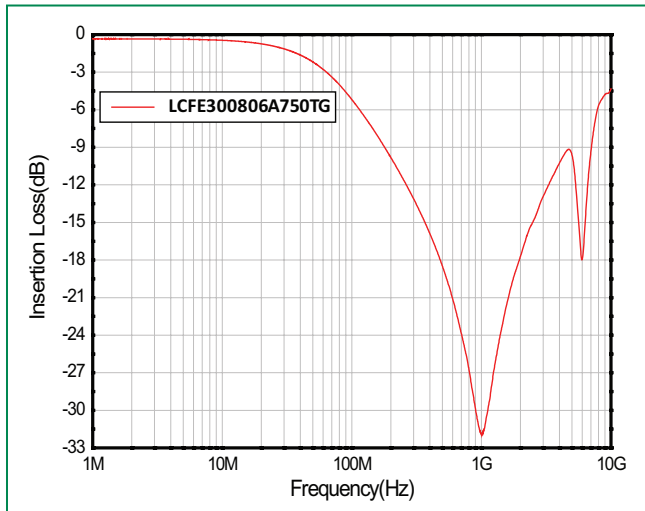

Differential Mode S21

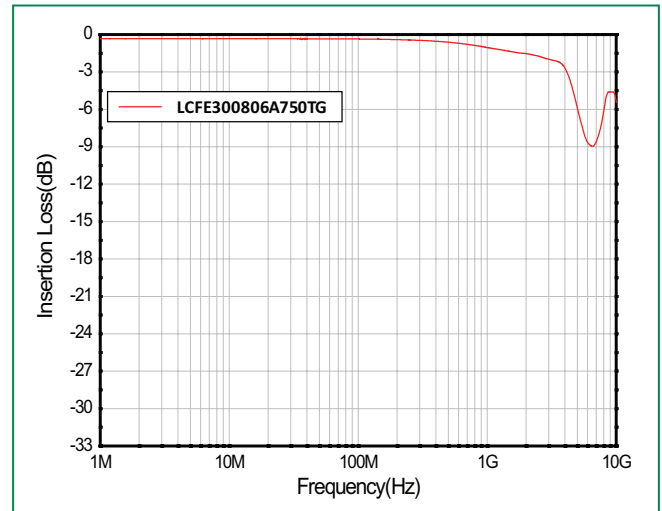

Soldering Parameters

Reflow Condition		Pb-free assembly
Pre Heat	- Temperature Min ($T_{S(min)}$)	160°C
	- Temperature Max ($T_{S(max)}$)	185°C
	- Time (Min to Max) (t_s)	100 – 120 seconds
Average Ramp-up Rate (Liquidus Temp (T_L) to peak)		1°C/second max
$T_{S(max)}$ to T_L - Ramp-up Rate		1°C/second max
Reflow	- Temperature (T_L) (Liquidus)	220°C
	- Temperature (t_L)	30 – 50 seconds
Peak Temperature (T_P)		260°C
Time within 5°C of actual peak Temperature (t_p)		5~10 seconds
Ramp-down Rate		2°C/second max
Time 25°C to Peak Temperature (T_P)		4 minutes max
Do not exceed		260°C
Wave Soldering		260°C, 10 sec. max

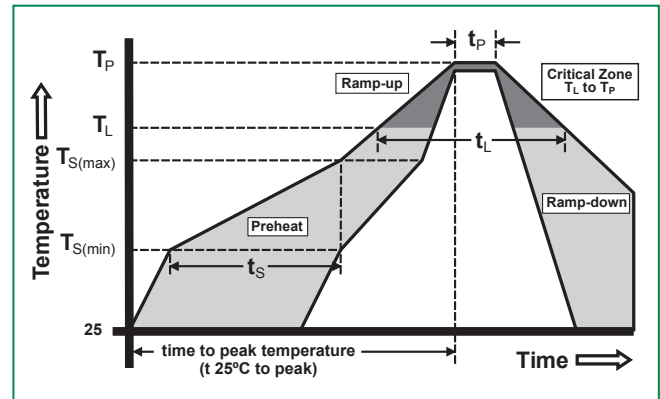

Recommended Soldering Profile (Lead free condition)

Product Characteristics

Lead Pull Strength	5N
Solderability	260°C, ≤10s (Reflow), Max 380°C, ≤5s (Soldering iron)
Soldering Heat Resistance	Max 260°C 10sec(Wave), Max Temperature: Max 380°C (Max 5sec)
Operating Temperature	-40°C to +85°C
Climatic Category	-40°C to +85°C/8 days
Stock Conditions	-10°C + 40°C RH, ≤ 70%
Vibration Resistance	5 g's for 20 minutes, 12 cycles each of 3 orientations

Dimensions

Unit = mm

0605mm Size

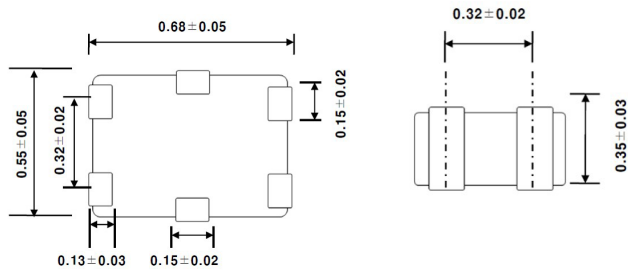

0806mm Size

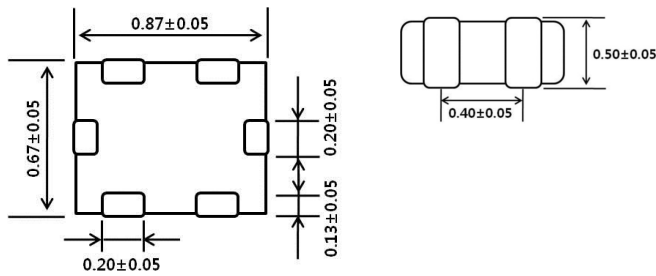

1210mm Size

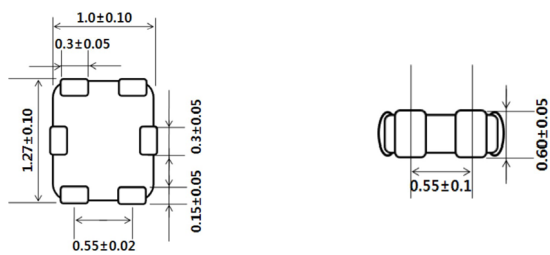

1608mm Size

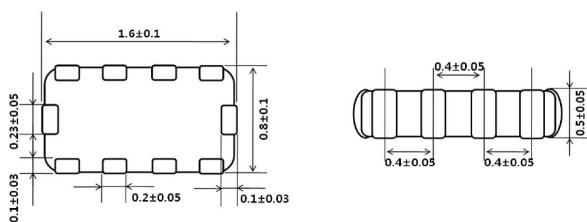

Recommended Footprint and Stencil Mask

Unit = mm

Stencil Mask T = 0.10mm

0605mm Size

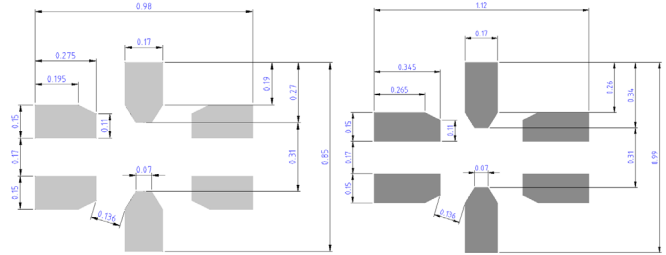

0806mm Size

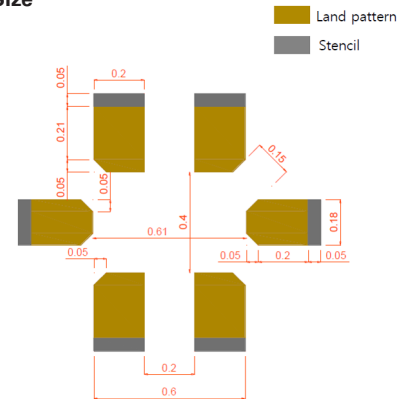

1210mm Size

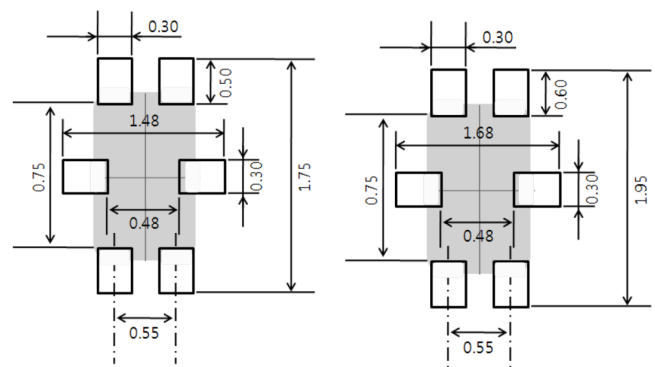

1608mm Size

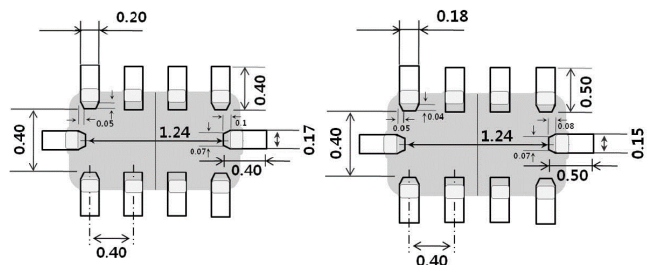

Dimensions

Unit = mm

2012mm Size (LCFE201202A900TG, LCFE201202A121TG)

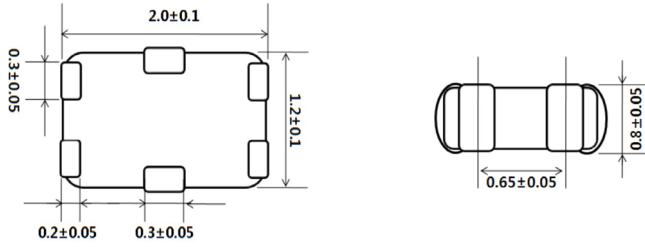

2012mm Size (LCFE201204A101TG)

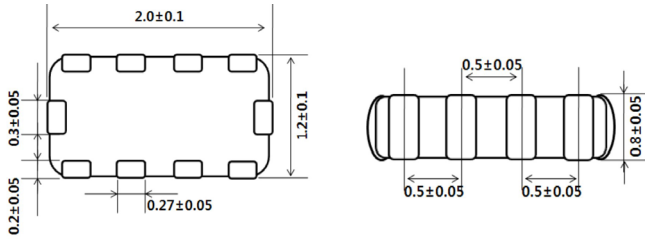

3008mm Size

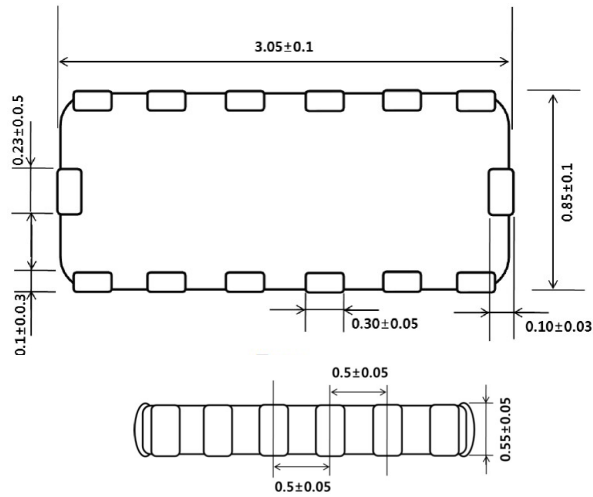

Recommended Footprint and Stencil Mask

Unit = mm

Stencil Mask T = 0.10mm

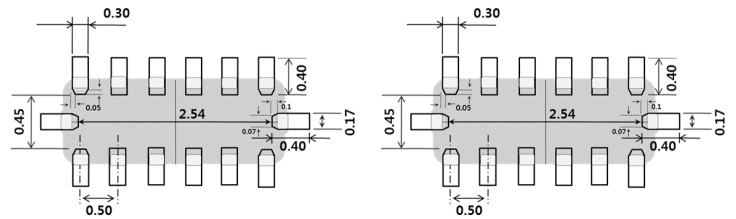
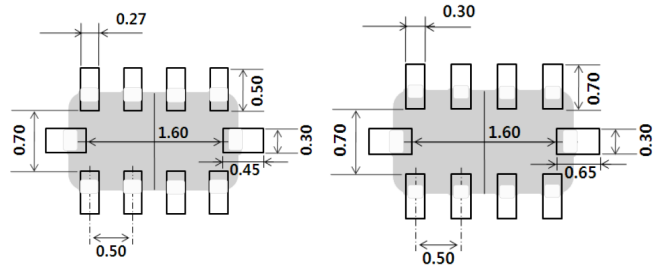
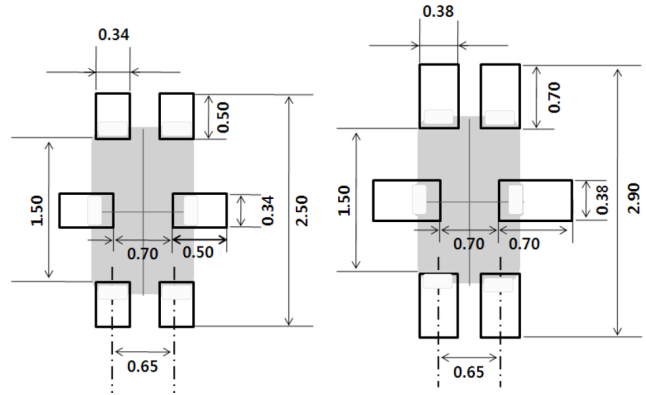

Carrie Tape Dimensions

0605mm size

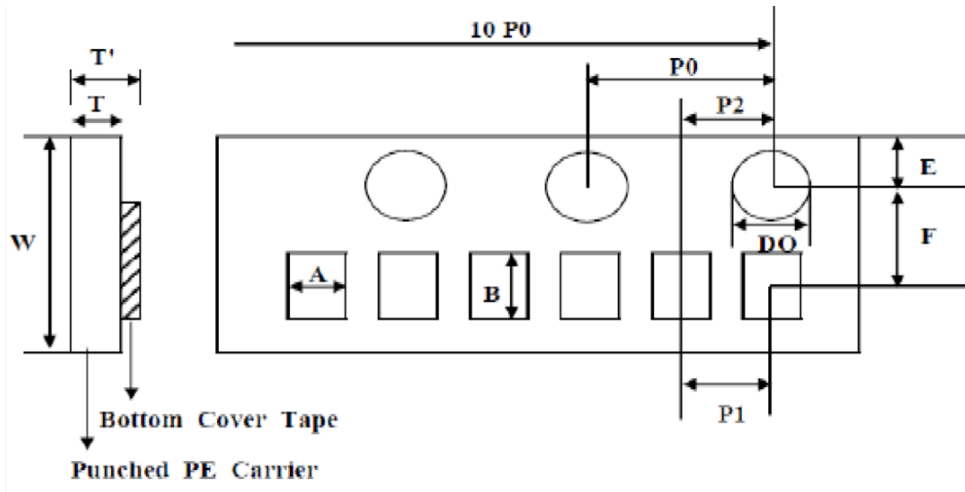

Symbol	Dimensions
	Millimeters
A	0.62±0.03
B	0.78±0.03
E	1.75±0.05
F	3.50±0.05
D0	1.55±0.03
P1	2.00±0.05
P2	2.00±0.05
P0	4.00±0.05
10P0	40.00±0.10
W	8.00±0.10
T	0.40±0.02
T'	0.43±0.05

Tape and Reel Dimension

0605mm size

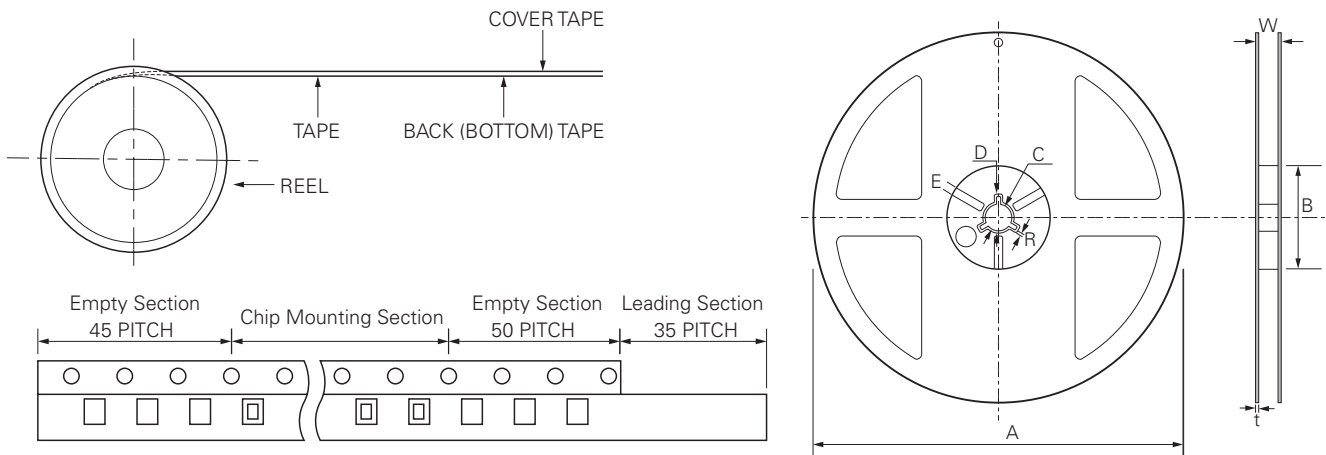

- (1) Reel Materials: Polystyrene (2) Label (3) Taping
- Standard Packing Quantity per Reel (Ø178)
- PE Tape: 10,000pcs

Code	A	B	C	D	E	W	T	R
Dimension	Ø178±2	Min. Ø50	Ø13±0.5	Ø21±0.8	2.0±0.5	10±1.5	0.8±0.2	1.0

Carrie Tape Dimensions

0806mm size

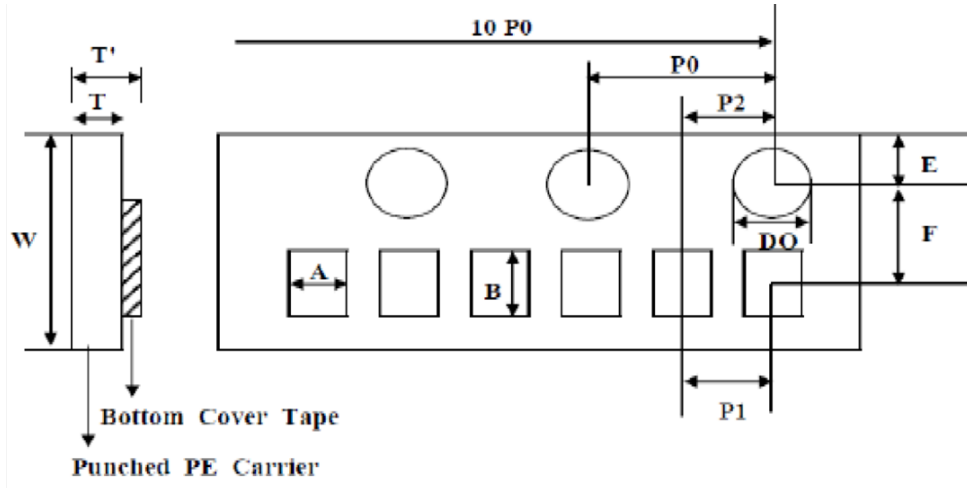

Symbol	Dimensions
	Millimeters
A	0.80±0.03
B	1.02±0.03
E	1.75±0.05
F	3.50±0.05
D0	1.55±0.03
P1	2.00±0.05
P2	2.00±0.05
P0	4.00±0.05
10P0	40.00±0.10
W	8.00±0.10
T	0.60±0.02
T'	0.63±0.05

Tape and Reel Dimension

0806mm size

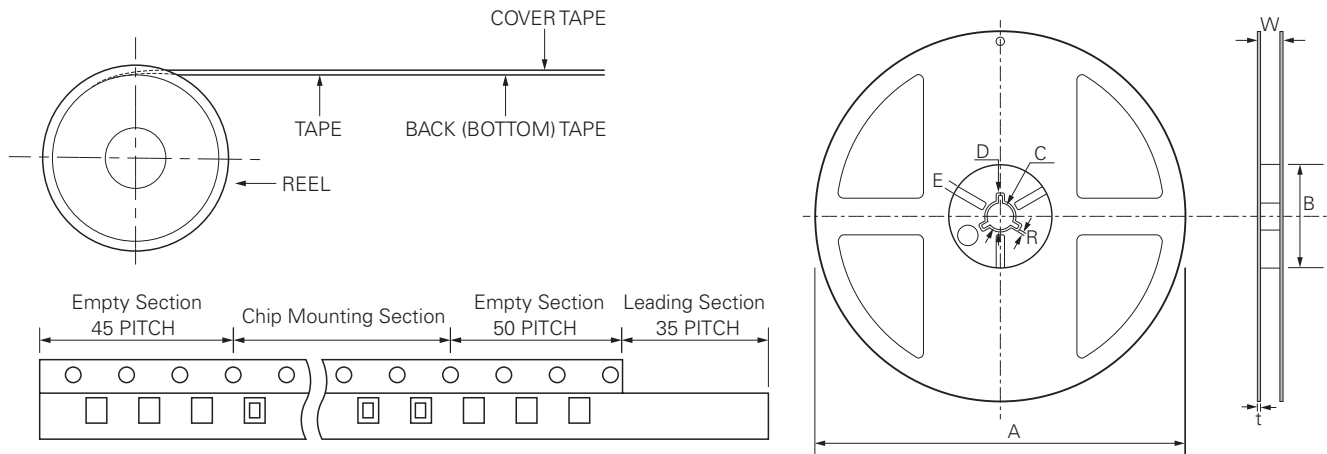

- (1) Reel Materials: Polystyrene (2) Label (3) Taping
 - Standard Packing Quantity per Reel (Ø178)
 - PE Tape: 10,000pcs

Code	A	B	C	D	E	W	T	R
Dimension	Ø178±2	Min. Ø50	Ø13±0.5	Ø21±0.8	2.0±0.5	10±1.5	0.8±0.2	1.0

Carrie Tape Dimensions

1210mm size

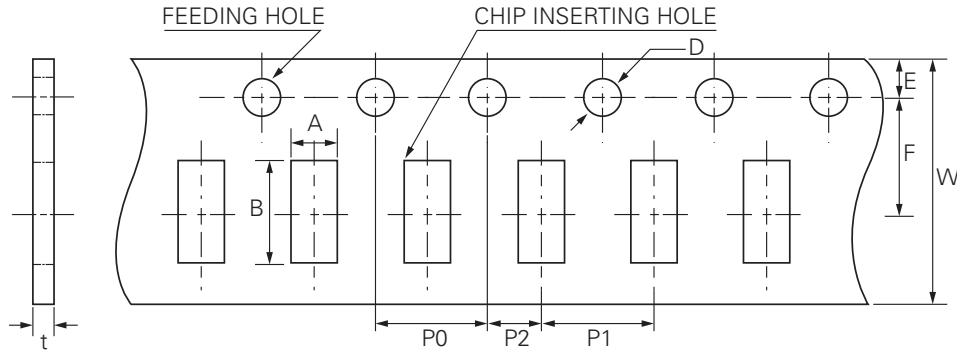

Symbol	Dimensions
	Millimeters
A	1.15±0.05
B	1.50±0.05
W	8.00+0.30-0.10
F	3.50±0.05
E	1.75±0.05
P1	4.00±0.10
P2	2.00±0.05
P0	4.00±0.05
D	1.55±0.03
T	0.75±0.05

Tape and Reel Dimension

1210mm size

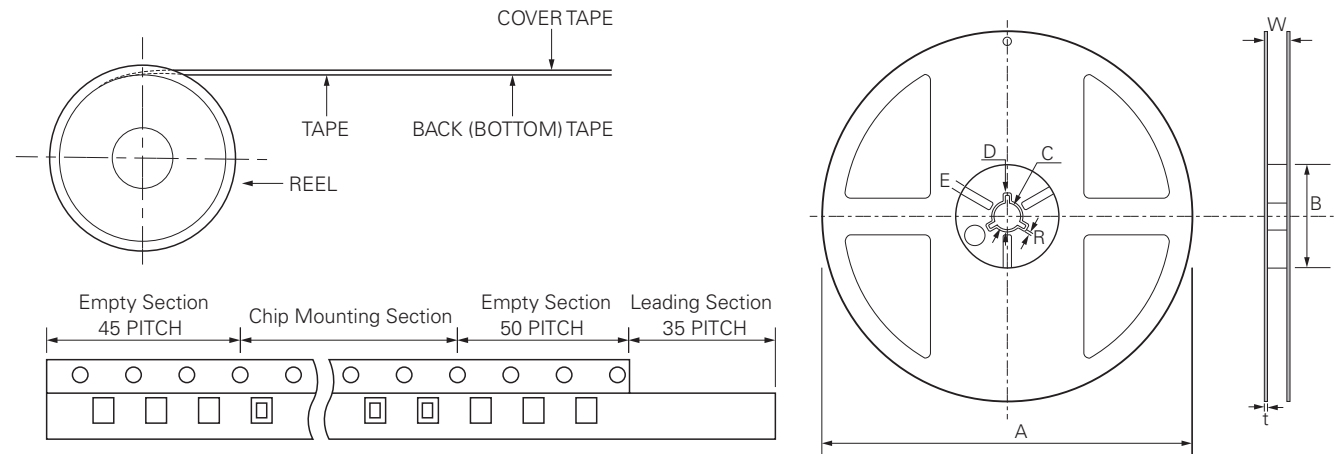

- (1) Reel Materials: Polystyrene (2) Label (3) Taping
 - Standard Packing Quantity per Reel (Ø178)
 - PE Tape: 4,000pcs

Code	A	B	C	D	E	W	T	R
Dimension	Ø178±2	Min. Ø50	Ø13±0.5	Ø21±0.8	2.0±0.5	10±1.5	0.8±0.2	1.0

Carrie Tape Dimensions

1608mm size

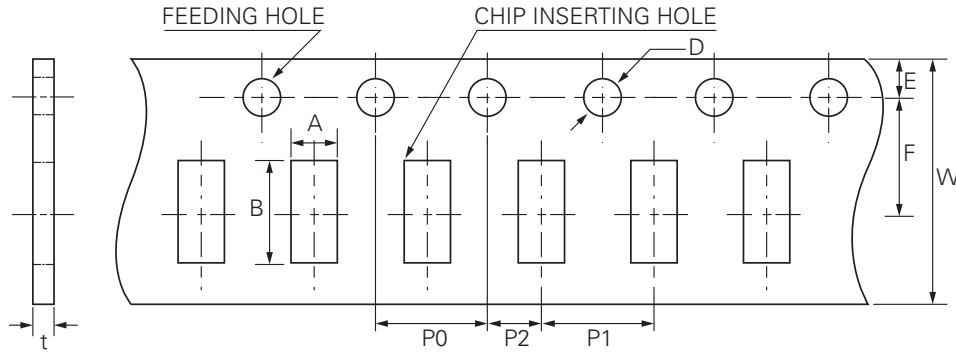

Symbol	Dimensions
	Millimeters
A	0.97±0.03
B	1.80±0.03
W	8.00±0.10
F	3.50±0.05
E	1.75±0.05
P1	4.00±0.10
P2	2.00±0.05
P0	4.00±0.05
D	1.55±0.03
T	0.58±0.03

Tape and Reel Dimension

1608mm size

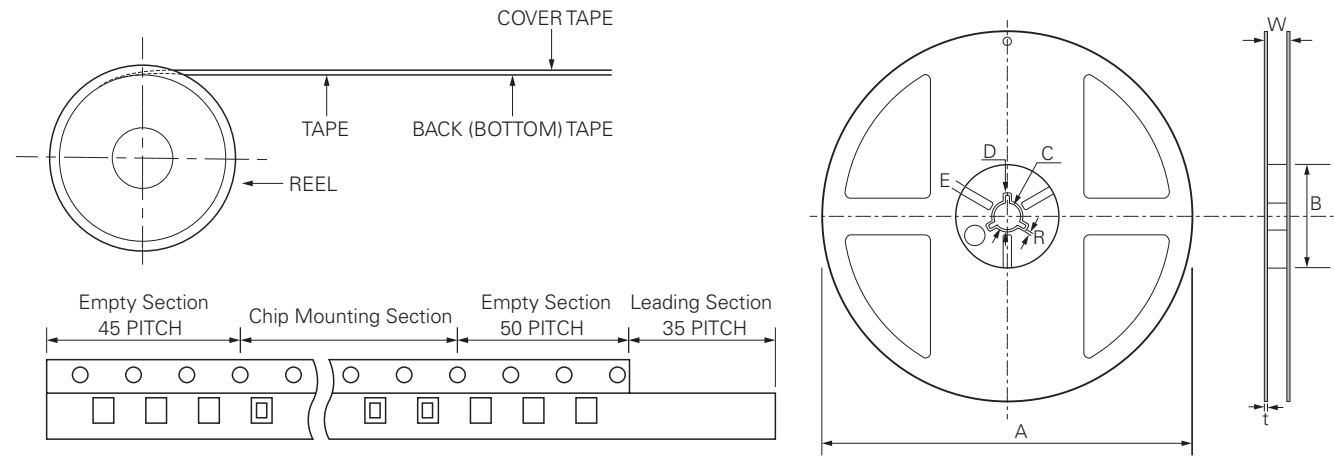

- (1) Reel Materials: Polystyrene (2) Label (3) Taping
- Standard Packing Quantity per Reel (Ø178)
- PE Tape: 4,000pcs

Code	A	B	C	D	E	W	T	R
Dimension	Ø178±2	Min. Ø50	Ø13±0.5	Ø21±0.8	2.0±0.5	10±1.5	0.8±0.2	1.0

Carrie Tape Dimensions

2012mm size

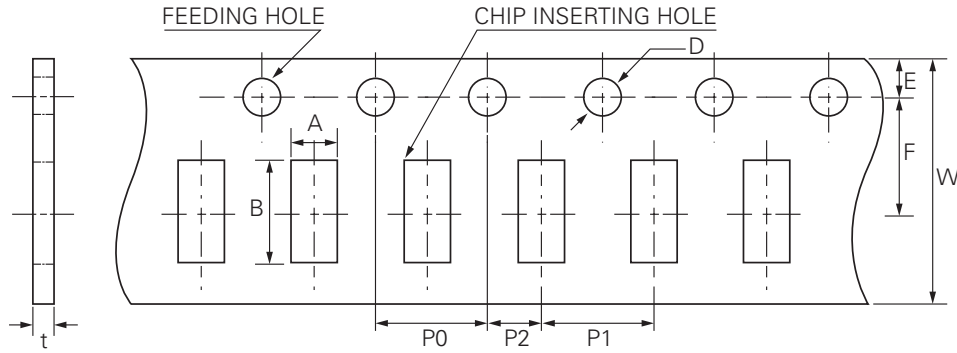

Symbol	Dimensions Millimeters
A	1.55±0.05
B	2.30±0.05
W	8.00±0.10
F	3.50±0.05
E	1.75±0.05
P1	4.00±0.10
P2	2.00±0.05
P0	4.00±0.10
D	1.55±0.03
T	0.95±0.05

Tape and Reel Dimension

2012mm size

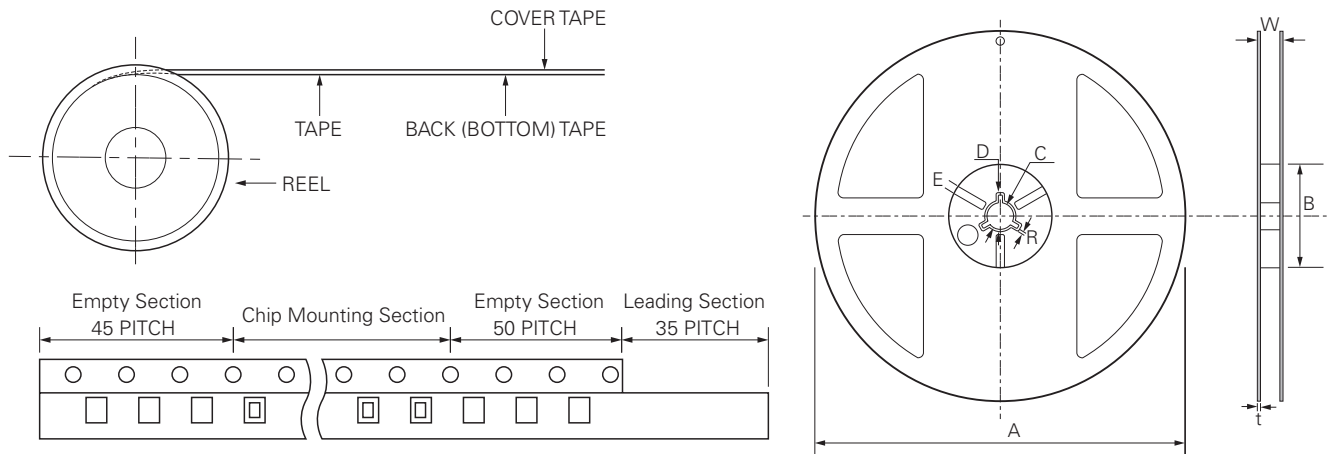

- (1) Reel Materials: Polystyrene (2) Label (3) Taping
 - Standard Packing Quantity per Reel (Ø178)
 - PE Tape: 4,000pcs

Code	A	B	C	D	E	W	T	R
Dimension	Ø178±2	Min. Ø50	Ø13±0.5	Ø21±0.8	2.0±0.5	10±1.5	0.8±0.2	1.0

Carrie Tape Dimensions

3008mm size

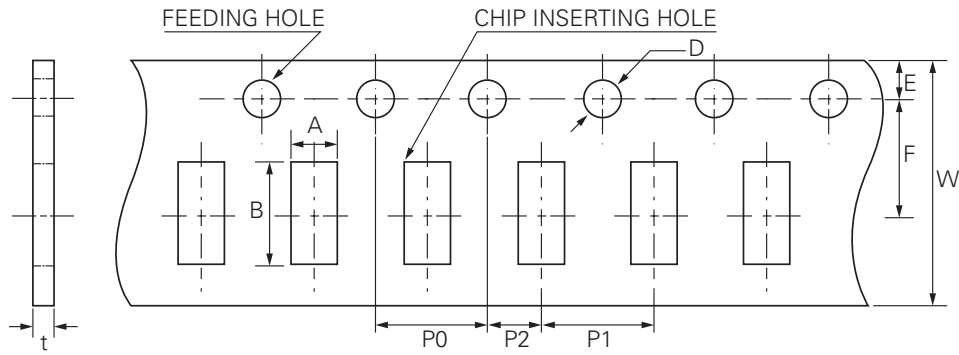

Symbol	Dimensions
	Millimeters
A	1.05±0.05
B	3.30±0.05
W	8.00±0.10
F	3.50±0.05
E	1.75±0.05
P1	4.00±0.10
P2	2.00±0.05
P0	4.00±0.10
D	1.55±0.03
T	0.60±0.05

Tape and Reel Dimension

3008mm size

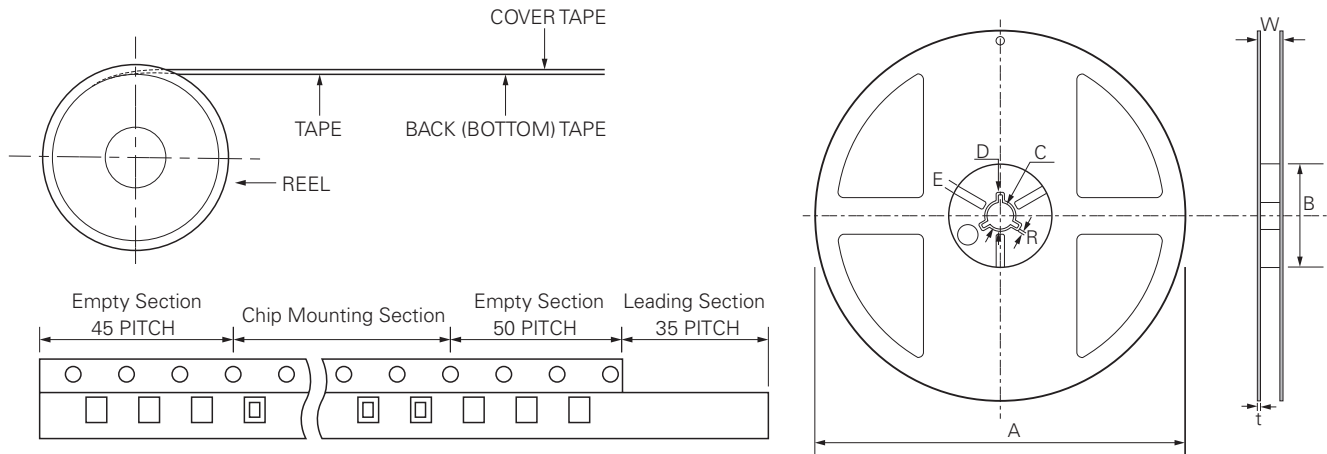

- (1) Reel Materials: Polystyrene (2) Label (3) Taping
 - Standard Packing Quantity per Reel (Ø178)
 - PE Tape: 4,000pcs

Code	A	B	C	D	E	W	T	R
Dimension	Ø178±2	Min. Ø50	Ø13±0.5	Ø21±0.8	3.0±0.5	10±1.5	1.3±0.2	1.0±0.2

Part Numbering System

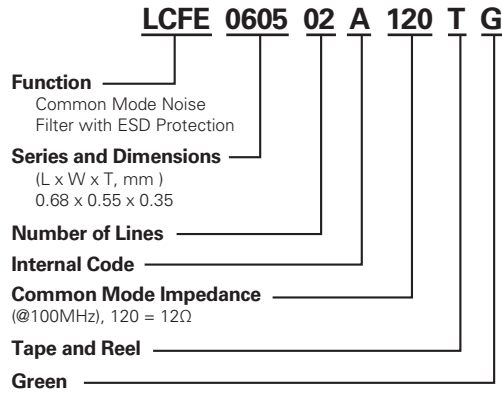

Ordering Information

Part Number	Reel Quantity
LCFE0605xxxxxxx/LCFE0806xxxxxxx	10,000
LCFE1608xxxxxxx/LCFE1210xxxxxxx	4,000
LCFE2012xxxxxxx/LCFE3008xxxxxxx	4,000

Disclaimer Notice - Information furnished is believed to be accurate and reliable. However, users should independently evaluate the suitability of and test each product selected for their own applications. Littelfuse products are not designed for, and may not be used in, all applications. Read complete Disclaimer Notice at www.littelfuse.com/disclaimer-electronics.



Компания «ЭлектроПласт» предлагает заключение долгосрочных отношений при поставках импортных электронных компонентов на взаимовыгодных условиях!

Наши преимущества:

- Оперативные поставки широкого спектра электронных компонентов отечественного и импортного производства напрямую от производителей и с крупнейших мировых складов;
- Поставка более 17-ти миллионов наименований электронных компонентов;
- Поставка сложных, дефицитных, либо снятых с производства позиций;
- Оперативные сроки поставки под заказ (от 5 рабочих дней);
- Экспресс доставка в любую точку России;
- Техническая поддержка проекта, помощь в подборе аналогов, поставка прототипов;
- Система менеджмента качества сертифицирована по Международному стандарту ISO 9001;
- Лицензия ФСБ на осуществление работ с использованием сведений, составляющих государственную тайну;
- Поставка специализированных компонентов (Xilinx, Altera, Analog Devices, Intersil, Interpoint, Microsemi, Aeroflex, Peregrine, Syfer, Eurofarad, Texas Instrument, Miteq, Cobham, E2V, MA-COM, Hittite, Mini-Circuits, General Dynamics и др.);

Помимо этого, одним из направлений компании «ЭлектроПласт» является направление «Источники питания». Мы предлагаем Вам помощь Конструкторского отдела:

- Подбор оптимального решения, техническое обоснование при выборе компонента;
- Подбор аналогов;
- Консультации по применению компонента;
- Поставка образцов и прототипов;
- Техническая поддержка проекта;
- Защита от снятия компонента с производства.



Как с нами связаться

Телефон: 8 (812) 309 58 32 (многоканальный)

Факс: 8 (812) 320-02-42

Электронная почта: org@eplast1.ru

Адрес: 198099, г. Санкт-Петербург, ул. Калинина, дом 2, корпус 4, литера А.