

MAX6029

Ultra-Low-Power Precision Series Voltage Reference

General Description

The MAX6029 micropower, low-dropout bandgap voltage reference combines ultra-low supply current and low drift in a miniature 5-pin SOT23 surface-mount package that uses 70% less board space than comparable devices in an SO package. An initial accuracy of 0.15% and a 30ppm/°C (max) temperature coefficient make the MAX6029 suitable for precision applications. This series-mode voltage reference sources up to 4mA and sinks up to 1mA of load current. A wide 2.5V to 12.6V supply range, ultra-low 5.25µA (max) supply current, and a low 200mV dropout voltage make these devices ideal for battery-operated systems. Additionally, an internal compensation capacitor eliminates the need for an external compensation capacitor and ensures stability with load capacitances up to 10µF.

The MAX6029 provides six output voltages of 2.048V, 2.5V, 3V, 3.3V, 4.096V, and 5V. The MAX6029 is available in a 5-pin SOT23 or an 8-pin SO package and is specified over the extended temperature range (-40°C to +85°C).

Applications

- Battery-Powered Systems
- Hand-Held Instruments
- Precision Power Supplies
- A/D and D/A Converters

Features

- Ultra-Low 5.25µA (max) Supply Current
- ±0.15% (max) Initial Accuracy
- 30ppm/°C (max) Temperature Coefficient
- 4mA Output Source Current
- 1mA Output Sink Current
- 2.5V to 12.6V Supply Range
- Low 200mV Dropout
- Stable with Capacitive Loads Up to 10µF
- No External Capacitors Required
- Miniature 5-Pin SOT23 Package, 8-Pin SO Package

Ordering Information

PART	PIN-PACKAGE	TOP MARK
MAX6029EUK21+T	5 SOT23	AEHD
MAX6029EUK25+T	5 SOT23	AEHF
MAX6029ESA25+	8 SO	—
MAX6029EUK30+T	5 SOT23	AEHH
MAX6029EUK33+T	5 SOT23	AEHN
MAX6029EUK41+T	5 SOT23	AEHJ
MAX6029ESA41+	8 SO	—
MAX6029EUK50+T	5 SOT23	AEHL

Note: All devices are specified over the -40°C to +85°C operating temperature range.

+Denotes a lead(Pb)-free/RoHS-compliant package.

Pin Configuration

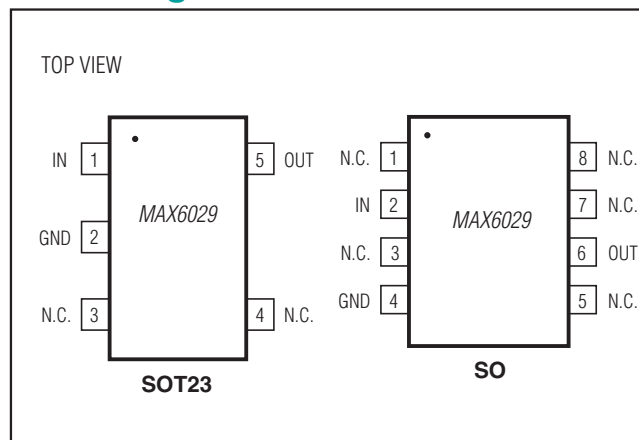

Selector Guide

PART	PIN-PACKAGE	OUTPUT VOLTAGE (V)
MAX6029EUK21	5 SOT23	2.048
MAX6029EUK25	5 SOT23	2.500
MAX6029ESA25	8 SO	2.500
MAX6029EUK30	5 SOT23	3.000
MAX6029EUK33	5 SOT23	3.300
MAX6029EUK41	5 SOT23	4.096
MAX6029ESA41	8 SO	4.096
MAX6029EUK50	5 SOT23	5.000

Absolute Maximum Ratings

IN to GND-0.3V to +13V
 OUT to GND-0.3V to the lower of +6V and (V_{IN} + 0.3V)
 Output to GND Short-Circuit Duration.....Continuous
 Continuous Power Dissipation (T_A = +70°C)
 5-Pin SOT23 (derate 7.1mW/°C above +70°C).....571mW
 8-Pin SO (derate 5.9mW/°C above +70°C).....470.6mW

Operating Temperature Range-40°C to +85°C
 Storage Temperature Range-65°C to +150°C
 Lead Temperature (soldering, 10s)+300°C

Stresses beyond those listed under "Absolute Maximum Ratings" may cause permanent damage to the device. These are stress ratings only, and functional operation of the device at these or any other conditions beyond those indicated in the operational sections of the specifications is not implied. Exposure to absolute maximum rating conditions for extended periods may affect device reliability.

Electrical Characteristics—MAX6029_21 (V_{OUT} = 2.048V)

(V_{IN} = 2.5V, I_{OUT} = 0, T_A = T_{MIN} to T_{MAX}, unless otherwise noted. Typical values are at T_A = +25°C.) (Note 1)

PARAMETER	SYMBOL	CONDITIONS	MIN	TYP	MAX	UNITS
OUTPUT						
Output Voltage	V _{OUT}	T _A = +25°C	2.0449	2.0480	2.0511	V
Output Voltage Temperature Coefficient	TCV _{OUT}	(Notes 2, 3)			30	ppm/°C
Line Regulation	ΔV _{OUT} /ΔV _{IN}	V _{IN} = 2.5V to 12.6V		27	200	μV/V
Load Regulation	ΔV _{OUT} /ΔI _{OUT}	I _{OUT} = 0 to 4mA		0.22	0.7	μV/μA
		I _{OUT} = 0 to -1mA		2.4	5.5	
Output Short-Circuit Current	I _{SC}			60		mA
Long-Term Stability	ΔV _{OUT} /time	1000 hours at +25°C		150		ppm
Thermal Hysteresis		(Note 4)		140		ppm
DYNAMIC CHARACTERISTICS						
Noise Voltage	e _{OUT}	f = 0.1Hz to 10Hz		30		μV _{P-P}
		f = 10Hz to 1kHz		115		μV _{RMS}
Ripple Rejection	ΔV _{OUT} /ΔV _{IN}	V _{IN} = 2.5V ±200mV, f = 120Hz		43		dB
Turn-On Settling Time	t _R	To V _{OUT} = 0.1% of final value		450		μs
INPUT						
Supply Voltage Range	V _{IN}		2.5		12.6	V
Supply Current	I _{IN}				5.25	μA
Change in Supply Current	I _{IN} /V _{IN}	V _{IN} = 2.5V to 12.6V			1.5	μA/V

Electrical Characteristics—MAX6029_25 (V_{OUT} = 2.500V)(V_{IN} = 2.7V, I_{OUT} = 0, T_A = T_{MIN} to T_{MAX}, unless otherwise noted. Typical values are at T_A = +25°C.) (Note 1)

PARAMETER	SYMBOL	CONDITIONS	MIN	TYP	MAX	UNITS	
OUTPUT							
Output Voltage	V _{OUT}	T _A = +25°C	MAX6029EUK	2.4963	2.5000	2.5038	V
			MAX6029ESA	2.495	2.500	2.505	
Output Voltage Temperature Coefficient	TCV _{OUT}	(Notes 2, 3)			30	ppm/°C	
Line Regulation	ΔV _{OUT} /ΔV _{IN}	V _{IN} = 2.7V to 12.6V		30	230	μV/V	
Load Regulation	ΔV _{OUT} /ΔI _{OUT}	I _{OUT} = 0 to 4mA		0.1	0.6	μV/μA	
		I _{OUT} = 0 to -1mA		2.5	6.2		
Dropout Voltage (Note 5)	V _{IN} - V _{OUT}	I _{OUT} = 0			100	mV	
		I _{OUT} = 4mA			200		
Output Short-Circuit Current	I _{SC}			60		mA	
Long-Term Stability	ΔV _{OUT} /time	1000 hours at +25°C		150		ppm	
Thermal Hysteresis		(Note 4)		140		ppm	
DYNAMIC CHARACTERISTICS							
Noise Voltage	e _{OUT}	f = 0.1Hz to 10Hz		39		μV _{P-P}	
		f = 10Hz to 1kHz		137		μV _{RMS}	
Ripple Rejection	ΔV _{OUT} /ΔV _{IN}	V _{IN} = 2.7V ±200mV, f = 120Hz		34		dB	
Turn-On Settling Time	t _R	To V _{OUT} = 0.1% of final value		700		ms	
INPUT							
Supply Voltage Range	V _{IN}		2.7		12.6	V	
Supply Current	I _{IN}				5.75	μA	
Change in Supply Current	I _{IN} /V _{IN}	V _{IN} = 2.7V to 12.6V			1.5	μA/V	

Electrical Characteristics—MAX6029_30 (V_{OUT} = 3.000V)(V_{IN} = 3.2V, I_{OUT} = 0, T_A = T_{MIN} to T_{MAX}, unless otherwise noted. Typical values are at T_A = +25°C.) (Note 1)

PARAMETER	SYMBOL	CONDITIONS	MIN	TYP	MAX	UNITS
OUTPUT						
Output Voltage	V _{OUT}	T _A = +25°C	2.9955	3.0000	3.0045	V
Output Voltage Temperature Coefficient	TCV _{OUT}	(Notes 2, 3)			30	ppm/°C
Line Regulation	ΔV _{OUT} /ΔV _{IN}	V _{IN} = 3.2V to 12.6V		15	250	μV/V
Load Regulation	ΔV _{OUT} /ΔI _{OUT}	I _{OUT} = 0 to 4mA		0.1	0.6	μV/μA
		I _{OUT} = 0 to -1mA		2.4	6.5	
Dropout Voltage (Note 5)	V _{IN} - V _{OUT}	I _{OUT} = 0			100	mV
		I _{OUT} = 4mA			200	
Output Short-Circuit Current	I _{SC}			60		mA
Long-Term Stability	ΔV _{OUT} /time	1000 hours at +25°C		150		ppm
Thermal Hysteresis		(Note 4)		140		ppm
DYNAMIC CHARACTERISTICS						
Noise Voltage	e _{OUT}	f = 0.1Hz to 10Hz		39		μV _{P-P}
		f = 10Hz to 1kHz		161		μV _{RMS}
Ripple Rejection	ΔV _{OUT} /ΔV _{IN}	V _{IN} = 3.2V ±200mV, f = 120Hz		37		dB
Turn-On Settling Time	t _R	To V _{OUT} = 0.1% of final value		775		μs
INPUT						
Supply Voltage Range	V _{IN}		3.2		12.6	V
Supply Current	I _{IN}				6.75	μA
Change in Supply Current	I _{IN} /V _{IN}	V _{IN} = 3.2V to 12.6V			1.5	μA/V

Electrical Characteristics—MAX6029_33 (V_{OUT} = 3.000V)(V_{IN} = 3.5V, I_{OUT} = 0, T_A = T_{MIN} to T_{MAX}, unless otherwise noted. Typical values are at T_A = +25°C.) (Note 1)

PARAMETER	SYMBOL	CONDITIONS	MIN	TYP	MAX	UNITS
OUTPUT						
Output Voltage	V _{OUT}	T _A = +25°C	3.2951	3.3000	3.3050	V
Output Voltage Temperature Coefficient	TCV _{OUT}	(Notes 2, 3)			30	ppm/°C
Line Regulation	ΔV _{OUT} /ΔV _{IN}	V _{IN} = 3.5V to 12.6V		30	270	μV/V
Load Regulation	ΔV _{OUT} /ΔI _{OUT}	I _{OUT} = 0 to 4mA		0.1	0.6	μV/μA
		I _{OUT} = 0 to -1mA		2.4	7	
Dropout Voltage (Note 5)	V _{IN} - V _{OUT}	I _{OUT} = 0			100	mV
		I _{OUT} = 4mA			200	
Output Short-Circuit Current	I _{SC}			60		mA
Long-Term Stability	ΔV _{OUT} /time	1000 hours at +25°C		150		ppm
Thermal Hysteresis		(Note 4)		140		ppm
DYNAMIC CHARACTERISTICS						
Noise Voltage	e _{OUT}	f = 0.1Hz to 10Hz		56		μV _{P-P}
		f = 10Hz to 1kHz		174		μV _{RMS}
Ripple Rejection	ΔV _{OUT} /ΔV _{IN}	V _{IN} = 3.5V ±200mV, f = 120Hz		38		dB
Turn-On Settling Time	t _R	To V _{OUT} = 0.1% of final value		1		ms
INPUT						
Supply Voltage Range	V _{IN}		3.5		12.6	V
Supply Current	I _{IN}				7.25	μA
Change in Supply Current	I _{IN} /V _{IN}	V _{IN} = 3.5V to 12.6V			1.5	μA/V

Electrical Characteristics—MAX6029_41 (V_{OUT} = 4.096V)(V_{IN} = 4.3V, I_{OUT} = 0, T_A = T_{MIN} to T_{MAX}, unless otherwise noted. Typical values are at T_A = +25°C.) (Note 1)

PARAMETER	SYMBOL	CONDITIONS	MIN	TYP	MAX	UNITS	
OUTPUT							
Output Voltage	V _{OUT}	T _A = +25°C	MAX6029EUK	4.0899	4.0960	4.1021	V
			MAX6029ESA	4.088	4.096	4.104	
Output Voltage Temperature Coefficient	TCV _{OUT}	(Notes 2, 3)			30	ppm/°C	
Line Regulation	ΔV _{OUT} /ΔV _{IN}	V _{IN} = 4.3V to 12.6V		30	310	μV/V	
Load Regulation	ΔV _{OUT} /ΔI _{OUT}	I _{OUT} = 0 to 4mA		0.1	0.6	μV/μA	
		I _{OUT} = 0 to -1mA		2.5	8.5		
Dropout Voltage (Note 5)	V _{IN} - V _{OUT}	I _{OUT} = 0			100	mV	
		I _{OUT} = 4mA			200		
Output Short-Circuit Current	I _{SC}			60		mA	
Long-Term Stability	ΔV _{OUT} /time	1000 hours at +25°C		150		ppm	
Thermal Hysteresis		(Note 4)		140		ppm	
DYNAMIC CHARACTERISTICS							
Noise Voltage	e _{OUT}	f = 0.1Hz to 10Hz		72		μV _{P-P}	
		f = 10Hz to 1kHz		210		μV _{RMS}	
Ripple Rejection	ΔV _{OUT} /ΔV _{IN}	V _{IN} = 4.3V ±200mV, f = 120Hz		36		dB	
Turn-On Settling Time	t _R	To V _{OUT} = 0.1% of final value		1.2		ms	
INPUT							
Supply Voltage Range	V _{IN}		4.3		12.6	V	
Supply Current	I _{IN}				8.75	μA	
Change in Supply Current	I _{IN} /V _{IN}	V _{IN} = 4.3V to 12.6V			1.5	μA/V	

Electrical Characteristics—MAX6029_50 (V_{OUT} = 5.000V)(V_{IN} = 5.2V, I_{OUT} = 0, T_A = T_{MIN} to T_{MAX}, unless otherwise noted. Typical values are at T_A = +25°C.) (Note 1)

PARAMETER	SYMBOL	CONDITIONS	MIN	TYP	MAX	UNITS
OUTPUT						
Output Voltage	V _{OUT}	T _A = +25°C	4.9925	5.0000	5.0075	V
Output Voltage Temperature Coefficient	TCV _{OUT}	(Notes 2, 3)			30	ppm/°C
Line Regulation	ΔV _{OUT} /ΔV _{IN}	V _{IN} = 5.2V to 12.6V		34	375	μV/V
Load Regulation	ΔV _{OUT} /ΔI _{OUT}	I _{OUT} = 0 to 4mA		0.3	0.8	μV/μA
		I _{OUT} = 0 to -1mA		3.3	9	
Dropout Voltage (Note 5)	V _{IN} - V _{OUT}	I _{OUT} = 0			100	mV
		I _{OUT} = 4mA			200	
Output Short-Circuit Current	I _{SC}			60		mA
Long-Term Stability	ΔV _{OUT} /time	1000 hours at +25°C		150		ppm
Thermal Hysteresis		(Note 4)		140		ppm
DYNAMIC CHARACTERISTICS						
Noise Voltage	e _{OUT}	f = 0.1Hz to 10Hz		90		μV _{P-P}
		f = 10Hz to 1kHz		245		μV _{RMS}
Ripple Rejection	ΔV _{OUT} /ΔV _{IN}	V _{IN} = 5.2V ±200mV, f = 120Hz		38		dB
Turn-On Settling Time	t _R	To V _{OUT} = 0.1% of final value		1.4		ms
INPUT						
Supply Voltage Range	V _{IN}		5.2		12.6	V
Supply Current	I _{IN}				10.5	μA
Change in Supply Current	I _{IN} /V _{IN}	V _{IN} = 5.2V to 12.6V			1.5	μA/V

Note 1: MAX6029 is 100% production tested at T_A = +25°C and is guaranteed by design for T_A = T_{MIN} to T_{MAX} as specified.**Note 2:** Temperature coefficient is defined by box method: (V_{MAX} - V_{MIN})/(ΔT × V_{+25°C}).**Note 3:** Not production tested. Guaranteed by design.**Note 4:** Thermal hysteresis is defined as the change in T_A = +25°C output voltage before and after temperature cycling of the device (from T_A = T_{MIN} to T_{MAX}). Initial measurement at T_A = +25°C is followed by temperature cycling the device to T_A = +85°C then to T_A = -40°C and another measurement at T_A = +25°C is compared to the original measurement at T_A = +25°C.**Note 5:** Dropout voltage is the minimum input voltage at which V_{OUT} changes by 0.1% from V_{OUT} at rated V_{IN} and is guaranteed by Load Regulation Test.

Typical Operating Characteristics

($V_{IN} = 2.5V$ for MAX6029EUK21, $V_{IN} = 3.2V$ for MAX6029EUK30, and $V_{IN} = 5.2V$ for MAX6029EUK50, $I_{OUT} = 0$, $T_A = +25^\circ C$, unless otherwise noted.)

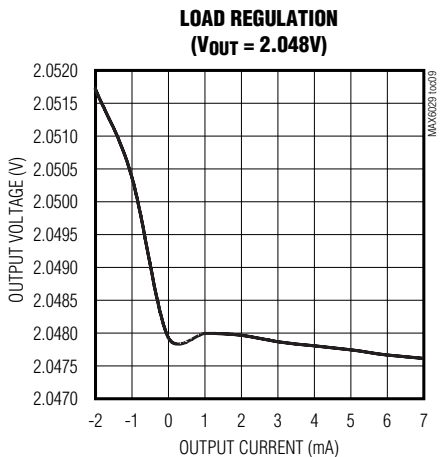
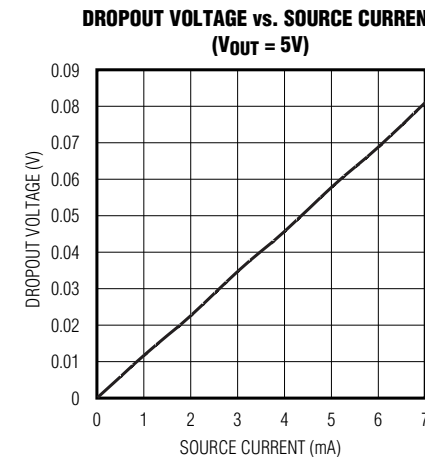
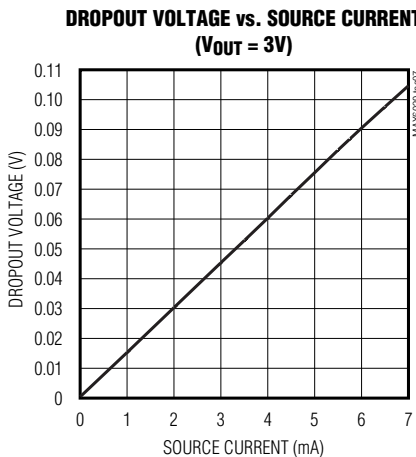
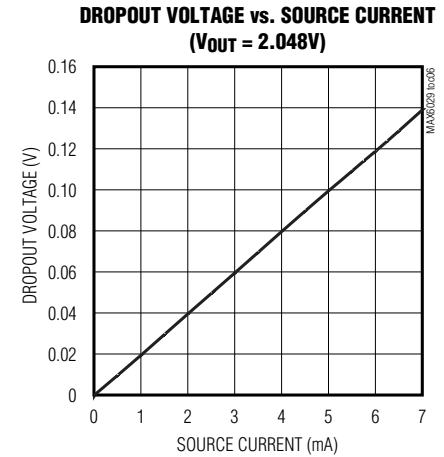
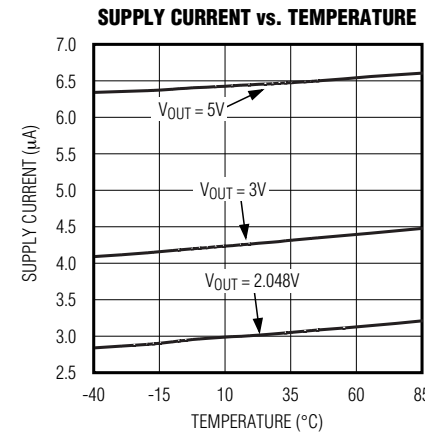
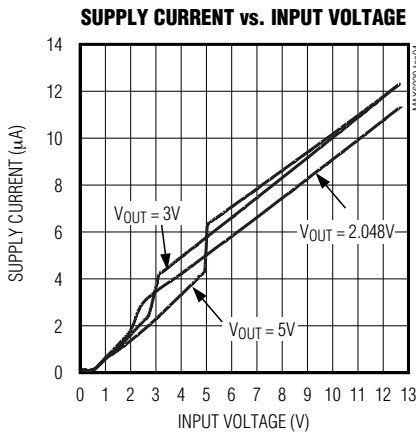
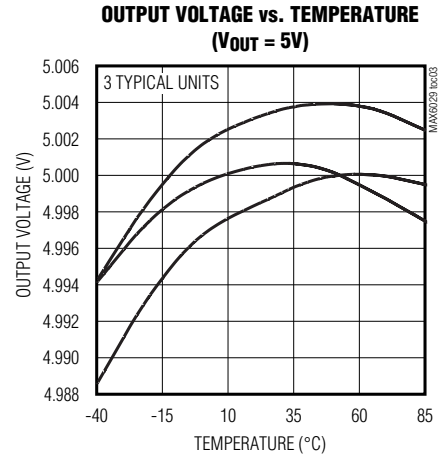
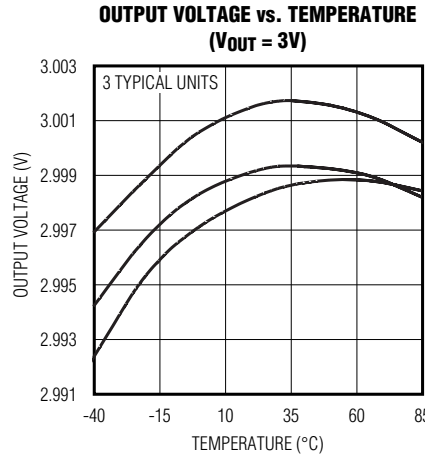
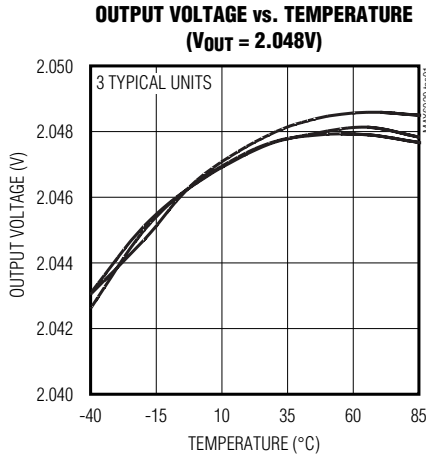

Typical Operating Characteristics (continued)

($V_{IN} = 2.5V$ for MAX6029EUK21, $V_{IN} = 3.2V$ for MAX6029EUK30, and $V_{IN} = 5.2V$ for MAX6029EUK50, $I_{OUT} = 0$, $T_A = +25^\circ C$, unless otherwise noted.)

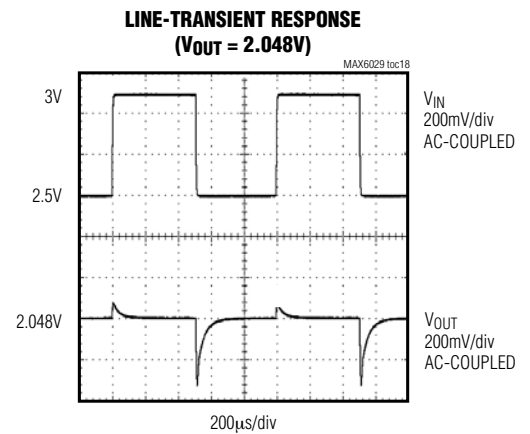
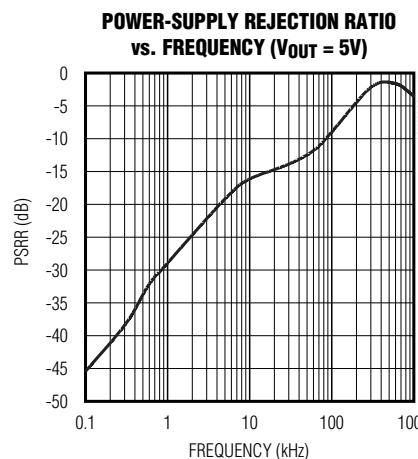
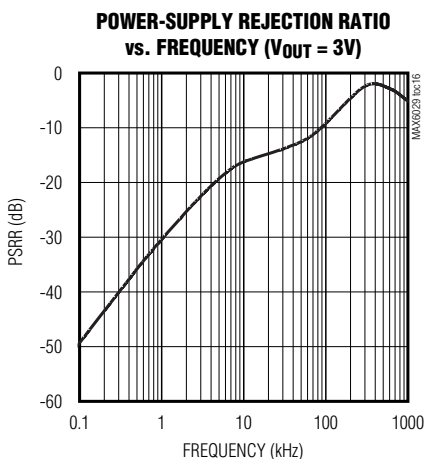
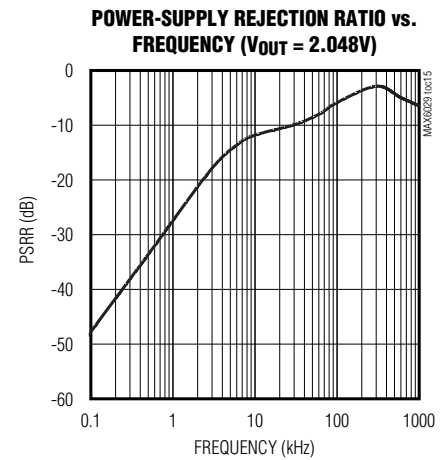
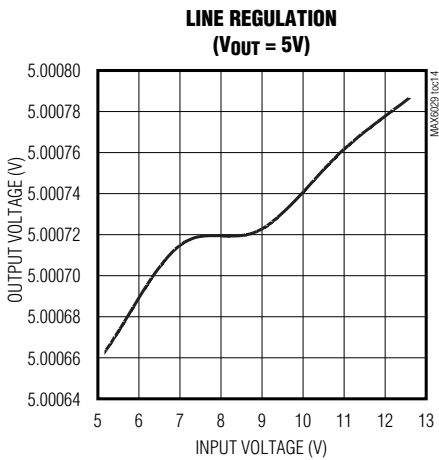
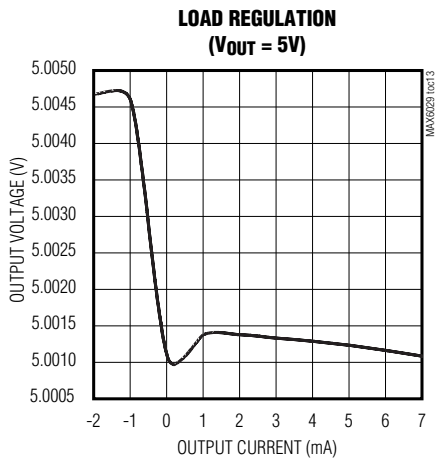
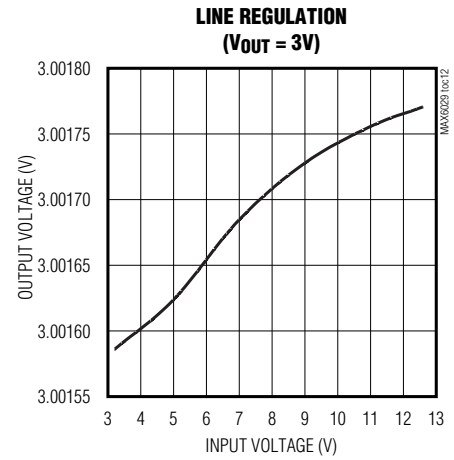
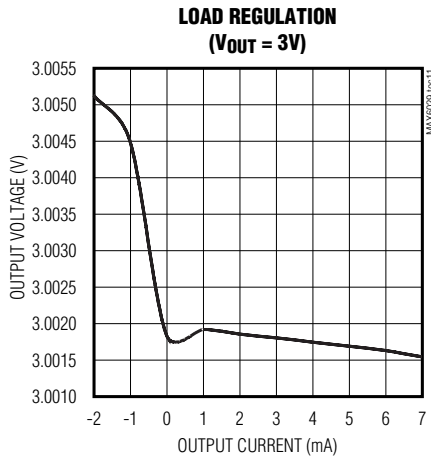
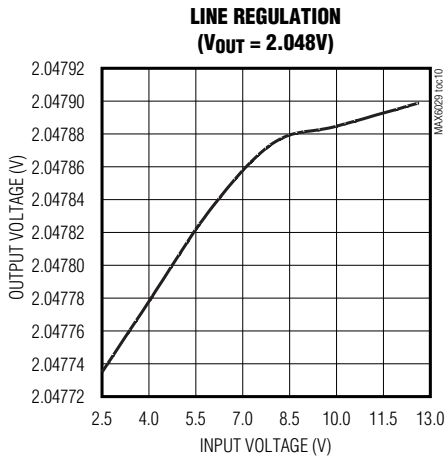

Typical Operating Characteristics (continued)

($V_{IN} = 2.5V$ for MAX6029EUK21, $V_{IN} = 3.2V$ for MAX6029EUK30, and $V_{IN} = 5.2V$ for MAX6029EUK50, $I_{OUT} = 0$, $T_A = +25^\circ C$, unless otherwise noted.)

LINE-TRANSIENT RESPONSE
($V_{OUT} = 3V$)

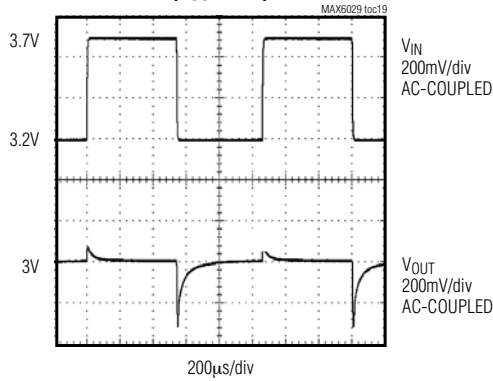

LINE-TRANSIENT RESPONSE
($V_{OUT} = 5V$)

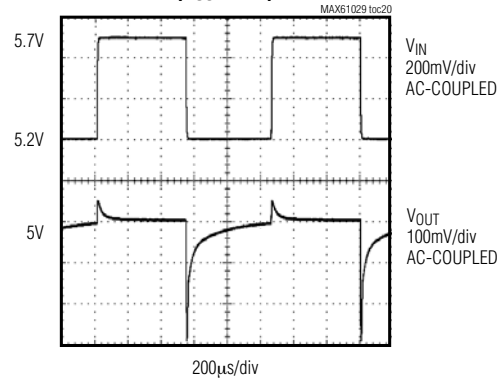

LOAD-TRANSIENT RESPONSE
(SOURCING, $V_{OUT} = 2.048V$)

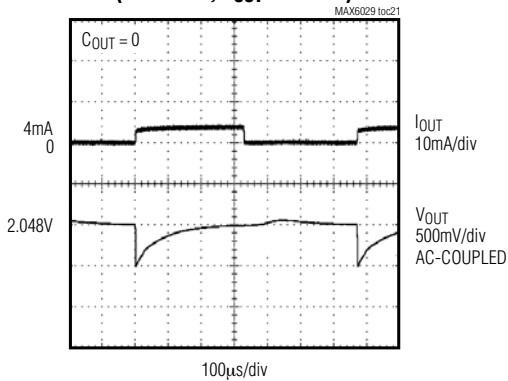

LOAD-TRANSIENT RESPONSE
(SINKING, $V_{OUT} = 2.048V$)

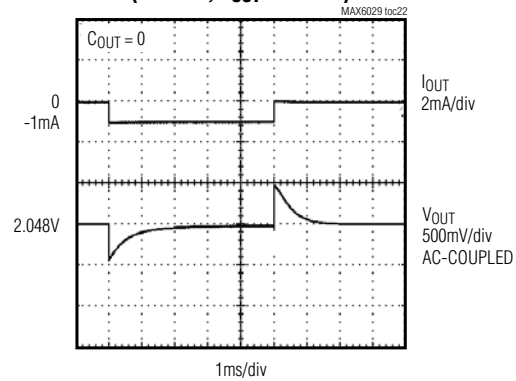

LOAD-TRANSIENT RESPONSE
(SOURCING, $V_{OUT} = 2.048V$)

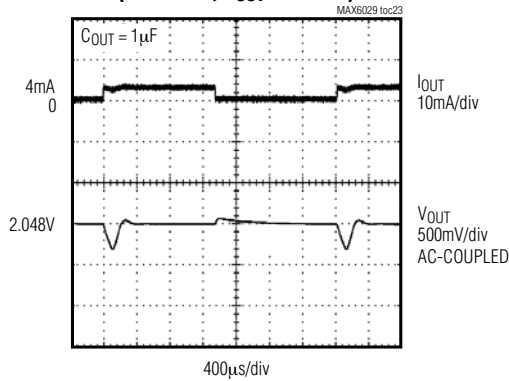

LOAD-TRANSIENT RESPONSE
(SINKING, $V_{OUT} = 2.048V$)

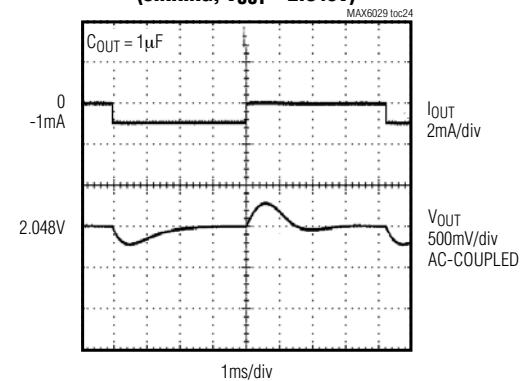

Typical Operating Characteristics (continued)

($V_{IN} = 2.5V$ for MAX6029EUK21, $V_{IN} = 3.2V$ for MAX6029EUK30, and $V_{IN} = 5.2V$ for MAX6029EUK50, $I_{OUT} = 0$, $T_A = +25^{\circ}C$, unless otherwise noted.)

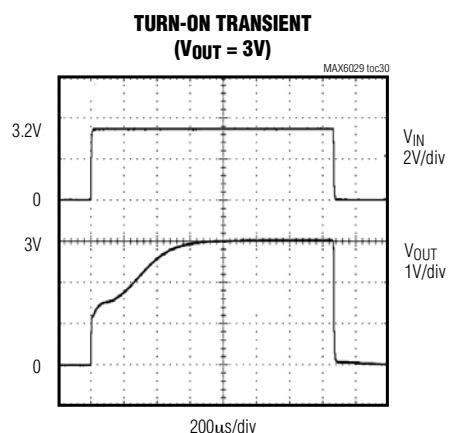
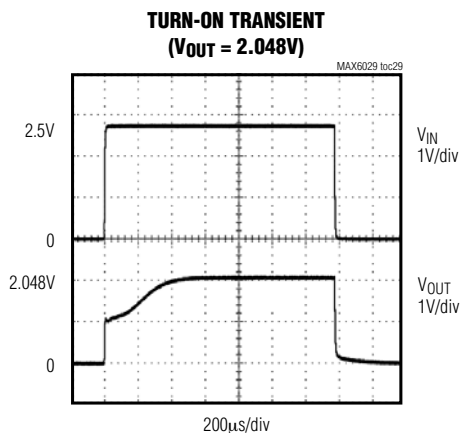
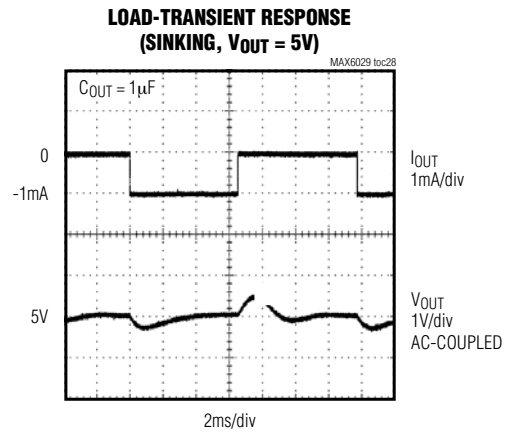
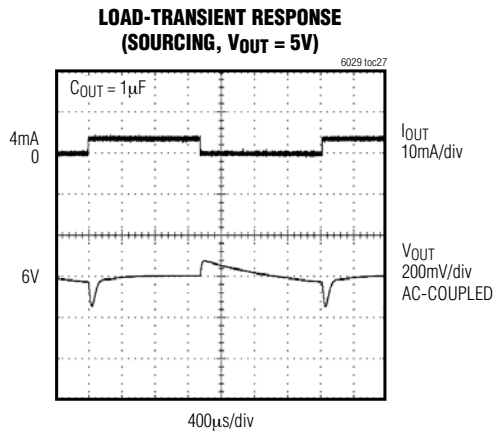
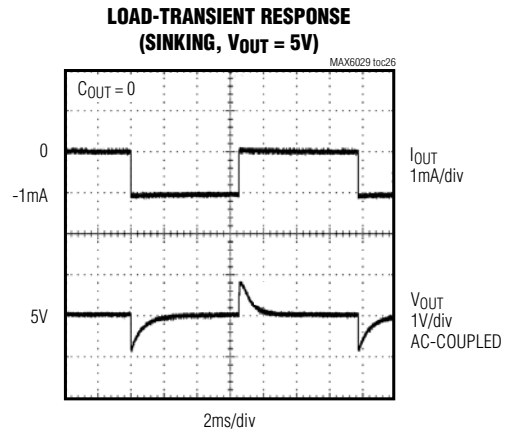
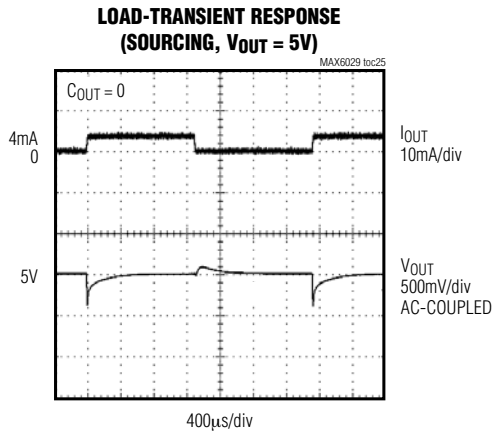

Typical Operating Characteristics (continued)

($V_{IN} = 2.5V$ for MAX6029EUK21, $V_{IN} = 3.2V$ for MAX6029EUK30, and $V_{IN} = 5.2V$ for MAX6029EUK50, $I_{OUT} = 0$, $T_A = +25^\circ C$, unless otherwise noted.)

TURN-ON TRANSIENT
($V_{OUT} = 5V$)

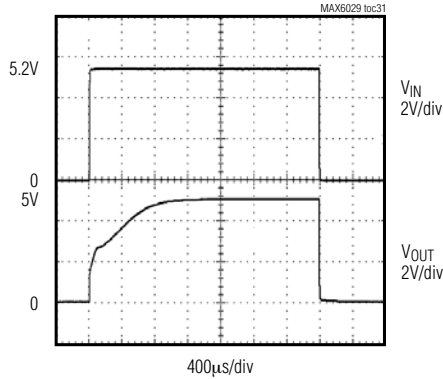

0.1Hz TO 10Hz OUTPUT NOISE
($V_{OUT} = 2.048V$)

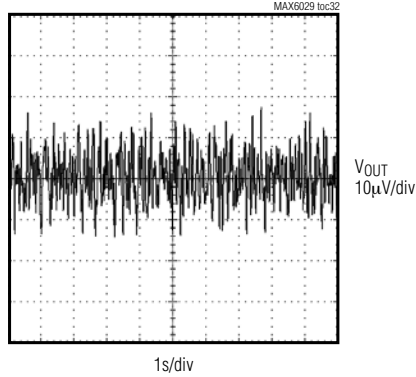

0.1Hz TO 10Hz OUTPUT NOISE
($V_{OUT} = 3V$)

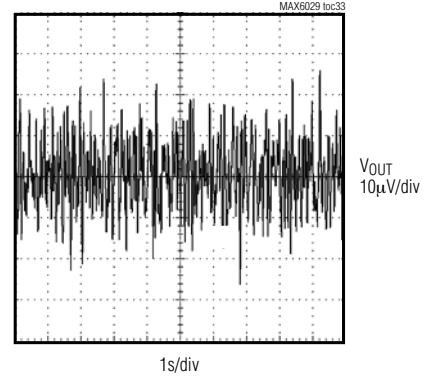

0.1Hz TO 10Hz OUTPUT NOISE
($V_{OUT} = 5V$)

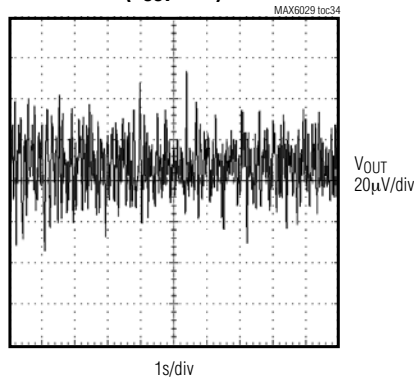

NOISE vs. FREQUENCY
($V_{OUT} = 2.048V$)

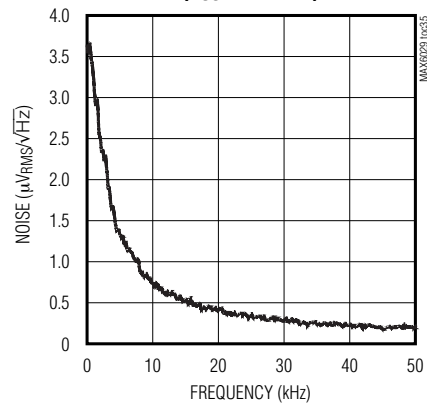

NOISE vs. FREQUENCY
($V_{OUT} = 3V$)

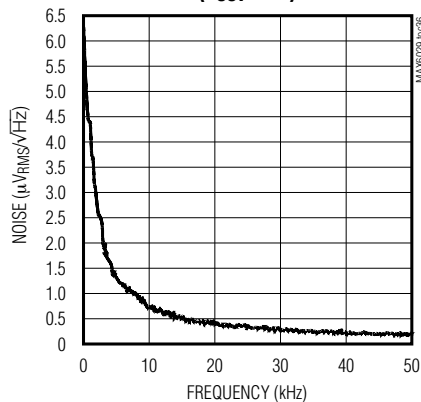

NOISE vs. FREQUENCY
($V_{OUT} = 5V$)

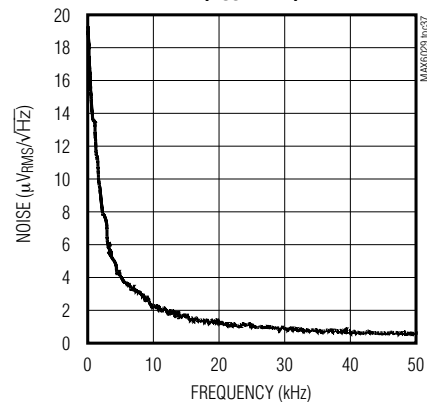

Pin Description

PIN		NAME	FUNCTION
SOT23	SO		
1	2	IN	Positive Voltage Supply
2	4	GND	Ground
3, 4	1, 3, 5, 7, 8	N.C.	No Connection. Leave unconnected or connect to ground.
5	6	OUT	Reference Output

Applications Information

Input Bypassing

The MAX6029 does not require an input bypass capacitor. For improved transient performance, bypass the input to ground with a 0.1µF ceramic capacitor. Place the capacitor as close to IN as possible.

Load Capacitance

The MAX6029 does not require an output capacitor for stability. The MAX6029 is stable driving capacitive loads from 0 to 100pF and 0.1µF to 10µF when sourcing current and from 0 to 0.4µF when sinking current. In applications where the load or the supply can experience step changes, an output capacitor reduces the amount of overshoot (undershoot) and improves the circuit's transient response. Many applications do not require an external capacitor, and the MAX6029 offers a significant advantage in applications where board space is critical.

Supply Current

The quiescent supply current of the series-mode MAX6029 is very small, 5.25µA (max), and is very stable against changes in the supply voltage with only 1.5µA/V (max) variation with supply voltage. The

MAX6029 family draws load current from the input voltage source only when required, so supply current is not wasted and efficiency is maximized at all input voltages. This improved efficiency reduces power dissipation and extends battery life.

Output Thermal Hysteresis

Output thermal hysteresis is the change of the output voltage at $T_A = +25^\circ\text{C}$ before and after the device is cycled over its entire operating temperature range. Hysteresis is caused by differential package stress appearing across the device.

Temperature Coefficient vs. Operating Temperature Range for a 1LSB Maximum Error

In a data converter application, the reference voltage of the converter must stay within a certain limit to keep the error in the data converter smaller than the resolution limit through the operating temperature range. Figure 1 shows the maximum allowable reference voltage temperature coefficient to keep the conversion error to less than 1 LSB, as a function of the operating temperature range ($T_{MAX} - T_{MIN}$) with the converter resolution as a parameter. The graph assumes the reference-voltage temperature coefficient as the only parameter affecting accuracy. In reality, the absolute static accuracy of a data converter is dependent on the combination of many parameters such as integral nonlinearity, differential nonlinearity, offset error, gain error, as well as voltage reference changes.

Turn-On Time

These devices turn on and settle to within 0.1% of their final value in less than 1ms. The turn-on time increases when heavily loaded and operating close to dropout.

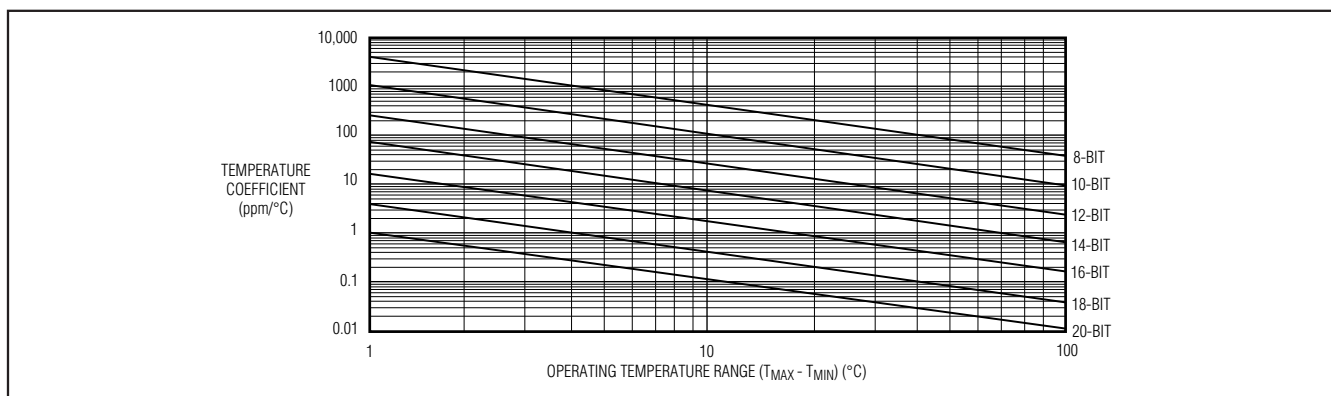
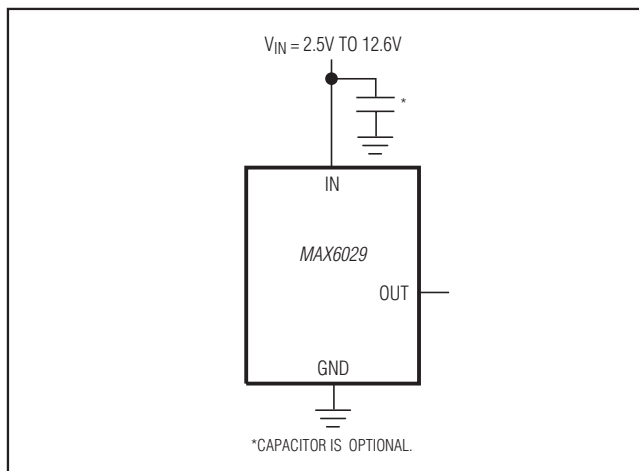

Figure 1. Temperature Coefficient vs. Operating Temperature Range for a 1LSB Maximum Error

Typical Operating Circuit



Chip Information

PROCESS: BiCMOS

Package Information

For the latest package outline information and land patterns (footprints), go to www.maximintegrated.com/packages. Note that a "+", "#", or "-" in the package code indicates RoHS status only. Package drawings may show a different suffix character, but the drawing pertains to the package regardless of RoHS status.

PACKAGE TYPE	PACKAGE CODE	OUTLINE NO.	LAND PATTERN NO.
5 SOT23	U5+1	21-0057	90-0174
8 SO	S8+2	21-0041	90-0096

Revision History

REVISION NUMBER	REVISION DATE	DESCRIPTION	PAGES CHANGED
0	7/03	Initial release	—
1	8/06	Added SO package	1, 2, 14, 15
2	11/06	Updated voltage output limits	3, 6
3	1/09	Added lead-free notation to <i>Ordering Information</i>	1

For pricing, delivery, and ordering information, please contact Maxim Direct at 1-888-629-4642, or visit Maxim Integrated's website at www.maximintegrated.com.

Maxim Integrated cannot assume responsibility for use of any circuitry other than circuitry entirely embodied in a Maxim Integrated product. No circuit patent licenses are implied. Maxim Integrated reserves the right to change the circuitry and specifications without notice at any time. The parametric values (min and max limits) shown in the Electrical Characteristics table are guaranteed. Other parametric values quoted in this data sheet are provided for guidance.



Компания «ЭлектроПласт» предлагает заключение долгосрочных отношений при поставках импортных электронных компонентов на взаимовыгодных условиях!

Наши преимущества:

- Оперативные поставки широкого спектра электронных компонентов отечественного и импортного производства напрямую от производителей и с крупнейших мировых складов;
- Поставка более 17-ти миллионов наименований электронных компонентов;
- Поставка сложных, дефицитных, либо снятых с производства позиций;
- Оперативные сроки поставки под заказ (от 5 рабочих дней);
- Экспресс доставка в любую точку России;
- Техническая поддержка проекта, помощь в подборе аналогов, поставка прототипов;
- Система менеджмента качества сертифицирована по Международному стандарту ISO 9001;
- Лицензия ФСБ на осуществление работ с использованием сведений, составляющих государственную тайну;
- Поставка специализированных компонентов (Xilinx, Altera, Analog Devices, Intersil, Interpoint, Microsemi, Aeroflex, Peregrine, Syfer, Eurofarad, Texas Instrument, Miteq, Cobham, E2V, MA-COM, Hittite, Mini-Circuits, General Dynamics и др.);

Помимо этого, одним из направлений компании «ЭлектроПласт» является направление «Источники питания». Мы предлагаем Вам помощь Конструкторского отдела:

- Подбор оптимального решения, техническое обоснование при выборе компонента;
- Подбор аналогов;
- Консультации по применению компонента;
- Поставка образцов и прототипов;
- Техническая поддержка проекта;
- Защита от снятия компонента с производства.



Как с нами связаться

Телефон: 8 (812) 309 58 32 (многоканальный)

Факс: 8 (812) 320-02-42

Электронная почта: org@eplast1.ru

Адрес: 198099, г. Санкт-Петербург, ул. Калинина, дом 2, корпус 4, литера А.