



Photocoupler
Product Data Sheet
4N35/ 4N37
(M, S, S-TA1)

Spec No. :DS-70-99-0012
Effective Date: 08/22/2017
Revision: E

LITE-ON DCC

RELEASE

BNS-OD-FC001/A4

Photocoupler 4N3X series

1. DESCRIPTION

1.1 Features

- Current transfer ratio (CTR : MIN. 100% at $I_F = 10\text{mA}$, $V_{CE} = 10\text{V}$, $T_a = 25^\circ\text{C}$)
- High input-output isolation voltage
4N35 series : $V_{iso} = 3,550\text{Vrms}$
4N37 series : $V_{iso} = 1,500\text{Vrms}$
- Response time (t_r : TYP. $3\mu\text{s}$ at $V_{CC} = 10\text{V}$, $I_C = 2\text{mA}$, $R_L = 100\Omega$)
- Dual-in-line package :
4N35, 4N37
- Wide lead spacing package :
4N35M, 4N37M
- Surface mounting package :
4N35S, 4N37S
- Tape and reel packaging :
4N35S-TA, 4N37S-TA, 4N35S-TA1, 4N37S-TA1
- Safety approval
* UL approved (No. E113898)
* CSA approved (No. CA91533-1)
* FIMKO approved (No. 193422-01)
* VDE approved (No. 40015248)
* BSI approved (No. 9018-9)
* CQC approved (No.CQC11001061921-2)
- Creepage distance > 8.0 mm ; Clearance > 8.0 mm
- The relevant models are the models Approved by VDE according to DIN EN 60747-5-5
Approved Model No.: 4N35-V / 4N37-V / 4N35M-V / 4N37M-V / 4N35S-V / 4N37S-V / 4N35STA-V / 4N37STA-V /
4N35STA1-V / 4N37STA1-V
VDE approved No.: 40015248 (According to the specification DIN EN 60747-5-5)
- Operating isolation voltage V_{IORM} : 420V (Peak)
- Transient voltage V_{TR} : 6000V (Peak)
- Pollution : 2 (According to VDE 0110-1 : 1997-04)
- Clearances distance (Between input and output) : 7.0mm (MIN.)
- Creepage distance (Between input and output) : 7.0mm (MIN.)
- Isolation thickness between input and output : 0.4mm (MIN.)
- Safety limit values Current (I_{si}) : 400mA (Diode side)
Power (P_{si}) : 700mW (Phototransistor side)
Temperature(T_{si}) : 175°C
In order to keep safety electric isolation of photocoupler, please set the protective circuit to keep within safety limit values when the actual application equipment troubled.
- Indication of VDE approval prints "" on sleeve package.

Photocoupler 4N3X series

- RoHS Compliance
All materials be used in device are followed EU RoHS directive (No.2002/95/EC).
- ESD pass HBM 8000V/MM2000V
- MSL class1

1.2 Applications

- Power Supply regulators
- Digital logic inputs
- Microprocessor inputs

Photocoupler 4N3X series

2. PACKAGE DIMENSIONS

2.1 4N35

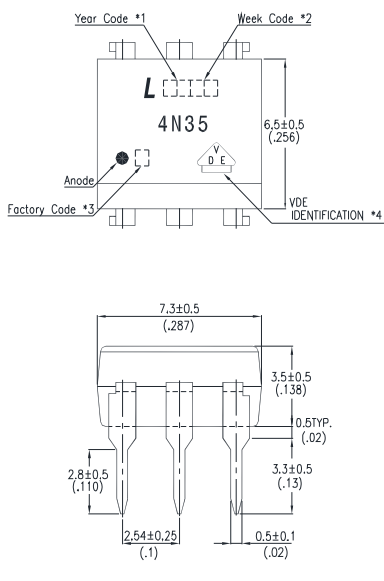

2.2 4N35M

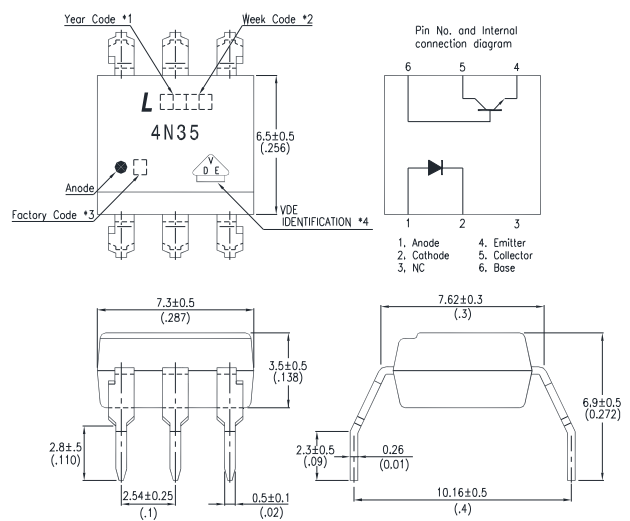

2.3 4N35S



Notes :

1. Year date code.
2. 2-digit work week.
3. Factory identification mark shall be marked (W: China-CZ, Y: Thailand X: China-TJ).
4. VDE option.

Dimensions in millimeters(inches).

Photocoupler 4N3X series

2.4 4N37

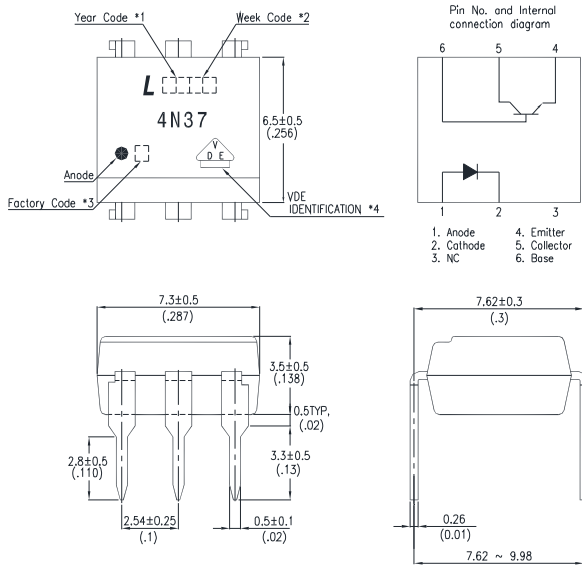

2.5 4N37M

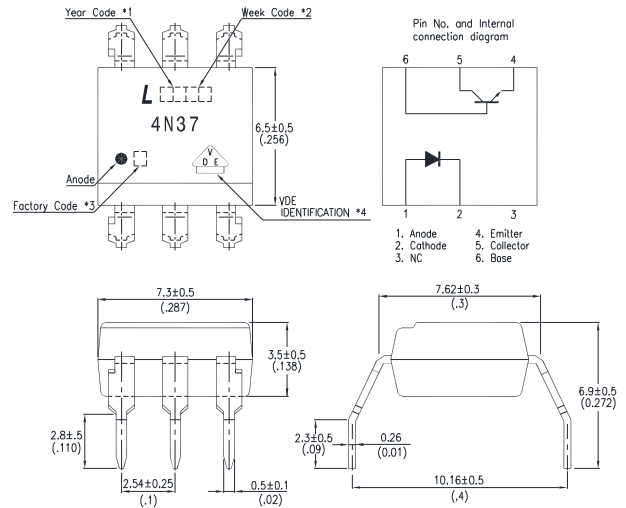

2.6 4N37S

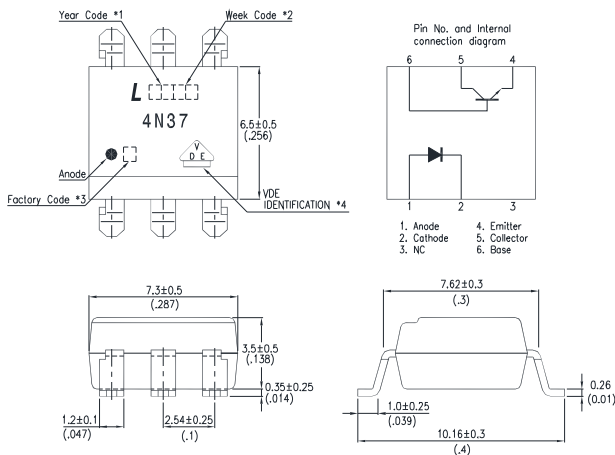

Notes :

1. Year date code.
2. 2-digit work week.
3. Factory identification mark shall be marked (W: China-CZ, Y: Thailand X: China-TJ).
4. VDE option.

Dimensions in millimeters(inches).

Photocoupler 4N3X series

3. TAPING DIMENSIONS

3.1 4N35S-TA, 4N37S-TA :



3.2 4N35S-TA1, 4N37S-TA1 :



Description	Symbol	Dimension in mm (inch)
Tape wide	W	16±0.3 (0.63)
Pitch of sprocket holes	P ₀	4±0.1 (0.15)
Distance of compartment	F	7.5±0.1 (0.295)
	P ₂	2±0.1 (0.079)
Distance of compartment to compartment	P ₁	12±0.1 (0.472)

3.3 Quantities Per Reel

Package Type	TA/TA1
Quantities (pcs)	1000

Photocoupler 4N3X series

4. RATING AND CHARACTERISTICS

4.1 Absolute Maximum Ratings at Ta=25°C

Parameter		Symbol	Rating	Unit
Input	Forward Current	I_F	60	mA
	Reverse Voltage	V_R	6	V
	Power Dissipation	P	100	mW
Output	Collector - Emitter Voltage	V_{CEO}	30	V
	Emitter - Collector Voltage	V_{ECO}	7	V
	Collector - Base Voltage	V_{CBO}	70	V
	Collector Current	I_C	100	mA
	Collector Power Dissipation	P_C	300	mW
Total Power Dissipation		P_{tot}	350	mW
*1 Isolation Voltage	4N35 series	V_{iso}	3,550	V_{rms}
	4N37 series		1,500	V_{rms}
Operating Temperature		T_{opr}	-55 ~ +100	°C
Storage Temperature		T_{stg}	-55 ~ +150	°C
*2 Soldering Temperature		T_{sol}	260	°C

*1. AC For 1 Minute, R.H. = 40 ~ 60%

Isolation voltage shall be measured using the following method.

- (1) Short between anode and cathode on the primary side and between collector and emitter on the secondary side.
- (2) The isolation voltage tester with zero-cross circuit shall be used.
- (3) The waveform of applied voltage shall be a sine wave.

*2. For 10 Seconds

Photocoupler 4N3X series

4.2 ELECTRICAL OPTICAL CHARACTERISTICS at Ta=25°C

PARAMETER		SYMBOL	MIN.	TYP.	MAX.	UNIT	CONDITIONS
INPUT	Forward Voltage	VF	—	1.2	1.5	V	IF=10mA
	Reverse Current	IR	—	—	10	μA	VR=4V
	Terminal Capacitance	Ct	—	50	—	pF	V=0, f=1KHz
OUTPUT	Collector Dark Current	ICEO	—	—	50	nA	VCE=10V, IF=0 Ta=25°C
			—	—	500	μA	VCE=30V, IF=0 Ta=100°C
	Collector-Emitter Breakdown Voltage	BVCEO	30	—	—	V	IC=0.1mA IF=0
	Emitter-Collector Breakdown Voltage	BVECO	7	—	—	V	IE=10μA IF=0
	Collector-Base Breakdown Voltage	BVCBO	70	—	—	V	IC=0.1mA IF=0
TRANSFER CHARACTERISTICS	Collector Current	IC	10	—	—	mA	IF=10mA
	*Current Transfer Ratio	CTR	100	—	—	%	VCE=10V
	Collector-Emitter Saturation Voltage	VCE(sat)	—	—	0.3	V	IF=50mA IC=2mA
	Isolation Resistance	Riso	5×10 ¹⁰	1×10 ¹¹	—	Ω	DC500V 40 ~ 60% R.H.
	Floating Capacitance	Cf	—	1	2.5	pF	V=0, f=1MHz
	Response Time (Rise)	tr	—	3	10	μs	VCE=10V, IC=2mA
	Response Time (Fall)	tf	—	3	10	μs	RL=100Ω

$$*CTR = \frac{I_C}{I_F} \times 100\%$$

Photocoupler 4N3X series

4.3 ISOLATION SPECIFICATION ACCORDING TO VDE

Parameter	Symbol	Conditions	Rating	Unit	Remark	
Class of environmental test	-	DIN IEC68	55/100/21	-		
Pollution	-	DIN VDE0110	2	-		
Maximum Operating Isolation Voltage	V_{IORM}	-	420	V_{PEAK}		
Partial Discharge Test Voltage (Between Input and Output)	Diagram 1	V_{pr}	$t_p=60s, q_c<5pC$	630	V_{PEAK}	Refer to the Diagram 1, 2
	Diagram 2		$t_p=1s, q_c<5pC$	788	V_{PEAK}	
Maximum Over-Voltage	$V_{INITIAL}$	$t_{NI} = 10s$	6000	V_{PEAK}		
Safety Maximum Ratings						
1) Case Temperature	T_{si}	$I_F = 0, P_c = 0$	175	°C	Refer to the Figure 1, 3	
2) Input Current	I_{si}	$P_c=0$	400	mA		
3) Electric Power (Output or Total Power Issipation)	P_{si}	-	700	mW		
Isolation Resistance (Test Voltage Between Input and Output : DC500V)	R_{ISO}	$T_a=T_{si}$	MIN.10 ⁹	Ω		
		$T_a=T_{opr}(MAX.)$	MIN.10 ¹¹			
		$T_a=25\text{ }^\circ\text{C}$	MIN.10 ¹²			

Precautions in performing isolation test

* Partial discharge test methods shall be the ones according to the specifications of DIN EN 60747-5-5

* Please don't carry out isolation test (V_{iso}) over $V_{INITIAL}$, This product deteriorates isolation characteristics by partial discharge due to applying high voltage (ex. $V_{INITIAL}$). And there is possibility that this product occurs partial discharge in operating isolation voltage (V_{IORM})

Photocoupler
4N3X series

4.4 PARTIAL DISCHARGE TEST METHOD

Method (A) for type testing and random testing.

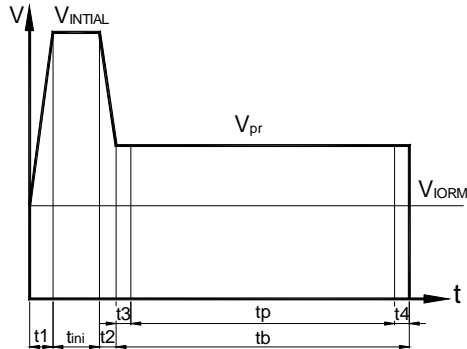

$t1, t2$ = 1 to 10s
 $t3, t4$ = 1s
 t_p (Partial Discharge Measuring Time) = 60s
 t_b = 62s
 t_{ini} = 10s

Method (B) for routine testing.

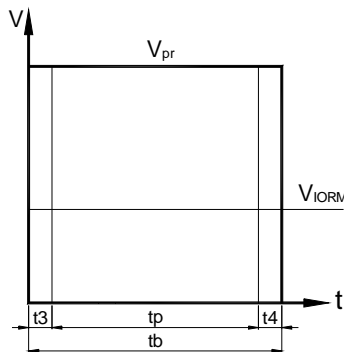

$t3, t4$ = 0.1s
 t_p (Partial Discharge Measuring Time) = 1s
 t_b = 1.2s

The partial discharge level shall not exceed 5 pc during the partial discharge measuring time interval t_p under the test conditions shown above.

Photocoupler 4N3X series

5. CHARACTERISTICS CURVES

Fig.1 Forward Current vs. Ambient Temperature

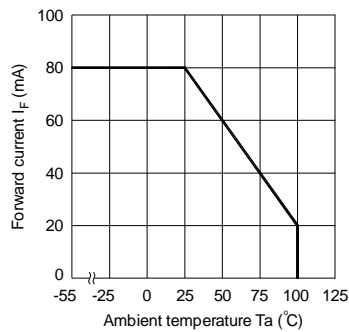

Fig.2 Collector Power Dissipation vs. Ambient Temperature



Fig.3 Forward Current vs. Forward Voltage

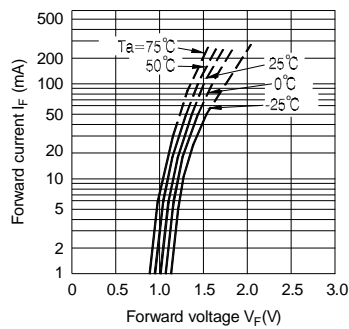

Fig.4 Current Transfer Ratio vs. Forward Current



Fig.5 Collector Current vs. Collector-emitter Voltage

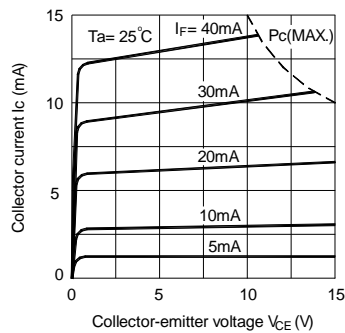
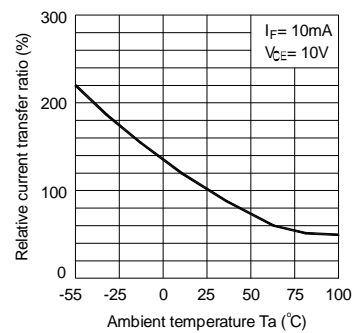

Fig.6 Relative Current Transfer Ratio vs. Ambient Temperature



Photocoupler 4N3X series

Fig.7 Collector-emitter Saturation Voltage vs. Ambient Temperature

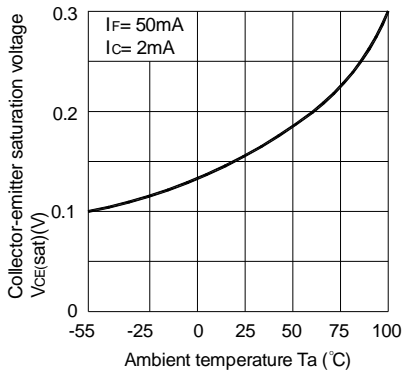

Fig.8 Collector Dark Current vs. Ambient Temperature

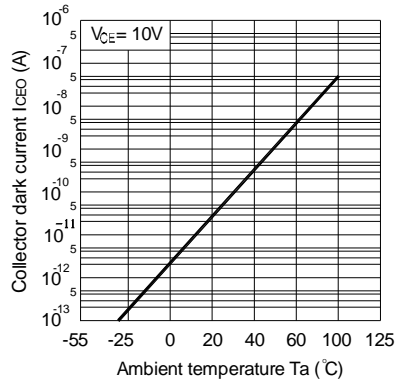

Fig.9 Response Time vs. Load Resistance

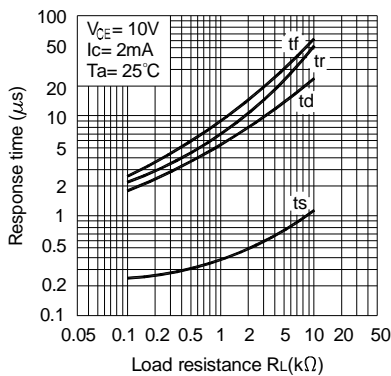

Fig.10 Frequency Response

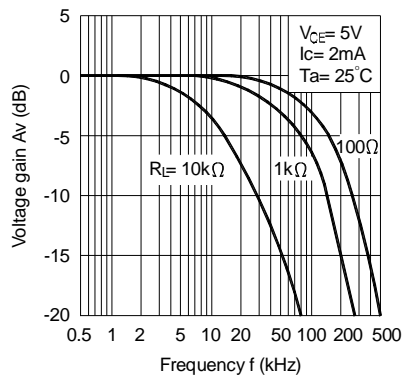
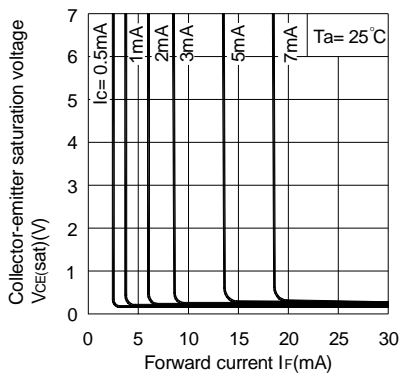
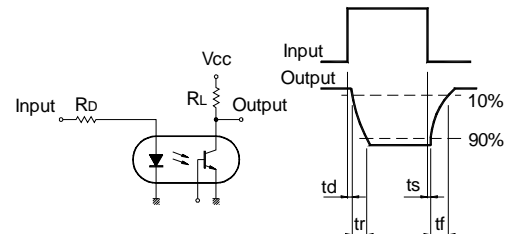

Fig.11 Collector-emitter Saturation Voltage vs. Forward Current



Test Circuit for Response Time



Test Circuit for Frequency Response

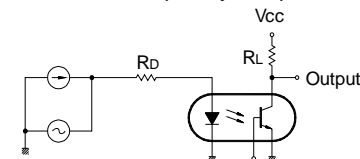

Photocoupler 4N3X series

6. TEMPERATURE PROFILE OF SOLDERING

6.1 IR Reflow soldering (JEDEC-STD-020C compliant)

One time soldering reflow is recommended within the condition of temperature and time profile shown below. Do not solder more than three times.

Profile item	Conditions
Preheat	
- Temperature Min (T_{Smin})	150°C
- Temperature Max (T_{Smax})	200°C
- Time (min to max) (t_s)	90±30 sec
Soldering zone	
- Temperature (T_L)	217°C
- Time (t_L)	60 sec
Peak Temperature (T_P)	260°C
Ramp-up rate	3°C / sec max.
Ramp-down rate	3~6°C / sec

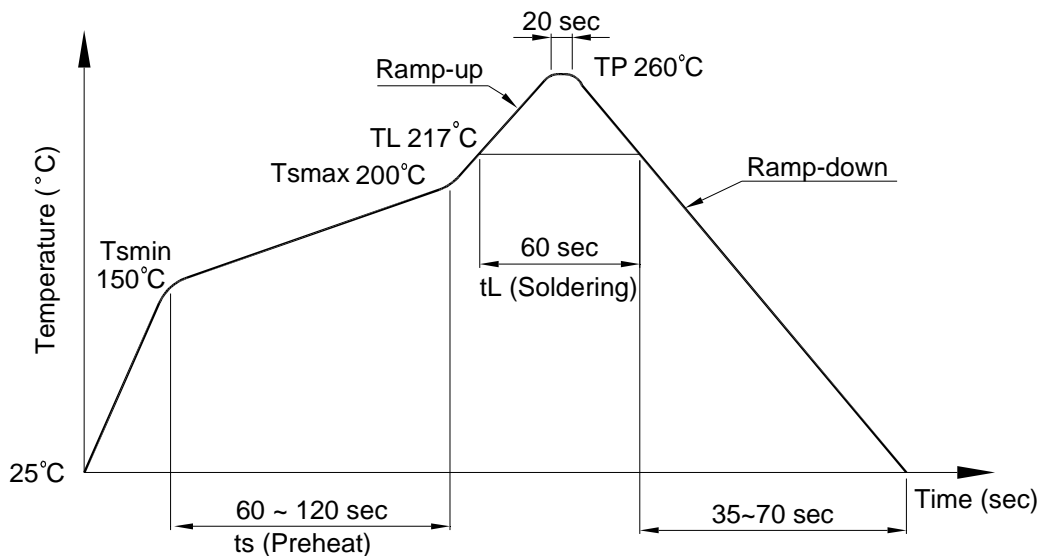

Photocoupler 4N3X series

6.2 Wave soldering (JEDEC22A111 compliant)

One time soldering is recommended within the condition of temperature.

Temperature: $260+0/-5^{\circ}\text{C}$

Time: 10 sec.

Preheat temperature: 25 to 140°C

Preheat time: 30 to 80 sec.



6.3 Hand soldering by soldering iron

Allow single lead soldering in every single process. One time soldering is recommended.

Temperature: $380+0/-5^{\circ}\text{C}$

Time: 3 sec max.

Photocoupler
4N3X series

7. RRECOMMENDED FOOT PRINT PATTERNS (MOUNT PAD)

Unit: mm

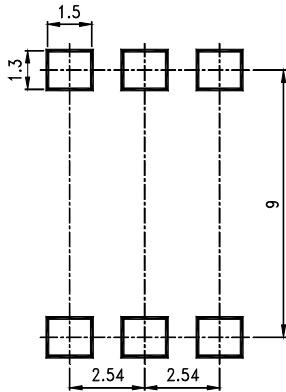

Photocoupler
4N3X series

8. Naming rule

4N3X (1)-(2)

DEVICE PART NUMBER

- (1) No suffix = Dual-in-Line package
- M = Wide lead spacing package
- S = Surface mounting package

- (2) TAPING TYPE (TA,TA1 or none)
- 4N3X series have tape and reel solution.
- Please refer to orientation of taping on Page P5

Example : 4N35S-TA1

4N3X(1)(2)-V

DEVICE PART NUMBER

- (1) No suffix = Dual-in-Line package
- M = Wide lead spacing package
- S = Surface mounting package

- (2) TAPING TYPE (TA,TA1 or none)
- 4N3X series have tape and reel solution.
- Please refer to orientation of taping on Page P5

- (3) VDE order option

Example : 4N35STA1-V-G

9. Notes:

- LiteOn is continually improving the quality, reliability, function or design and LiteOn reserves the right to make changes without further notices.
- The products shown in this publication are designed for the general use in electronic applications such as office automation equipment, communications devices, audio/visual equipment, electrical application and instrumentation.
- For equipment/devices where high reliability or safety is required, such as space applications, nuclear power control equipment, medical equipment, etc, please contact our sales representatives.
- When requiring a device for any "specific" application, please contact our sales in advice.
- If there are any questions about the contents of this publication, please contact us at your convenience.
- The contents described herein are subject to change without prior notice.
- Immerge unit's body in solder paste is not recommended.

Mouser Electronics

Authorized Distributor

Click to View Pricing, Inventory, Delivery & Lifecycle Information:

[Lite-On:](#)

[4N35S-TA1](#) [4N37S-TA](#) [4N35S-TA](#) [4N37S-TA1](#) [4N37M](#) [4N35M](#) [4N35](#) [4N37](#) [4N37S](#) [4N35S](#)



Компания «ЭлектроПласт» предлагает заключение долгосрочных отношений при поставках импортных электронных компонентов на взаимовыгодных условиях!

Наши преимущества:

- Оперативные поставки широкого спектра электронных компонентов отечественного и импортного производства напрямую от производителей и с крупнейших мировых складов;
- Поставка более 17-ти миллионов наименований электронных компонентов;
- Поставка сложных, дефицитных, либо снятых с производства позиций;
- Оперативные сроки поставки под заказ (от 5 рабочих дней);
- Экспресс доставка в любую точку России;
- Техническая поддержка проекта, помощь в подборе аналогов, поставка прототипов;
- Система менеджмента качества сертифицирована по Международному стандарту ISO 9001;
- Лицензия ФСБ на осуществление работ с использованием сведений, составляющих государственную тайну;
- Поставка специализированных компонентов (Xilinx, Altera, Analog Devices, Intersil, Interpoint, Microsemi, Aeroflex, Peregrine, Syfer, Eurofarad, Texas Instrument, Miteq, Cobham, E2V, MA-COM, Hittite, Mini-Circuits, General Dynamics и др.);

Помимо этого, одним из направлений компании «ЭлектроПласт» является направление «Источники питания». Мы предлагаем Вам помощь Конструкторского отдела:

- Подбор оптимального решения, техническое обоснование при выборе компонента;
- Подбор аналогов;
- Консультации по применению компонента;
- Поставка образцов и прототипов;
- Техническая поддержка проекта;
- Защита от снятия компонента с производства.



Как с нами связаться

Телефон: 8 (812) 309 58 32 (многоканальный)

Факс: 8 (812) 320-02-42

Электронная почта: org@eplast1.ru

Адрес: 198099, г. Санкт-Петербург, ул. Калинина, дом 2, корпус 4, литера А.