

Type 715P, Orange Drop[®], Polypropylene Film/Foil Capacitors

Features

- Long history of proven reliability
- Low dissipation factor.
- Tolerances as close as $\pm 1\%$.
- Excellent stability, virtually linear temperature coefficient.
- Various lead spacings, crimp styles and lead lengths available.

Specifications

Capacitance Range:

.001 μF to 0.47 μF

Capacitance Tolerance:

$\pm 1\%$ to $\pm 10\%$

Voltage Ratings:

100 to 2000 Volts D-C

70 to 500 Volts A-C

Operating Temperature Range:

-55°C to $+85^{\circ}\text{C}$

($+105^{\circ}\text{C}$ with proper voltage derating)

Lead Wire:

Tinned copper-clad steel,

.032 (0.8) diameter, #20 AWG

Dissipation Factor:

See tabulated data.

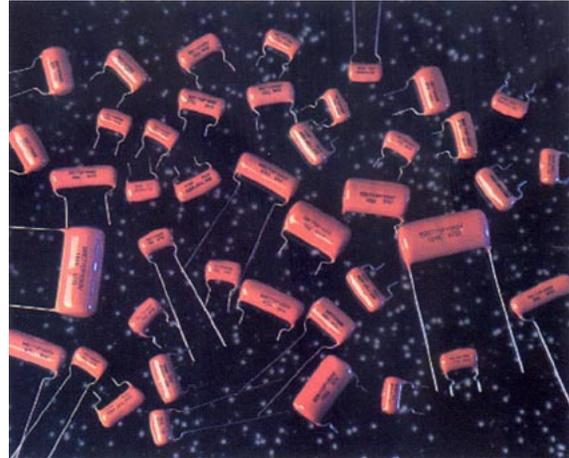

Insulation Resistance:

400,000 $\text{M}\Omega$ minimum at $+25^{\circ}\text{C}$

20,000 $\text{M}\Omega$ minimum at $+85^{\circ}\text{C}$

2,000 $\text{M}\Omega$ minimum at $+105^{\circ}\text{C}$

Pulse Rise Time, dV/dt :

See tabulated data.

Corona Start Voltage (typical):

See tabulated data.

Encapsulation:

Conformal coating of flame retardant orange epoxy (meets UL94V-0 specifications)

Dielectric:

Polypropylene film.

Construction:

Non-inductively wound with extended foil. Additional details on general specifications page.

Applications:

Switching and high voltage power supplies, inverters, snubbers, resonant converters and electronic lighting ballasts.

Dimensions in inches, metric (mm) in parenthesis.

General Specifications

The 715P and 716P series are manufactured with polypropylene film and extended foil. Polypropylene has a very low dissipation factor, low dielectric absorption and exhibits excellent capacitance stability. These characteristics combined with the direct connection of the lead wire to the extended foil electrode makes the 715P and 716P series ideal for high current, high pulse applications.

The 715P series has a round profile and is available in tolerances as close as $\pm 1\%$. The 716P series has a pressed profile and, in addition, is designed with copper leads, thus adding to its performance in high frequency, high pulse current applications.

Other specifications are listed below and on the following pages.

Operating Temperature Range:

The standard operating temperature range for polypropylene film is -55°C to $+85^{\circ}\text{C}$. The 715P and 716P may be operated up to $+105^{\circ}\text{C}$ provided the DC working voltage is reduced by 50%.

For specific derating of the AC voltage when operating above $+85^{\circ}\text{C}$ please contact our design engineering department.

The maximum operating temperature for 715P and 716P polypropylene film capacitors is $+105^{\circ}\text{C}$.

Dielectric Withstanding Voltage:

Units rated below 800 VDC shall withstand a DC potential of 250% of rated voltage applied between terminals for not more than 5 seconds; units rated 800 VDC and above shall withstand 200% of rated voltage.

Construction:

Units rated 100 through 600 VDC are single section designs constructed of plain polypropylene film with extended foil. Units rated 800 VDC and above are series-section designs with extended foil and incorporate a floating common of metallized polypropylene. All units are non-inductively wound.

Temperature Coefficient:

The typical temperature coefficient is $-180 \text{ ppm}/^{\circ}\text{C}$ over the temperature range of -55°C to $+85^{\circ}\text{C}$.

Humidity Testing:

Units subjected to 95% relative humidity for 72 hours with no voltage applied at $+75^{\circ}\text{C}$. After 4 hours of drying minimum product of insulation resistance and capacitance shall be 50,000 megohm-microfarads.

DC Voltage Life Test:

Minimum of 500 hours at $+85^{\circ}\text{C}$ at 150% of rated voltage. After test, capacitance shall not have changed by more than 3%, insulation resistance shall not have decreased by more than 25% and dissipation factor shall not have changed by more than 0.03%. Measurements made at 1 KHz.

AC Voltage Life Test:

Minimum of 500 hours at $+85^{\circ}\text{C}$ at 60 Hz. AC test voltage applied at 110% of AC rating. After test, capacitance shall not have changed by more than 3%, insulation resistance shall not have decreased by more than 25%, and dissipation factor shall not have changed by more than 0.03%. Measurements made at 1 KHz.

Additional notes on Life Testing:

CDE performs standard 500 hour accelerated life tests, both DC and line frequency AC, to monitor process control over our wide range of products.

We also perform longer term life testing, typically 2000 hours, during development of most products. In addition we do accelerated life testing at 10-250 KHz for our High Performance AC products. For additional life test information please contact us.

Type 715P, Orange Drop[®], Polypropylene Film/Foil Capacitors

Ordering/Part Number Information

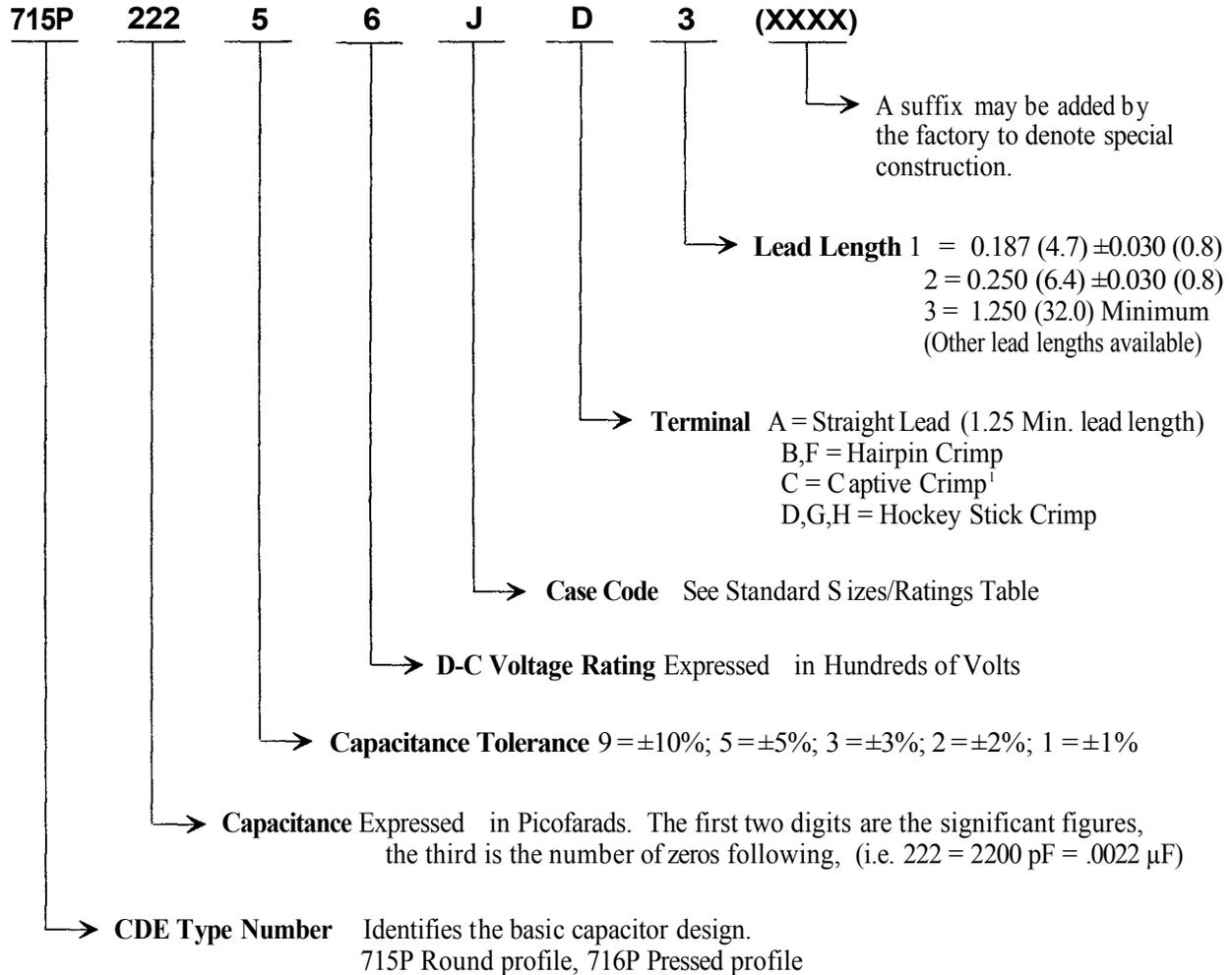

¹Terminal C has a fixed lead length of 0.156 (4.0) ±0.020 (0.5), therefore it is not necessary to indicate the lead length digit when ordering. Available for "L" case code parts only

Please note:

While it is not possible to list every capacitance value, tolerance, or design/size variation available, our flexibility in design and manufacturing gives us the ability to quickly, and cost effectively, provide you with the capacitor you require. Please contact us today with your specific needs!

Dimensions in inches, metric (mm) in parenthesis.

Type 715P, Orange Drop[®], Polypropylene Film/Foil Capacitors

Standard Lead Styles

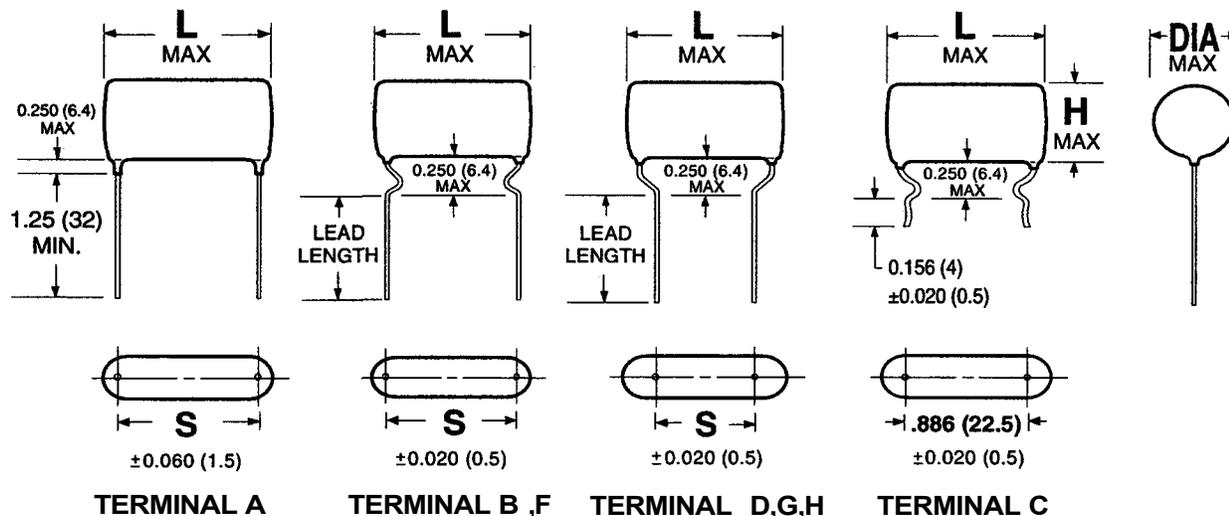

Standard Lead Spacings

CASE CODE	S, inches (metric, mm in parentheses)						
	Term. A	Term. B	Term. D	Term. C*	Term. F	Term. G	Term. H
N	0.394 (10)	0.394 (10)	---	---	0.295 (7.5)	0.197 (5)	---
J	0.500 (12.7)	0.500 (12.7)	0.375 (9.5)	---	0.394 (10)	0.295 (7.5)	0.197 (5)
K	0.688 (17.5)	0.688 (17.5)	0.375 (9.5)	---	0.590 (15)	0.394 (10)	0.295 (7.5)
L	1.031 (26.2)	0.969 (24.6)	0.719 (18.3)	0.886 (22.5)	0.886 (22.5)	0.590 (15)	---
M	1.406 (35.7)	1.344 (34.1)	1.094 (27.8)	---	---	1.083 (27.5)	---

* Terminal C is designed for printed circuit boards requiring a lead spacing of 0.886 (22.5) with board hole sizes of 0.044 (1.1) to 0.048 (1.2) in diameter. Available for "L" case code parts only. Please consult us if you have a specific requirement.

Standard Marking Format

Sample Marking on unit

CDE715P600V
222J 9810

Description

CDE - CDE Electronics identification
715P - Type number
600V - D-C Voltage rating, Volts
222J - Capacitance and tolerance code
9810 - Weekly date code
(i.e. 10th week of 1998)

Tolerance codes per EIA Standards

F ±1%
G ±2%
H ±3%
J ±5%
K ±10%

Dimensions in inches, metric (mm) in parenthesis.

Type 715P, Orange Drop®, Polypropylene Film/Foil Capacitors

Type 715P Standard Sizes/Ratings¹

Value, μ F	PartNumber ²	L MAX	DIA MAX	H MAX	Value, μ F	PartNumber ²	L MAX	DIA MAX	H MAX
100 VDC / 70 VAC*					200 VDC / 155 VAC*				
.0056	715P56291N	.57 (14.5)	.25 (6.4)	.31 (7.9)	.082	715P82392L	1.25 (31.8)	.36 (9.1)	.42 (10.7)
.006	715P60291N	.57 (14.5)	.25 (6.4)	.31 (7.9)	.1	715P10492L	1.25 (31.8)	.38 (9.7)	.44 (11.2)
.0068	715P68291N	.57 (14.5)	.26 (6.6)	.32 (8.1)	.12	715P12492L	1.25 (31.8)	.41 (10.4)	.47 (11.9)
.0075	715P75291N	.57 (14.5)	.26 (6.6)	.32 (8.1)	.15	715P15492L	1.25 (31.8)	.44 (11.2)	.5 (12.7)
.0082	715P82291N	.57 (14.5)	.27 (6.9)	.33 (8.4)	.18	715P18492L	1.25 (31.8)	.47 (11.9)	.53 (13.5)
.009	715P90291N	.57 (14.5)	.26 (6.6)	.32 (8.1)	.22	715P22492L	1.25 (31.8)	.51 (13.0)	.57 (14.5)
.01	715P10391N	.57 (14.5)	.26 (6.6)	.32 (8.1)	.27	715P27492M	1.65 (41.9)	.49 (12.4)	.55 (14.0)
.012	715P12391N	.57 (14.5)	.28 (7.1)	.34 (8.6)	.33	715P33492M	1.65 (41.9)	.53 (13.5)	.59 (15.0)
.015	715P15391N	.57 (14.5)	.29 (7.4)	.35 (8.9)	.39	715P39492M	1.65 (41.9)	.56 (14.2)	.62 (15.7)
.018	715P18391N	.57 (14.5)	.31 (7.9)	.37 (9.4)	.47	715P47492M	1.65 (41.9)	.60 (15.2)	.66 (16.8)
.022	715P22391N	.57 (14.5)	.33 (8.4)	.39 (9.9)	400 VDC / 200 VAC*				
.025	715P25391N	.57 (14.5)	.35 (8.9)	.41 (10.4)	.001	715P10294J	.70 (17.8)	.35 (8.9)	.39 (9.9)
.027	715P27391N	.57 (14.5)	.35 (8.9)	.41 (10.4)	.0012	715P12294J	.70 (17.8)	.36 (9.1)	.40 (10.2)
.033	715P33391N	.57 (14.5)	.38 (9.7)	.44 (11.2)	.0015	715P15294J	.70 (17.8)	.32 (8.1)	.36 (9.1)
.039	715P39391J	.70 (17.8)	.34 (8.6)	.40 (10.2)	.0018	715P18294J	.70 (17.8)	.34 (8.6)	.38 (9.7)
.047	715P47391J	.70 (17.8)	.36 (9.1)	.42 (10.7)	.0022	715P22294J	.70 (17.8)	.33 (8.4)	.37 (9.4)
.05	715P50391J	.70 (17.8)	.37 (9.4)	.43 (10.9)	.0027	715P27294J	.70 (17.8)	.35 (8.9)	.39 (9.9)
.056	715P56391J	.70 (17.8)	.38 (9.7)	.44 (11.2)	.0033	715P33294J	.70 (17.8)	.32 (8.1)	.36 (9.1)
.062	715P62291J	.70 (17.8)	.40 (10.2)	.46 (11.7)	.0039	715P39294J	.70 (17.8)	.34 (8.6)	.38 (9.7)
.068	715P68391J	.70 (17.8)	.41 (10.4)	.47 (11.9)	.0047	715P47294J	.70 (17.8)	.34 (8.6)	.38 (9.7)
.075	715P75391K	.90 (22.9)	.36 (9.1)	.42 (10.7)	.0056	715P56294J	.70 (17.8)	.36 (9.1)	.40 (10.2)
.082	715P82391K	.90 (22.9)	.37 (9.4)	.43 (10.9)	.0068	715P68294J	.70 (17.8)	.29 (7.4)	.35 (8.9)
.09	715P90391K	.90 (22.9)	.38 (9.7)	.44 (11.2)	.0082	715P82294J	.70 (17.8)	.30 (7.6)	.36 (9.1)
.1	715P10491K	.90 (22.9)	.40 (10.2)	.46 (11.7)	.01	715P10394J	.70 (17.8)	.30 (7.6)	.36 (9.1)
.12	715P12491K	.90 (22.9)	.43 (10.9)	.49 (11.9)	.012	715P12394J	.70 (17.8)	.32 (8.1)	.38 (9.7)
.15	715P15491K	.90 (22.9)	.46 (11.7)	.52 (13.2)	.015	715P15394J	.70 (17.8)	.34 (8.6)	.40 (10.2)
.18	715P18491K	.90 (22.9)	.50 (12.7)	.56 (14.2)	.018	715P18394K	.90 (22.9)	.31 (7.9)	.37 (9.4)
.2	715P20491K	.90 (22.9)	.52 (13.2)	.58 (14.7)	.022	715P22394K	.90 (22.9)	.33 (8.4)	.39 (9.9)
.22	715P22491K	.90 (22.9)	.54 (13.7)	.60 (15.2)	.027	715P27394K	.90 (22.9)	.36 (9.1)	.42 (10.7)
.25	715P25491L	1.25 (31.8)	.47 (11.9)	.53 (13.5)	.033	715P33394K	.90 (22.9)	.38 (9.7)	.44 (11.2)
.27	715P27491L	1.25 (31.8)	.48 (12.2)	.54 (13.7)	.039	715P39394L	1.25 (31.8)	.35 (8.9)	.41 (10.4)
.3	715P30491L	1.25 (31.8)	.50 (12.7)	.56 (14.2)	.047	715P47394L	1.25 (31.8)	.37 (9.4)	.43 (10.9)
.33	715P33491L	1.25 (31.8)	.52 (13.2)	.58 (14.7)	.056	715P56394L	1.25 (31.8)	.39 (9.9)	.45 (11.4)
200 VDC / 155 VAC*					.068	715P68394L	1.25 (31.8)	.42 (10.7)	.48 (12.2)
.01	715P10392J	.70 (17.8)	.25 (6.4)	.31 (7.9)	.082	715P82394L	1.25 (31.8)	.45 (11.4)	.51 (13.0)
.012	715P12392J	.70 (17.8)	.26 (6.6)	.32 (8.1)	.1	715P10494L	1.25 (31.8)	.48 (12.2)	.54 (13.7)
.015	715P15392J	.70 (17.8)	.28 (7.1)	.34 (8.6)	.12	715P12494L	1.25 (31.8)	.52 (13.2)	.58 (14.7)
.018	715P18392J	.70 (17.8)	.29 (7.4)	.35 (8.9)	.15	715P15494L	1.25 (31.8)	.56 (14.2)	.62 (15.7)
.022	715P22392J	.70 (17.8)	.31 (7.9)	.37 (9.4)	.18	715P18494M	1.65 (41.9)	.54 (13.7)	.60 (15.2)
.027	715P27392J	.70 (17.8)	.33 (8.4)	.39 (9.9)	.22	715P22494M	1.65 (41.9)	.58 (14.7)	.64 (16.3)
.033	715P33392J	.70 (17.8)	.36 (9.1)	.42 (10.7)	.27	715P27494M	1.65 (41.9)	.63 (16.0)	.69 (17.5)
.039	715P39392K	.90 (22.9)	.32 (8.1)	.38 (9.7)	.33	715P33494M	1.65 (41.9)	.70 (17.8)	.76 (19.3)
.047	715P47392K	.90 (22.9)	.34 (8.6)	.40 (10.2)	.39	715P39494M	1.65 (41.9)	.75 (19.1)	.81 (20.6)
.056	715P56392K	.90 (22.9)	.37 (9.4)	.43 (10.9)	.47	715P47494M	1.65 (41.9)	.82 (20.8)	.88 (22.4)
.068	715P68392K	.90 (22.9)	.39 (9.9)	.45 (11.4)					

¹ Shaded part numbers, when ordered as $\pm 5\%$ tolerance with D3 leads, are standard stock items available through the CDE Distribution Network. F or complete part number add letter and number for terminal style and lead length in accordance with Ordering Information, (i.e. 715P10452LD3)

² To complete part number for proper tolerance, terminal style and lead length please refer to Ordering/Part Number Information page.

* Please refer to performance curves for RMS Voltage vs. Frequency characteristics.

Dimensions in inches, metric (mm) in parenthesis.

Type 715P, Orange Drop®, Polypropylene Film/Foil Capacitors

Type 715P Standard Sizes/Ratings¹

Value, μ F	Part Number ²	L MAX	DIA MAX	H MAX	Value, μ F	Part Number	L MAX	DIA MAX	H MAX
600 VDC / 2 00 VAC*					1000 VDC / 4 50 VAC*				
.001	715P10296J	.70 (17.8)	.35 (8.9)	.39 (9.9)	.0056	715P562910L	1.25 (31.8)	.28 (7.1)	.34 (8.6)
.0012	715P12296J	.70 (17.8)	.36 (9.1)	.40 (10.2)	.0068	715P682910L	1.25 (31.8)	.29 (7.4)	.35 (8.9)
.0015	715P15296J	.70 (17.8)	.32 (8.1)	.36 (9.1)	.0082	715P822910L	1.25 (31.8)	.31 (7.9)	.37 (9.4)
.0018	715P18296J	.70 (17.8)	.34 (8.6)	.38 (9.7)	.01	715P103910L	1.25 (31.8)	.33 (8.4)	.39 (3.9)
.0022	715P22296J	.70 (17.8)	.33 (8.4)	.37 (9.4)	.012	715P123910L	1.25 (31.8)	.35 (8.9)	41 (10.4)
.0027	715P27296J	.70 (17.8)	.35 (8.9)	.39 (9.9)	.015	715P153910L	1.25 (31.8)	.38 (9.7)	44 (11.2)
.0033	715P33296J	.70 (17.8)	.32 (8.1)	.36 (9.1)	.018	715P183910L	1.25 (31.8)	41 (10.4)	47 (11.9)
.0039	715P39296J	.70 (17.8)	.34 (8.6)	.38 (9.7)	.022	715P223910L	1.25 (31.8)	44 (11.2)	50 (12.7)
.0047	715P47296J	.70 (17.8)	.34 (8.6)	.38 (9.7)	.027	715P273910L	1.25 (31.8)	47 (11.9)	53 (13.5)
.0056	715P56296J	.70 (17.8)	.36 (9.1)	40 (10.2)	.033	715P333910L	1.25 (31.8)	.51 (13.0)	.57 (14.5)
.0068	715P68296J	.70 (17.8)	.38 (9.7)	42 (10.7)	.039	715P393910M	1.65 (41.9)	47 (11.9)	53 (13.5)
.0082	715P82296K	.90 (22.9)	.34 (8.6)	.38 (9.7)	.047	715P473910M	1.65 (41.9)	.50 (12.7)	.56 (14.2)
.01	715P10396K	.90 (22.9)	.36 (9.1)	40 (10.2)	.056	715P563910M	1.65 (41.9)	.53 (13.5)	.59 (15.0)
.012	715P12396K	.90 (22.9)	.38 (9.7)	42 (10.7)	.068	715P683910M	1.65 (41.9)	.58 (14.7)	.64 (16.3)
.015	715P15396K	.90 (22.9)	42 (10.7)	46 (11.7)	.082	715P823910M	1.65 (41.9)	.62 (15.7)	.68 (17.3)
.018	715P18396K	.90 (22.9)	44 (11.2)	48 (12.2)	.1	715P104910M	1.65 (41.9)	.67 (17.0)	.73 (18.5)
.022	715P22396K	.90 (22.9)	48 (12.2)	.52 (13.2)	1200 VDC / 4 75 VAC*				
.027	715P27396L	1.25 (31.8)	43 (10.2)	47 (11.9)	.001	715P102912L	1.25 (31.8)	.29 (7.4)	.33 (8.4)
.033	715P33396L	1.25 (31.8)	46 (11.7)	.50 (12.7)	.0012	715P122912L	1.25 (31.8)	.30 (7.6)	.34 (8.6)
.039	715P39396L	1.25 (31.8)	49 (12.4)	.53 (13.5)	.0015	715P152912L	1.25 (31.8)	.32 (8.1)	.36 (9.1)
.047	715P47396L	1.25 (31.8)	.52 (13.2)	.56 (14.2)	.0018	715P182912L	1.25 (31.8)	.34 (8.6)	.38 (9.7)
.056	715P56396L	1.25 (31.8)	.56 (14.2)	.60 (15.2)	.0022	715P222912L	1.25 (31.8)	.35 (8.9)	.39 (9.9)
.068	715P68396L	1.25 (31.8)	.60 (15.2)	.64 (16.3)	.0027	715P272912L	1.25 (31.8)	.38 (9.7)	42 (10.7)
.082	715P82396L	1.25 (31.8)	.65 (16.5)	.69 (17.5)	.0033	715P332912L	1.25 (31.8)	.32 (8.1)	.38 (9.7)
.1	715P10496L	1.25 (31.8)	.71 (18.0)	.75 (19.2)	.0039	715P392912L	1.25 (31.8)	.34 (8.6)	40 (10.2)
.12	715P12496M	1.65 (41.9)	.65 (16.5)	.69 (17.5)	.0047	715P472912L	1.25 (31.8)	.36 (9.1)	42 (10.7)
.15	715P15496M	1.65 (41.9)	.71 (18.0)	.75 (19.1)	.0056	715P562912L	1.25 (31.8)	.38 (9.7)	44 (11.2)
.18	715P18496M	1.65 (41.9)	.77 (19.6)	.81 (20.6)	.0068	715P682912L	1.25 (31.8)	41 (10.4)	47 (11.9)
.22	715P22496M	1.65 (41.9)	.83 (21.1)	.85 (21.6)	.0082	715P822912L	1.25 (31.8)	44 (11.2)	50 (12.7)
800 VDC / 4 50 VAC*					.01	715P103912L	1.25 (31.8)	47 (11.9)	53 (13.5)
.0056	715P56298L	1.25 (31.8)	.28 (7.1)	.34 (8.6)	.012	715P123912L	1.25 (31.8)	.51 (13.0)	.57 (14.5)
.0068	715P68298L	1.25 (31.8)	.29 (7.4)	.35 (8.9)	.015	715P153912L	1.25 (31.8)	.55 (14.0)	.61 (15.5)
.0082	715P82298L	1.25 (31.8)	.31 (7.9)	.37 (9.4)	.018	715P183912M	1.65 (41.9)	.50 (12.7)	.56 (14.2)
.01	715P10398L	1.25 (31.8)	.33 (8.4)	.39 (9.9)	.022	715P223912M	1.65 (41.9)	.54 (13.7)	.60 (15.2)
.012	715P12398L	1.25 (31.8)	.35 (8.9)	41 (10.4)	.027	715P273912M	1.65 (41.9)	.59 (15.0)	.65 (16.5)
.015	715P15398L	1.25 (31.8)	.38 (9.7)	44 (11.2)	.033	715P333912M	1.65 (41.9)	.64 (16.3)	.70 (17.8)
.018	715P18398L	1.25 (31.8)	41 (10.4)	47 (11.9)	.039	715P393912M	1.65 (41.9)	.68 (17.3)	.74 (18.8)
.022	715P22398L	1.25 (31.8)	44 (11.2)	50 (12.7)	.047	715P473912M	1.65 (41.9)	.74 (18.8)	80 (20.3)
.027	715P27398L	1.25 (31.8)	47 (11.9)	53 (13.5)	.0068	715P682912L	1.25 (31.8)	41 (10.4)	47 (11.9)
.033	715P33398L	1.25 (31.8)	.51 (13.0)	.57 (14.5)	.0082	715P822912L	1.25 (31.8)	44 (11.2)	50 (12.7)
.039	715P39398M	1.65 (41.9)	47 (11.9)	53 (13.5)	.01	715P103912L	1.25 (31.8)	47 (11.9)	53 (13.5)
.047	715P47398M	1.65 (41.9)	50 (12.7)	56 (14.2)	.012	715P123912L	1.25 (31.8)	.51 (13.0)	.57 (14.5)
.056	715P56398M	1.65 (41.9)	.53 (13.5)	.59 (15.0)	.015	715P153912L	1.25 (31.8)	.55 (14.0)	.61 (15.5)
.068	715P68398M	1.65 (41.9)	.58 (14.7)	.64 (16.3)	.018	715P183912M	1.65 (41.9)	.50 (12.7)	.56 (14.2)
.082	715P82398M	1.65 (41.9)	.62 (15.7)	.68 (17.3)	.022	715P223912M	1.65 (41.9)	.54 (13.7)	.60 (15.2)
.1	715P10498M	1.65 (41.9)	.67 (17.0)	.73 (18.5)	.027	715P273912M	1.65 (41.9)	.59 (15.0)	.65 (16.5)

¹ Shaded part numbers, when ordered as $\pm 5\%$ tolerance with D3 leads, are standard stock items available through the CDE Distribution Network. For complete part number add letter and number for terminal style and lead length in accordance with Ordering Information, (i.e. 715P10452LD3)

² To complete part number for proper tolerance, terminal style and lead length please refer to Ordering/Part Number Information page.

* Please refer to performance curves for RMS Voltage vs. Frequency characteristics.

Dimensions in inches, metric (mm) in parenthesis.

Type 715P, Orange Drop[®], Polypropylene Film/Foil Capacitors

Type 715P Standard Sizes/Ratings¹

Value, μ F	Part Number ²	L MAX	DIA MAX	H MAX	Value, μ F	Part Number ²	L MAX	DIA MAX	H MAX
1600 VDC / 500 VAC*					2000 VDC / 500 VAC*				
.001	715P102916L	1.25 (31.8)	.29 (7.4)	.33 (8.4)	.001	715P102920L	1.25 (31.8)	.29 (7.4)	.33 (8.4)
.0012	715P122916L	1.25 (31.8)	.30 (7.6)	.34 (8.6)	.0012	715P122920L	1.25 (31.8)	.30 (7.6)	.34 (8.6)
.0015	715P152916L	1.25 (31.8)	.32 (8.1)	.36 (9.1)	.0015	715P152920L	1.25 (31.8)	.32 (8.1)	.36 (9.1)
.0018	715P182916L	1.25 (31.8)	.34 (8.6)	.38 (9.7)	.0018	715P182920L	1.25 (31.8)	.34 (8.6)	.38 (9.7)
.0022	715P222916L	1.25 (31.8)	.35 (8.9)	.39 (9.9)	.0022	715P222920L	1.25 (31.8)	.35 (8.9)	.39 (9.9)
.0027	715P272916L	1.25 (31.8)	.38 (9.7)	.42 (10.7)	.0027	715P272920L	1.25 (31.8)	.38 (9.7)	.42 (10.7)
.0033	715P332916L	1.25 (31.8)	.40 (10.2)	.44 (11.2)	.0033	715P332920L	1.25 (31.8)	.40 (10.2)	.44 (11.2)
.0039	715P392916L	1.25 (31.8)	.43 (10.9)	.47 (11.9)	.0039	715P392920L	1.25 (31.8)	.43 (10.9)	.47 (11.9)
.0047	715P472916L	1.25 (31.8)	.46 (11.7)	.50 (12.7)	.0047	715P472920L	1.25 (31.8)	.46 (11.7)	.50 (12.7)
.0056	715P562916L	1.25 (31.8)	.49 (12.4)	.53 (13.5)	.0056	715P562920L	1.25 (31.8)	.49 (12.4)	.53 (13.5)
.0068	715P682916L	1.25 (31.8)	.52 (13.2)	.56 (14.2)	.0068	715P682920L	1.25 (31.8)	.52 (13.2)	.56 (14.2)
.0082	715P822916L	1.25 (31.8)	.56 (14.2)	.60 (15.2)	.0082	715P822920L	1.25 (31.8)	.56 (14.2)	.60 (15.2)
.01	715P103916L	1.25 (31.8)	.61 (15.5)	.65 (16.5)	.01	715P103920L	1.25 (31.8)	.61 (15.5)	.65 (16.5)
.012	715P123916M	1.65 (41.9)	.54 (13.7)	.58 (14.7)	.012	715P123920M	1.65 (41.9)	.54 (13.7)	.58 (14.7)
.015	715P153916M	1.65 (41.9)	.59 (15.0)	.63 (16.0)	.015	715P153920M	1.65 (41.9)	.59 (15.0)	.63 (16.0)
.018	715P183916M	1.65 (41.9)	.63 (16.0)	.67 (17.0)	.018	715P183920M	1.65 (41.9)	.63 (16.0)	.67 (17.0)
.022	715P223916M	1.65 (41.9)	.69 (17.5)	.73 (18.5)	.022	715P223920M	1.65 (41.9)	.69 (17.5)	.73 (18.5)
.027	715P273916M	1.65 (41.9)	.74 (18.8)	.78 (19.8)	.027	715P273920M	1.65 (41.9)	.74 (18.8)	.78 (19.8)
.033	715P333916M	1.65 (41.9)	.81 (20.6)	.85 (21.6)	.033	715P333920M	1.65 (41.9)	.81 (20.6)	.85 (21.6)

¹ Shaded part numbers, when ordered as $\pm 5\%$ tolerance with D3 leads, are standard stock items available through the CDE Distribution Network. For complete part number add letter and number for terminal style and lead length in accordance with Ordering Information, (i.e. 715P10452LD3)

² To complete part number for proper tolerance, terminal style and lead length please refer to Ordering/Part Number Information page.

* Please refer to performance curves for RMS Voltage vs. Frequency characteristics.

Please note:

It is not possible to list every capacitance value available for each rating, if you require a specific cap value not listed just give us a call. We will supply the details you need.

Dimensions in inches, metric (mm) in parenthesis.

Type 715P, Orange Drop[®], Polypropylene Film/Foil Capacitors

Corona, Dissipation Factor Specifications

Corona Start Voltage

D-C Rating	Typical Corona Start Voltage, RMS
100	250
200	300
400, 600	325
800, 1000	600
1200	625
1600, 2000	650

Maximum Dissipation Factor (D.F.) in %

Cap Range (µF)	100V-600V		800V/1000V		1200V		1600V/2000V	
	20KHz	100KHz	20KHz	100KHz	20KHz	100KHz	20KHz	100KHz
.001 - .01	.029	.040	.039	.088	.035	.068	.033	.059
.012 - .022	.031	.050	.040	.098	.043	.111	.039	.093
.027 - .047	.034	.071	.055	.175	.047	.132	.041	.102
.056 - .068	.037	.089	.058	.193	--	--	--	--
.082 - .1	.042	.116	.063	.220	--	--	--	--
.12 - .15	.049	.158	--	--	--	--	--	--
.18 - .22	.059	.217	--	--	--	--	--	--
.27 - .33	.074	.309	--	--	--	--	--	--
.39 - .47	.093	.427	--	--	--	--	--	--

Type 715P, Orange Drop[®], Polypropylene Film/Foil Capacitors

dV/dt Specifications

Maximum Pulse Rise Time (dV/dt) in Volts/μsec

Cap Value (μF)	100V	200V	400V	600V	800V/ 1000V	1200V	1600V/ 2000V
.001	-	-	19900	19900	-	43200	43200
.0012	-	-	18200	18200	-	39500	39500
.0015	-	-	16200	16200	-	35300	35300
.0018	-	-	14800	14800	-	32200	32200
.0022	-	-	13400	13400	-	29100	29100
.0027	-	-	12100	12100	-	25000	26300
.0033	-	-	11000	11000	-	22600	23800
.0039	-	-	10100	10100	-	20800	21900
.0047	-	-	9200	9200	-	18900	19900
.0056	4900	-	8400	8400	16400	17400	18300
.0068	4500	-	7600	7600	14900	15700	16600
.0082	4100	-	6900	6500	13600	14300	15100
.01	3700	4400	6300	5900	12300	13000	13700
.012	3400	4100	5700	5400	11200	11900	11600
.015	3000	3600	5100	4800	10000	10600	10300
.018	2800	3300	4400	4400	9200	9000	9400
.022	2500	3000	4000	4000	8300	8100	8500
.027	2200	2700	3600	3300	7500	7300	7700
.033	2000	2400	3200	3000	6800	6600	7000
.039	1900	2100	2800	2800	6200	6100	-
.047	1700	1900	2500	2500	5300	5600	-
.056	1500	1800	2300	2300	4800	-	-
.068	1300	1600	2100	2100	4400	-	-
.082	1200	1400	1900	1900	4000	-	-
.1	1100	1200	1700	1700	3600	-	-
.12	900	1100	1600	1500	-	-	-
.15	800	1000	1400	1300	-	-	-
.18	800	910	1200	1200	-	-	-
.22	700	820	1100	1100	-	-	-
.27	600	690	970	-	-	-	-
.33	500	620	880	-	-	-	-
.39	-	570	810	-	-	-	-
.47	-	520	740	-	-	-	-

Note: dV/dt ratings based on measurements made at junction of the wire leads and capacitor body.

Type 715P, Orange Drop[®], Polypropylene Film/Foil Capacitors

RMS Voltage vs. Frequency @ +85°C

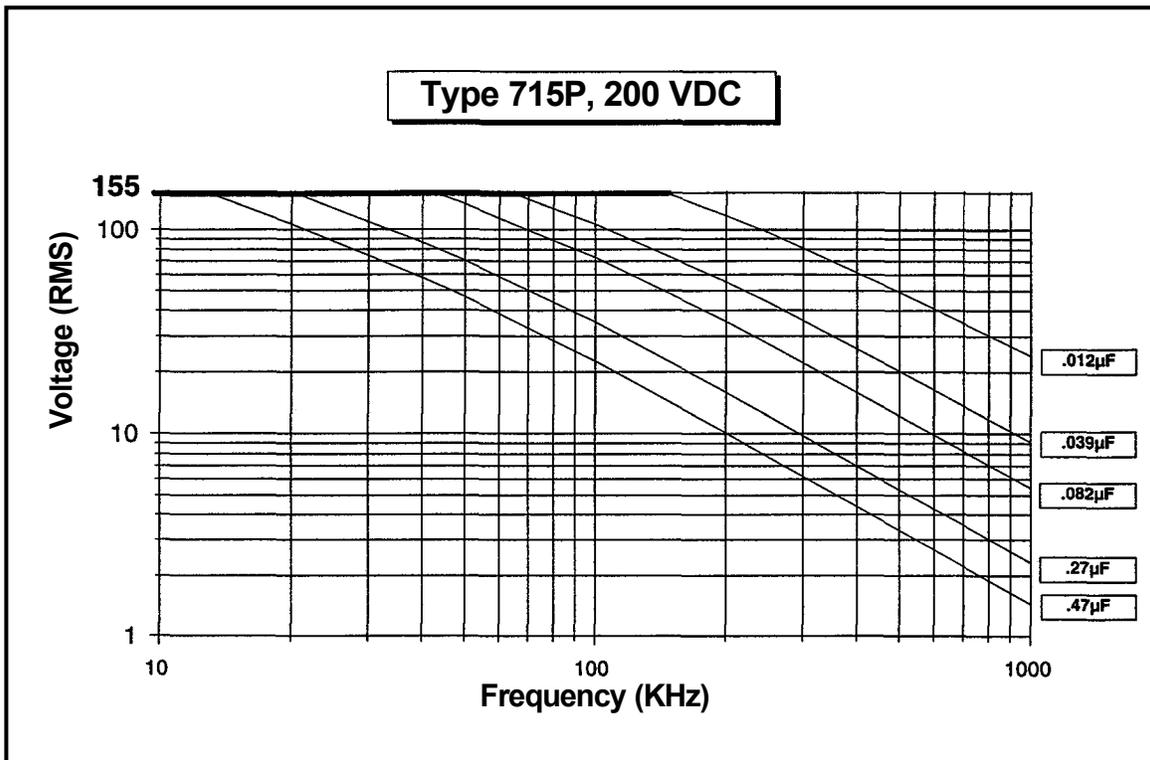
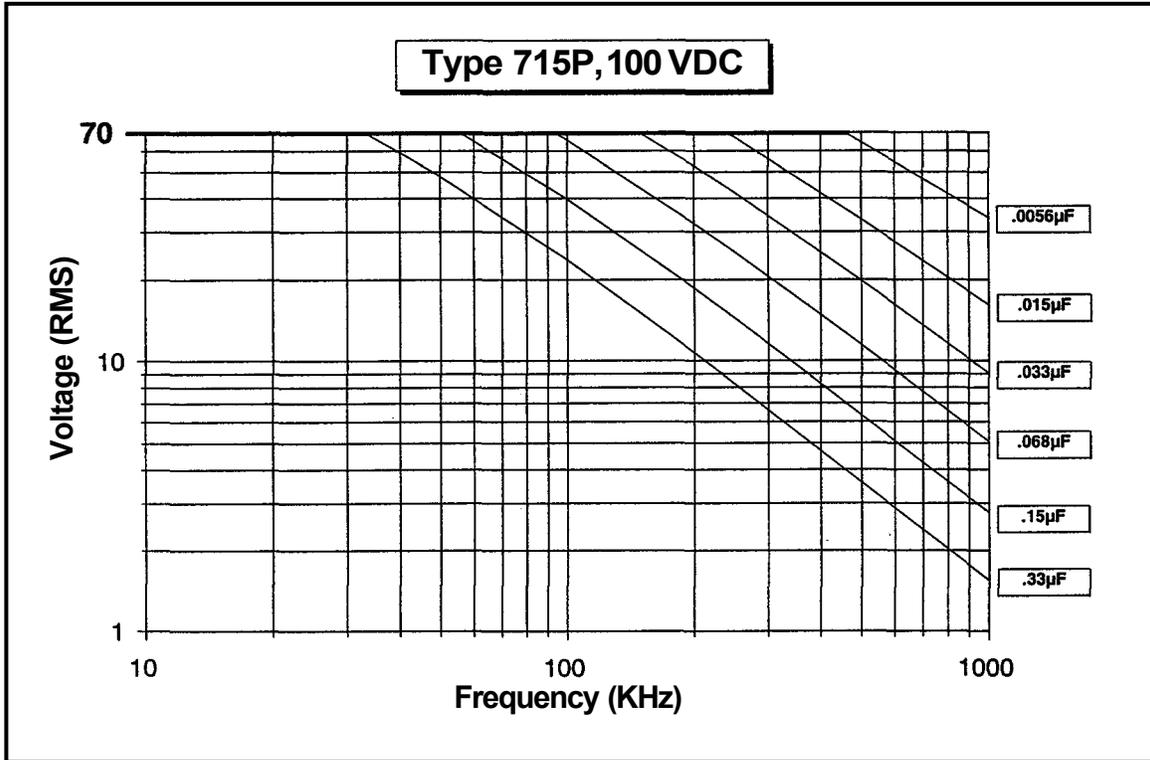

Type 715P, Orange Drop[®], Polypropylene Film/Foil Capacitors

RMS Voltage vs. Frequency @ +85°C

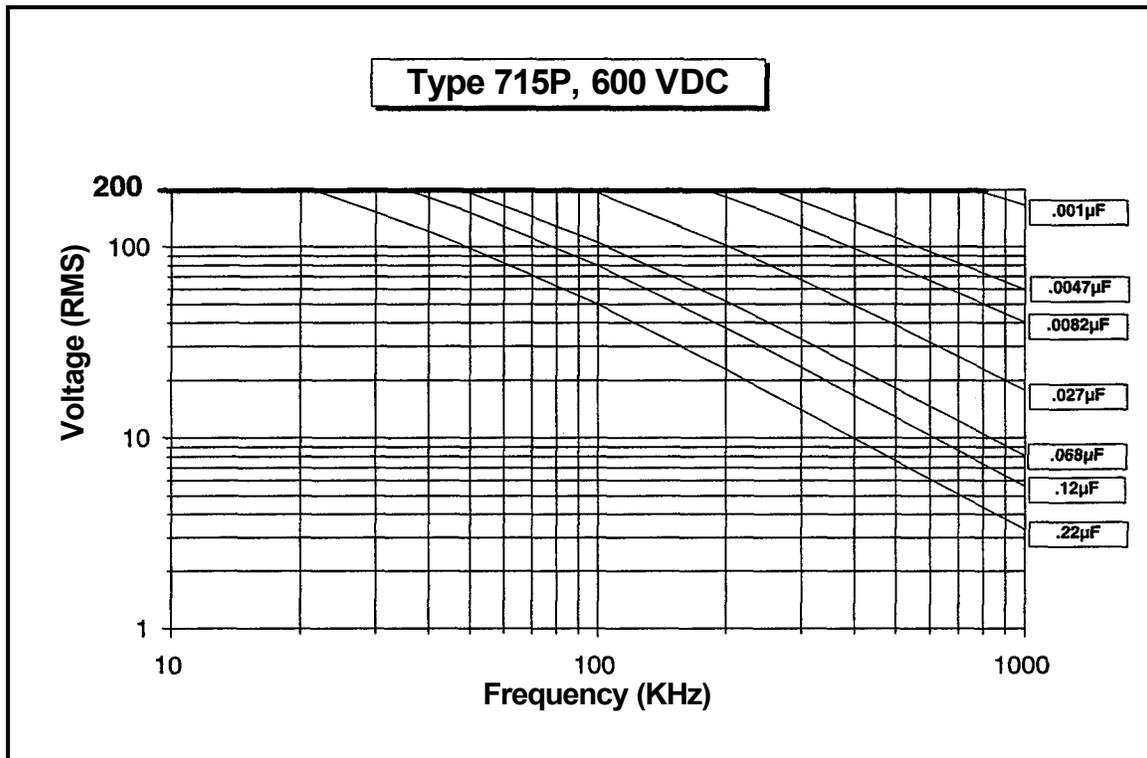
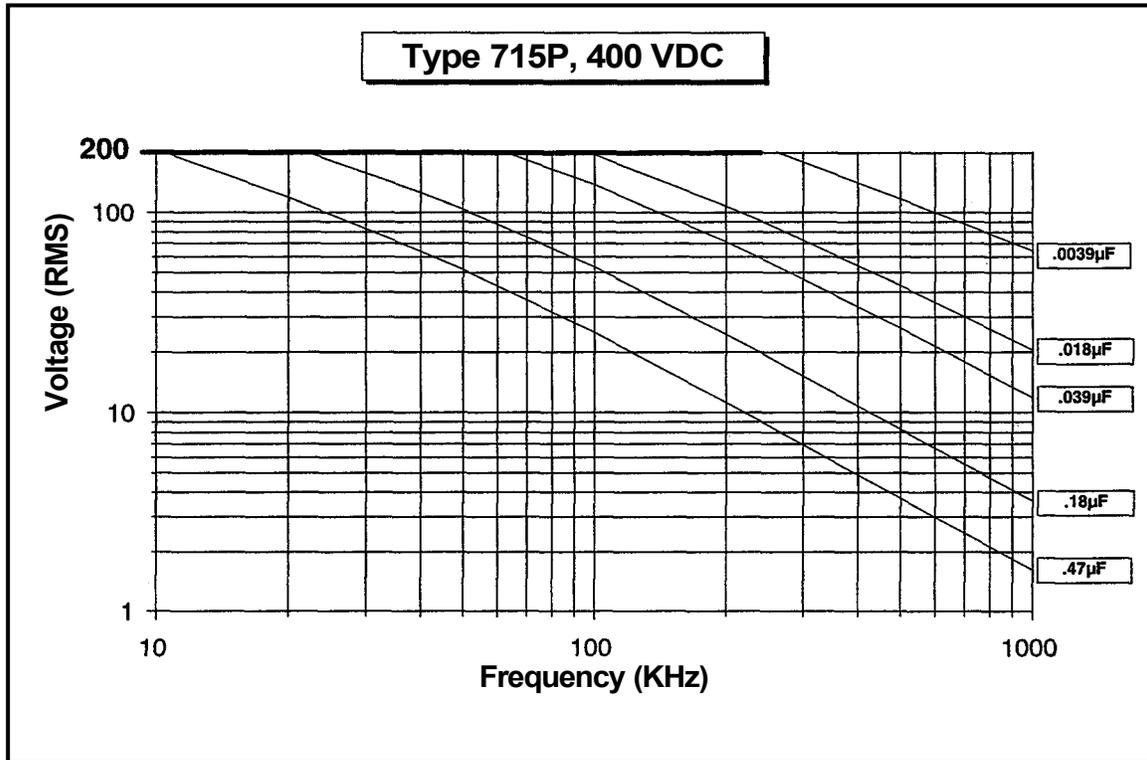

Type 715P, Orange Drop[®], Polypropylene Film/Foil Capacitors

RMS Voltage vs. Frequency @ +85°C

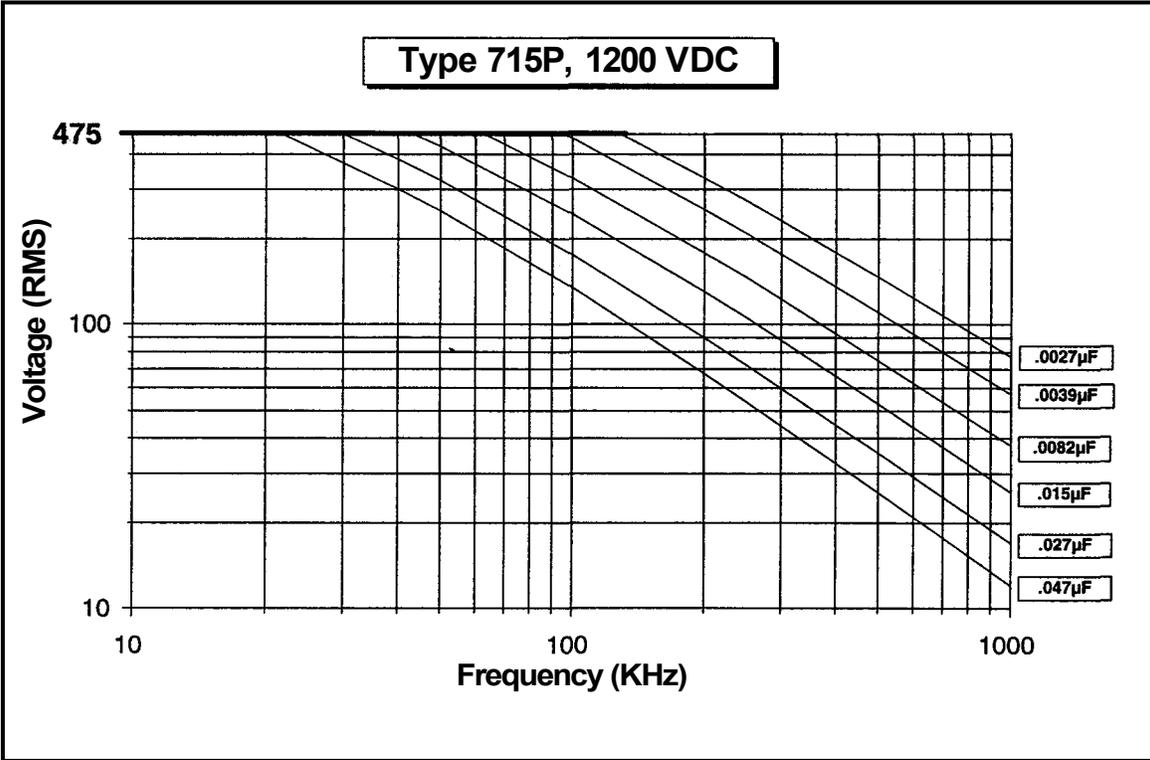
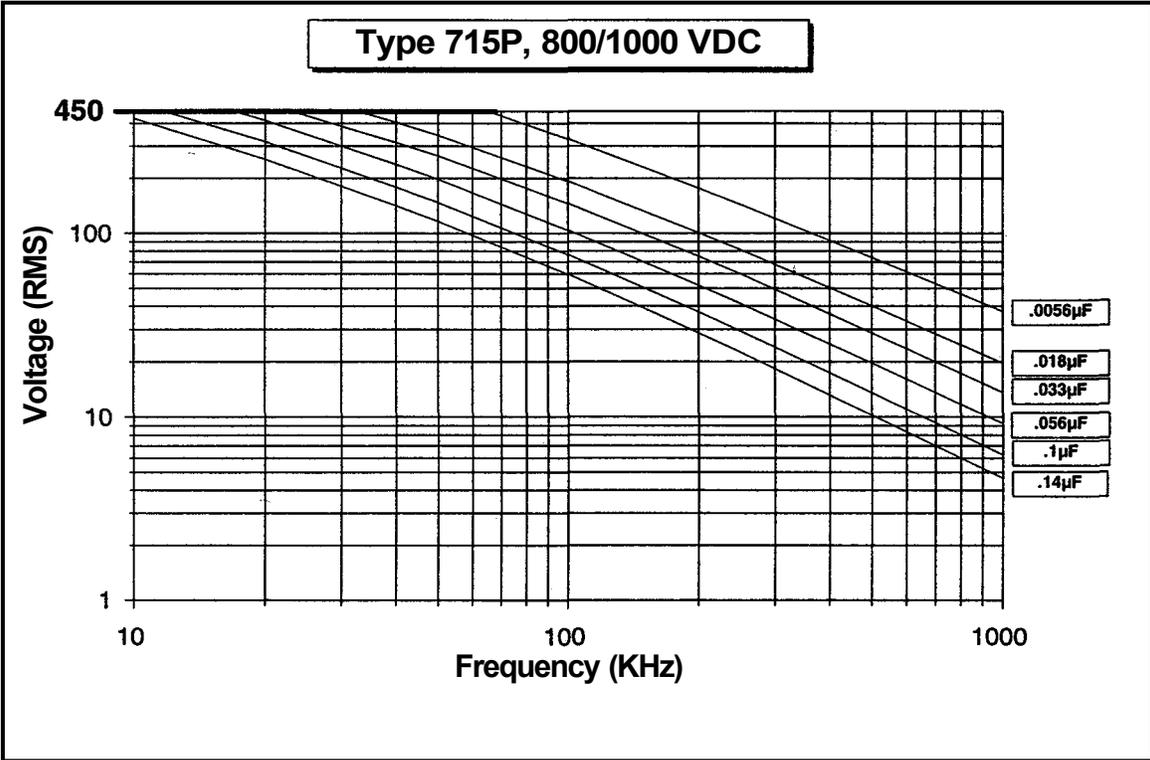

Type 715P, Orange Drop[®], Polypropylene Film/Foil Capacitors

RMS Voltage vs. Frequency @ +85°C

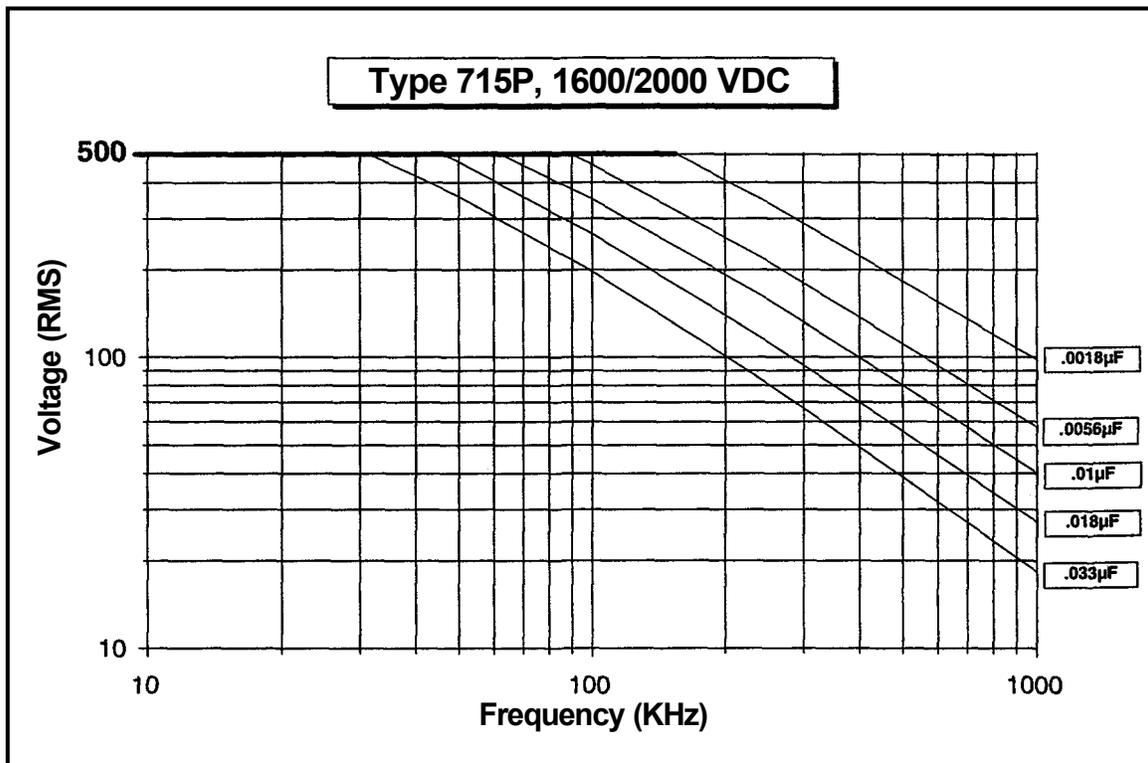

Type 715P, Orange Drop[®], Polypropylene Film/Foil Capacitors

Typical Impedance vs. Frequency

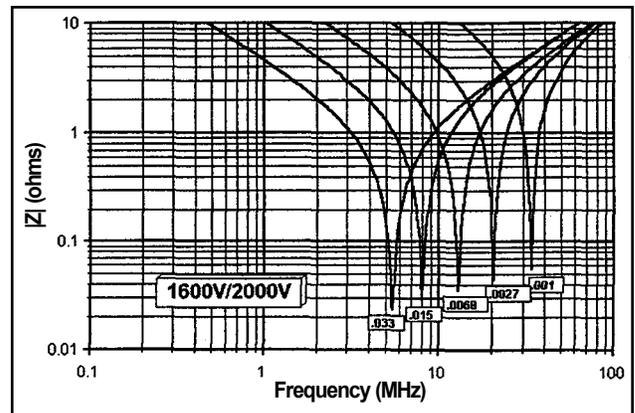
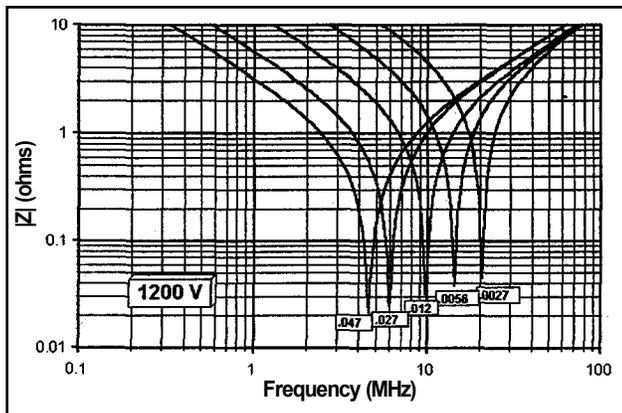
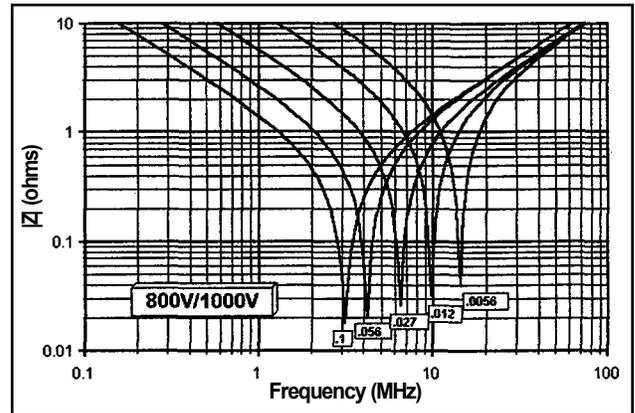
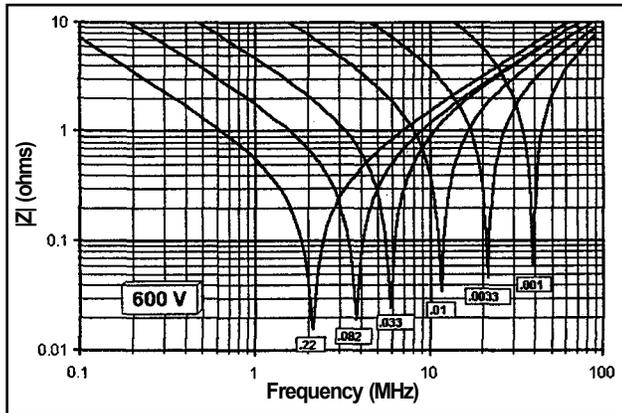
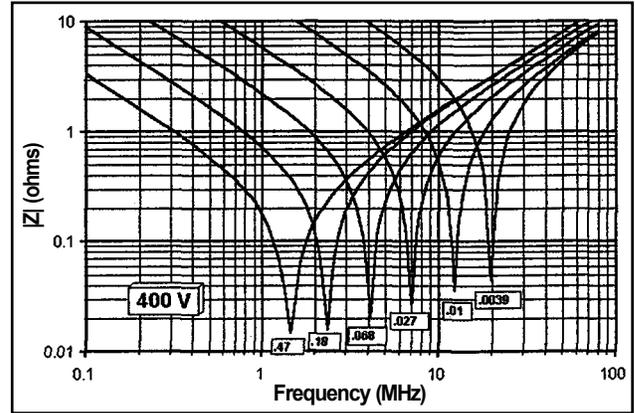
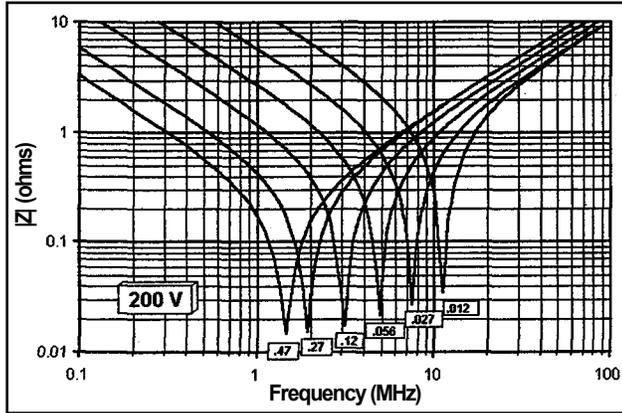

Please note: Capacitance values above are in μF . The resonant frequency and impedance shown above apply to units with a 0.250" lead length and are typical values only. Please contact us for data on the 100VDC rated units.



Компания «ЭлектроПласт» предлагает заключение долгосрочных отношений при поставках импортных электронных компонентов на взаимовыгодных условиях!

Наши преимущества:

- Оперативные поставки широкого спектра электронных компонентов отечественного и импортного производства напрямую от производителей и с крупнейших мировых складов;
- Поставка более 17-ти миллионов наименований электронных компонентов;
- Поставка сложных, дефицитных, либо снятых с производства позиций;
- Оперативные сроки поставки под заказ (от 5 рабочих дней);
- Экспресс доставка в любую точку России;
- Техническая поддержка проекта, помощь в подборе аналогов, поставка прототипов;
- Система менеджмента качества сертифицирована по Международному стандарту ISO 9001;
- Лицензия ФСБ на осуществление работ с использованием сведений, составляющих государственную тайну;
- Поставка специализированных компонентов (Xilinx, Altera, Analog Devices, Intersil, Interpoint, Microsemi, Aeroflex, Peregrine, Syfer, Eurofarad, Texas Instrument, Miteq, Cobham, E2V, MA-COM, Hittite, Mini-Circuits, General Dynamics и др.);

Помимо этого, одним из направлений компании «ЭлектроПласт» является направление «Источники питания». Мы предлагаем Вам помощь Конструкторского отдела:

- Подбор оптимального решения, техническое обоснование при выборе компонента;
- Подбор аналогов;
- Консультации по применению компонента;
- Поставка образцов и прототипов;
- Техническая поддержка проекта;
- Защита от снятия компонента с производства.



Как с нами связаться

Телефон: 8 (812) 309 58 32 (многоканальный)

Факс: 8 (812) 320-02-42

Электронная почта: org@eplast1.ru

Адрес: 198099, г. Санкт-Петербург, ул. Калинина, дом 2, корпус 4, литера А.