

Part* Number	DESC Drawing Number	Relay Description
CD00CFW		Basic Solid-State Relay (SSR)
CD00CFY	90091-008	
CD01CFW		SSR with Control Status
CD01CFY	90091-006	
CD20CDW		SSR with Short-Circuit Protection
CD20CDY	90091-004	
CD21CDW		SSR with Short-Circuit Protection and Control Status
CD21CDY	90091-002	

\* The Y suffix denotes parameters tested to MIL-PRF-28750 specifications.  
The W suffix denotes parameters tested to Teledyne specifications.  
For surface mount (SMT), add "S" prefix to part number. Example:  
SCD00CFW

### ELECTRICAL SPECIFICATIONS

(-55°C TO +105°C UNLESS OTHERWISE NOTED)

#### INPUT (CONTROL) SPECIFICATION

When used in 2 terminal configuration

(TTL or direct control) (See Fig. 1)	Min	Typ	Max	Units
Input Current @ $V_{IN} = 5$ Vdc (See Fig. 2)		14	15	mA
Turn-Off Voltage (Guaranteed Off)			1.5	Vdc
Turn-On Voltage (Guaranteed On)	3.8			Vdc
Reverse Voltage Protection			-32	Vdc
Input Supply Range (See Note 4)	3.8		6	Vdc

#### INPUT (CONTROL) SPECIFICATION

When used in 3 terminal configuration

(CMOS or open collector TTL) (See Fig. 1)	Min	Typ	Max	Units
Control Current				
$V_{CONTROL} = 5$ Vdc			250	$\mu$ A
$V_{CONTROL} = 18$ Vdc			1	mA
Control Voltage Range	0		18	Vdc
Bias Supply Voltage (See Note 4)	3.8		6	Vdc
Bias Supply Current @ $V_{BIAS} = 5$ Vdc		14	15	mA
Turn-Off Voltage (Guaranteed Off)	3.2			Vdc
Turn-On Voltage (Guaranteed On)			0.3	Vdc

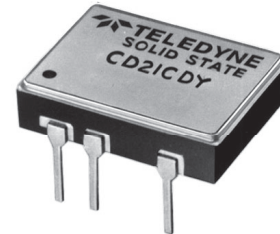

### FEATURES

- Available with short circuit/current overload protection
- Available with input status monitor
- TTL and CMOS compatible control
- Low ON resistance power FET output
- Fast switching speed
- Meets 28 Vdc system requirements of MIL-STD-704
- Optical isolation
- Low profile hermetic ceramic package
- Built and tested to the requirements of MIL-PRF-28750

### DESCRIPTION

This all solid-state relay utilizes the latest technology to provide a low ON resistance. The control (input) and load (output) are optically isolated to protect input logic circuits from voltage and current transients which can occur on the output supply. The optical isolation also provides a full floating output, thus allowing the load to be connected to either output terminal. The control circuit is buffered to enable the relay to be driven directly from standard CMOS or open collector TTL logic circuits. Available options include short circuit and current overload protection, which provides complete protection for both the relay and the system wiring. This feature not only provides protection should a short or overload occur while the relay is on, but will also provide protection should the relay be switched into a short. In either case, the relay will sense the short circuit condition and then block it indefinitely until the short is removed and the unit is reset by cycling the input control. The second option is a status output, which provides a built-in-test function. This feature checks the input circuitry of the relay and provides a logic (0) low when the input circuit is turned on and operational. Both options are available either together or separately as standard features.

**OUTPUT (LOAD) SPECIFICATIONS**

(See Note 2) **Min Typ Max Units**

Continuous Load Current (See Fig. 3)				
CD20CD			1.0	Adc
CD21CD			1.0	Adc
CD00CF			2.0	Adc
CD01CF			2.0	Adc

Leakage Current @  $V_{LOAD} = 60$  Vdc **40  $\mu$ Adc**

Output Voltage Drop				
CD20CD			0.6	Vdc
CD21CD			0.6	Vdc
CD00CF			0.75	Vdc
CD01CF			0.75	Vdc

Continuous Operating Load Voltage **60 Vdc**

Transient Blocking Voltage (See Note 3) **80 Vdc**

ON Resistance $R_{ds}$ (on) at $T_J = 25^\circ\text{C}$ $I_{LOAD} = 100$ mAdc (See Fig. 4)				
CD20CD		0.36	0.45	Ohm
CD21CD		0.36	0.45	Ohm
CD00CF		0.16	0.22	Ohm
CD01CF		0.16	0.22	Ohm

Turn-On Time (See Fig. 5) **1.5 ms**

Turn-Off Time (See Fig. 5) **0.25 ms**

Electrical System Spike  **$\pm 600$  Vdc**

Output Capacitance at 25 Vdc, 100 KHz **475 pF**

Input to Output Capacitance **10 pF**

Dielectric Strength **1000 Vac**

Insulation Resistance @ 500 Vdc  **$10^9$  Ohm**

Maximum Junction Temperature ( $T_J$  Max)

CD00	150	$^\circ\text{C}$
CD01	150	$^\circ\text{C}$

Thermal Resistance Junction to Ambient ( $\theta_{JA}$ ) **80  $^\circ\text{C/W}$**

Thermal Resistance Junction to Case ( $\theta_{JC}$ ) **20  $^\circ\text{C/W}$**

**STATUS OUTPUT SPECIFICATIONS**

(CD01CF AND CD21CD) **Min Typ Max Units**

Status Supply Voltage (See Note 7)			30	Vdc
Status Leakage Current @ 15 Vdc			4	$\mu$ Adc
Status (sink) Current ( $V_{SO} < 0.3$ Vdc)			2	mAcd

**BLOCK DIAGRAM (BOTTOM VIEW)**

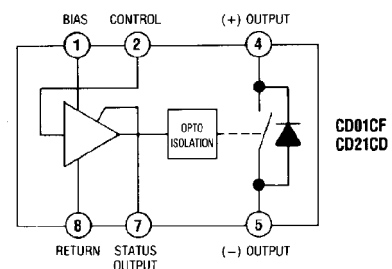
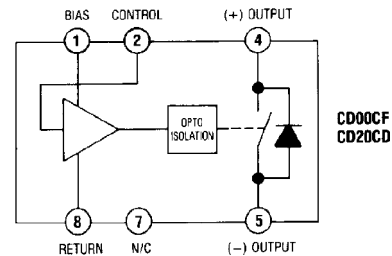

**MECHANICAL SPECIFICATIONS**

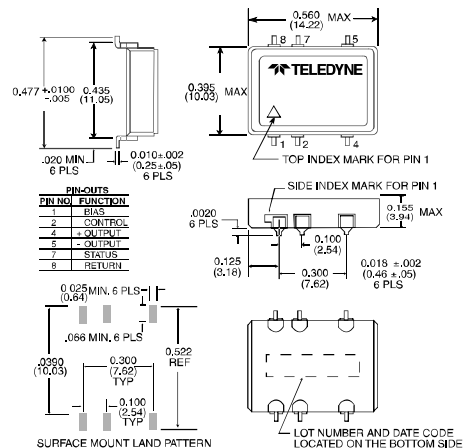

**SCD SERIES OUTLINE**

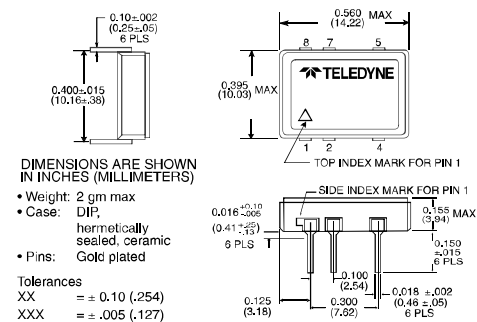

**CD SERIES OUTLINE**

**SHORT CIRCUIT SPECIFICATIONS**

(CD20CD AND CD21CD)	Min	Typ	Max	Units
Surge Current (See Fig. 7 and Note 6)		2.4		Adc

**ENVIRONMENTAL SPECIFICATIONS**

	Min	Typ	Max	Units
Temperature Range				
Operating	-55		+105	°C
Storage	-55		+125	°C
Vibration, 100 g	10		3000	Hz
Constant Acceleration			5000	g
Shock, 0.5 ms			1500	g

**TABLE 1: STATUS OUTPUT TRUTH TABLE**  
(CD01CF AND CD21CD)

Control Voltage	Output Status	Status Output Level
High	Off	High ( $V_{SO} = V_{STATUS}$ )
Low	On	Low ( $V_{SO} \leq 0.3 V_{dc}$ )

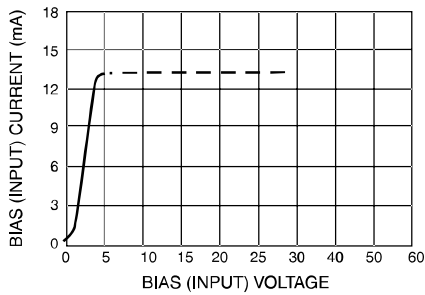

**INPUT CURRENT VS VOLTAGE**  
FIGURE 2 (SEE NOTE 4)

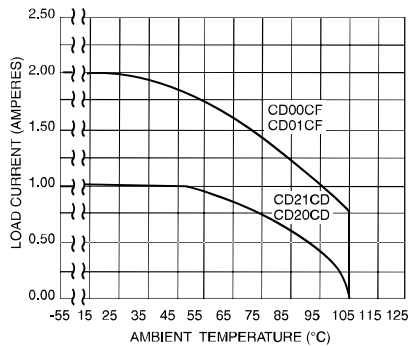

**LOAD CURRENT DERATING CURVE**  
FIGURE 3

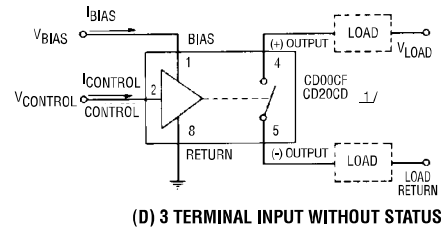
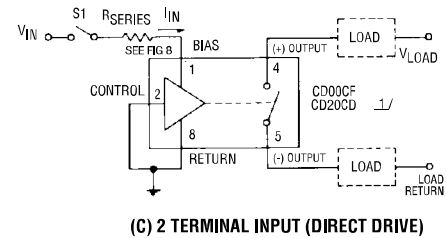
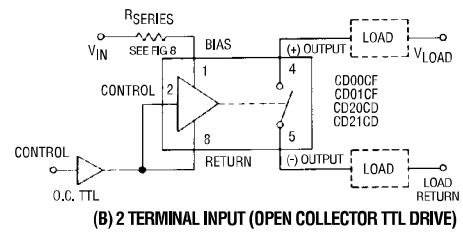
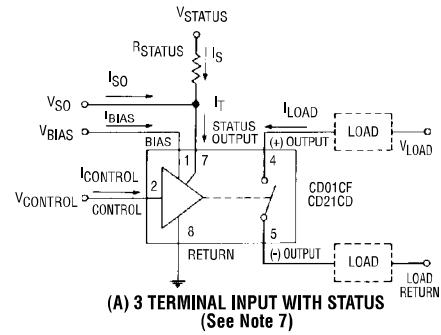

1/ CD21CD AND CD01CF MAY BE WIRED WITHOUT THE STATUS LINE AS SHOWN IN (C) AND (D)

**WIRING CONFIGURATIONS**  
FIGURE 1 (SEE NOTE 8)

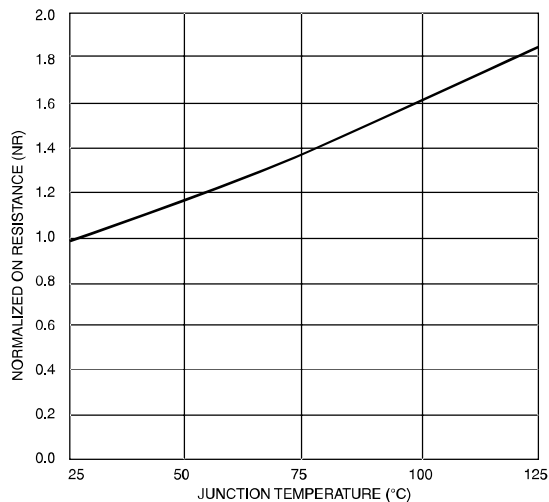

**NORMALIZED ON RESISTANCE VS JUNCTION TEMPERATURE**  
FIGURE 4 (SEE NOTE 5)

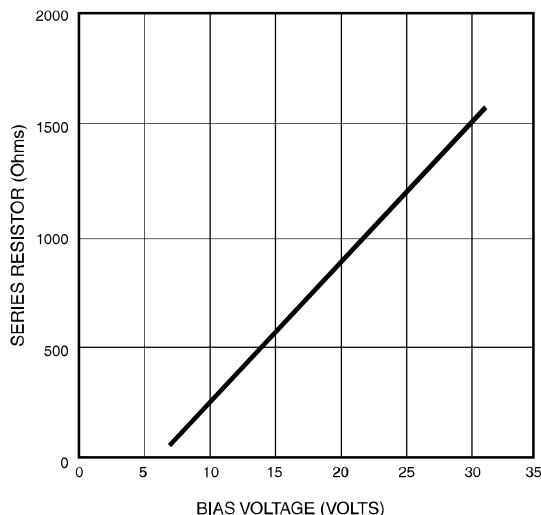

**SERIES LIMIT BIAS RESISTOR VS BIAS VOLTAGE**  
FIGURE 8 (SEE NOTE 4)

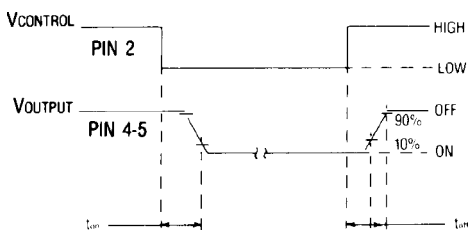

**OUTPUT TURN-ON AND TURN-OFF TIMING**  
FIGURE 5

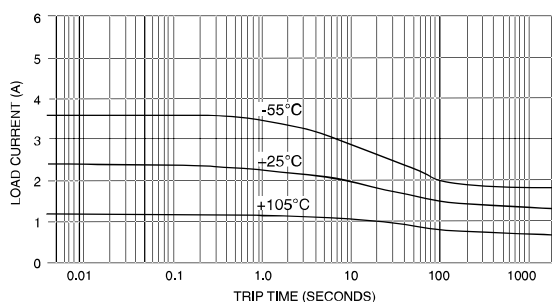

**TRIP CURRENT VS TIME**  
FIGURE 7 (SEE NOTE 6)

**NOTES:**

- Control input is compatible with CMOS or open collector TTL (with pull up resistor).
- The rated input voltage is 5V for all tests unless otherwise specified.
- Transient blocking voltage tests are performed per MIL-STD-704 (28 Vdc systems).
- For bias voltages above 6V, a series resistor is required. Use the standard resistor value equal to or less than the value found from Figure 8.
- To calculate the maximum ON resistance for a given junction temperature, find the normalized ON resistance factor (NR) from Figure 4. Calculate the new ON resistance as follows:  
 (CD00CD, CD01CD)  $R_{(ON)} = NR \cdot R_{ON} @ 25^{\circ}C$   
 (CD20CD, CD21CD)  $R_{(ON)} = 0.2 \cdot NR + 0.21$
- Overload testing to the requirements of MIL-PRF-28750 is constrained to the limits imposed by the short circuit protection characteristics as defined in this specification. System series inductance for "shorted-load" mode of operation should be 30  $\mu$ H maximum. Maximum repetition rate into a shorted load should not exceed 10 Hz.
- A status pull up resistor is required for proper operation of the status output. Determine the current (I<sub>so</sub>) required by the status interface. Calculate the current (I<sub>s</sub>) through the status resistor such that the sink current through the status output is 2 mA. Select the status resistor such that it does not allow more than 2 mA to flow through the status output.  

$$R_{STATUS} = \frac{V_{STATUS} - 0.3V}{2\text{ mA} - I_{so}}$$
- Inductive loads should be diode suppressed. Input transitions should be  $\leq$  1 ms duration and the input drive should be a bounceless contact type.



Компания «ЭлектроПласт» предлагает заключение долгосрочных отношений при поставках импортных электронных компонентов на взаимовыгодных условиях!

Наши преимущества:

- Оперативные поставки широкого спектра электронных компонентов отечественного и импортного производства напрямую от производителей и с крупнейших мировых складов;
- Поставка более 17-ти миллионов наименований электронных компонентов;
- Поставка сложных, дефицитных, либо снятых с производства позиций;
- Оперативные сроки поставки под заказ (от 5 рабочих дней);
- Экспресс доставка в любую точку России;
- Техническая поддержка проекта, помощь в подборе аналогов, поставка прототипов;
- Система менеджмента качества сертифицирована по Международному стандарту ISO 9001;
- Лицензия ФСБ на осуществление работ с использованием сведений, составляющих государственную тайну;
- Поставка специализированных компонентов (Xilinx, Altera, Analog Devices, Intersil, Interpoint, Microsemi, Aeroflex, Peregrine, Syfer, Eurofarad, Texas Instrument, Miteq, Cobham, E2V, MA-COM, Hittite, Mini-Circuits, General Dynamics и др.);

Помимо этого, одним из направлений компании «ЭлектроПласт» является направление «Источники питания». Мы предлагаем Вам помощь Конструкторского отдела:

- Подбор оптимального решения, техническое обоснование при выборе компонента;
- Подбор аналогов;
- Консультации по применению компонента;
- Поставка образцов и прототипов;
- Техническая поддержка проекта;
- Защита от снятия компонента с производства.



#### Как с нами связаться

**Телефон:** 8 (812) 309 58 32 (многоканальный)

**Факс:** 8 (812) 320-02-42

**Электронная почта:** [org@eplast1.ru](mailto:org@eplast1.ru)

**Адрес:** 198099, г. Санкт-Петербург, ул. Калинина, дом 2, корпус 4, литера А.