

**NPN Silicon AF Transistors**

- For AF driver and output stages
- High collector current
- Low collector-emitter saturation voltage
- Complementary types: BCX51...BCX53 (PNP)
- Pb-free (RoHS compliant) package
- Qualified according AEC Q101



Type	Marking	Pin Configuration			Package
		1=B	2=C	3=E	
BCX54-16	BD	1=B	2=C	3=E	SOT89
BCX55	BE	1=B	2=C	3=E	SOT89
BCX55-16	BM	1=B	2=C	3=E	SOT89
BCX56	BH	1=B	2=C	3=E	SOT89
BCX56-10	BK	1=B	2=C	3=E	SOT89
BCX56-16	BL	1=B	2=C	3=E	SOT89

**Maximum Ratings**

Parameter	Symbol	Value	Unit
Collector-emitter voltage	$V_{CEO}$		-
BCX54		45	
BCX55		60	
BCX56		80	
Collector-base voltage	$V_{CBO}$		V
BCX54		45	
BCX55		60	
BCX56		100	
Emitter-base voltage	$V_{EBO}$	5	
Collector current	$I_C$	1	A
Peak collector current, $t_p \leq 10$ ms	$I_{CM}$	1.5	
Base current	$I_B$	100	mA
Peak base current	$I_{BM}$	200	
Total power dissipation- $T_S \leq 120^\circ\text{C}$	$P_{tot}$	2	W
Junction temperature	$T_j$	150	$^\circ\text{C}$
Storage temperature	$T_{stg}$	-65 ... 150	

**Thermal Resistance**

Parameter	Symbol	Value	Unit
Junction - soldering point <sup>1)</sup>	$R_{thJS}$	$\leq 15$	K/W

<sup>1</sup>For calculation of  $R_{thJA}$  please refer to Application Note AN077 (Thermal Resistance Calculation)

**Electrical Characteristics at  $T_A = 25^\circ\text{C}$ , unless otherwise specified**

Parameter	Symbol	Values			Unit
		min.	typ.	max.	
<b>DC Characteristics</b>					
Collector-emitter breakdown voltage $I_C = 10\text{ mA}$ , $I_B = 0$ , BCX54 $I_C = 10\text{ mA}$ , $I_B = 0$ , BCX55 $I_C = 10\text{ mA}$ , $I_B = 0$ , BCX56	$V_{(BR)CEO}$	45 60 80	- - -	- - -	V
Collector-base breakdown voltage $I_C = 100\ \mu\text{A}$ , $I_E = 0$ , BCX54 $I_C = 100\ \mu\text{A}$ , $I_E = 0$ , BCX55 $I_C = 100\ \mu\text{A}$ , $I_E = 0$ , BCX56	$V_{(BR)CBO}$	45 60 100	- - -	- - -	
Emitter-base breakdown voltage $I_E = 10\ \mu\text{A}$ , $I_C = 0$	$V_{(BR)EBO}$	5	-	-	
Collector-base cutoff current $V_{CB} = 30\text{ V}$ , $I_E = 0$ $V_{CB} = 30\text{ V}$ , $I_E = 0$ , $T_A = 150^\circ\text{C}$	$I_{CBO}$	- -	- -	0.1 20	$\mu\text{A}$
DC current gain <sup>1)</sup> $I_C = 5\text{ mA}$ , $V_{CE} = 2\text{ V}$ $I_C = 150\text{ mA}$ , $V_{CE} = 2\text{ V}$ , BCX55/BCX56 $I_C = 150\text{ mA}$ , $V_{CE} = 2\text{ V}$ , BCX55-10/BCX56-10 $I_C = 150\text{ mA}$ , $V_{CE} = 2\text{ V}$ , BCX54-16...BCX56-16 $I_C = 500\text{ mA}$ , $V_{CE} = 2\text{ V}$	$h_{FE}$	25 40 63 100 25	- - 100 160 -	- 250 160 250 -	-
Collector-emitter saturation voltage <sup>1)</sup> $I_C = 500\text{ mA}$ , $I_B = 50\text{ mA}$	$V_{CEsat}$	-	-	0.5	V
Base-emitter voltage- $I_C = 500\text{ mA}$ , $V_{CE} = 2\text{ V}$	$V_{BE(ON)}$	-	-	1	
<b>AC Characteristics</b>					
Transition frequency $I_C = 50\text{ mA}$ , $V_{CE} = 10\text{ V}$ , $f = 20\text{ MHz}$	$f_T$	-	100	-	MHz

<sup>1)</sup>Pulse test:  $t < 300\ \mu\text{s}$ ;  $D < 2\%$

**DC current gain  $h_{FE} = f(I_C)$**

$V_{CE} = 2\text{ V}$

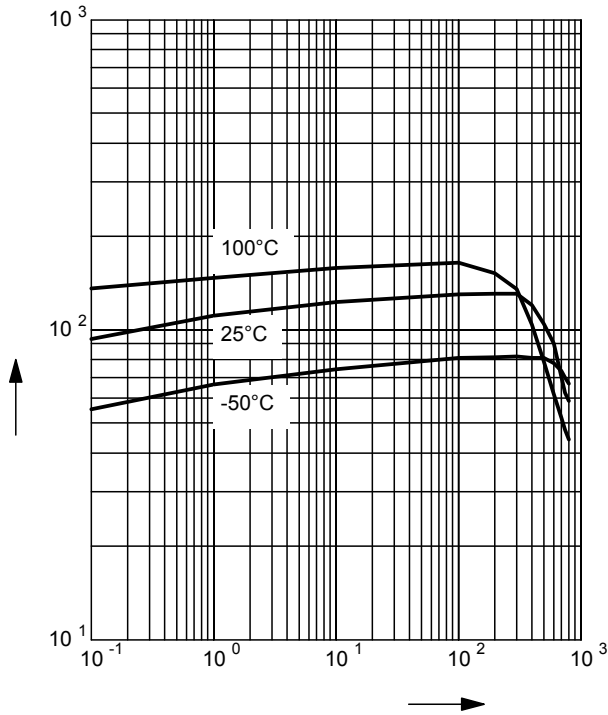

**Collector-emitter saturation voltage**

$I_C = f(V_{CEsat}), h_{FE} = 10$

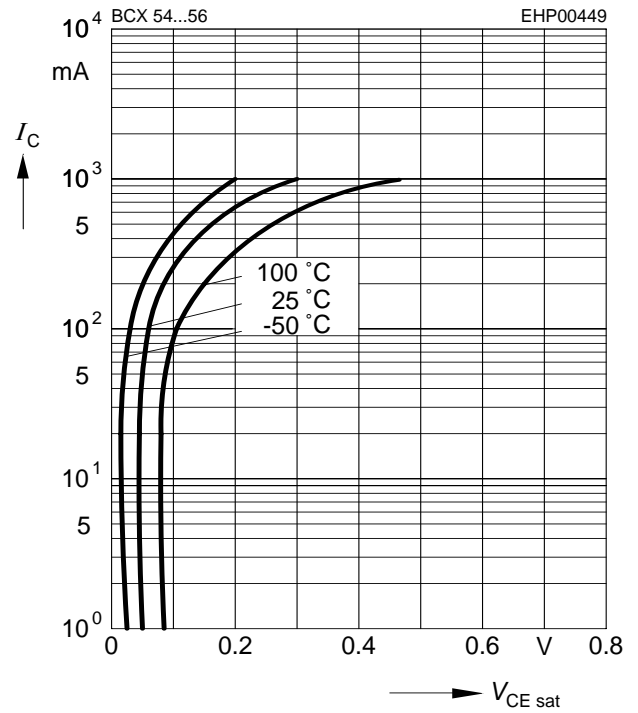

**Base-emitter saturation voltage**

$I_C = f(V_{BEsat}), h_{FE} = 10$

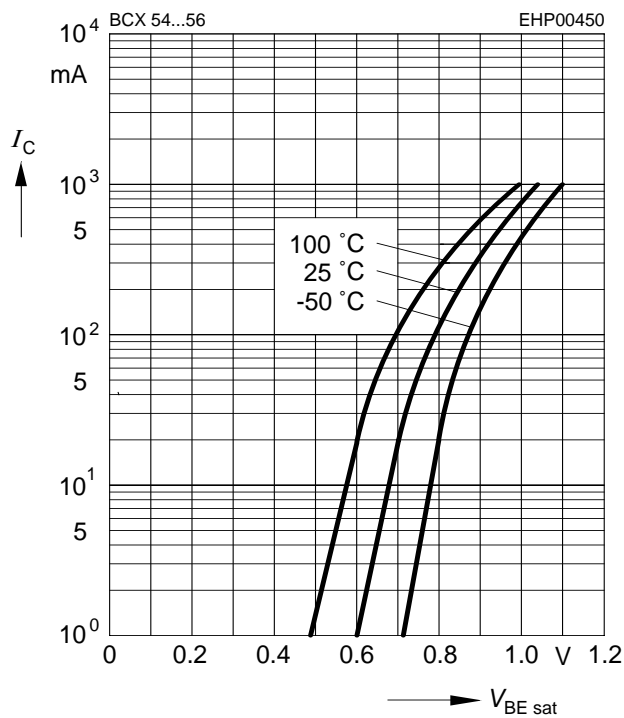

**Collector current  $I_C = f(V_{BE})$**

$V_{CE} = 2\text{ V}$

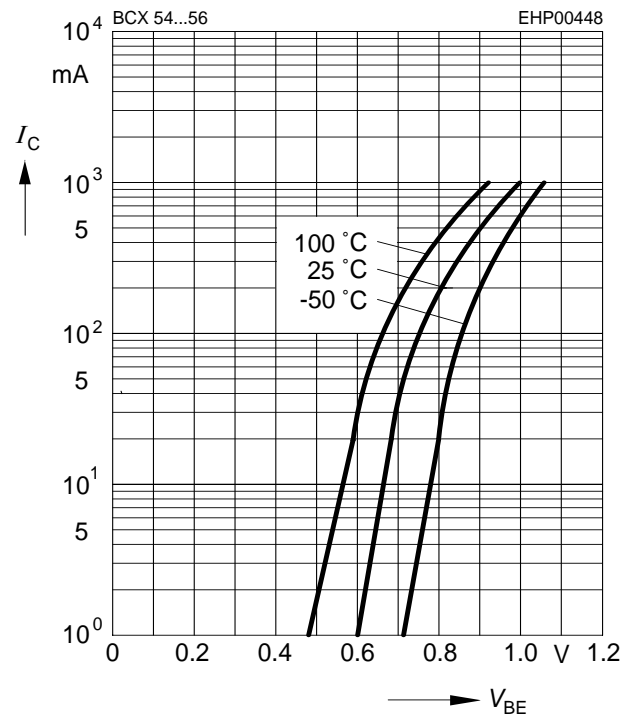

Collector cutoff current  $I_{CBO} = f(T_A)$

$V_{CBO} = 30\text{ V}$

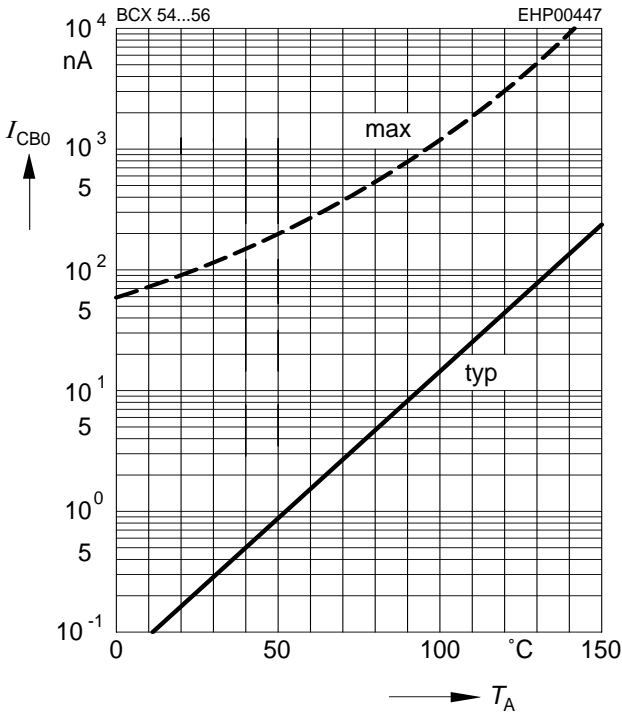

Transition frequency  $f_T = f(I_C)$

$V_{CE} = \text{parameter in V, } f = 2\text{ GHz}$

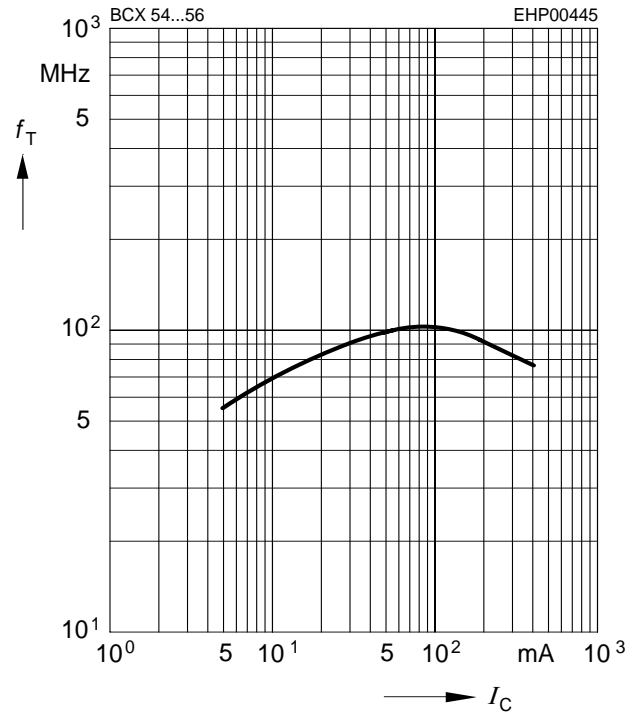

Total power dissipation  $P_{tot} = f(T_S)$

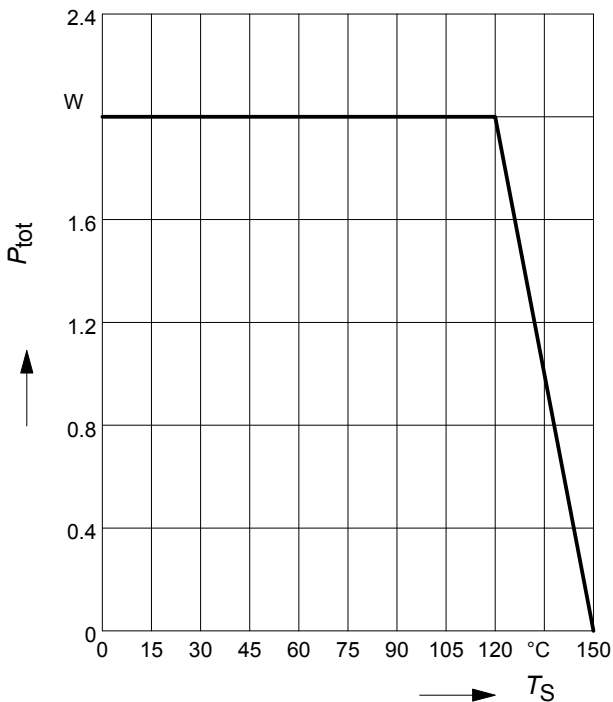

Permissible Pulse Load  $R_{thJS} = f(t_p)$

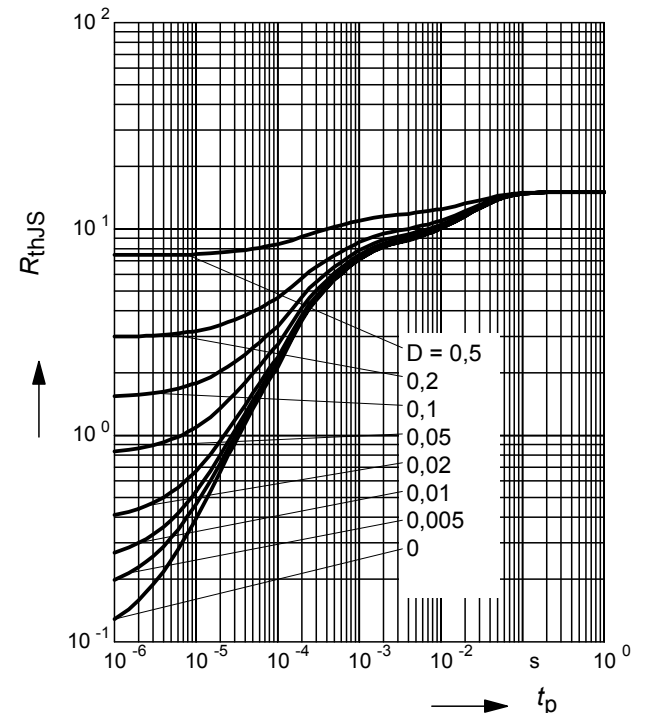

**Permissible Pulse Load**

$$P_{\text{totmax}}/P_{\text{totDC}} = f(t_p)$$

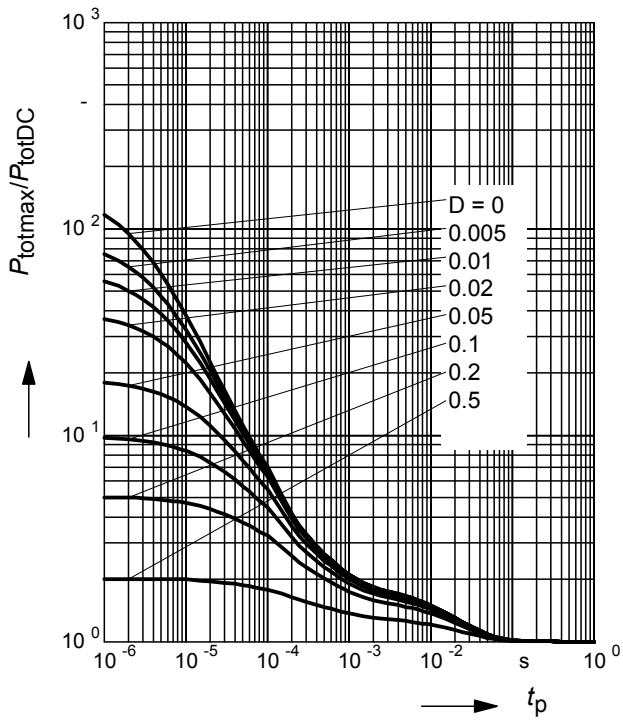

Package Outline

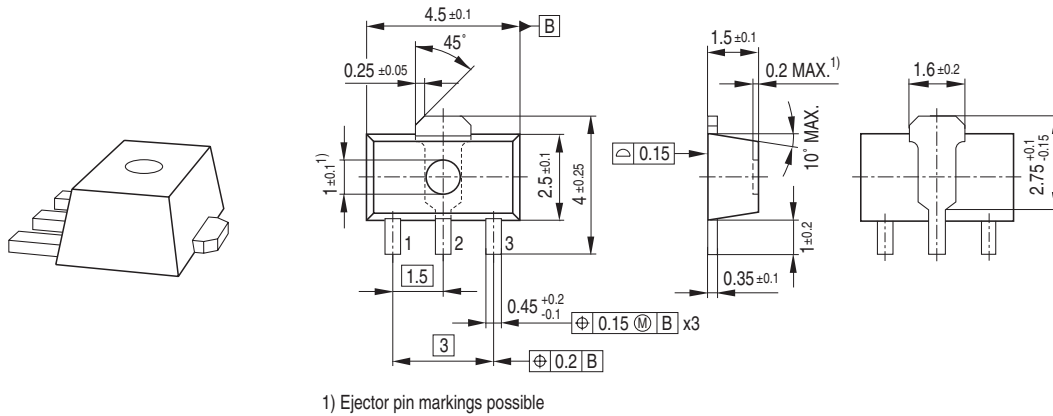

Foot Print

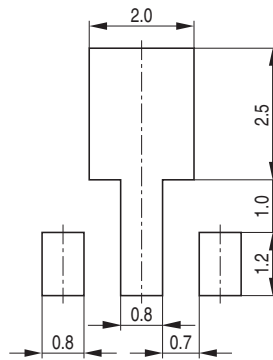

Marking Layout (Example)

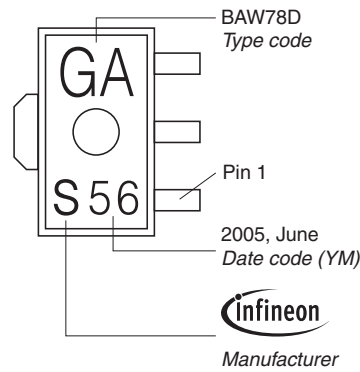

Standard Packing

Reel  $\phi$ 180 mm = 1.000 Pieces/Reel  
 Reel  $\phi$ 330 mm = 4.000 Pieces/Reel

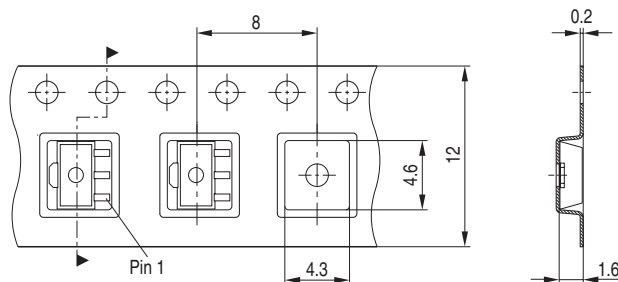

**Edition 2009-11-16**

**Published by  
Infineon Technologies AG  
81726 Munich, Germany**

**© 2009 Infineon Technologies AG  
All Rights Reserved.**

### **Legal Disclaimer**

The information given in this document shall in no event be regarded as a guarantee of conditions or characteristics. With respect to any examples or hints given herein, any typical values stated herein and/or any information regarding the application of the device, Infineon Technologies hereby disclaims any and all warranties and liabilities of any kind, including without limitation, warranties of non-infringement of intellectual property rights of any third party.

### **Information**

For further information on technology, delivery terms and conditions and prices, please contact the nearest Infineon Technologies Office ([www.infineon.com](http://www.infineon.com)).

### **Warnings**

Due to technical requirements, components may contain dangerous substances. For information on the types in question, please contact the nearest Infineon Technologies Office.

Infineon Technologies components may be used in life-support devices or systems only with the express written approval of Infineon Technologies, if a failure of such components can reasonably be expected to cause the failure of that life-support device or system or to affect the safety or effectiveness of that device or system. Life support devices or systems are intended to be implanted in the human body or to support and/or maintain and sustain and/or protect human life. If they fail, it is reasonable to assume that the health of the user or other persons may be endangered.





Компания «ЭлектроПласт» предлагает заключение долгосрочных отношений при поставках импортных электронных компонентов на взаимовыгодных условиях!

Наши преимущества:

- Оперативные поставки широкого спектра электронных компонентов отечественного и импортного производства напрямую от производителей и с крупнейших мировых складов;
- Поставка более 17-ти миллионов наименований электронных компонентов;
- Поставка сложных, дефицитных, либо снятых с производства позиций;
- Оперативные сроки поставки под заказ (от 5 рабочих дней);
- Экспресс доставка в любую точку России;
- Техническая поддержка проекта, помощь в подборе аналогов, поставка прототипов;
- Система менеджмента качества сертифицирована по Международному стандарту ISO 9001;
- Лицензия ФСБ на осуществление работ с использованием сведений, составляющих государственную тайну;
- Поставка специализированных компонентов (Xilinx, Altera, Analog Devices, Intersil, Interpoint, Microsemi, Aeroflex, Peregrine, Syfer, Eurofarad, Texas Instrument, Miteq, Cobham, E2V, MA-COM, Hittite, Mini-Circuits, General Dynamics и др.);

Помимо этого, одним из направлений компании «ЭлектроПласт» является направление «Источники питания». Мы предлагаем Вам помощь Конструкторского отдела:

- Подбор оптимального решения, техническое обоснование при выборе компонента;
- Подбор аналогов;
- Консультации по применению компонента;
- Поставка образцов и прототипов;
- Техническая поддержка проекта;
- Защита от снятия компонента с производства.



#### Как с нами связаться

**Телефон:** 8 (812) 309 58 32 (многоканальный)

**Факс:** 8 (812) 320-02-42

**Электронная почта:** [org@eplast1.ru](mailto:org@eplast1.ru)

**Адрес:** 198099, г. Санкт-Петербург, ул. Калинина, дом 2, корпус 4, литера А.