

# HCPL-9000/-0900, -9030/-0930, HCPL-9031/-0931, -900J/-090J, HCPL-901J/-091J, -902J/-092J

## High Speed Digital Isolators



## Data Sheet



### Description

The HCPL-90xx and HCPL-09xx CMOS digital isolators feature high speed performance and excellent transient immunity specifications. The symmetric magnetic coupling barrier gives these devices a typical pulse width distortion of 2 ns, a typical propagation delay skew of 4 ns and 100 Mbaud data rate, making them the industry's fastest digital isolators.

The single channel digital isolators (HCPL-9000/-0900) features an active-low logic output enable. The dual channel digital isolators are configured as unidirectional (HCPL-9030/-0930) and bi-directional (HCPL-9031/-0931), operating in full duplex mode making it ideal for digital fieldbus applications.

The quad channel digital isolators are configured as unidirectional (HCPL-900J/-090J), two channels in one direction and two channels in opposite direction (HCPL-901J/-091J), and one channel in one direction and three channels in opposite direction (HCPL-902J/-092J). These high channel density make them ideally suited to isolating data conversion devices, parallel buses and peripheral interfaces.

They are available in 8-pin PDIP, 8-pin Gull Wing, 8-pin SOIC packages, and 16-pin SOIC narrow-body and wide-body packages. They are specified over the temperature range of -40°C to +100°C.

### Features

- +3.3V and +5V TTL/CMOS compatible
- 3 ns max. pulse width distortion
- 6 ns max. propagation delay skew
- 15 ns max. propagation delay
- High speed: 100 MBd
- 15 kV/ $\mu$ s min. common mode rejection
- Tri-state output (HCPL-9000/-0900)
- 2500V RMS isolation
- UL1577 and IEC 61010-1 approved

### Applications

- Digital fieldbus isolation
- Multiplexed data transmission
- Computer peripheral interface
- High speed digital systems
- Isolated data interfaces
- Logic level shifting

**CAUTION:** It is advised that normal static precautions be taken in handling and assembly of this component to prevent damage and/or degradation which may be induced by ESD.

## Selection Guide

Device Number	Channel Configuration	Package
HCPL-9000	Single	8-pin DIP (300 Mil)
HCPL-0900	Single	8-pin Small Outline
HCPL-9030	Dual	8-pin DIP (300 Mil)
HCPL-0930	Dual	8-pin Small Outline
HCPL-9031	Dual, Bi-Directional	8-pin DIP (300 Mil)
HCPL-0931	Dual, Bi-Directional	8-pin Small Outline
HCPL-900J	Quad	16-pin Small Outline, Wide Body
HCPL-090J	Quad	16-pin Small Outline, Narrow Body
HCPL-901J	Quad, 2/2, Bi-Directional	16-pin Small Outline, Wide Body
HCPL-091J	Quad, 2/2, Bi-Directional	16-pin Small Outline, Narrow Body
HCPL-902J	Quad, 1/3, Bi-Directional	16-pin Small Outline, Wide Body
HCPL-092J	Quad, 1/3, Bi-Directional	16-pin Small Outline, Narrow Body

## Ordering Information

HCPL-09xx and HCPL-90xx are UL Recognized with 2500 V<sub>rms</sub> for 1 minute per UL1577.

Part number	Option		Package	Surface Mount	Gull Wing	Tape & Reel	Quantity
	RoHS Compliant	Non RoHS Compliant					
HCPL-9000	-000E	No option	300mil DIP-8				50 per tube
HCPL-9030	-300E	-300		X	X		50 per tube
HCPL-9031	-500E	-500		X	X	X	1000 per reel
HCPL-0900	-000E	No option	SO-8	X			100 per tube
HCPL-0930	-500E	-500		X		X	1500 per reel
HCPL-0931							
HCPL-900J	-000E	No option	Wide Body SO-16	X			50 per tube
HCPL-901J	-500E	-500		X		X	1000 per reel
HCPL-902J							
HCPL-090J	-000E	No option	Narrow Body SO-16	X			50 per tube
HCPL-091J	-500E	-500		X		X	1000 per reel
HCPL-092J							

To order, choose a part number from the part number column and combine with the desired option from the option column to form an order entry.

Example 1:

HCPL-9031-500E to order product of 300mil DIP Gull Wing Surface Mount package in Tape and Reel in RoHS compliant.

Example 2:

HCPL-0900 to order product of SO-8 package in tube packaging and non RoHS compliant.

Option datasheets are available. Contact your Avago sales representative or authorized distributor for information.

## Pin Description

Symbol	Description
$V_{DD1}$	Power Supply 1
$V_{DD2}$	Power Supply 2
$IN_x$	Logic Input Signal
$OUT_x$	Logic Output Signal
$GND_1$	Power Supply Ground 1
$GND_2$	Power Supply Ground 2
$\overline{V}_{OE}$	Logic Output Enable (Single Channel), Active Low
NC	Not Connected

## Functional Diagrams

### Single Channel



### Truth Table

$IN_1$	$\overline{V}_{OE}$	$OUT_1$
L	L	L
H	L	H
L	H	Z
H	H	Z

### Dual Channel



### Quad Channel



## Package Outline Drawings

### HCPL-9000, HCPL-9030 and HCPL-9031 Standard DIP Packages

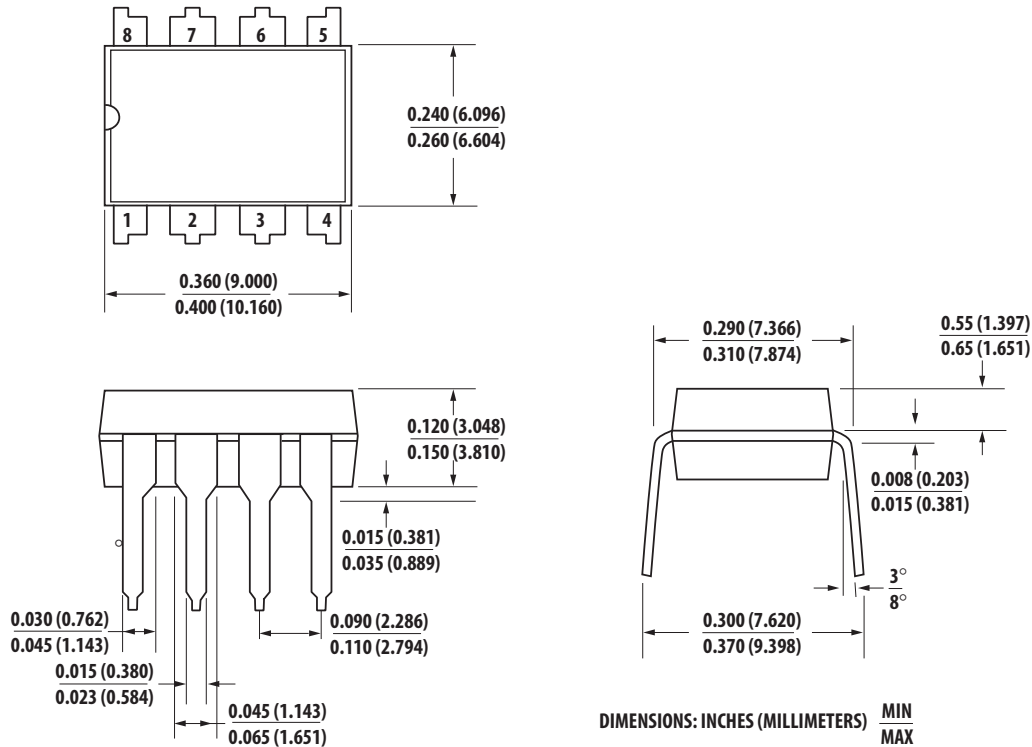

### HCPL-9000, HCPL-9030 and HCPL-9031 Gull Wing Surface Mount Option 300

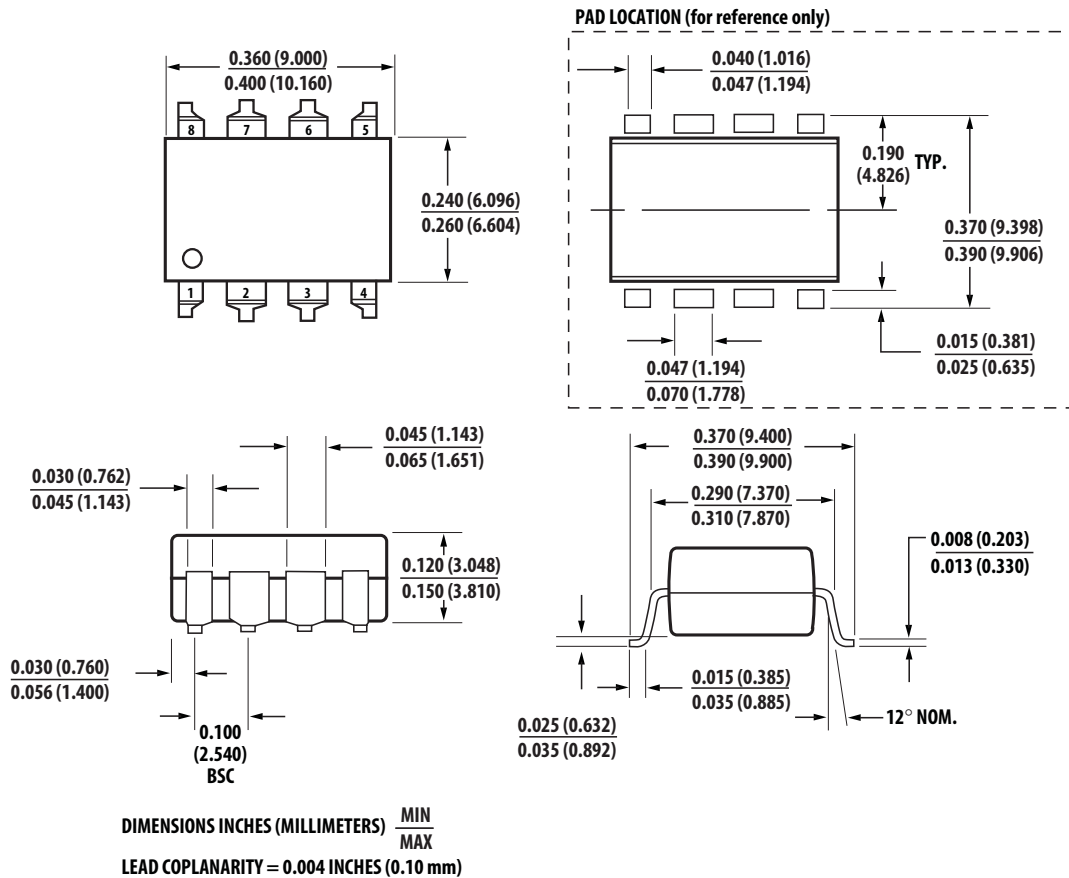

### HCPL-0900, HCPL-0930 and HCPL-0931 Small Outline SO-8 Package

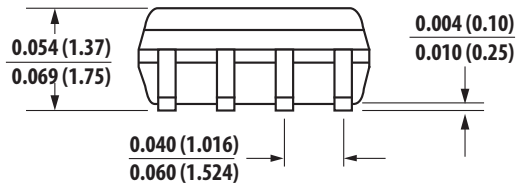

DIMENSIONS: INCHES (MILLIMETERS) MIN  
MAX

### HCPL-900J, HCPL-901J and HCPL-902J Wide Body SOIC-16 Package

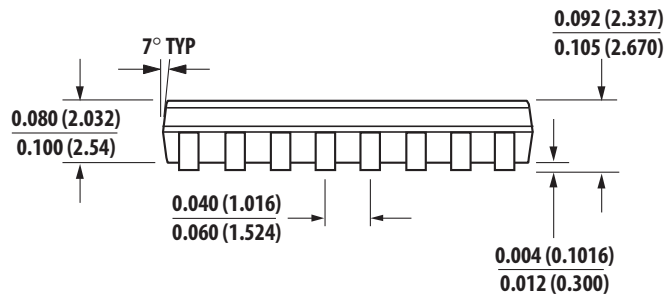

DIMENSIONS: INCHES (MILLIMETERS) MIN  
MAX

## HCPL-090J, HCPL-091J and HCPL-092J Narrow Body SOIC-16 Package

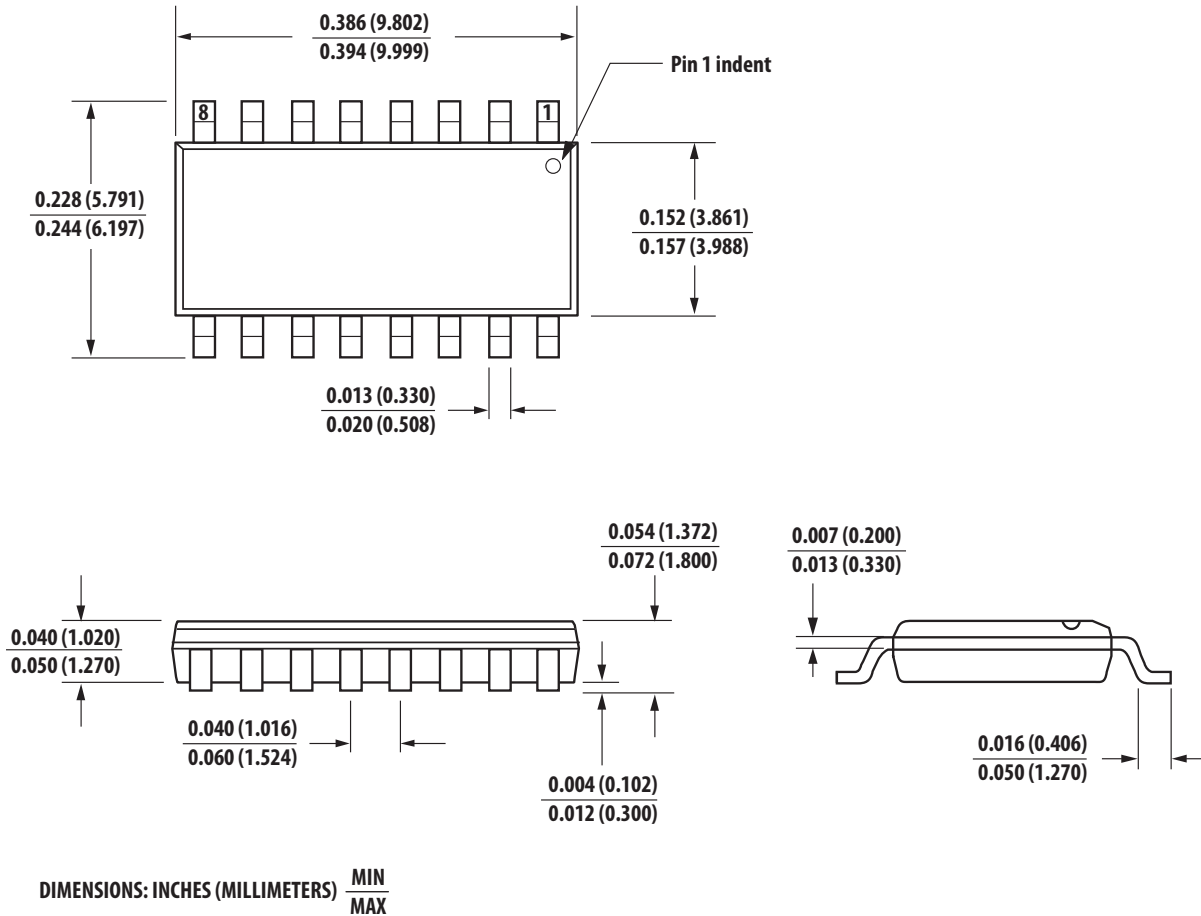

### Package Characteristics

Parameter	Symbol	Min.	Typ.	Max.	Units	Test Conditions
Capacitance (Input-Output) <sup>(1)</sup>	$C_{I-O}$				pF	f = 1 MHz
Single Channel			1.1			
Dual Channel			2.0			
Quad Channel			4.0			
Thermal Resistance	$\theta_{JCT}$				°C/W	Thermocouple located at center underside of package
8-Pin PDIP			54			
8-Pin SOIC			144			
16-Pin SOIC Narrow Body			41			
16-Pin SOIC Wide Body			28			
Package Power Dissipation	$P_{PD}$				mW	
8-Pin PDIP				150		
8-Pin SOIC				150		
16-Pin SOIC Narrow Body				150		
16-Pin SOIC Wide Body				150		

#### Notes:

1. Single and dual channels device are considered two-terminal devices: pins 1-4 shorted and pins 5-8 shorted. Quad channel devices are considered two-terminal devices: pins 1-8 shorted and pins 9-16 shorted.

This product has been tested for electrostatic sensitivity to the limits stated in the specifications. However, Avago recommends that all integrated circuits be handled with appropriate care to avoid damage. Damage caused by inappropriate handling or storage could range from performance degradation to complete failure.

## Insulation and Safety Related Specifications

Parameters	Condition	Min.	Typ.	Max.	Units
Barrier Impedance					$\Omega \parallel \mu\text{F}$
Single Channel			$>10^{14} \parallel 3$		
Dual Channel			$>10^{14} \parallel 3$		
Quad Channel			$>10^{14} \parallel 7$		
Creepage Distance (External)					mm
8-Pin PDIP		7.04			
8-Pin SOIC		4.04			
16-Pin SOIC Narrow Body		4.03			
16-Pin SOIC Wide Body		8.08			
Leakage Current	240 V <sub>RMS</sub> 60 Hz		0.2		$\mu\text{A}$

## IEC61010-1 Insulation Characteristics\*

Description	Symbol	HCPL-0900	HCPL-9000	Units
		HCPL-0930	HCPL-9030	
		HCPL-090J	HCPL-900J	
		HCPL-091J	HCPL-901J	
		HCPL-092J	HCPL-902J	
Installation classification per DIN VDE 0110/1.89, Table 1				
for rated mains voltage $\leq 150 \text{ V}_{\text{rms}}$		I – III	I – IV	
for rated mains voltage $\leq 300 \text{ V}_{\text{rms}}$			I – III	
Pollution Degree (DIN VDE 0110/1.89)		2	2	
Maximum Working Insulation Voltage	VIORM	150	300	V <sub>rms</sub>

## Absolute Maximum Ratings

Parameters	Symbol	Min.	Max.	Units
Storage Temperature	$T_S$	-55	150	°C
Ambient Operating Temperature <sup>(1)</sup>	$T_A$	-55	125	°C
Supply Voltage	$V_{DD1}, V_{DD2}$	-0.5	7	V
Input Voltage	$V_{IN}$	-0.5	$V_{DD1} + 0.5$	V
Voltage Output Enable (HCPL-9000/-0900)	$V_{OE}$	-0.5	$V_{DD2} + 0.5$	V
Output Voltage	$V_{OUT}$	-0.5	$V_{DD2} + 0.5$	V
Output Current Drive	$I_{OUT}$		10	mA
Lead Solder Temperature (10s)			260	°C
ESD	2 kV Human Body Model			

### Notes:

1. Absolute Maximum ambient operating temperature means the device will not be damaged if operated under these conditions. It does not guarantee performance.

## Recommended Operating Conditions

Parameters	Symbol	Min.	Max.	Units
Ambient Operating Temperature	$T_A$	-40	100	°C
Supply Voltage	$V_{DD1}, V_{DD2}$	3.0	5.5	V
Logic High Input Voltage	$V_{IH}$	2.4	$V_{DD1}$	V
Logic Low Input Voltage	$V_{IL}$	0	0.8	V
Input Signal Rise and Fall Times	$t_{IR}, t_{IF}$		1	µs

This product has been tested for electrostatic sensitivity to the limits stated in the specifications. However, Avago recommends that all integrated circuits be handled with appropriate care to avoid damage. Damage caused by inappropriate handling or storage could range from performance degradation to complete failure.



### 3.3V operation: Electrical Specifications

Test conditions that are not specified can be anywhere within the recommended operating range.

All typical specifications are at  $T_A = +25^\circ\text{C}$ ,  $V_{DD1} = V_{DD2} = +3.3\text{V}$ .

Parameter	Symbol	Min.	Typ.	Max.	Units	Test Conditions
Quiescent Supply Current 1	$I_{DD1}$				mA	$V_{IN} = 0\text{V}$
HCPL-9000/-0900			0.008	0.01		
HCPL-9030/-0930			0.008	0.01		
HCPL-9031/-0931			1.5	2.0		
HCPL-900J/-090J			0.018	0.02		
HCPL-901J/-091J			3.3	4.0		
HCPL-902J/-092J			1.5	2.0		
Quiescent Supply Current 2	$I_{DD2}$				mA	$V_{IN} = 0\text{V}$
HCPL-9000/-0900			3.3	4.0		
HCPL-9030/-0930			3.3	4.0		
HCPL-9031/-0931			1.5	2.0		
HCPL-900J/-090J			5.5	8.0		
HCPL-901J/-091J			3.3	4.0		
HCPL-902J/-092J			3.0	6.0		
Logic Input Current	$I_{IN}$	-10		10	$\mu\text{A}$	
Logic High Output Voltage	$V_{OH}$	$V_{DD2} - 0.1$	$V_{DD2}$		V	$I_{OUT} = -20\ \mu\text{A}$ , $V_{IN} = V_{IH}$
		$0.8 * V_{DD2}$	$V_{DD2} - 0.5$		V	$I_{OUT} = -4\ \text{mA}$ , $V_{IN} = V_{IH}$
Logic Low Output Voltage	$V_{OL}$		0	0.1	V	$I_{OUT} = 20\ \mu\text{A}$ , $V_{IN} = V_{IL}$
			0.5	0.8	V	$I_{OUT} = 4\ \text{mA}$ , $V_{IN} = V_{IL}$

### Switching Specifications

Maximum Data Rate		100	110		MBd	$C_L = 15\ \text{pF}$
Clock Frequency	$f_{max}$			50	MHz	
Propagation Delay Time to Logic Low Output	$t_{PHL}$		12	18	ns	
Propagation Delay Time to Logic High Output	$t_{PLH}$		12	18	ns	
Pulse Width	$t_{PW}$	10			ns	
Pulse Width Distortion <sup>[1]</sup>	$ \text{PWD} $		2	3	ns	
	$ t_{PHL} - t_{PLH} $					
Propagation Delay Skew <sup>[2]</sup>	$t_{PSK}$		4	6	ns	
Output Rise Time (10 – 90%)	$t_R$		2	4	ns	
Output Fall Time (10 – 90%)	$t_F$		2	4	ns	
Propagation Delay Enable to Output (Single Channel)						
High to High Impedance	$t_{PHZ}$		3	5	ns	
Low to High Impedance	$t_{PLZ}$		3	5	ns	
High Impedance to High	$t_{PZH}$		3	5	ns	
High Impedance to Low	$t_{PZL}$		3	5	ns	
Channel-to-Channel Skew (Dual and Quad Channels)	$t_{CSK}$		2	3	ns	
Common Mode Transient Immunity (Output Logic High or Logic Low) <sup>[3]</sup>	$ CM_H $ $ CM_L $	15	18		kV/ $\mu\text{s}$	$V_{cm} = 1000\text{V}$

#### Notes:

1. PWD is defined as  $|t_{PHL} - t_{PLH}|$ . %PWD is equal to the PWD divided by the pulse width.
2.  $t_{PSK}$  is equal to the magnitude of the worst case difference in  $t_{PHL}$  and/or  $t_{PLH}$  that will be seen between units at  $25^\circ\text{C}$ .
3.  $CM_H$  is the maximum common mode voltage slew rate that can be sustained while maintaining  $V_{OUT} > 0.8V_{DD2}$ .  $CM_L$  is the maximum common mode input voltage that can be sustained while maintaining  $V_{OUT} < 0.8V$ . The common mode voltage slew rates apply to both rising and falling common mode voltage edges.

This product has been tested for electrostatic sensitivity to the limits stated in the specifications. However, Avago recommends that all integrated circuits be handled with appropriate care to avoid damage. Damage caused by inappropriate handling or storage could range from performance degradation to complete failure.

## 5V operation: Electrical Specifications

Test conditions that are not specified can be anywhere within the recommended operating range.

All typical specifications are at  $T_A = +25^\circ\text{C}$ ,  $V_{DD1} = V_{DD2} = +5.0\text{V}$ .

Parameter	Symbol	Min.	Typ.	Max.	Units	Test Conditions
Quiescent Supply Current 1	$I_{DD1}$				mA	$V_{IN} = 0\text{V}$
HCPL-9000/-0900			0.012	0.018		
HCPL-9030/-0930			0.012	0.018		
HCPL-9031/-0931			2.5	3.0		
HCPL-900J/-090J			0.024	0.036		
HCPL-901J/-091J			5.0	6.0		
HCPL-902J/-092J			2.5	3.0		
Quiescent Supply Current 2	$I_{DD2}$				mA	$V_{IN} = 0\text{V}$
HCPL-9000/-0900			5.0	6.0		
HCPL-9030/-0930			5.0	6.0		
HCPL-9031/-0931			2.5	3.0		
HCPL-900J/-090J			8.0	12.0		
HCPL-901J/-091J			5.0	6.0		
HCPL-902J/-092J			6.0	9.0		
Logic Input Current	$I_{IN}$	-10		10	$\mu\text{A}$	
Logic High Output Voltage	$V_{OH}$	$V_{DD2} - 0.1$	$V_{DD2}$		V	$I_{OUT} = -20\ \mu\text{A}$ , $V_{IN} = V_{IH}$
		$0.8 * V_{DD2}$	$V_{DD2} - 0.5$		V	$I_{OUT} = -4\ \text{mA}$ , $V_{IN} = V_{IH}$
Logic Low Output Voltage	$V_{OL}$		0	0.1	V	$I_{OUT} = 20\ \mu\text{A}$ , $V_{IN} = V_{IL}$
			0.5	0.8	V	$I_{OUT} = 4\ \text{mA}$ , $V_{IN} = V_{IL}$

## Switching Specifications

Maximum Data Rate		100	110		MBd	$C_L = 15\ \text{pF}$
Clock Frequency	$f_{max}$			50	MHz	
Propagation Delay Time to Logic Low Output	$t_{PHL}$		10	15	ns	
Propagation Delay Time to Logic High Output	$t_{PLH}$		10	15	ns	
Pulse Width	$t_{PW}$	10			ns	
Pulse Width Distortion <sup>[1]</sup>	$ PWD $		2	3	ns	
	$ t_{PHL} - t_{PLH} $					
Propagation Delay Skew <sup>[2]</sup>	$t_{PSK}$		4	6	ns	
Output Rise Time (10 – 90%)	$t_R$		1	3	ns	
Output Fall Time (10 – 90%)	$t_F$		1	3	ns	
Propagation Delay Enable to Output (Single Channel)						
High to High Impedance	$t_{PHZ}$		3	5	ns	
Low to High Impedance	$t_{PLZ}$		3	5	ns	
High Impedance to High	$t_{PZH}$		3	5	ns	
High Impedance to Low	$t_{PZL}$		3	5	ns	
Channel-to-Channel Skew (Dual and Quad Channels)	$t_{CSK}$		2	3	ns	
Common Mode Transient Immunity (Output Logic High or Logic Low) <sup>[3]</sup>	$ CM_H $ $ CM_L $	15	18		$\text{kV}/\mu\text{s}$	$V_{cm} = 1000\text{V}$

### Notes:

- PWD is defined as  $|t_{PHL} - t_{PLH}|$ . %PWD is equal to the PWD divided by the pulse width.
- $t_{PSK}$  is equal to the magnitude of the worst case difference in  $t_{PHL}$  and/or  $t_{PLH}$  that will be seen between units at  $25^\circ\text{C}$ .
- $CM_H$  is the maximum common mode voltage slew rate that can be sustained while maintaining  $V_{OUT} > 0.8V_{DD2}$ .  $CM_L$  is the maximum common mode input voltage that can be sustained while maintaining  $V_{OUT} < 0.8V$ . The common mode voltage slew rates apply to both rising and falling common mode voltage edges.

This product has been tested for electrostatic sensitivity to the limits stated in the specifications. However, Avago recommends that all integrated circuits be handled with appropriate care to avoid damage. Damage caused by inappropriate handling or storage could range from performance degradation to complete failure.

## Mixed 5V/3.3V or 3.3V/5V operation: Electrical Specifications

Test conditions that are not specified can be anywhere within the recommended operating range.

All typical specifications are at  $T_A = +25^\circ\text{C}$ ,  $V_{DD1} = +5.0\text{V}$ ,  $V_{DD2} = +3.3\text{V}$ .

Parameter	Symbol	Min.	Typ.	Max.	Units	Test Conditions
HCPL-9000/-0900	$I_{DD1}$		0.012	0.018		
HCPL-9030/-0930			0.012	0.018		
HCPL-9031/-0931			2.5	3.0		
HCPL-900J/-090J			0.024	0.036		
HCPL-901J/-091J			5.0	6.0		
HCPL-902J/-092J			2.5	3.0		
Quiescent Supply Current 2	$I_{DD2}$				mA	$V_{IN} = 0\text{V}$
HCPL-9000/-0900			5.0	6.0		
HCPL-9030/-0930			5.0	6.0		
HCPL-9031/-0931			2.5	3.0		
HCPL-900J/-090J			8.0	12.0		
HCPL-901J/-091J			5.0	6.0		
HCPL-902J/-092J			6.0	9.0		
Logic Input Current	$I_{IN}$	-10		10	$\mu\text{A}$	
Logic High Output Voltage	$V_{OH}$	$V_{DD2} - 0.1$	$V_{DD2}$		V	$I_{OUT} = -20\ \mu\text{A}$ , $V_{IN} = V_{IH}$
		$0.8 * V_{DD2}$	$V_{DD2} - 0.5$		V	$I_{OUT} = -4\ \text{mA}$ , $V_{IN} = V_{IH}$
Logic Low Output Voltage	$V_{OL}$	0		0.1	V	$I_{OUT} = 20\ \mu\text{A}$ , $V_{IN} = V_{IL}$
			0.5	0.8	V	$I_{OUT} = 4\ \text{mA}$ , $V_{IN} = V_{IL}$

## Switching Specifications

Maximum Data Rate		100	110		MBd	$C_L = 15\ \text{pF}$
Clock Frequency	$f_{max}$			50	MHz	
Propagation Delay Time to Logic Low Output	$t_{PHL}$		12	18	ns	
Propagation Delay Time to Logic High Output	$t_{PLH}$		12	18	ns	
Pulse Width	$t_{PW}$	10			ns	
Pulse Width Distortion <sup>[1]</sup>	$ PWD $		2	3	ns	
	$ t_{PHL} - t_{PLH} $					
Propagation Delay Skew <sup>[2]</sup>	$t_{PSK}$		4	6	ns	
Output Rise Time (10 – 90%)	$t_R$		2	4	ns	
Output Fall Time (10 – 90%)	$t_F$		2	4	ns	
Propagation Delay Enable to Output (Single Channel)						
High to High Impedance	$t_{PHZ}$		3	5	ns	
Low to High Impedance	$t_{PLZ}$		3	5	ns	
High Impedance to High	$t_{PZH}$		3	5	ns	
High Impedance to Low	$t_{PZL}$		3	5	ns	
Channel-to-Channel Skew (Dual and Quad Channels)	$t_{CSK}$		2	3	ns	
Common Mode Transient Immunity (Output Logic High or Logic Low) <sup>[3]</sup>	$ CM_H $ $ CM_L $	15	18		kV/ $\mu\text{s}$	$V_{cm} = 1000\text{V}$

### Notes:

- PWD is defined as  $|t_{PHL} - t_{PLH}|$ . %PWD is equal to the PWD divided by the pulse width.
- $t_{PSK}$  is equal to the magnitude of the worst case difference in  $t_{PHL}$  and/or  $t_{PLH}$  that will be seen between units at  $25^\circ\text{C}$ .
- $CM_H$  is the maximum common mode voltage slew rate that can be sustained while maintaining  $V_{OUT} > 0.8V_{DD2}$ .  $CM_L$  is the maximum common mode input voltage that can be sustained while maintaining  $V_{OUT} < 0.8\text{V}$ . The common mode voltage slew rates apply to both rising and falling common mode voltage edges.

This product has been tested for electrostatic sensitivity to the limits stated in the specifications. However, Avago recommends that all integrated circuits be handled with appropriate care to avoid damage. Damage caused by inappropriate handling or storage could range from performance degradation to complete failure.

## Applications Information

### Power Consumption

The HCPL-90xx and HCPL-09xx CMOS digital isolators achieves low power consumption from the manner by which they transmit data across isolation barrier. By detecting the edge transitions of the input logic signal and converting this to a narrow current pulse, which drives the isolation barrier, the isolator then latches the input logic state in the output latch. Since the current pulses are narrow, about 2.5 ns wide, the power consumption is independent of mark-to-space ratio and solely dependent on frequency.

The approximate power supply current per channel is:  
 $I(\text{Input}) = 40(f/f_{\text{max}})(1/4) \text{ mA}$

where  $f$  = operating frequency,  $f_{\text{max}} = 50 \text{ MHz}$ .

### Signal Status on Start-up and Shut Down

To minimize power dissipation, the input signals to the channels of HCPL-90xx and HCPL-09xx digital isolators are differentiated and then latched on the output side of the isolation barrier to reconstruct the signal. This could result in an ambiguous output state depending on power up, shutdown and power loss sequencing. Therefore, the designer should consider the inclusion of an initialization signal in this start-up circuit. Initialization consists of toggling the input either high then low or low then high.

## Bypassing and PC Board Layout

The HCPL-90xx and HCPL-09xx digital isolators are extremely easy to use. No external interface circuitry is required because the isolators use high-speed CMOS IC technology allowing CMOS logic to be connected directly to the inputs and outputs. As shown in Figure 1, the only external components required for proper operation are two 47 nF ceramic capacitors for decoupling the power supplies. For each capacitor, the total lead length between both ends of the capacitor and the power-supply pins should not exceed 20 mm. Figure 2 illustrates the recommended printed circuit board layout for the HCPL-9000 or HCPL-0900. For data rates in excess of 10MBd, use of ground planes for both  $\text{GND}_1$  and  $\text{GND}_2$  is highly recommended.

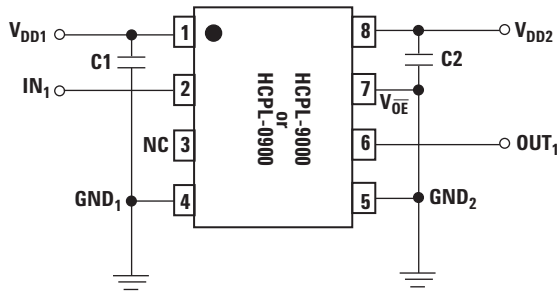

Note: C1, C2 = 47 nF ceramic capacitors

Figure 1. Functional Diagram of Single Channel HCPL-0900 or HCPL-9000.

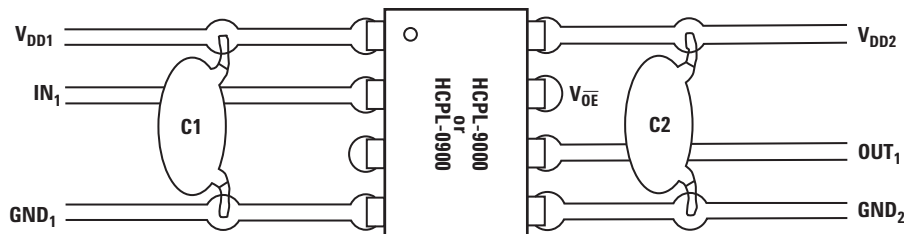

Figure 2. Recommended Printed Circuit Board Layout.

### Propagation Delay, Pulse Width Distortion and Propagation Delay Skew

Propagation Delay is a figure of merit, which describes how quickly a logic signal propagates through a system as illustrated in Figure 3.



Figure 3. Timing Diagrams to Illustrate Propagation Delay,  $t_{PLH}$  and  $t_{PHL}$ .

The propagation delay from low to high,  $t_{PLH}$ , is the amount of time required for an input signal to propagate to the output, causing the output to change from low to high. Similarly, the propagation delay from high to low,  $t_{PHL}$ , is the amount of time required for the input signal to propagate to the output, causing the output to change from high to low.

Pulse Width Distortion, PWD, is the difference between  $t_{PHL}$  and  $t_{PLH}$  and often determines the maximum data rate capability of a transmission system. PWD can be expressed in percent by dividing the PWD (in ns) by the minimum pulse width (in ns) being transmitted. Typically, PWD on the order of 20–30% of the minimum pulse width is tolerable.

Propagation Delay Skew,  $t_{PSK}$ , and Channel-to-Channel Skew,  $t_{CSK}$ , are critical parameters to consider in parallel data transmission applications where synchronization of signals on parallel data lines is a concern. If the parallel data is being sent through channels of the digital isolators, differences in propagation delays will cause the data to arrive at the outputs of the digital isolators at different times. If this difference in propagation delay is large enough, it will limit the maximum transmission rate at which parallel data can be sent through the digital isolators.

$t_{PSK}$  is defined as the difference between the minimum and maximum propagation delays, either  $t_{PLH}$  or  $t_{PHL}$ , among two or more devices which are operating under the same conditions (i.e., the same drive current, supply voltage, output load, and operating temperature).  $t_{CSK}$  is defined as the difference between the minimum and maximum propagation delays, either  $t_{PLH}$  or  $t_{PHL}$ , among two or more channels within a single device (applicable to dual and quad channel devices) which are operating under the same conditions.

As illustrated in Figure 4, if the inputs of two or more devices are switched either ON or OFF at the same time,  $t_{PSK}$  is the difference between the minimum propagation delay, either  $t_{PLH}$  or  $t_{PHL}$ , and the maximum propagation delay, either  $t_{PLH}$  or  $t_{PHL}$ .



Figure 4. Timing Diagrams to Illustrate Propagation Delay Skew.

As mentioned earlier,  $t_{PSK}$  can determine the maximum parallel data transmission rate. Figure 5 shows the timing diagram of a typical parallel data transmission application with both the clock and data lines being sent through the digital isolators. The figure shows data and clock signals at the inputs and outputs of the digital isolators. In this case, the data is clocked off the rising edge of the clock.



Figure 5. Parallel Data Transmission.

Propagation delay skew represents the uncertainty of where an edge might be after being sent through a digital isolator. Figure 5 shows that there will be uncertainty in both the data and clock lines. It is important that these two areas of uncertainty not overlap, otherwise the clock signal might arrive before all of the data outputs have settled, or some of the data outputs may start to change before the clock signal has arrived. From these considerations, the absolute minimum pulse width that can be

sent through digital isolators in a parallel application is twice  $t_{PSK}$ . A cautious design should use a slightly longer pulse width to ensure that any additional uncertainty in the rest of the circuit does not cause a problem.

Figure 6 shows the minimum pulse width, rise and fall time, and propagation delay enable to output waveforms for HCPL-9000 or HCPL-0900.



Figure 6. Timing Diagrams to Illustrate the Minimum Pulse Width, Rise and Fall Time, and Propagation Delay Enable to Output Waveforms for HCPL-9000 or HCPL-0900.

For product information and a complete list of distributors, please go to our web site: [www.avagotech.com](http://www.avagotech.com)

Avago, Avago Technologies, and the A logo are trademarks of Avago Technologies in the United States and other countries. Data subject to change. Copyright © 2005-2011 Avago Technologies. All rights reserved. Obsoletes 5989-0803EN AV02-0137EN - May 30, 2011





Компания «ЭлектроПласт» предлагает заключение долгосрочных отношений при поставках импортных электронных компонентов на взаимовыгодных условиях!

Наши преимущества:

- Оперативные поставки широкого спектра электронных компонентов отечественного и импортного производства напрямую от производителей и с крупнейших мировых складов;
- Поставка более 17-ти миллионов наименований электронных компонентов;
- Поставка сложных, дефицитных, либо снятых с производства позиций;
- Оперативные сроки поставки под заказ (от 5 рабочих дней);
- Экспресс доставка в любую точку России;
- Техническая поддержка проекта, помощь в подборе аналогов, поставка прототипов;
- Система менеджмента качества сертифицирована по Международному стандарту ISO 9001;
- Лицензия ФСБ на осуществление работ с использованием сведений, составляющих государственную тайну;
- Поставка специализированных компонентов (Xilinx, Altera, Analog Devices, Intersil, Interpoint, Microsemi, Aeroflex, Peregrine, Syfer, Eurofarad, Texas Instrument, Miteq, Cobham, E2V, MA-COM, Hittite, Mini-Circuits, General Dynamics и др.);

Помимо этого, одним из направлений компании «ЭлектроПласт» является направление «Источники питания». Мы предлагаем Вам помощь Конструкторского отдела:

- Подбор оптимального решения, техническое обоснование при выборе компонента;
- Подбор аналогов;
- Консультации по применению компонента;
- Поставка образцов и прототипов;
- Техническая поддержка проекта;
- Защита от снятия компонента с производства.



#### Как с нами связаться

**Телефон:** 8 (812) 309 58 32 (многоканальный)

**Факс:** 8 (812) 320-02-42

**Электронная почта:** [org@eplast1.ru](mailto:org@eplast1.ru)

**Адрес:** 198099, г. Санкт-Петербург, ул. Калинина, дом 2, корпус 4, литера А.