

DATA SHEET

SKY65045-70LF: 390 to 1500 MHz Low-Noise Power Amplifier Driver

Applications

- UHF television
- TETRA radio
- GSM, AMPS, PCS, DCS, 2.5G, 3G
- ISM band transmitters
- Fixed WCS
- 802.16 WiMAX
- 3GPP Long Term Evolution

Features

- Wideband frequency range: 390 to 1500 MHz
- Low Noise Figure: 1.8 dB
- High linearity OIP3: +37.5 dBm
- OP1dB = +25 dBm
- High gain: 14 dB
- Single DC supply: +5 V
- On-chip bias circuit
- SOT-89 (4-pin 2.4 x 4.5 mm) Pb-free package (MSL1, 260 °C per JEDEC J-STD-0-20)



Skyworks Green™ products are compliant with all applicable legislation and are halogen-free. For additional information, refer to *Skyworks Definition of Green™*, document number SQ04-0074.

Description

Skyworks SKY65045-70LF is a high performance, ultra-wideband Power Amplifier (PA) driver with superior output power, low noise, linearity, and efficiency. The device provides a 1.6 dB Noise Figure (NF) and an output power at 1 dB compression of +25 dBm, making the SKY65045-70LF ideal for use in the driver stage of infrastructure transmit chains.

The SKY65045-70LF is fabricated with Skyworks high reliability Heterojunction Bipolar Transistor (HBT) process. The device uses low-cost Surface-Mount Technology (SMT) in the form of a 2.4 x 4.5 mm Small Outline Transistor (SOT-89) package. The module can operate over a temperature range of -40 °C to +85 °C. A populated Evaluation Board is available upon request.

The device package and pinout are shown in Figure 1. A functional block diagram is provided in Figure 2.

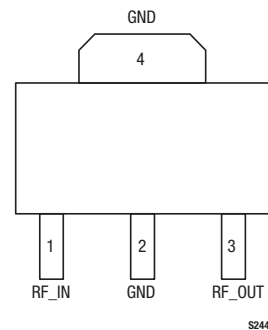

Figure 1. SKY65045-70LF Pinout Package (Top View)

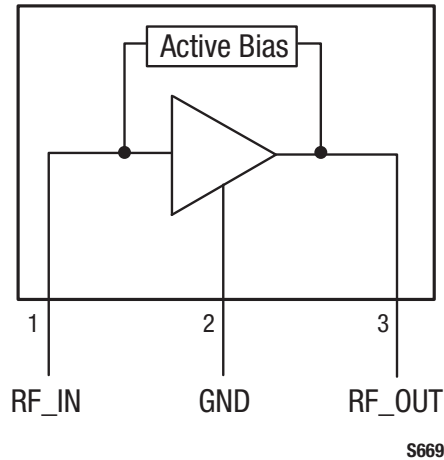

Figure 2. SKY65045-70LF Block Diagram

Technical Description

The SKY65045-70LF is a single stage, low noise PA in a low-cost surface mount package. The device operates with a single +5 V power supply connected through an RF choke (L1) to the output pin. Capacitors C7, C8, and C9 provide DC bias decoupling for VCC.

The bias current is set by the on-chip active bias composed of current mirror and reference voltage transistors, allowing for excellent gain tracking over temperature and voltage variations. The part is externally RF matched using surface mount components to facilitate operation over a frequency range of 390 MHz to 1500 MHz.

Pin 1 is the RF input and pin 3 is the RF output. External DC blocking is required for both input and output, but can be implemented as part of the RF matching circuit. Pin 2 and the package backside metal, pin 4, provide the DC and RF ground.

Electrical and Mechanical Specifications

Signal pin assignments and functional pin descriptions for the SKY65045-70LF are provided in Table 1. The absolute maximum ratings are provided in Table 2, and the recommended operating conditions in Table 3. Electrical characteristics for the SKY65045-70LF are provided in Table 4.

Typical performance characteristics of the SKY65045-70LF are illustrated in Figures 3 through 61 and in Tables 5 through 10. The board layout footprint for the SKY65045-70LF is shown in Figure 66. Package dimensions are shown in Figure 67, and tape and reel dimensions are shown in Figure 68.

Package and Handling Information

Instructions on the shipping container label regarding exposure to moisture after the container seal is broken must be followed. Otherwise, problems related to moisture absorption may occur when the part is subjected to high temperature during solder assembly.

The SKY65045-70LF is rated to Moisture Sensitivity Level 1 (MSL1) at 260 °C. It can be used for lead or lead-free soldering. For additional information, refer to the Skyworks Application Note, *Solder Reflow Information*, document number 200164.

Care must be taken when attaching this product, whether it is done manually or in a production solder reflow environment. Production quantities of this product are shipped in a standard tape and reel format.

Table 1. SKY65045 Signal Descriptions

Pin	Name	Description
1	RF_IN	RF input
2	GND	Ground
3	RF_OUT	RF output
4	GND	Ground

Table 2. SKY65045 Absolute Maximum Ratings¹
(T_A = +25 °C, Unless Otherwise Noted)

Parameter	Symbol	Min	Typical	Max	Units
RF output power	P _{OUT}		+27		dBm
Supply voltage	VCC		6		V
Supply current	I _{CC}		215		mA
Power dissipation	P _D		1.3		W
Operating case temperature	T _C	-40		+85	°C
Storage temperature	T _{ST}	-55		+125	°C
Junction temperature	T _J			150	°C

¹ Exposure to maximum rating conditions for extended periods may reduce device reliability. There is no damage to device with only one parameter set at the limit and all other parameters set at or below their nominal values.

ESD HANDLING: Although this device is designed to be as robust as possible, electrostatic discharge (ESD) can damage this device. This device must be protected at all times from ESD when handling or transporting. Static charges may easily produce potentials of several kilovolts on the human body or equipment, which can discharge without detection. Industry-standard ESD handling precautions should be used at all times.

Table 3. SKY65045 Recommended Operating Conditions

Parameter	Symbol	Min	Typical	Max	Units
Supply voltage	VCC		5	5.5	V
Frequency range	f	390		1500	MHz
Operating case temperature	T _C	-40	+25	+85	°C

Table 4. SKY65045 Electrical Characteristics¹
(VCC = 5.0 V, Output Impedance = 50 Ω, Tc = 25 °C, Unless Otherwise Noted)

Parameter	Symbol	Test Conditions	Min	Typical	Max	Units
Test Frequency = 747 MHz						
Frequency	f		697	747	797	MHz
Small signal gain	G	P _{IN} = -15 dBm		15		dB
Input return loss	S11	P _{IN} = -15 dBm		9		dB
Output return loss	S22	P _{IN} = -15 dBm		8		dB
Reverse transmission loss	S12	P _{IN} = -15 dBm		23		dB
Output power @ 1 dB compression	P _{1dB}	CW		+24		dBm
Operating current	I _{CC}	P _{OUT} = +17 dBm		70		mA
Operating current	I _{CC_P1dB}	@ P1dB		132		mA
Power-added efficiency	PAE	@ P1dB		35		%
Input 3rd order intercept point	IIP3	P _{IN} /tone = -10 dBm, ΔF = 1 MHz		+29		dBm
Output 3rd order intercept point	OIP3	P _{OUT} /tone = +8 dBm, ΔF = 1 MHz		+44		dBm
Noise figure	NF	Small signal		1.9		dB
Quiescent current ²	I _{CO}	No RF		47		mA
Test Frequency = 897.5 MHz						
Frequency	f		880.0	897.5	915.0	MHz
Small signal gain	G	P _{IN} = -15 dBm	13	14	16	dB
Input return loss	S11	P _{IN} = -15 dBm		12.2	10.0	dB
Output return loss	S22	P _{IN} = -15 dBm		19.5	10.0	dB
Reverse transmission loss	S12	P _{IN} = -15 dBm		21	15	dB
Output power @ 1 dB compression	P _{1dB}	CW	+22.5	+25.0		dBm
Operating current	I _{CC}	P _{OUT} = +17 dBm		61	90	mA
Operating current	I _{CC_P1dB}	@ P1dB		133	180	mA
Power-added efficiency	PAE	@ P1dB		45		%
Output 3rd order intercept point	OIP3	P _{OUT} /tone = +17 dBm, ΔF = 1 MHz	+36.0	+37.5		dBm
Noise figure	NF	Small signal		1.8	2.4	dB
Quiescent current ²	I _{CO}	No RF		46	60	mA

¹ Performance is guaranteed only under the conditions listed in this table.

² Different I_{CO} values are induced by different winding resistances in power inductor L5 (3.3 nH vs 39 nH).

Typical Performance Data

(VCC = 5 V, f = 747 MHz, CW, Output Impedance = 50 Ω, Tc = 25 °C, Unless Otherwise Noted)

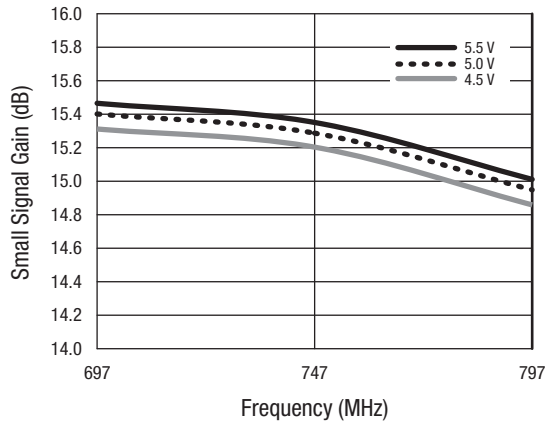

Figure 3. Small Signal Gain vs Frequency Over VCC

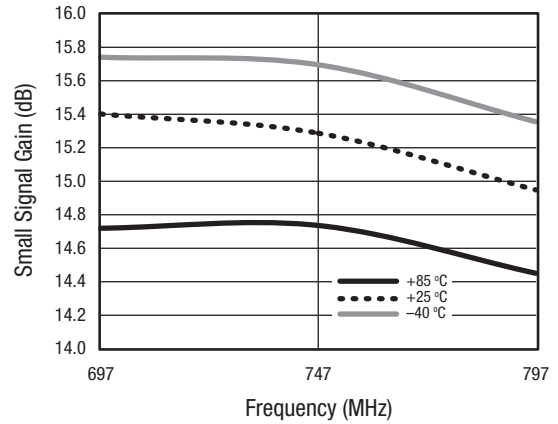

Figure 4. Small Signal Gain vs Frequency Over Temperature

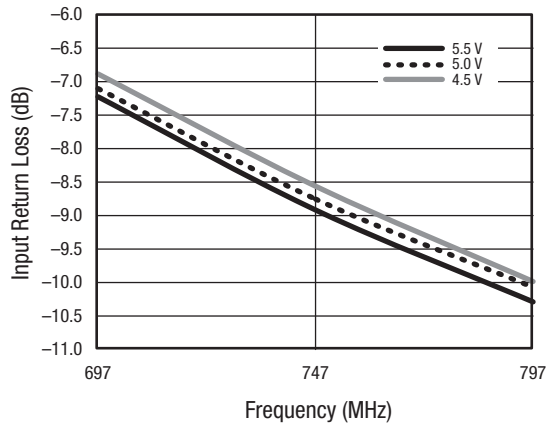

Figure 5. Input Return Loss vs Frequency Over VCC

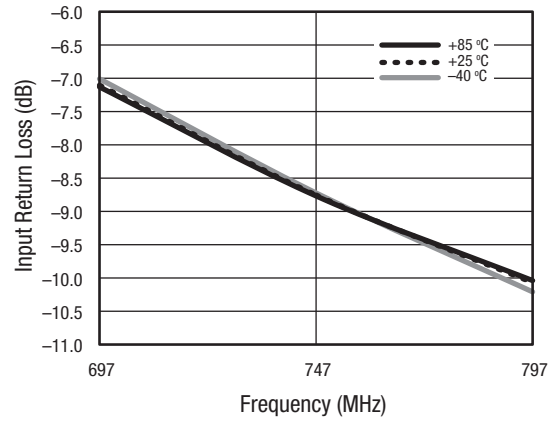

Figure 6. Input Return Loss vs Frequency Over Temperature

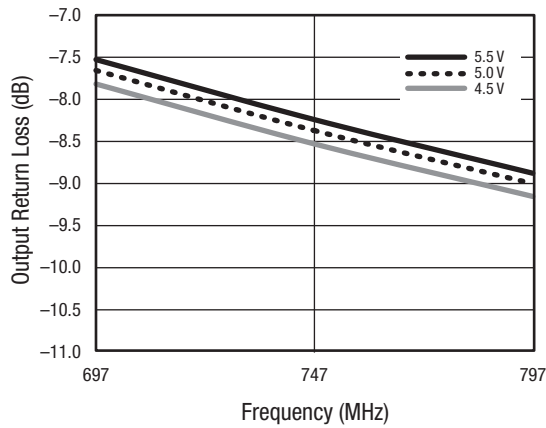

Figure 7. Output Return Loss vs Frequency Over VCC

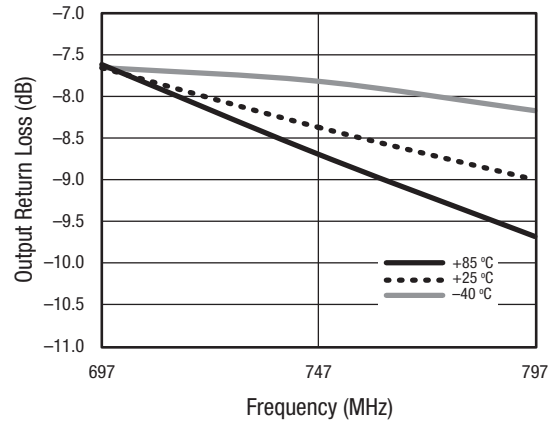

Figure 8. Output Return Loss vs Frequency Over Temperature

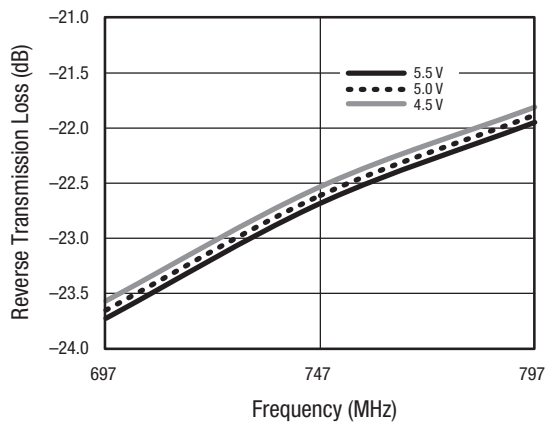

Figure 9. Reverse Transmission Loss vs Frequency Over VCC

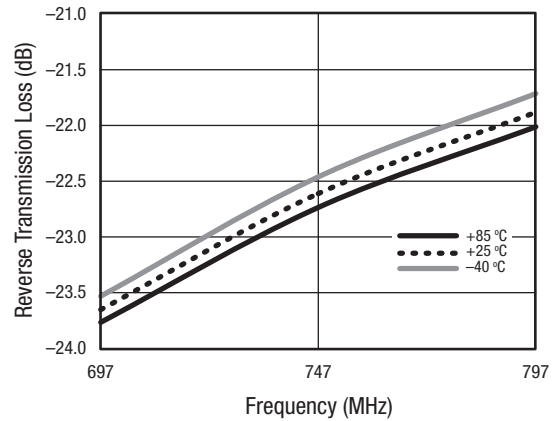

Figure 10. Reverse Transmission Loss vs Frequency Over Temperature

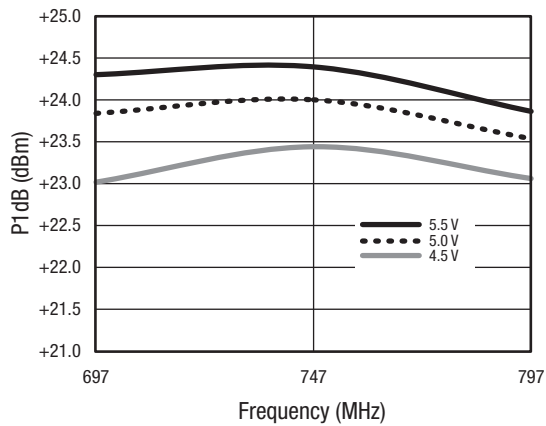

Figure 11. P1dB vs Frequency Over VCC

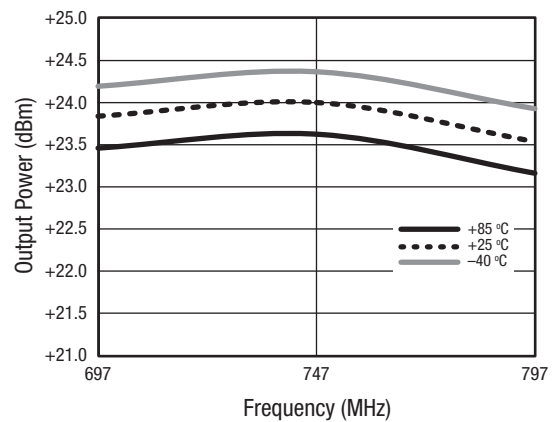

Figure 12. P1dB vs Frequency Over Temperature

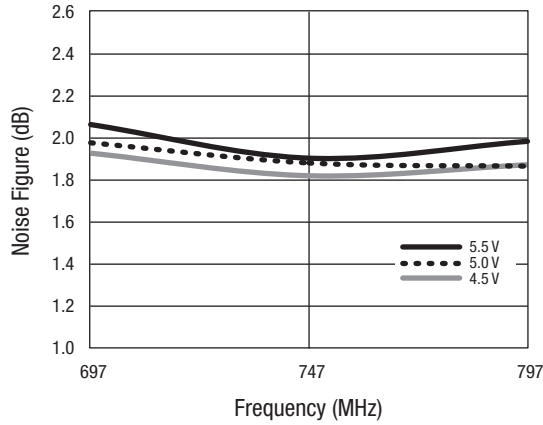

Figure 13. Noise Figure vs Frequency Over VCC

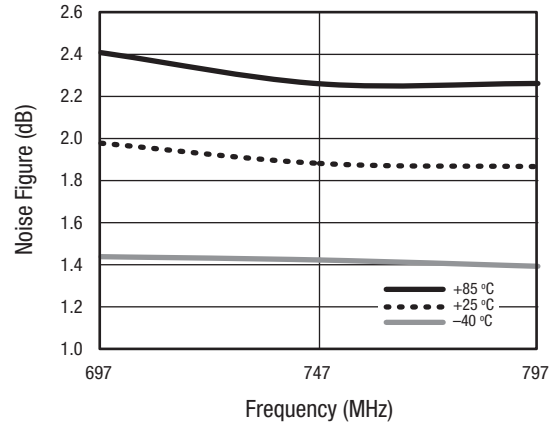

Figure 14. Noise Figure vs Frequency Over Temperature

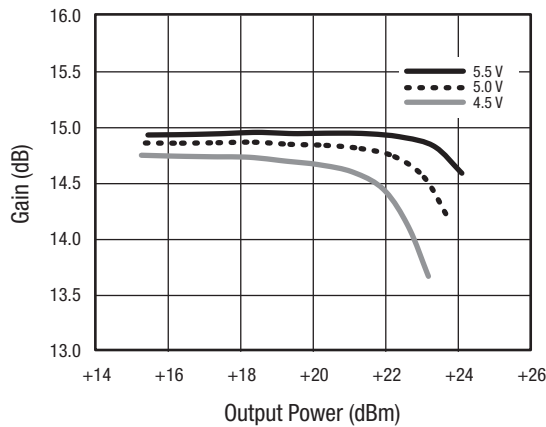

Figure 15. Gain vs Output Power Over VCC

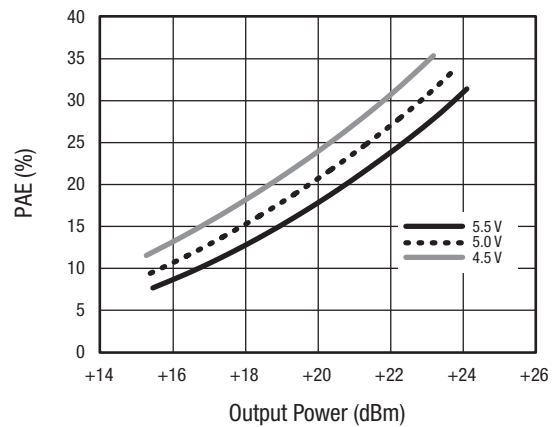

Figure 16. PAE vs Output Power Over VCC

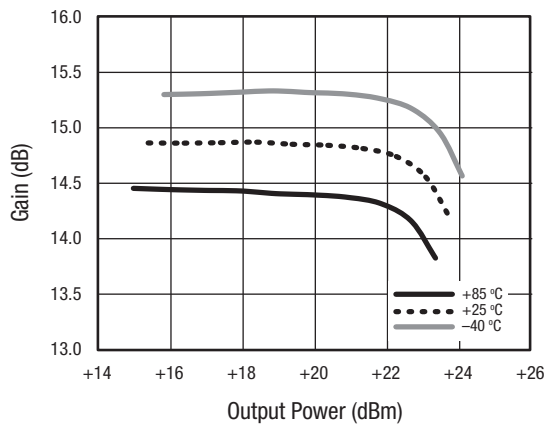

Figure 17. Gain vs Output Power Over Temperature

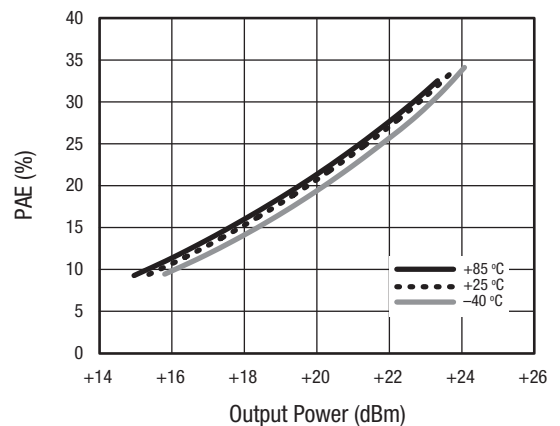

Figure 18. PAE vs Output Power Over Temperature

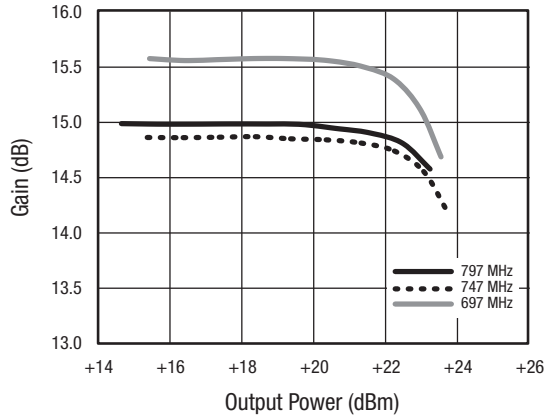

Figure 19. Gain vs Output Power Over Frequency

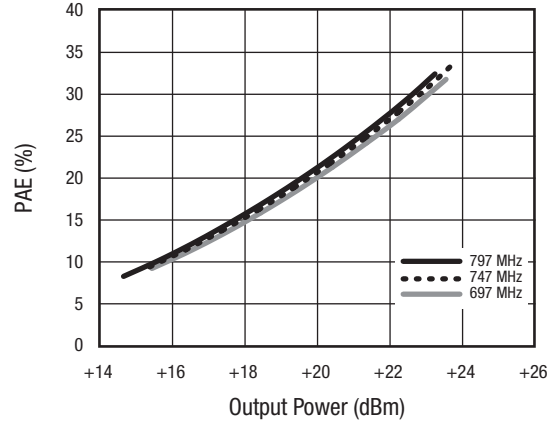

Figure 20. PAE vs Output Power Over Frequency

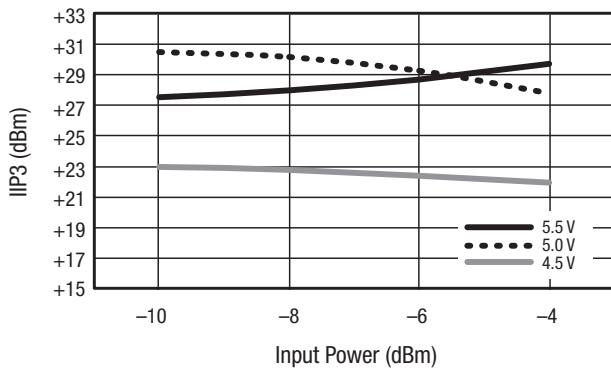

Figure 21. IIP3 vs Input Power Over VCC

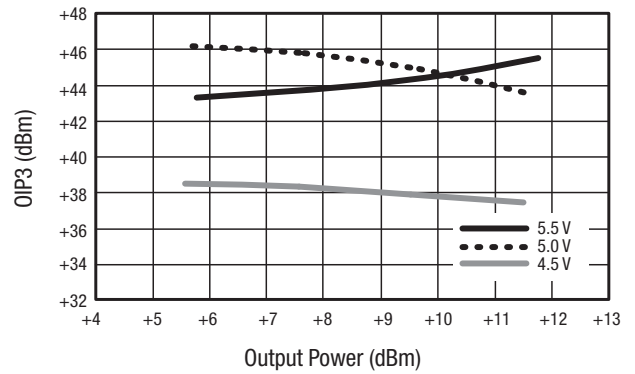

Figure 22. OIP3 vs Output Power Over VCC

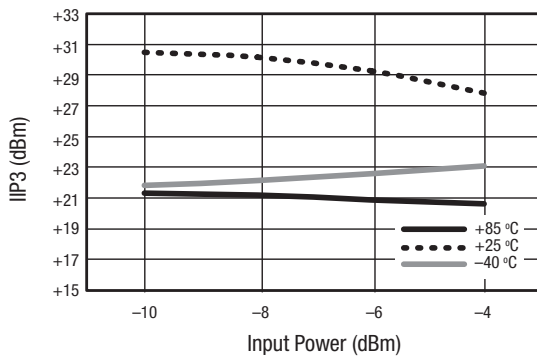

Figure 23. IIP3 vs Input Power Over Temperature

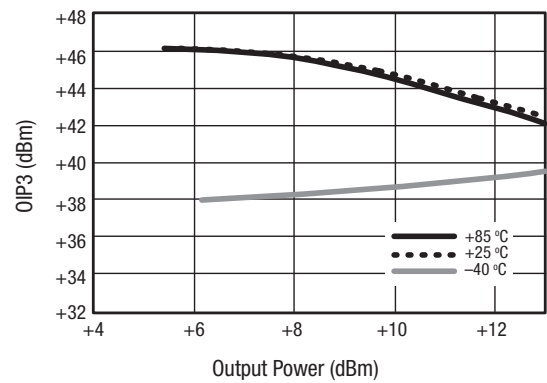

Figure 24. OIP3 vs Output Power Over Temperature

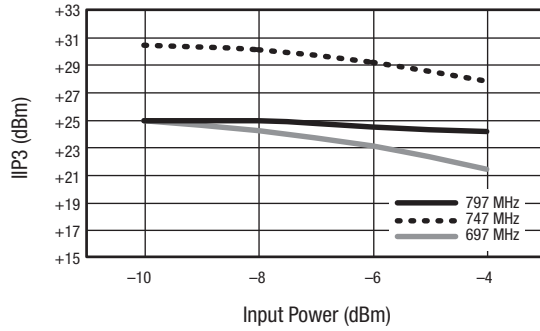

Figure 25. IIP3 vs Input Power Over Frequency

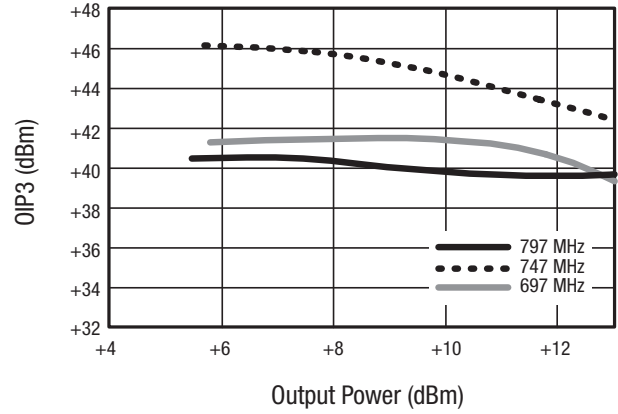

Figure 26. OIP3 vs Output Power Over Frequency

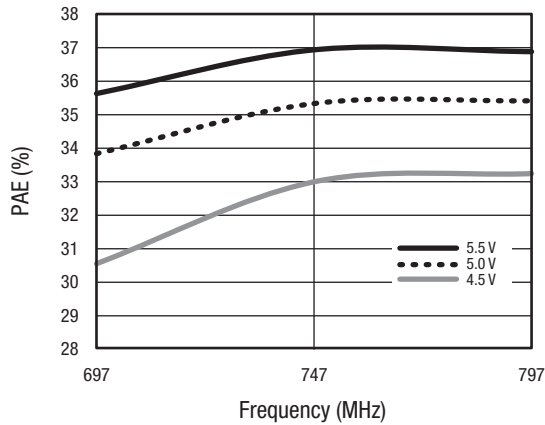

Figure 27. PAE @ P1dB vs Frequency Over VCC

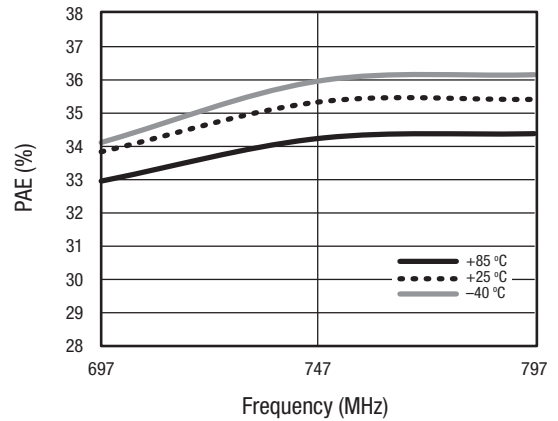

Figure 28. PAE @ P1dB vs Frequency Over Temperature

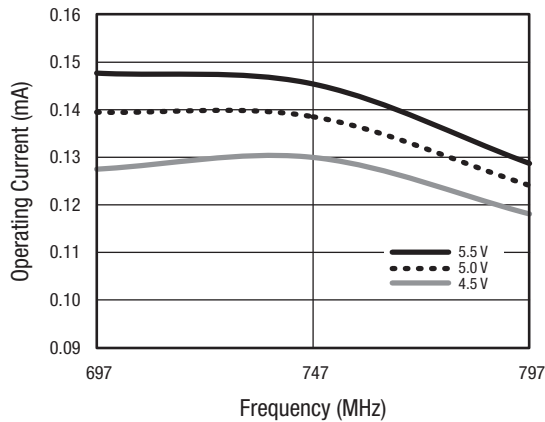

Figure 29. Operating Current @ P1dB vs Frequency Over VCC

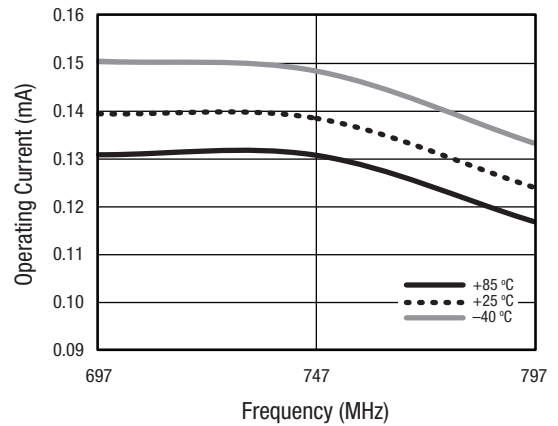

Figure 30. Operating Current @ P1dB vs Frequency Over Temperature

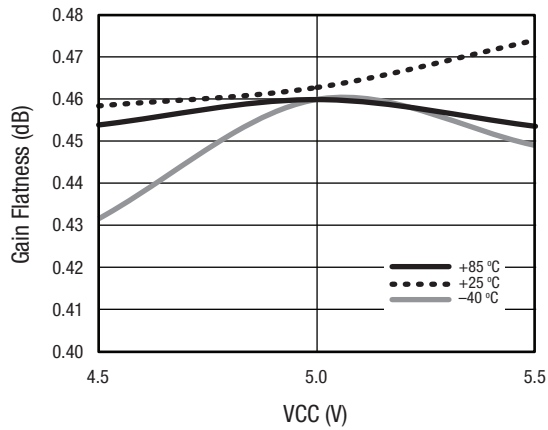

Figure 31. Gain Flatness vs VCC Over Temperature

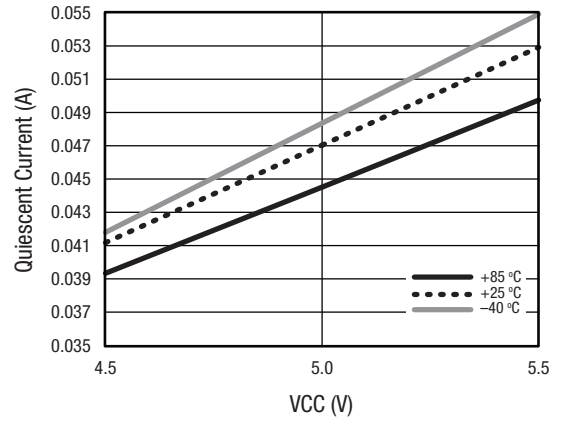

Figure 32. Quiescent Current vs VCC Over Temperature

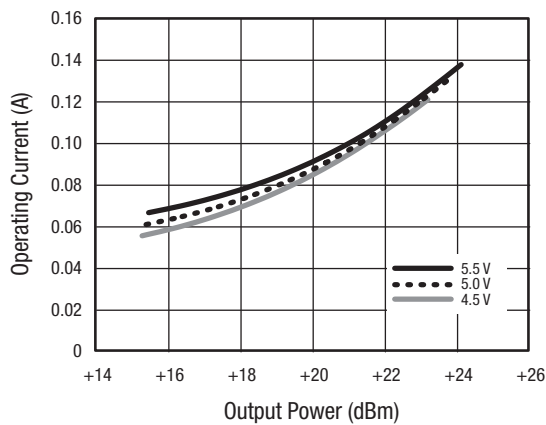

Figure 33. Operating Current vs Output Power Over VCC

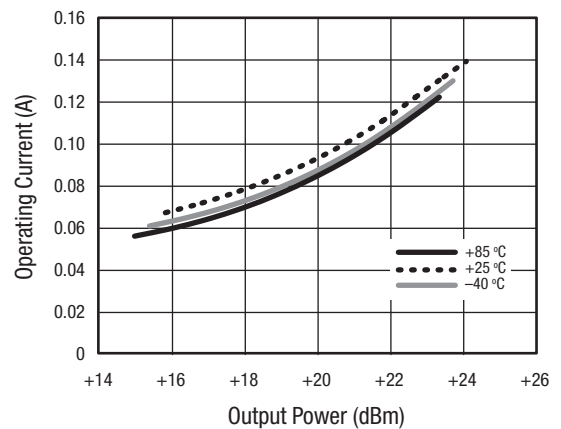

Figure 34. Operating Current vs Output Power Over Temperature

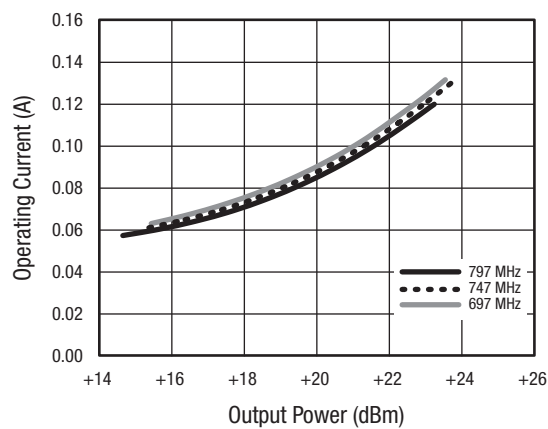

Figure 35. Operating Current vs Output Power Over Frequency

Typical Performance Data

(VCC = 5 V, f = 897.5 MHz, CW, Output Impedance = 50 Ω, Tc = 25 °C, Unless Otherwise Noted)

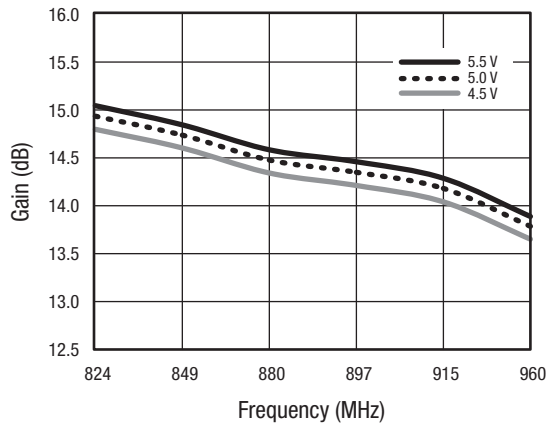

Figure 36. Small Signal Gain vs Frequency Over VCC

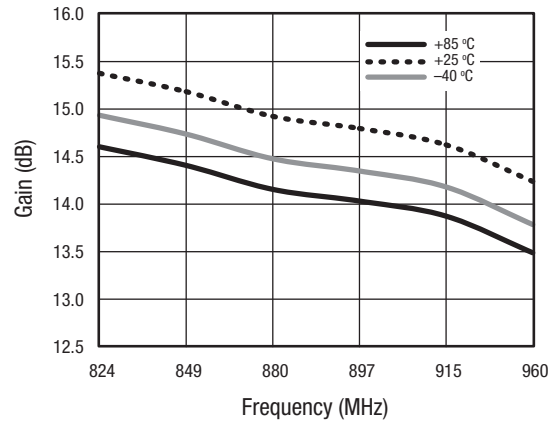

Figure 37. Small Signal Gain vs Frequency Over Temperature

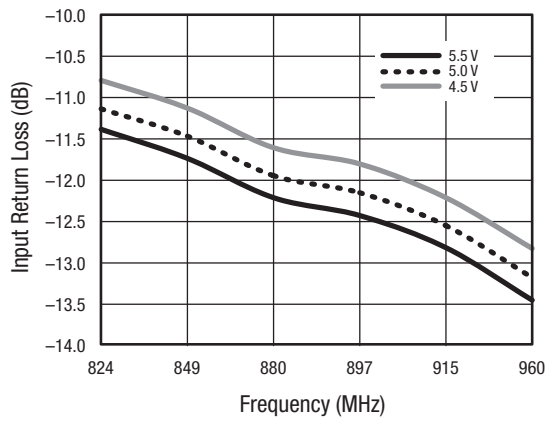

Figure 38. Input Return Loss vs Frequency Over VCC

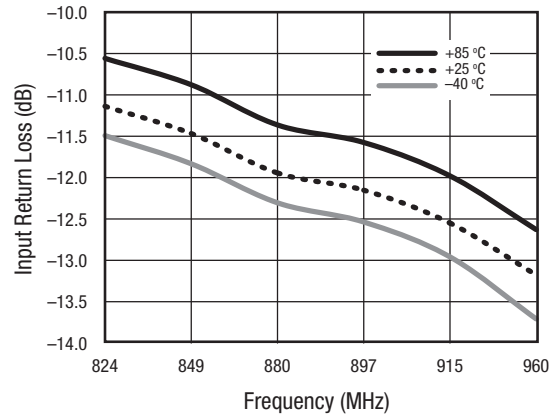

Figure 39. Input Return Loss vs Frequency Over Temperature

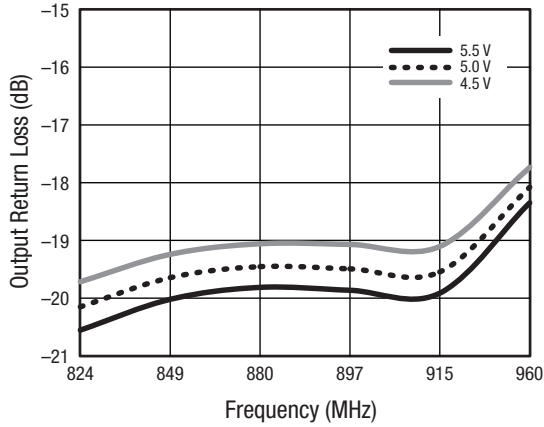

Figure 40. Output Return Loss vs Frequency Over VCC

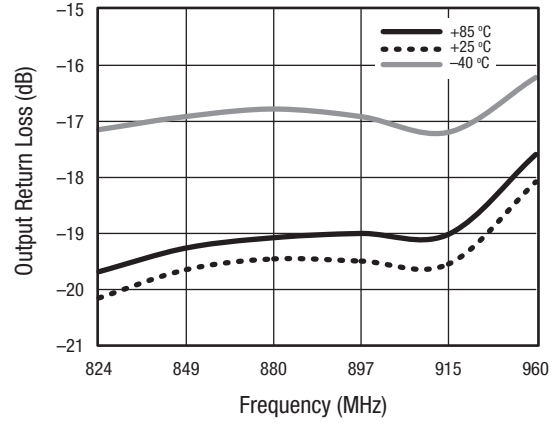

Figure 41. Output Return Loss vs Frequency Over Temperature

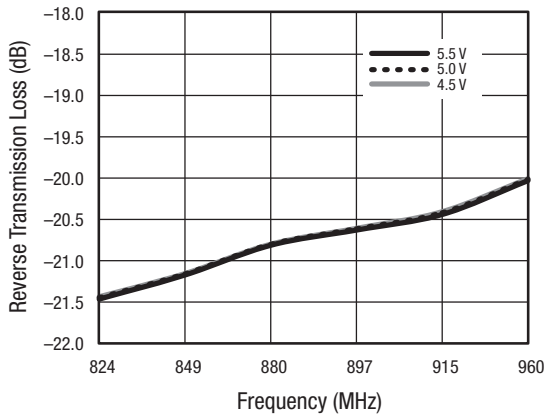

Figure 42. Reverse Transmission Loss vs Frequency Over VCC

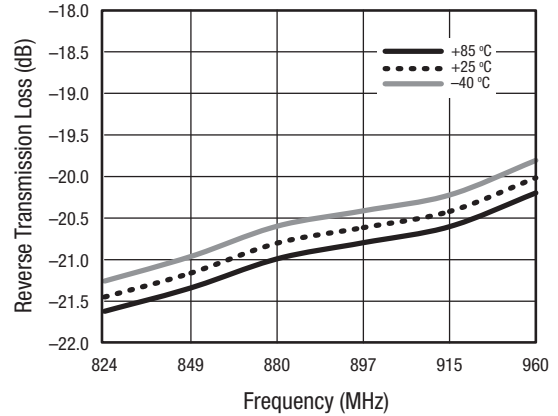

Figure 43. Reverse Transmission Loss vs Frequency Over Temperature

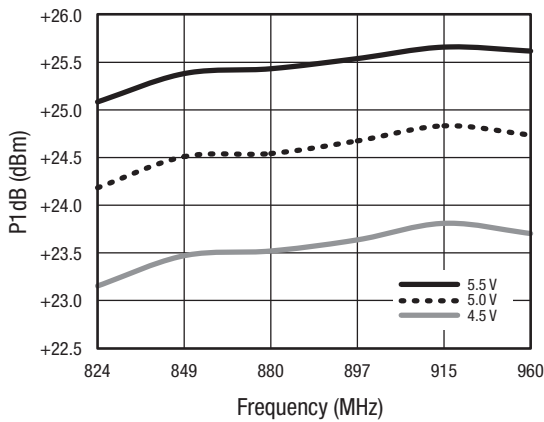

Figure 44. P1dB vs Frequency Over VCC

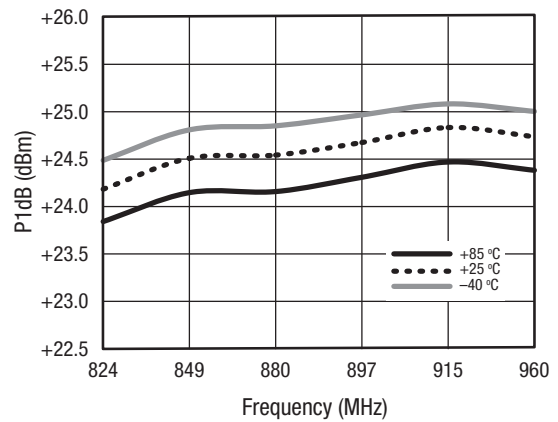

Figure 45. P1dB vs Frequency Over Temperature

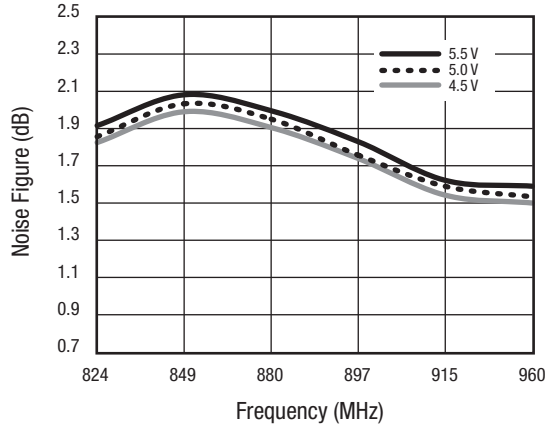

Figure 46. Noise Figure vs Frequency Over VCC

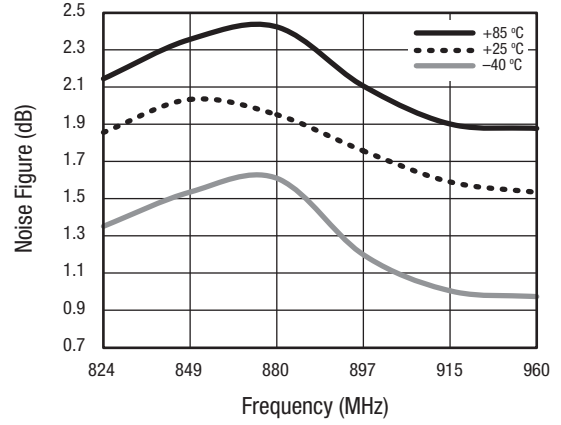

Figure 47. Noise Figure vs Frequency Over Temperature

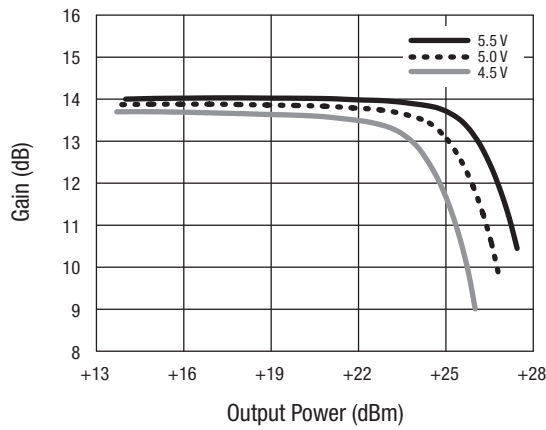

Figure 48. Gain vs Output Power Over VCC

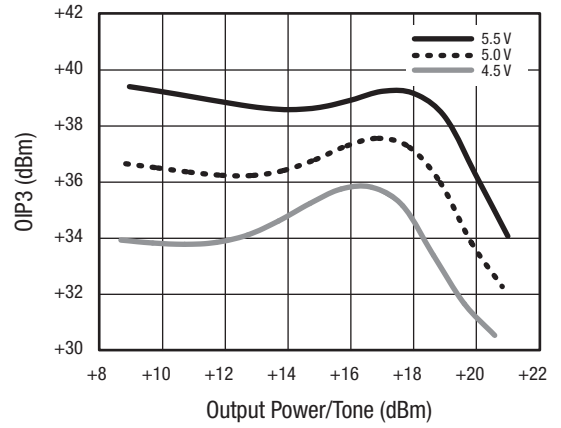

Figure 49. OIP3 vs Output Power/Tone Over VCC

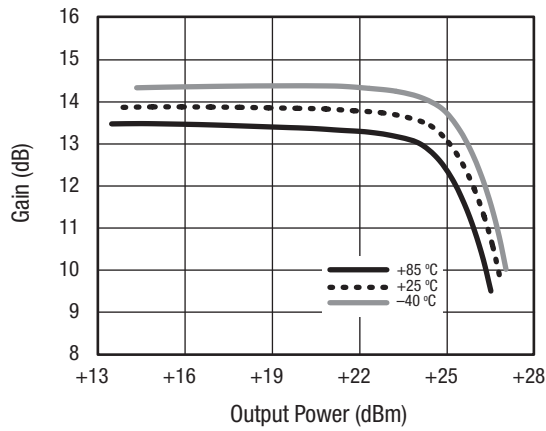

Figure 50. Gain vs Output Power Over Temperature

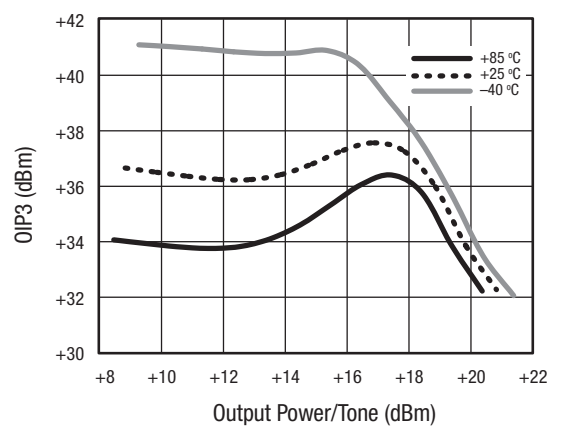

Figure 51. OIP3 vs Output Power/Tone Over Temperature

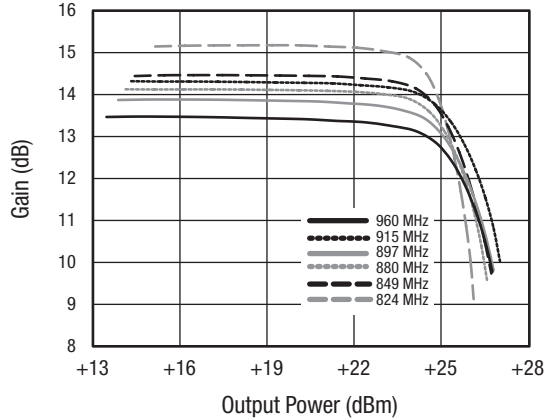

Figure 52. Gain vs Output Power Over Frequency

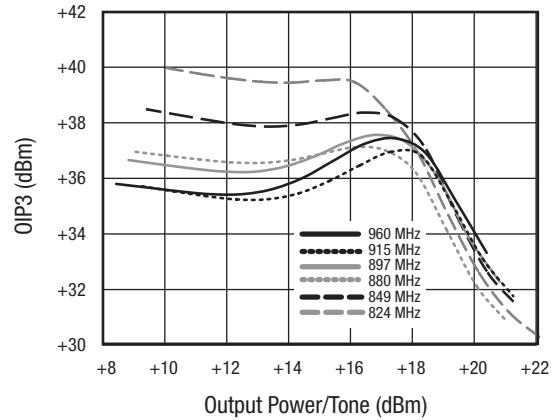

Figure 53. OIP3 vs Output Power/Tone Over Frequency

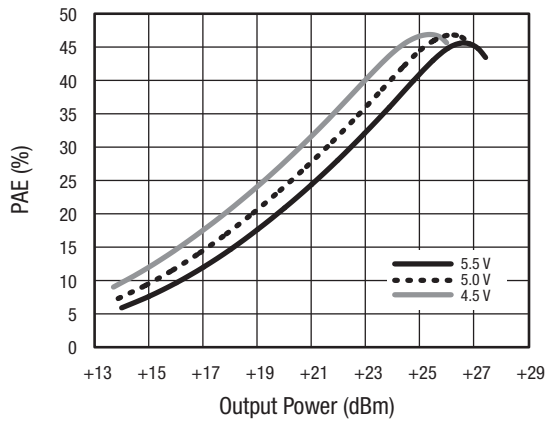

Figure 54. PAE vs Output Power Over VCC

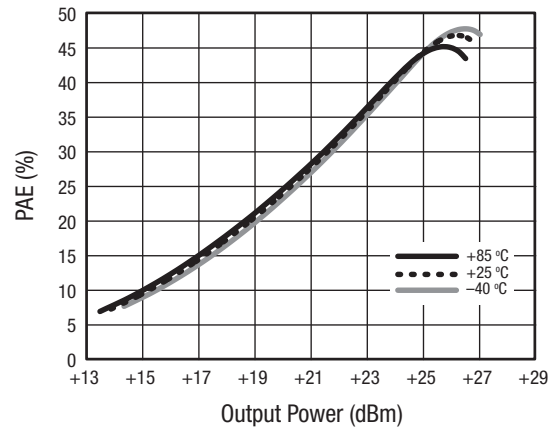

Figure 55. PAE vs Output Power Over Temperature

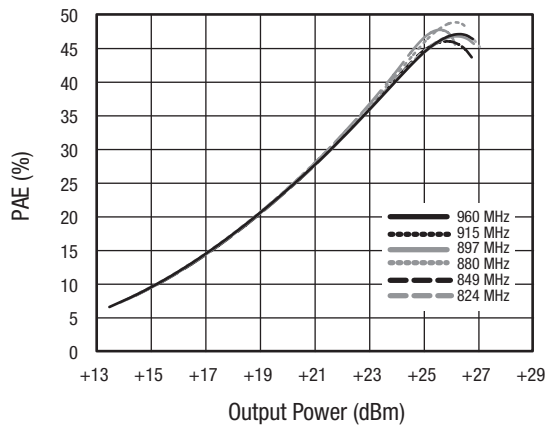

Figure 56. PAE vs Output Power Over Frequency

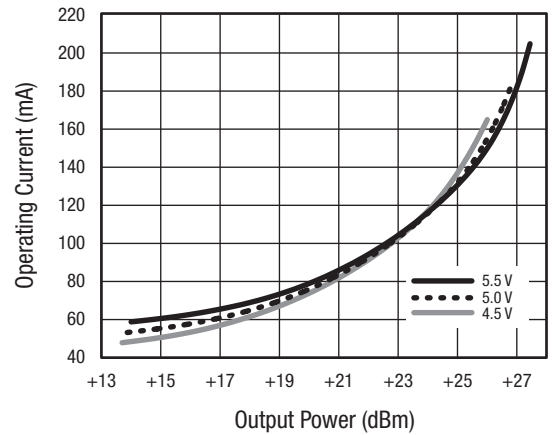

Figure 57. Operating Current vs Output Power Over VCC

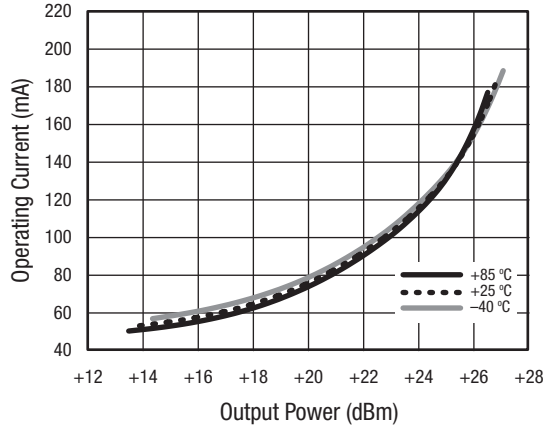

Figure 58. Operating Current vs Output Power Over Temperature

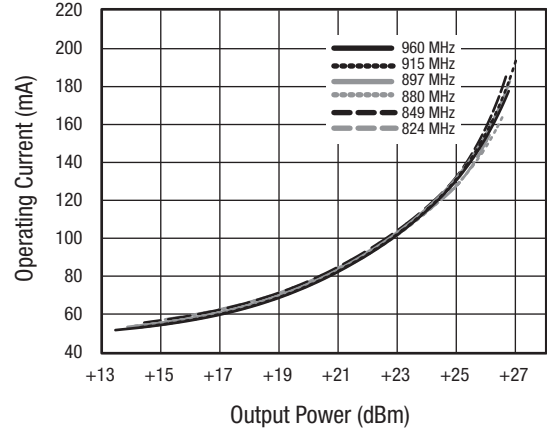

Figure 59. Operating Current vs Output Power Over Frequency

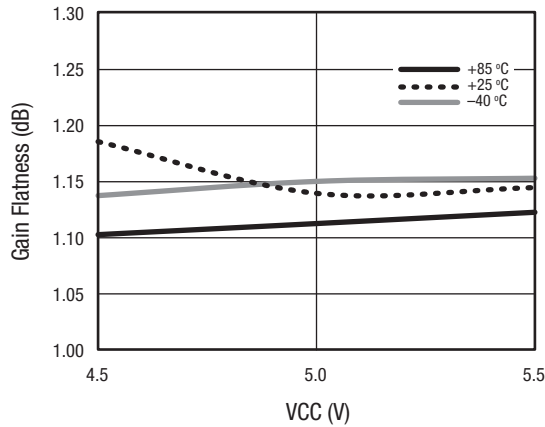

Figure 60. Gain Flatness vs VCC Over Temperature

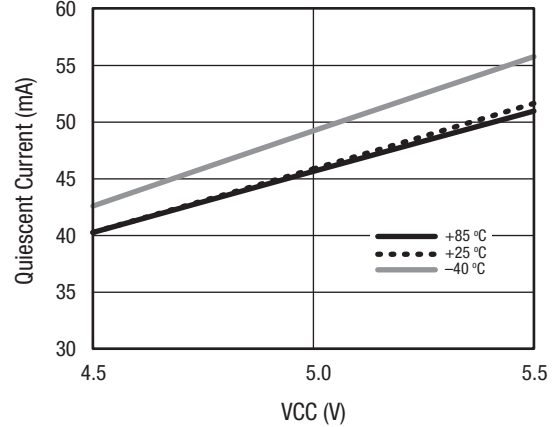

Figure 61. Quiescent Current vs VCC Over Temperature

Table 5. PAE Performance @ P1dB vs Output Power Over VCC

VCC (V)	PAE @ P1dB (%)	Pout (dBm)
4.5	43.9	+23.9
5.0	44.8	+25.1
5.5	45.0	+26.1

Table 6. PAE Performance @ P1dB vs Output Power Over Temperature

Temperature (°C)	PAE @ P1dB (%)	Pout (dBm)
-40	45.8	+25.38
+25	44.5	+25.04
+85	43.3	+24.65

Table 7. PAE Performance @ P1dB vs Output Power Over Frequency

Frequency (MHz)	PAE @ P1dB (%)	Pout (dBm)
824	46.3	+24.92
849	45.5	+25.24
880	46.5	+25.13
897	44.7	+25.04
915	45.8	+25.35
960	45.8	+25.38

Table 8. Supply Current Performance @ P1dB vs Output Power Over VCC

VCC (V)	Operating Current (mA)	Pout (dBm)
4.5	117	+23.9
5.0	133	+25.1
5.5	152	+26.1

Table 9. Supply Current Performance @ P1dB vs Output Power Over Temperature

Temperature (°C)	Operating Current (mA)	Pout (dBm)
-40	142	+25.42
+25	133	+25.05
+85	125	+24.65

Table 10. Supply Current Performance @ P1dB vs Output Power Over Frequency

Frequency (MHz)	Operating Current (mA)	Pout (dBm)
824	126	+24.92
849	137	+25.26
880	130	+25.14
897	133	+25.06
915	139	+25.34
960	138	+25.38

Evaluation Board Description

The Skyworks SKY65045 Evaluation Board is used to test the performance of the SKY65045-70LF PA driver. The Evaluation Board schematic diagram is shown in Figure 62. An assembly drawing for the Evaluation Board is shown in Figure 63 and the layer detail is provided in Figure 64. The layer detail physical characteristics are noted in Figure 65. Tables 11 and 12 (747 MHz and 897.5 MHz, respectively) provide the Bill of Materials (BOM) list for Evaluation Board components.

Circuit Design Configurations

The following design considerations are general in nature and must be followed regardless of final use or configuration:

1. Paths to ground should be made as short as possible.
2. The ground pad of the SKY65045-70LF has special electrical and thermal grounding requirements. This pad is the main thermal conduit for heat dissipation. Since the circuit board acts as the heat sink, it must shunt as much heat as possible from the device. Therefore, design the connection to the ground pad to dissipate the maximum wattage produced by the circuit board. Multiple vias to the grounding layer are required.

3. Skyworks recommends including external bypass capacitors on the DC supply lines. An RF inductor is required on the VCC supply line to block RF signals from the DC supply. Refer to Figure 62 for more detail.
4. The RF lines should be well separated from each other with solid ground in between traces to maximize input-to-output isolation.

NOTE: Junction temperature (T_j) of the device increases with a poor connection to the slug and ground. This reduces the lifetime of the device.

Application Circuit Notes

RF_IN (pin 1): The amplifier requires a DC blocking capacitor as part of the external RF matching.

GND (pin 2): Attach the ground pin to the RF ground plane with the largest diameter and lowest inductance via that the layout allows. Multiple small vias are also acceptable and will work well under the device if solder migration is an issue.

RF_OUT (pin 3): The amplifier requires a DC blocking capacitor as part of the external RF matching. The amplifier collector supply voltage is supplied through an RF choke to the output at pin 3.

GND (pin 4): It is extremely important that the device paddle be sufficiently grounded for both thermal and stability reasons. Multiple small vias are acceptable and will work well under the device if solder migration is an issue.

Testing Procedure

Use the following procedure to set up the SKY65045 Evaluation Board for testing:

1. Connect a 5 V supply to VCC. If available, enable the current limiting function of the power supply to 100 mA.
2. Connect a signal generator to the RF signal input port. Set it to the desired RF frequency at a power level of -15 dBm or less to the Evaluation Board but do NOT enable the RF signal.
3. Connect a spectrum analyzer to the RF signal output port.
4. Enable the power supply.
5. Enable the RF signal.
6. Take measurements.

CAUTION: If any of the output signals exceed the rated maximum values, the SKY65045 Evaluation Board can be permanently damaged.

NOTE: It is important to adjust the VCC voltage source so that +5 V is measured at the board. The high collector currents drop the collector voltage significantly if long leads are used. Adjust the bias voltage to compensate.

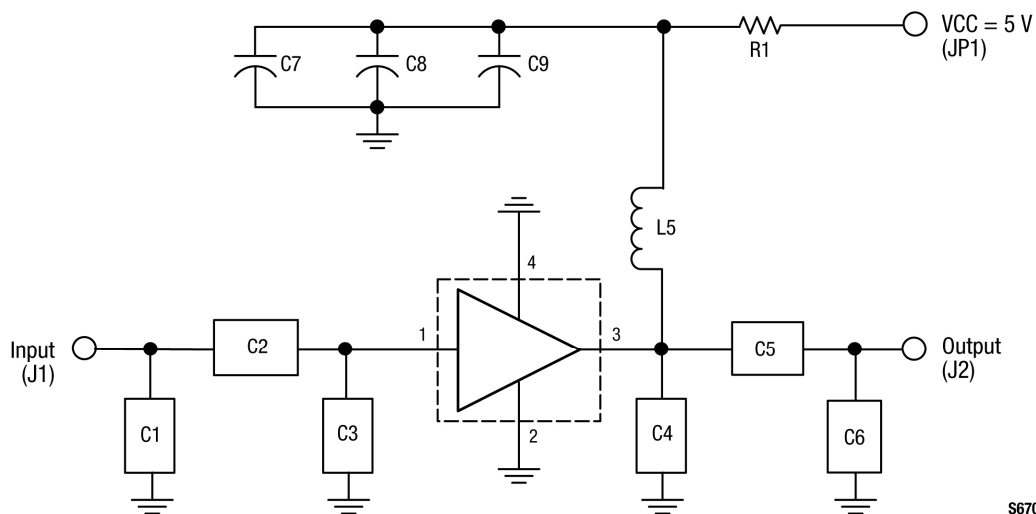
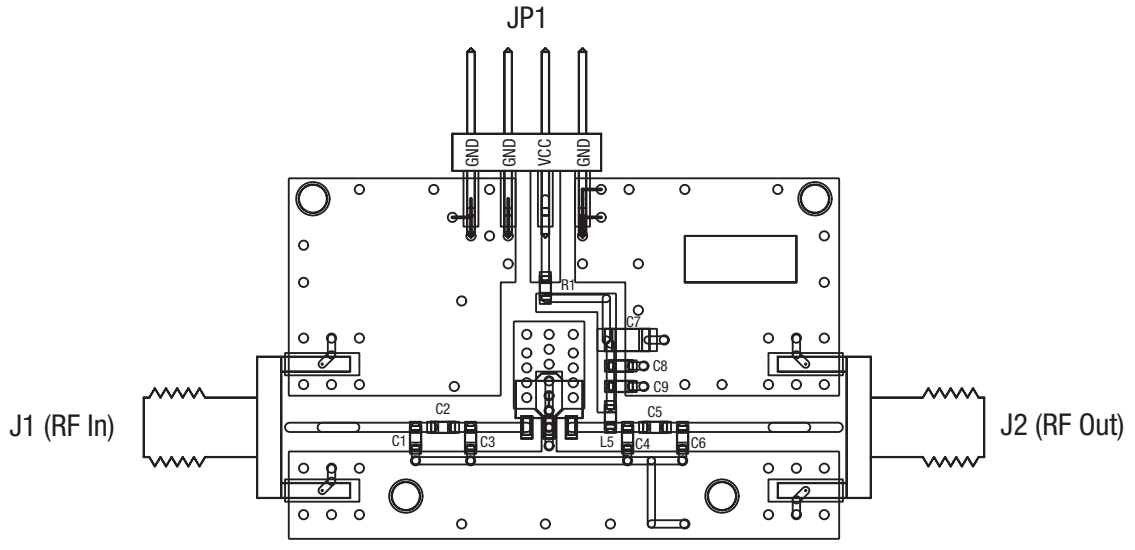
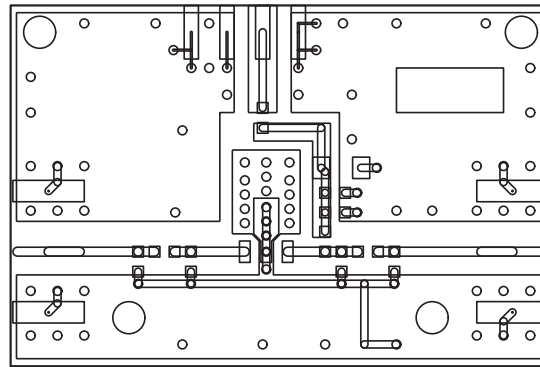

Figure 62. SKY65045 Evaluation Board Assembly Drawing
(Refer to Tables 11 and 12 for Component Values)



S708

Figure 63. SKY65045 Evaluation Board Assembly Drawing



Layer 1: Top - Metal

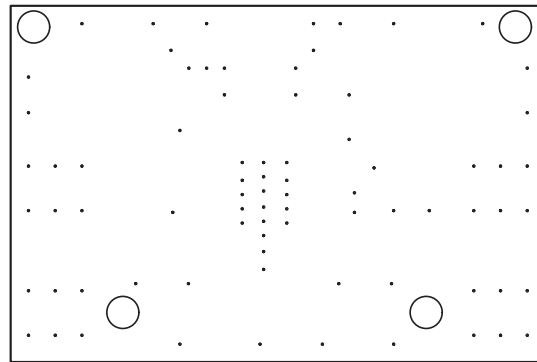

Layer 2: Ground

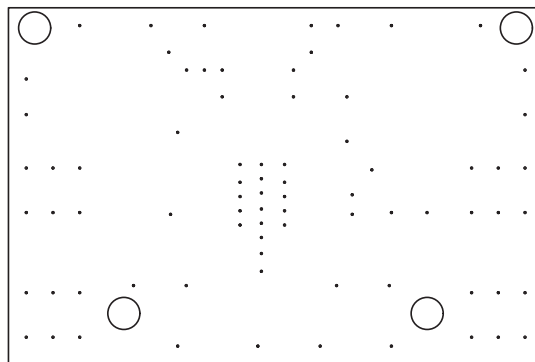

Layer 3: Ground

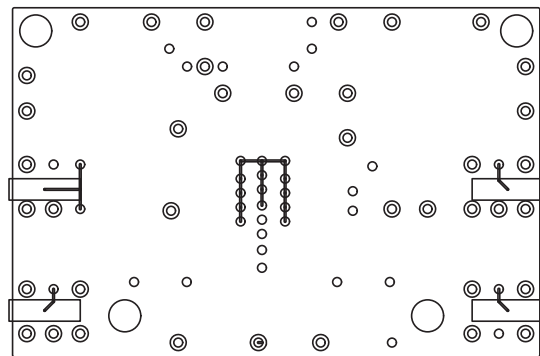

Layer 4: Solid Ground Plane

S709

Figure 64. Evaluation Board Layer Detail

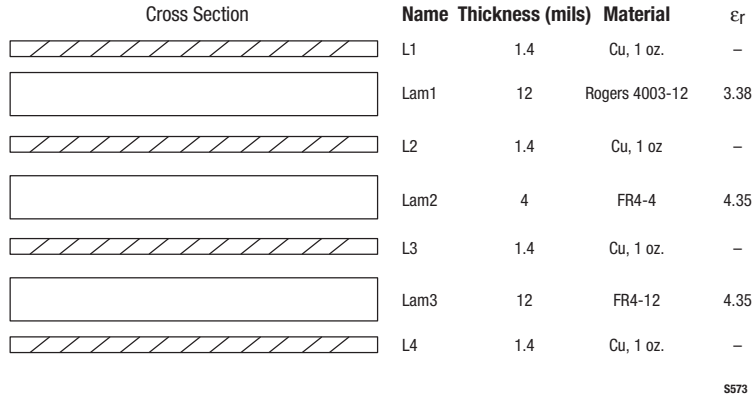

Figure 65. Layer Detail Physical Characteristics

Table 11. SKY65045 Evaluation Board Bill of Materials (747 MHz)

Component	Quantity	Value	Size	Product Number	Manufacturer	Manufacturer's Part Number	Characteristics
R1	1	0 Ω	0603	5424R20-146	Rohm	MCR03EZJ000	50 V, 0.063 Ω , $\pm 5\%$
C7	1	10 μF	0805	5404R29-076	Murata	GRM21BR60J106K	X5R, 50 V, $\pm 20\%$
C8	1	12 pF	0603	5404R23-014	Murata	GRM1885C1H120JD51D	COG, 50 V, $\pm 5\%$
C9	-	DNI	-	-	-	-	-
L5	1	3.3 nH	0603	5332R34-005	Taiyo-Yuden	HK16083N3S-T	± 0.3 nH, SRF 6000 MHz
C1	1	10 nH	0603	5332R34-020	Taiyo-Yuden	HK160810NJ-T	$\pm 5\%$, SRF 3400 MHz
C2	1	4.7 pF	0603	5404R98-006	Murata	GRM1885C1H4R7CZ01D	COG, 50 V, ± 0.25 pF
C3	-	DNI	-	-	-	-	-
C4	-	DNI	-	-	-	-	-
C5	1	4.3 pF	0603	5404R71-022	Murata	-	COG, 50 V, ± 0.25 pF
C6	1	6.8 nH	0603	5332R34-020	Taiyo-Yuden	-	$\pm 5\%$, SRF 3400 MHz

Table 12. SKY65045 Evaluation Board Bill of Materials (897.5 MHz)

Component	Quantity	Value	Size	Product Number	Manufacturer	Manufacturer's Part Number	Characteristics
R1	1	0 Ω	0603	5424R20-146	Rohm	MCR03EZJ000	50 V, 0.063 Ω , $\pm 5\%$
C7	1	1 μF	0805	5404R29-070	TDK	C2012X7R1H104K	X7R, 50 V, $\pm 10\%$
C8	1	1000 pF	0603	5404R23-057	TDK	C1608COG1H102JT	COG, 50 V, $\pm 5\%$
C9	-	DNI	-	-	-	-	-
L5	1	39 nH	0603	5332R34-034	Taiyo-Yuden	HK160839NJ-T	$\pm 5\%$, SRF 1100 MHz
C1	1	DNI	-	-	-	-	-
C2	1	10 pF	0603	5404R23-013	Murata	GRM39COG100JO50AD	COG, 50 V, $\pm 5\%$
C3	1	2.2 pF	0603	5404R23-039	Murata	GRM1885C1H2R2CZ01D	COG, 50 V, ± 0.25 pF
C4	-	DNI	-	-	-	-	-
C5	1	15 pF	0603	5404R23-015	Murata	GRM1885C1H150JD51D	COG, 50 V, $\pm 5\%$
C6	-	DNI	-	-	-	-	-

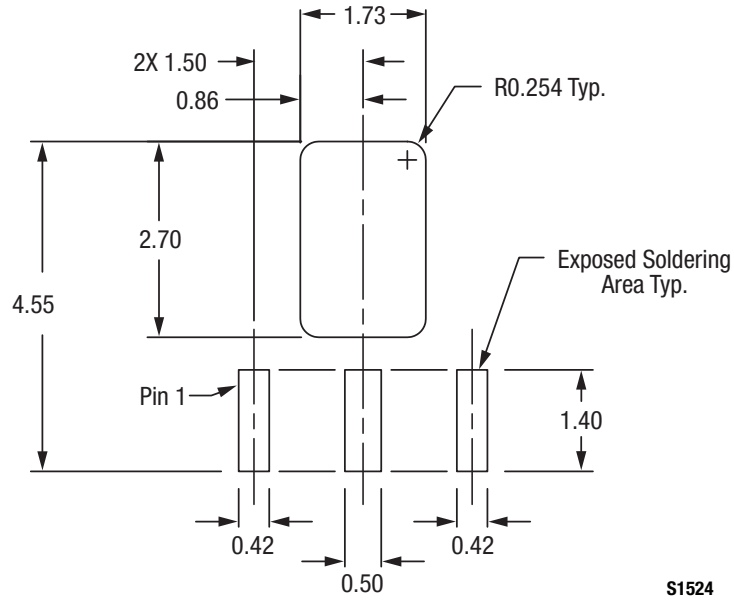
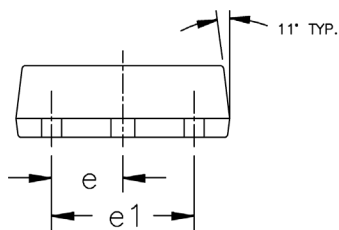
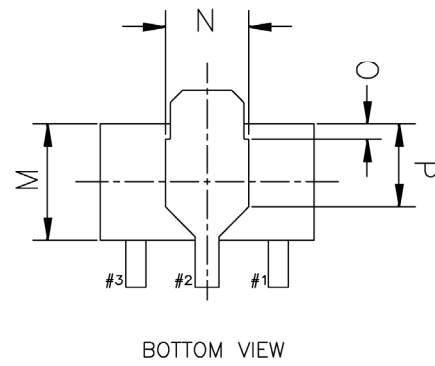
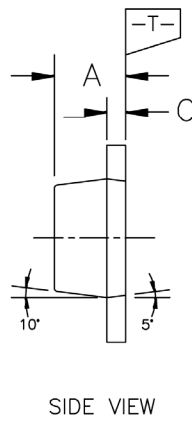
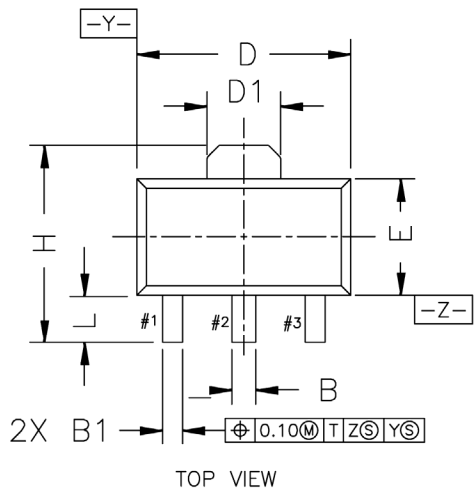

Figure 66. SKY65045-70LF Board Layout Footprint

DATA SHEET • SKY65045-70LF: PA DRIVER



NOTES:

1. DIMENSIONING AND TOLERANCING CONFORM TO ANSI Y14.5M-1982.
2. PACKAGE DIMENSION DOES NOT INCLUDE MOLD PROTRUSIONS OR GATE BURRS. MOLD PROTRUSIONS AND GATE BURRS SHALL NOT EXCEED 0.005" PER END. BODY WIDTH DIMENSION DOES NOT INCLUDE INTERLEAD MOLD PROTRUSIONS. INTERLEAD PROTRUSIONS SHALL NOT EXCEED 0.005" PER SIDE.
3. LEADWIDTH DIMENSION DOES NOT INCLUDE DAMBAR PROTRUSIONS. ALLOWABLE PROTRUSION SHALL NOT EXCEED 0.002" TOTAL IN EXCESS OF LEAD WIDTH DIMENSION AT MAXIMUM MATERIAL CONDITION.
4. PLATING REQUIREMENT PER SOURCE CONTROL DRAWING (SCD) 2504.

DIMENSIONS	COMMON					
	DIMENSIONS MILLIMETER			DIMENSIONS INCH		
	MIN.	NOM.	MAX.	MIN.	NOM.	MAX.
A	1.40	1.50	1.60	0.055	0.059	0.063
B	0.38	0.48	0.58	0.015	0.019	0.023
B1	0.32	0.42	0.52	0.013	0.017	0.020
C	0.35	0.40	0.44	0.014	0.016	0.017
D	4.40	4.50	4.60	0.173	0.177	0.181
D1	1.55 REF			0.061		
E	2.30	2.45	2.60	0.091	0.096	0.102
e	1.50 BSC			0.059 BSC		
e1	3.00 BSC			0.118 BSC		
H	3.94	4.15	4.25	0.155	0.163	0.167
L	0.90	1.00	1.20	0.035	0.039	0.047
M	2.38 REF			0.094		
N	1.75 REF			0.069		
O	0.32 REF			0.013		
P	1.75 REF			0.069		

Figure 67. SKY65045 SOT-89 Package Dimensions

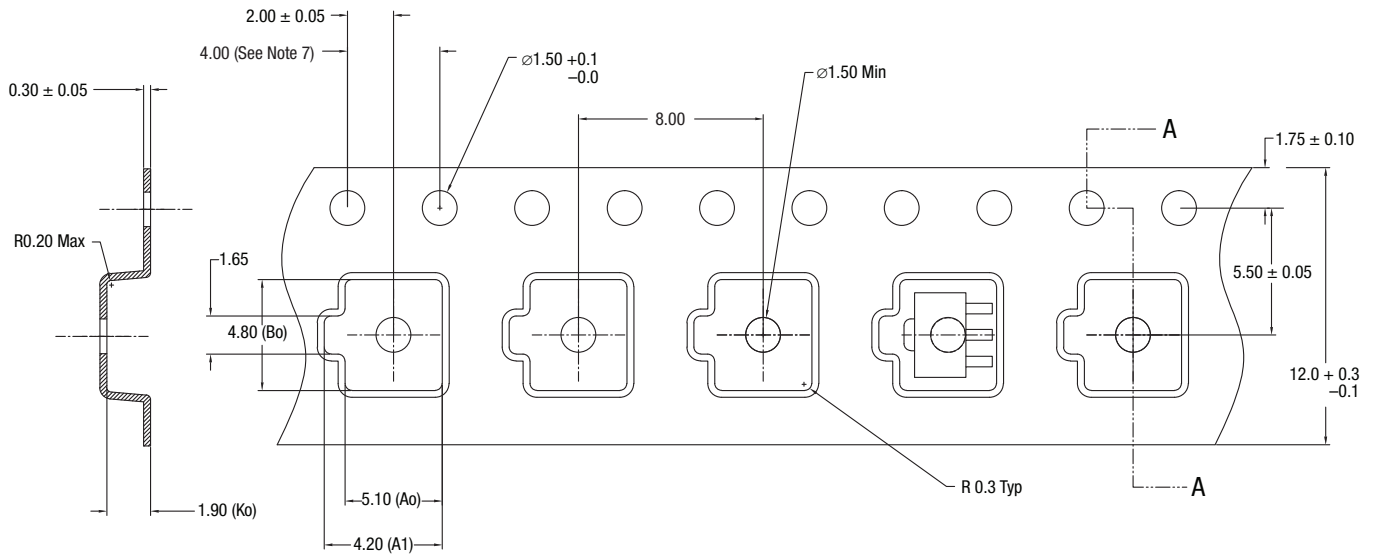

Notes:

1. Carrier tapes must meet all requirements of Skyworks GP01-D233 procurement spec for tape and reel shipping.
2. Carrier tape material: black conductive polycarbonate or polystyrene.
3. Cover tape material: transparent conductive PSA.
Cover tape size: 9.2 mm width.
4. Typical ESD surface resistivity must meet all ESD requirements of Skyworks specified in GP01-D233.
5. Ao and Bo measurement point to be 0.30 mm from bottom pocket.
6. All measurements are in millimeters.
7. 10-sprocket hole pitch cumulative tolerance 0.2 mm.

200953-100

Figure 68. SKY65045 SOT-89 Tape and Reel Dimensions

Ordering Information

Part Number	Product Description	Evaluation Board Part Number
SKY65045-70LF	390 to 1500 MHz Low-Noise PA Driver	SKY65045-70EK1 (747 MHz) SKY65045-70EK2 (897.5 MHz)

Copyright © 2008, 2009, 2012, 2016-2018 Skyworks Solutions, Inc. All Rights Reserved.

Information in this document is provided in connection with Skyworks Solutions, Inc. (“Skyworks”) products or services. These materials, including the information contained herein, are provided by Skyworks as a service to its customers and may be used for informational purposes only by the customer. Skyworks assumes no responsibility for errors or omissions in these materials or the information contained herein. Skyworks may change its documentation, products, services, specifications or product descriptions at any time, without notice. Skyworks makes no commitment to update the materials or information and shall have no responsibility whatsoever for conflicts, incompatibilities, or other difficulties arising from any future changes.

No license, whether express, implied, by estoppel or otherwise, is granted to any intellectual property rights by this document. Skyworks assumes no liability for any materials, products or information provided hereunder, including the sale, distribution, reproduction or use of Skyworks products, information or materials, except as may be provided in Skyworks Terms and Conditions of Sale.

THE MATERIALS, PRODUCTS AND INFORMATION ARE PROVIDED “AS IS” WITHOUT WARRANTY OF ANY KIND, WHETHER EXPRESS, IMPLIED, STATUTORY, OR OTHERWISE, INCLUDING FITNESS FOR A PARTICULAR PURPOSE OR USE, MERCHANTABILITY, PERFORMANCE, QUALITY OR NON-INFRINGEMENT OF ANY INTELLECTUAL PROPERTY RIGHT; ALL SUCH WARRANTIES ARE HEREBY EXPRESSLY DISCLAIMED. SKYWORKS DOES NOT WARRANT THE ACCURACY OR COMPLETENESS OF THE INFORMATION, TEXT, GRAPHICS OR OTHER ITEMS CONTAINED WITHIN THESE MATERIALS. SKYWORKS SHALL NOT BE LIABLE FOR ANY DAMAGES, INCLUDING BUT NOT LIMITED TO ANY SPECIAL, INDIRECT, INCIDENTAL, STATUTORY, OR CONSEQUENTIAL DAMAGES, INCLUDING WITHOUT LIMITATION, LOST REVENUES OR LOST PROFITS THAT MAY RESULT FROM THE USE OF THE MATERIALS OR INFORMATION, WHETHER OR NOT THE RECIPIENT OF MATERIALS HAS BEEN ADVISED OF THE POSSIBILITY OF SUCH DAMAGE.

Skyworks products are not intended for use in medical, lifesaving or life-sustaining applications, or other equipment in which the failure of the Skyworks products could lead to personal injury, death, physical or environmental damage. Skyworks customers using or selling Skyworks products for use in such applications do so at their own risk and agree to fully indemnify Skyworks for any damages resulting from such improper use or sale.

Customers are responsible for their products and applications using Skyworks products, which may deviate from published specifications as a result of design defects, errors, or operation of products outside of published parameters or design specifications. Customers should include design and operating safeguards to minimize these and other risks. Skyworks assumes no liability for applications assistance, customer product design, or damage to any equipment resulting from the use of Skyworks products outside of stated published specifications or parameters.

Skyworks and the Skyworks symbol are trademarks or registered trademarks of Skyworks Solutions, Inc. or its subsidiaries in the United States and other countries. Third-party brands and names are for identification purposes only, and are the property of their respective owners. Additional information, including relevant terms and conditions, posted at www.skyworksinc.com, are incorporated by reference.



Компания «ЭлектроПласт» предлагает заключение долгосрочных отношений при поставках импортных электронных компонентов на взаимовыгодных условиях!

Наши преимущества:

- Оперативные поставки широкого спектра электронных компонентов отечественного и импортного производства напрямую от производителей и с крупнейших мировых складов;
- Поставка более 17-ти миллионов наименований электронных компонентов;
- Поставка сложных, дефицитных, либо снятых с производства позиций;
- Оперативные сроки поставки под заказ (от 5 рабочих дней);
- Экспресс доставка в любую точку России;
- Техническая поддержка проекта, помощь в подборе аналогов, поставка прототипов;
- Система менеджмента качества сертифицирована по Международному стандарту ISO 9001;
- Лицензия ФСБ на осуществление работ с использованием сведений, составляющих государственную тайну;
- Поставка специализированных компонентов (Xilinx, Altera, Analog Devices, Intersil, Interpoint, Microsemi, Aeroflex, Peregrine, Syfer, Eurofarad, Texas Instrument, Miteq, Cobham, E2V, MA-COM, Hittite, Mini-Circuits, General Dynamics и др.);

Помимо этого, одним из направлений компании «ЭлектроПласт» является направление «Источники питания». Мы предлагаем Вам помощь Конструкторского отдела:

- Подбор оптимального решения, техническое обоснование при выборе компонента;
- Подбор аналогов;
- Консультации по применению компонента;
- Поставка образцов и прототипов;
- Техническая поддержка проекта;
- Защита от снятия компонента с производства.



Как с нами связаться

Телефон: 8 (812) 309 58 32 (многоканальный)

Факс: 8 (812) 320-02-42

Электронная почта: org@eplast1.ru

Адрес: 198099, г. Санкт-Петербург, ул. Калинина, дом 2, корпус 4, литера А.